



US00D633576S

(12) **United States Design Patent**
Dalton et al.

(10) **Patent No.:** **US D633,576 S**
(45) **Date of Patent:** **** Mar. 1, 2011**

(54) **DOLL WITH PACIFIER**

(75) Inventors: **Laura Dalton**, St. Louis, MO (US);
Susan Godfrey, Scottsdale, AZ (US)

(73) Assignee: **First Friends, LLC**, St. Louis, MO (US)

(**) Term: **14 Years**

(21) Appl. No.: **29/360,409**

(22) Filed: **Apr. 26, 2010**

(51) **LOC (9) Cl.** **21-01**

(52) **U.S. Cl.** **D21/576; D21/625; D21/655**

(58) **Field of Classification Search** D21/576–578,
D21/585–590, 604–605, 611–612, 625, 655,
D21/658; D24/195; D11/158–159; 446/71–73,
446/97–98, 269, 292, 368–369
See application file for complete search history.

(56) **References Cited**

U.S. PATENT DOCUMENTS

4,277,910	A *	7/1981	Kramer	446/73
D287,636	S *	1/1987	Callju	D24/198
D325,232	S *	4/1992	Phelps	D21/655
5,344,355	A *	9/1994	Silverstein	446/72
D392,697	S *	3/1998	Grasso	D21/605
D402,761	S *	12/1998	Jones	D21/604
5,871,184	A *	2/1999	Kaopio	D21/604
D414,828	S *	10/1999	Sant	D21/612
D415,540	S *	10/1999	Sant	D21/605
D443,065	S *	5/2001	Byes et al.	D24/195
6,666,740	B1	12/2003	Schneider		
6,824,112	B2 *	11/2004	Lange	446/73
D500,817	S *	1/2005	Forte	D21/604

D519,581	S *	4/2006	Velez et al.	D21/611
D522,593	S *	6/2006	Kennedy	D21/655
D609,284	S *	2/2010	Markland et al.	D21/604

* cited by examiner

Primary Examiner—Sandra Morris

(74) *Attorney, Agent, or Firm*—Meschkow & Gresham, P.L.C.

(57) **CLAIM**

The ornamental design for a doll with pacifier, as shown and described.

DESCRIPTION

FIG. 1 is a rear perspective view of a doll with pacifier, showing our new design therefor;

FIG. 2 is front perspective view of the doll with pacifier in FIG. 1;

FIG. 3 is front perspective view of an alternate embodiment of the doll with pacifier in FIG. 1;

FIG. 4 is a side view of the doll with pacifier in FIG. 1; showing the left side, the right side being a mirror image thereof;

FIG. 5 is a front view of the doll with pacifier in FIG. 1;

FIG. 6 is a rear view of the doll with pacifier in FIG. 1;

FIG. 7 is a top view of the doll with pacifier in FIG. 1; and,

FIG. 8 is a bottom view of the doll with pacifier in FIG. 1;

The broken line showing is for illustrative purposes only, and forms no part of the claimed design.

1 Claim, 4 Drawing Sheets

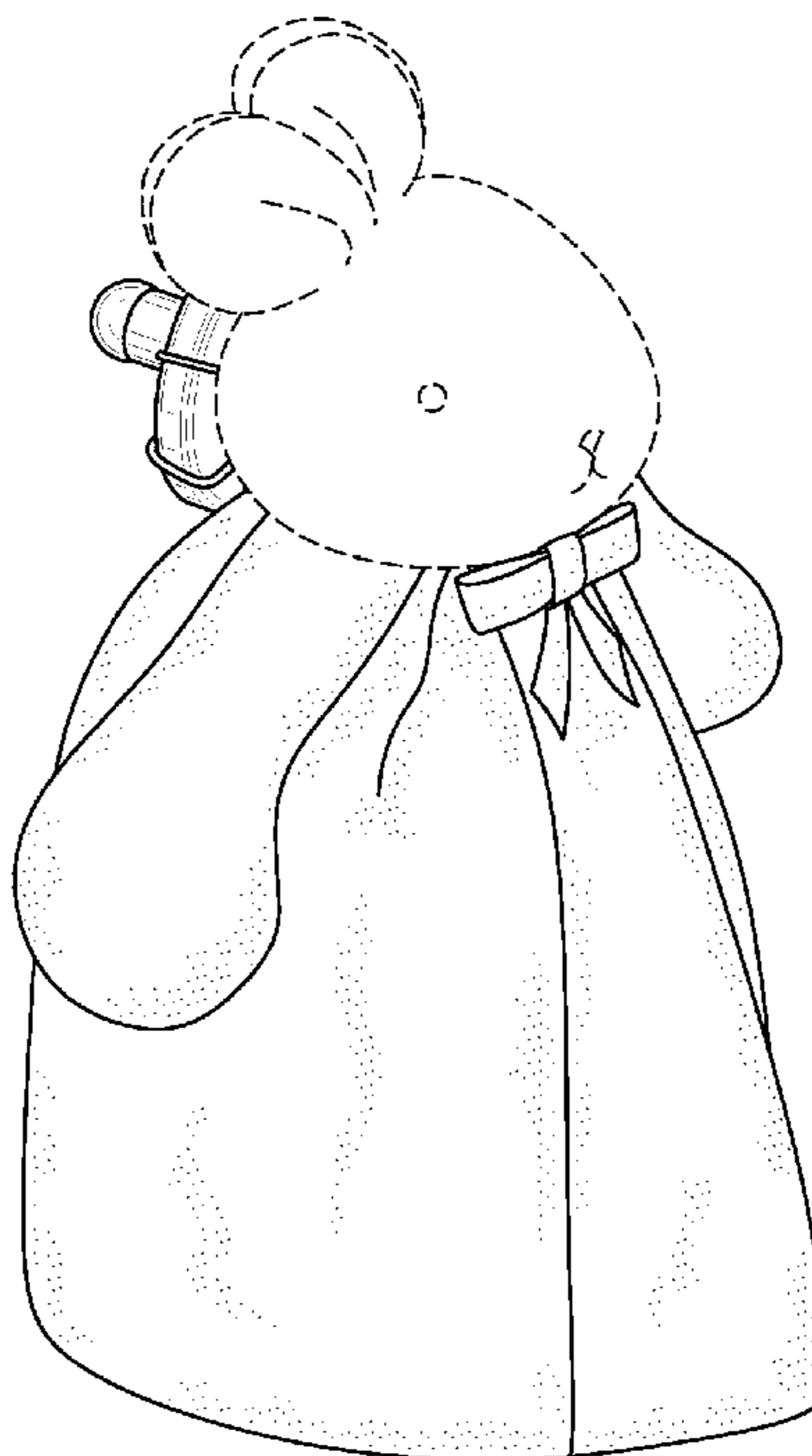

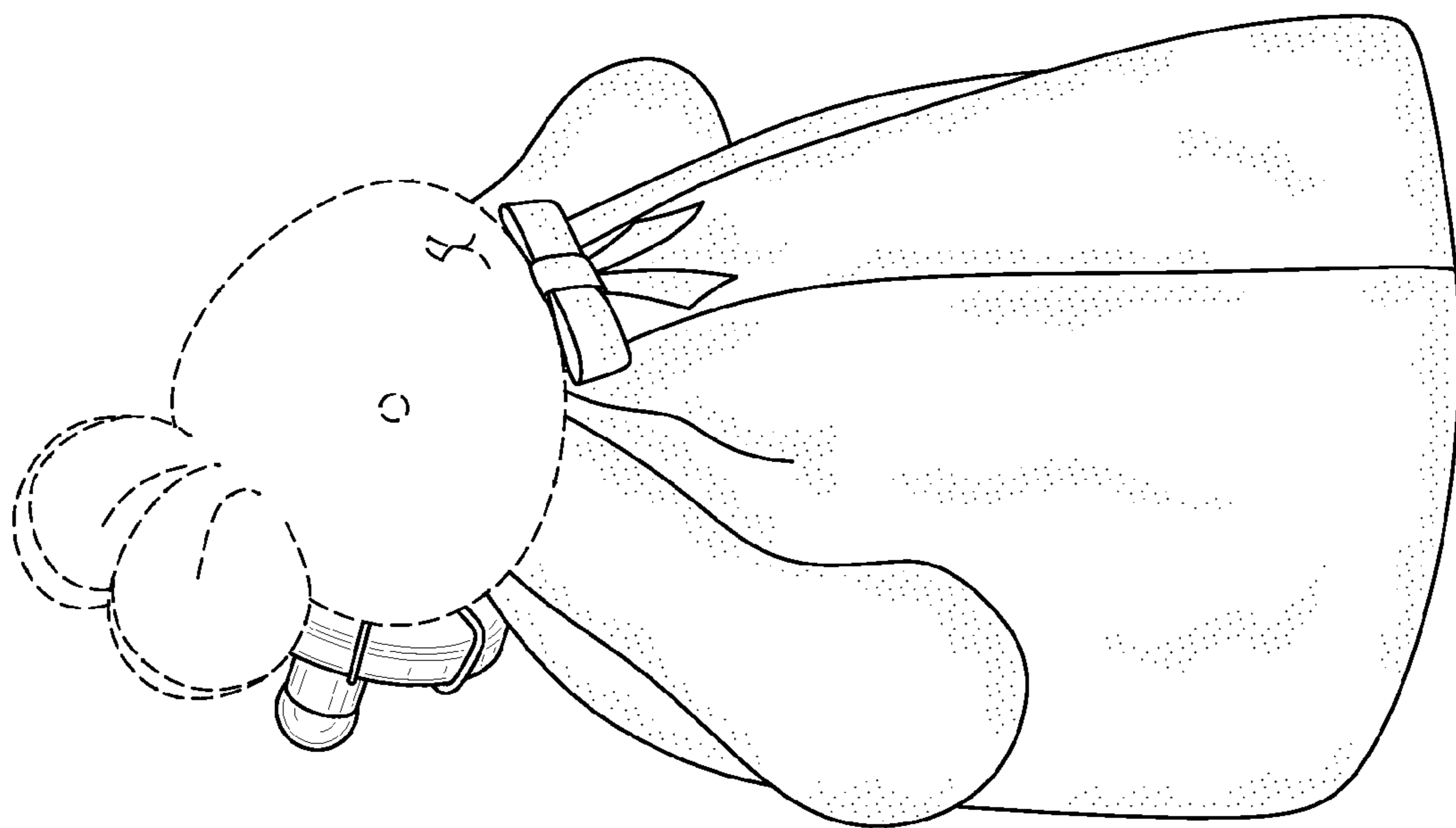

FIG. 2

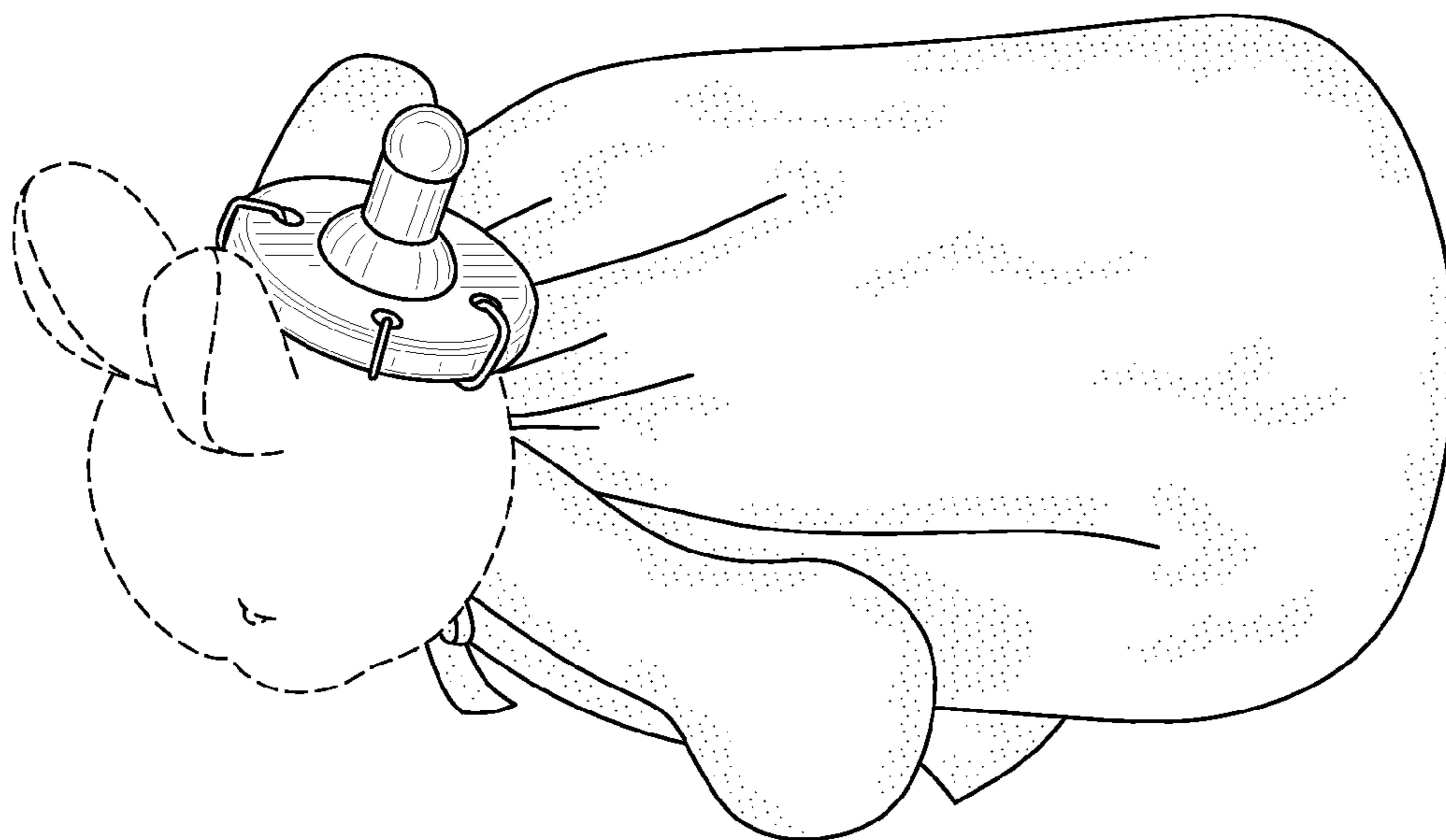

FIG. 1

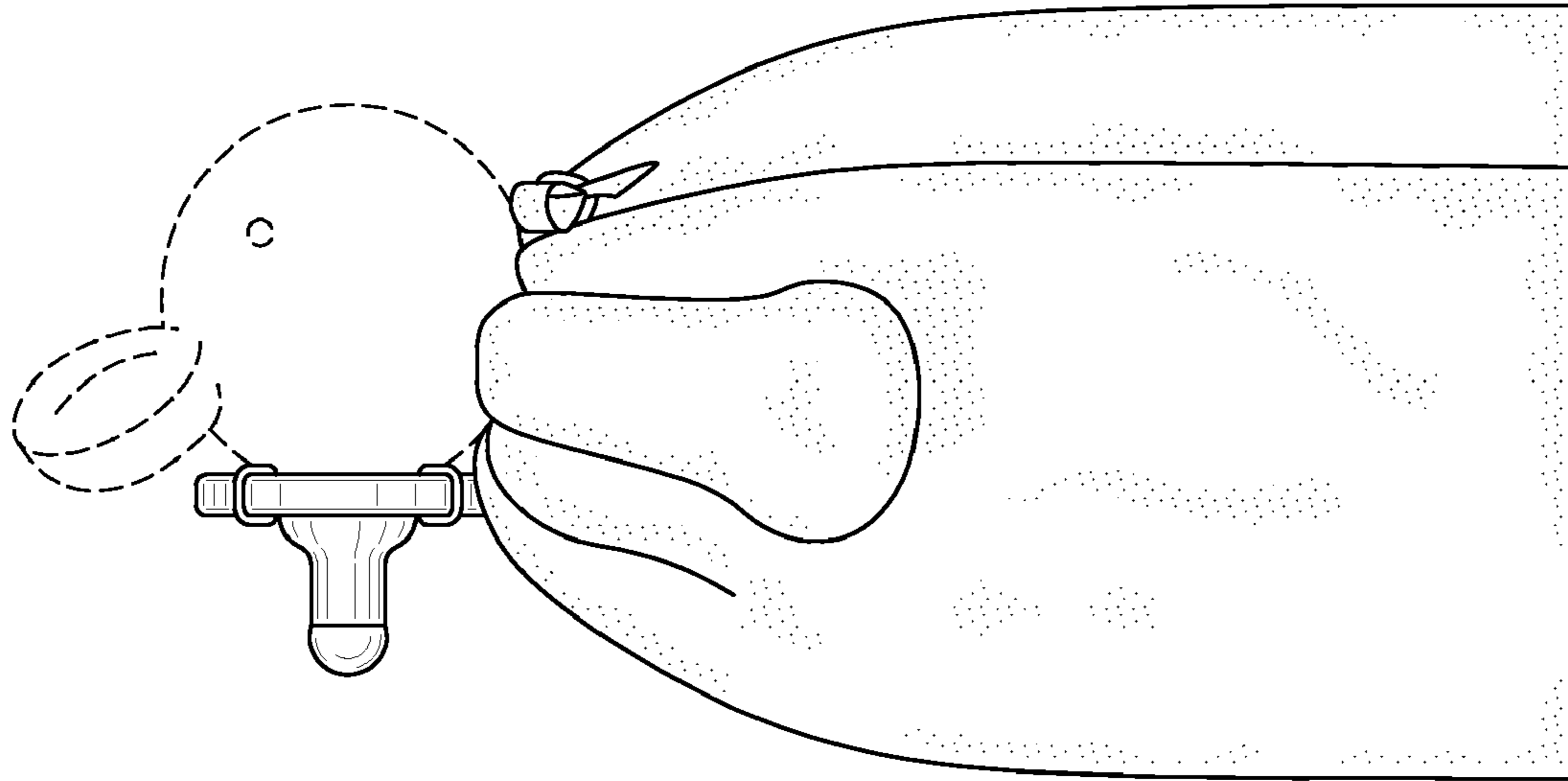

FIG. 4

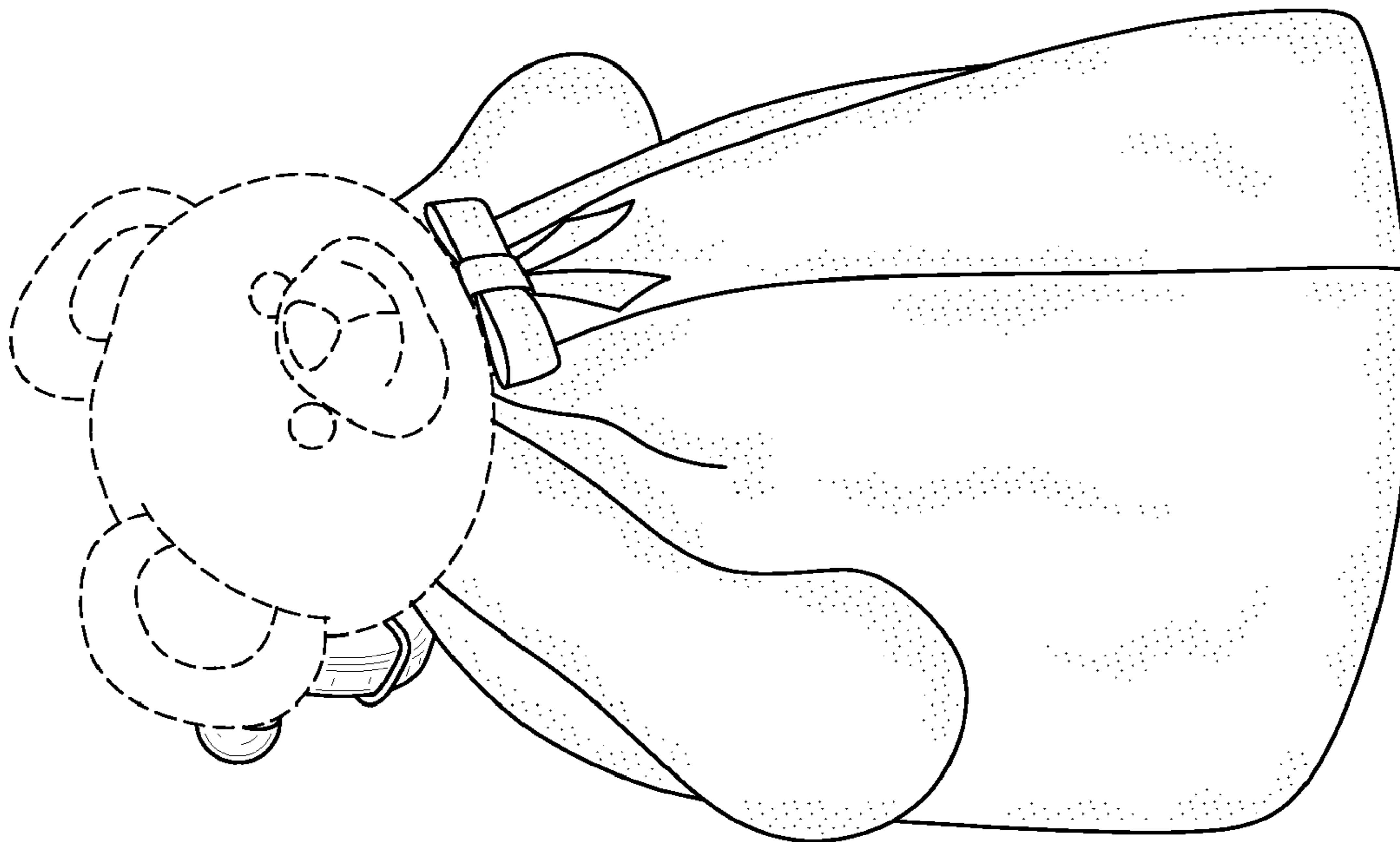

FIG. 3

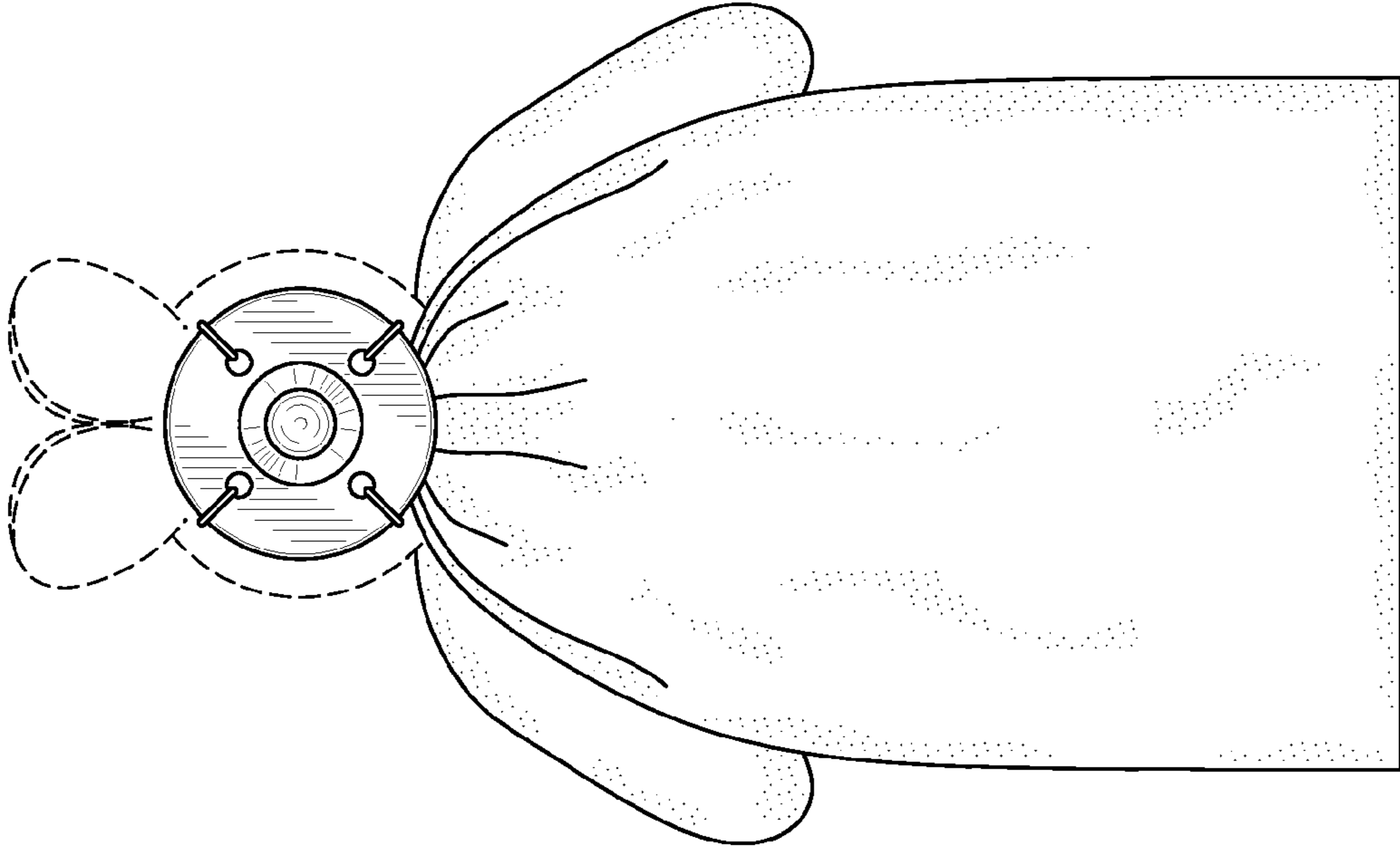

FIG. 6

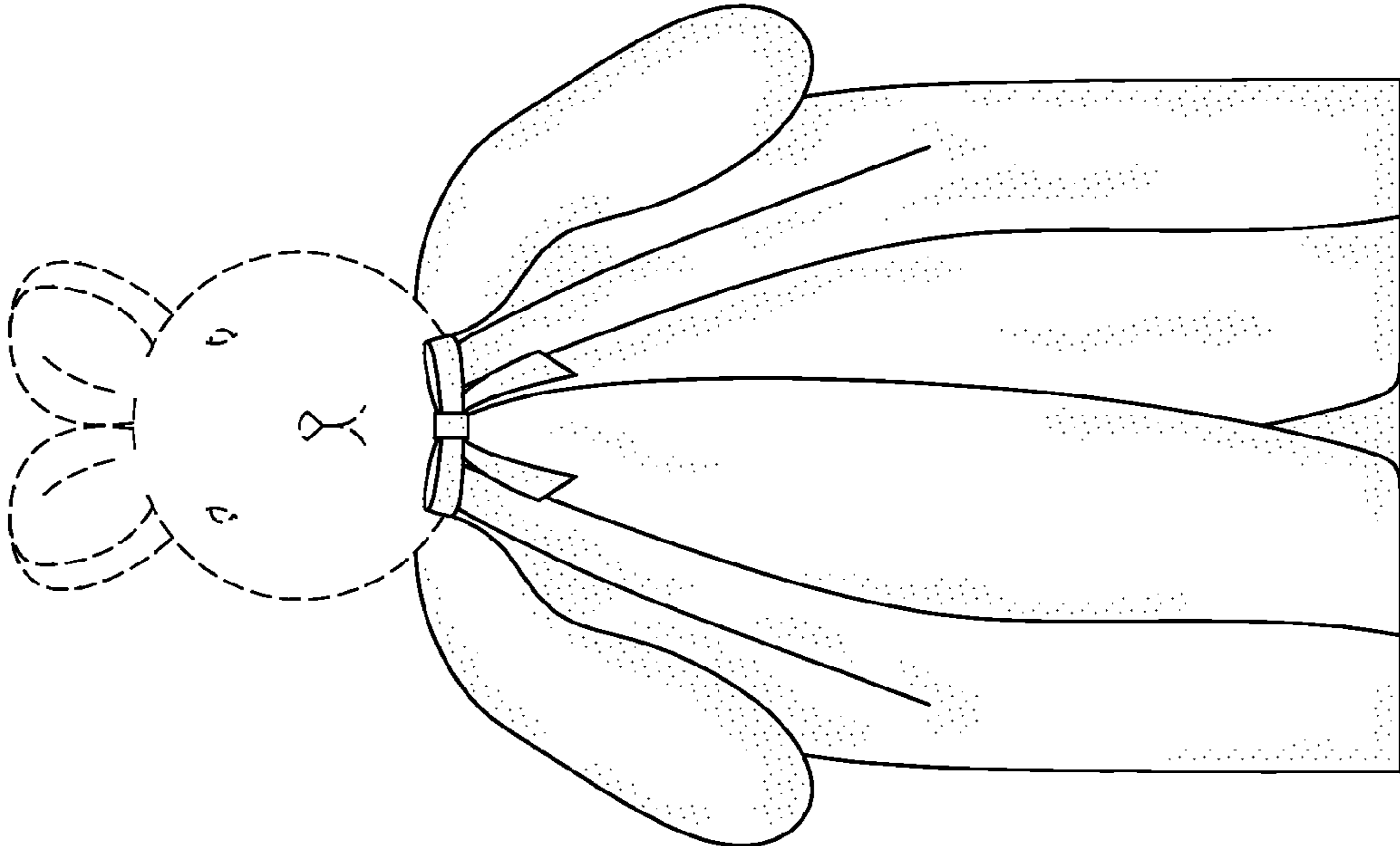

FIG. 5

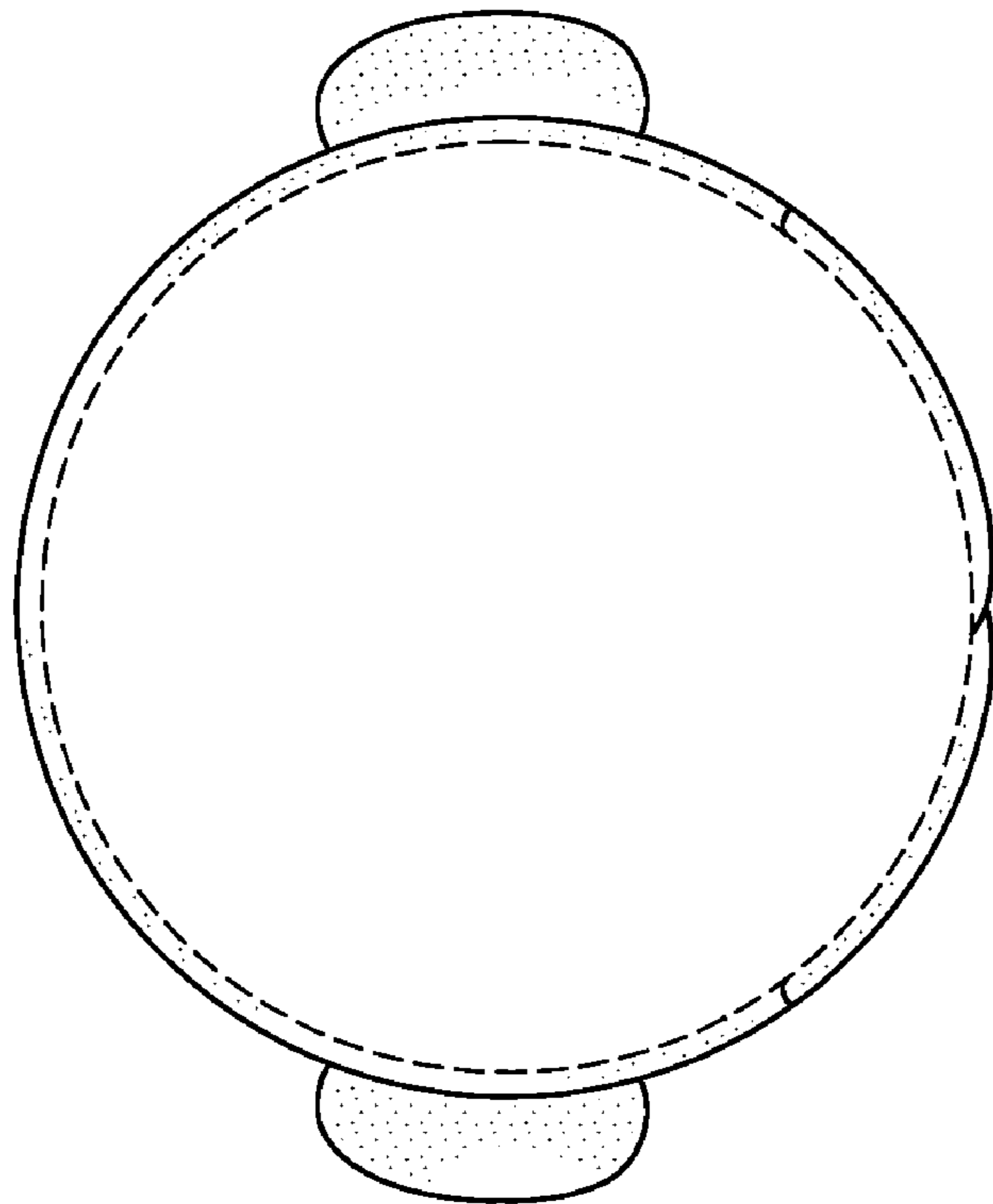

FIG. 8

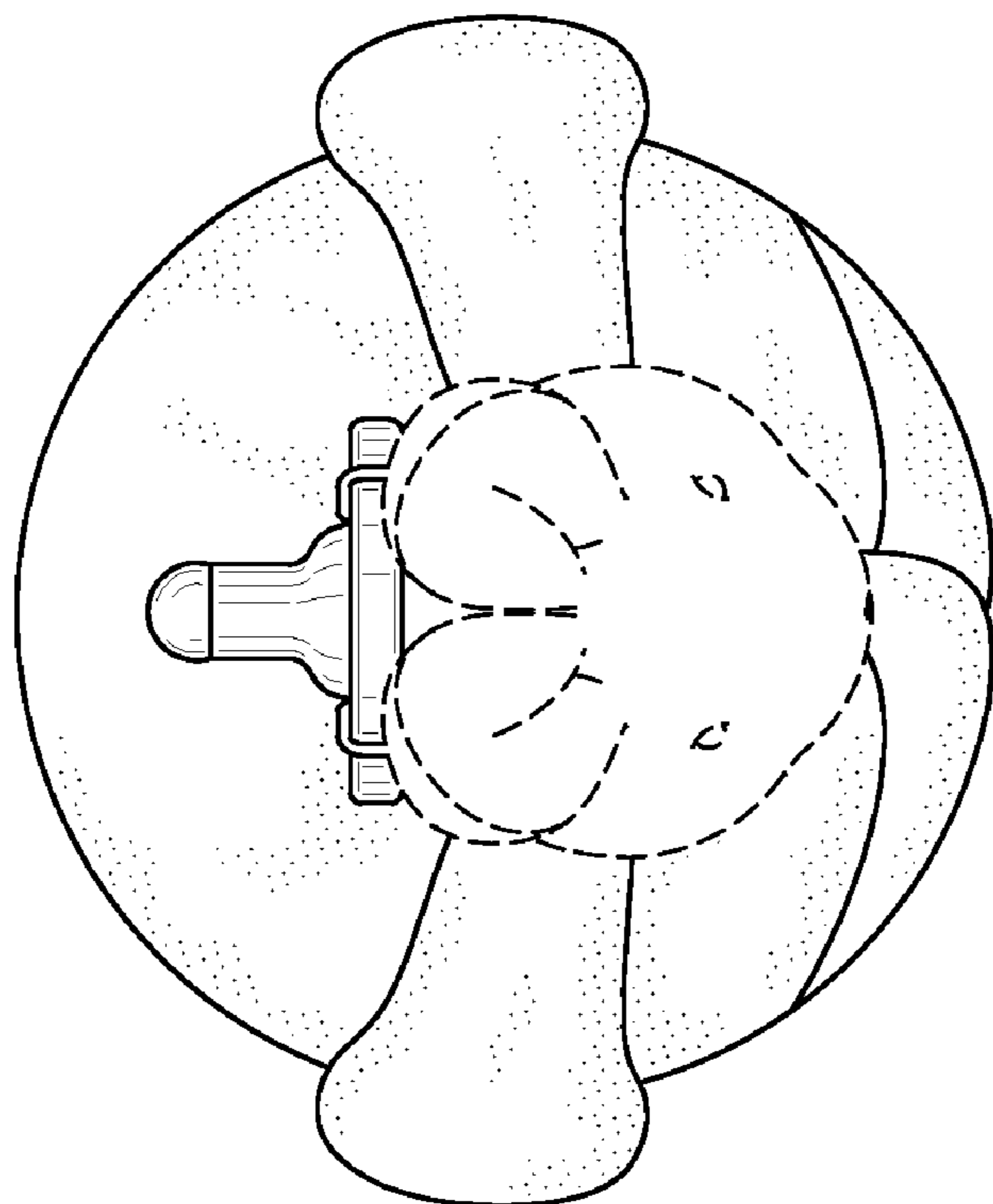

FIG. 7