



US00D633399S

(12) **United States Design Patent**
Zinder

(10) **Patent No.:** **US D633,399 S**

(45) **Date of Patent:** **** *Mar. 1, 2011**

(54) **BRACELET WATCH**

(75) Inventor: **Joshua Zinder**, Princeton, NJ (US)

(73) Assignee: **Joshua Zinder Architecture + Design LLC**, Princeton, NJ (US)

(*) Notice: This patent is subject to a terminal disclaimer.

(**) Term: **14 Years**

(21) Appl. No.: **29/331,499**

(22) Filed: **Jan. 27, 2009**

(51) **LOC (9) Cl.** **10-02**

(52) **U.S. Cl.** **D10/31; D10/32**

(58) **Field of Classification Search** D10/30-39;
368/276, 281, 282, 285, 223, 233, 239, 241,
368/242; 63/7, 8; D11/4, 5

See application file for complete search history.

(56) **References Cited**

U.S. PATENT DOCUMENTS

D4,256	S	*	7/1870	Wessel	D11/4
227,476	A	*	5/1880	Bishop	63/7
1,935,504	A	*	11/1933	Hargreaves	63/7
1,938,206	A	*	12/1933	Bigney	63/7
2,952,967	A	*	9/1960	Nussle	368/281
4,130,987	A	*	12/1978	Schickedanz	368/29
D262,527	S	*	1/1982	Goldberg	D11/2
D317,274	S	*	6/1991	Redina	D11/4
5,214,624	A	*	5/1993	Siebrasse	368/82
5,305,293	A	*	4/1994	Eliachar et al.	368/282
5,418,760	A	*	5/1995	Kawashima et al.	368/69
6,216,490	B1	*	4/2001	Radley-Smith	63/3
6,260,383	B1	*	7/2001	Warren et al.	63/15
D471,471	S	*	3/2003	Fu et al.	D10/32
D495,611	S	*	9/2004	Jørgensen	D10/32
D507,191	S	*	7/2005	Li	D10/31
D533,085	S	*	12/2006	Mourgue	D10/32
7,331,707	B2	*	2/2008	DelValle et al.	368/282
D565,427	S	*	4/2008	Ellner et al.	D10/31

D570,711	S	*	6/2008	Dorsz	D10/32
7,460,085	B2	*	12/2008	Ishii	345/1.1
7,518,959	B2	*	4/2009	Akaiwa et al.	368/82
D600,570	S	*	9/2009	Zinder	D10/31
D600,571	S	*	9/2009	Singer	D10/32
7,639,571	B2	*	12/2009	Ishii et al.	368/82

* cited by examiner

Primary Examiner—Lucy Lieberman

(74) *Attorney, Agent, or Firm*—Mayer & Williams PC; Mark K. Young

(57) **CLAIM**

The ornamental design for a bracelet watch, as shown and described.

DESCRIPTION

FIG. 1 is a front view of a bracelet watch showing my new design;

FIG. 2 is bottom view thereof;

FIG. 3 is a back view thereof;

FIG. 4 is top view thereof;

FIG. 5 is a left side view thereof;

FIG. 6 is a right side view thereof;

FIG. 7 is a perspective view of the bracelet watch with the time display moved to a first representative position;

FIG. 8 is a perspective view of the bracelet watch with the time display moved to second representative position;

FIG. 9 is a perspective view of the bracelet watch with the time display moved to a third representative position;

FIG. 10 is a front view of the bracelet watch in an open position;

FIG. 11 is a bottom view thereof;

FIG. 12 is a back view thereof;

FIG. 13 is a top view thereof; and,

FIG. 14 is a perspective view thereof.

1 Claim, 7 Drawing Sheets

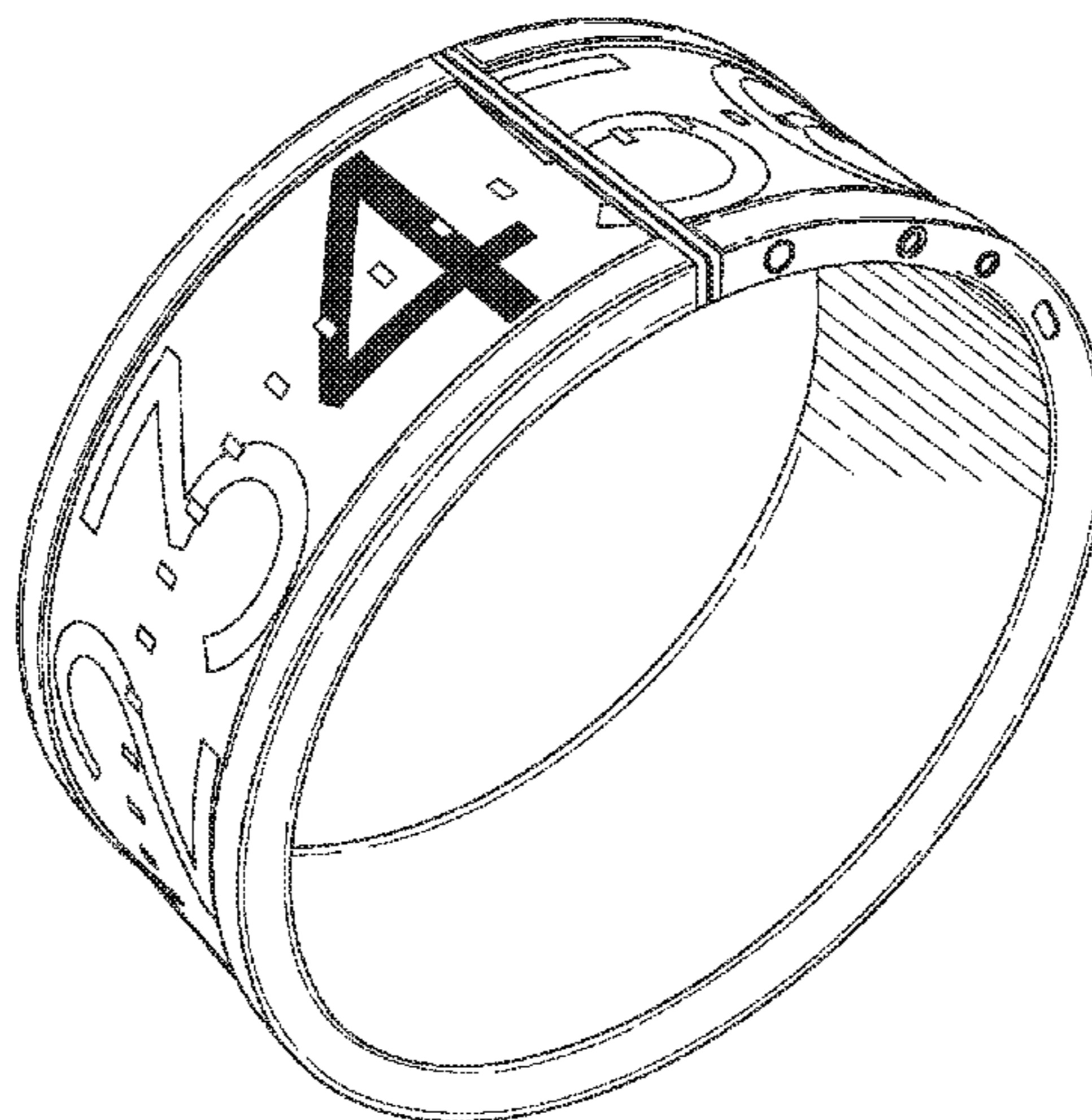

FIG. 1

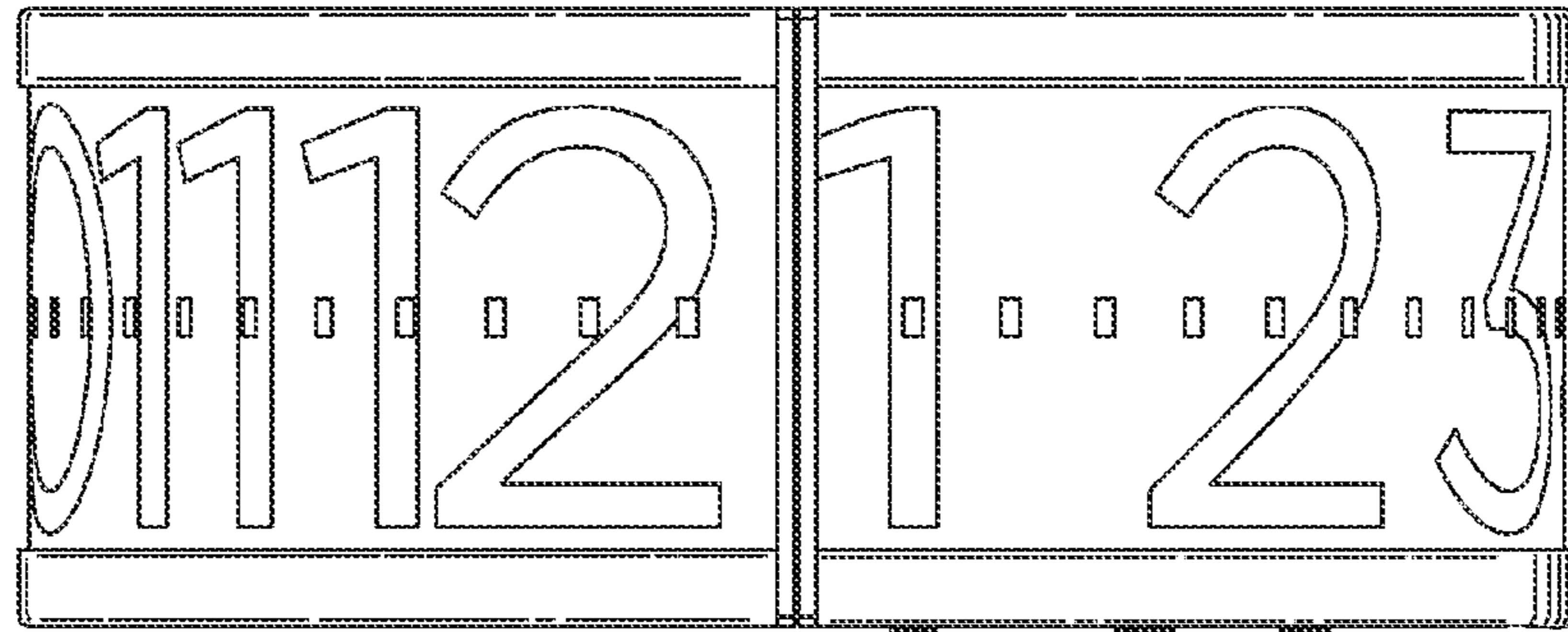

FIG. 2

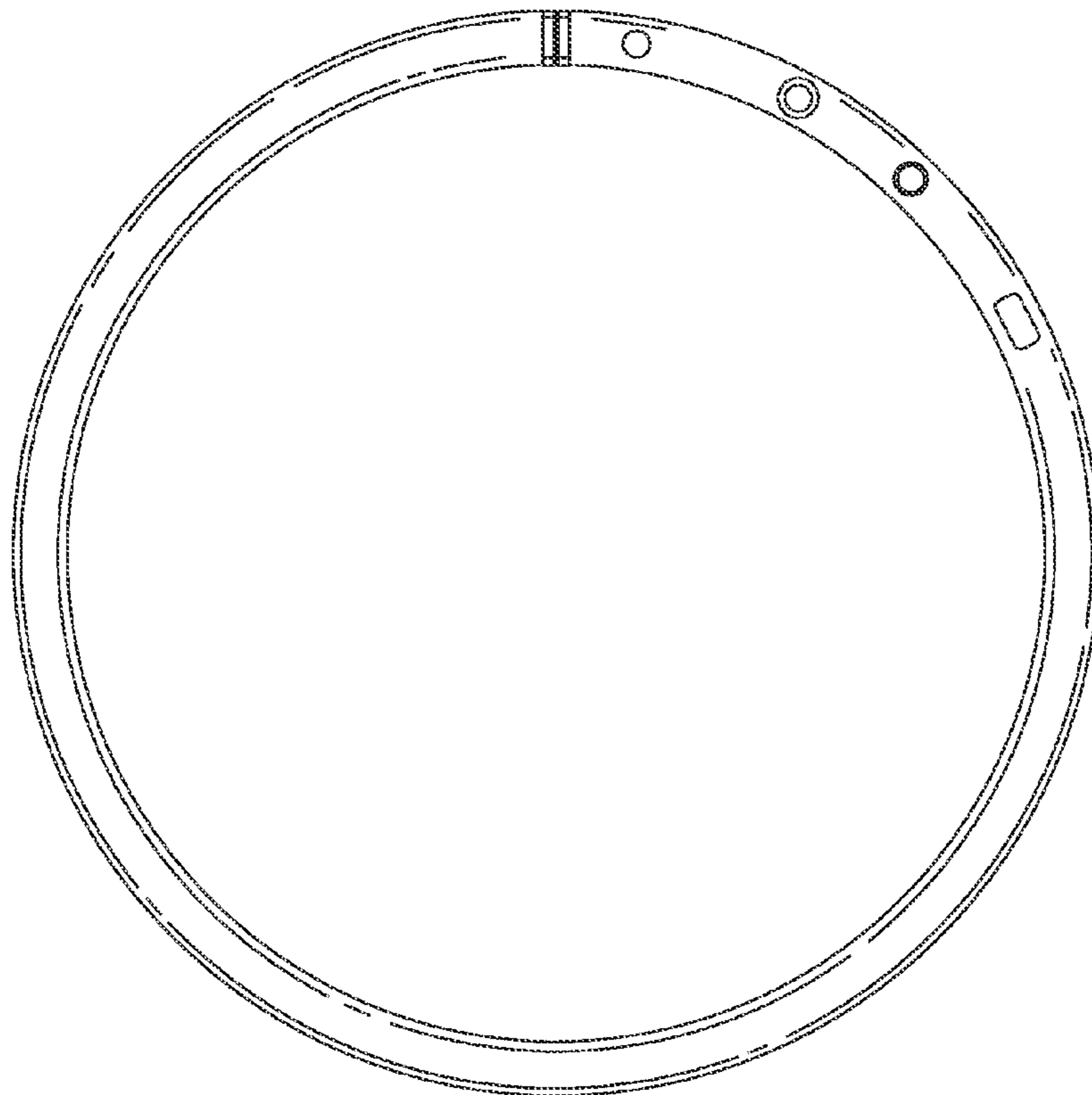

FIG. 3

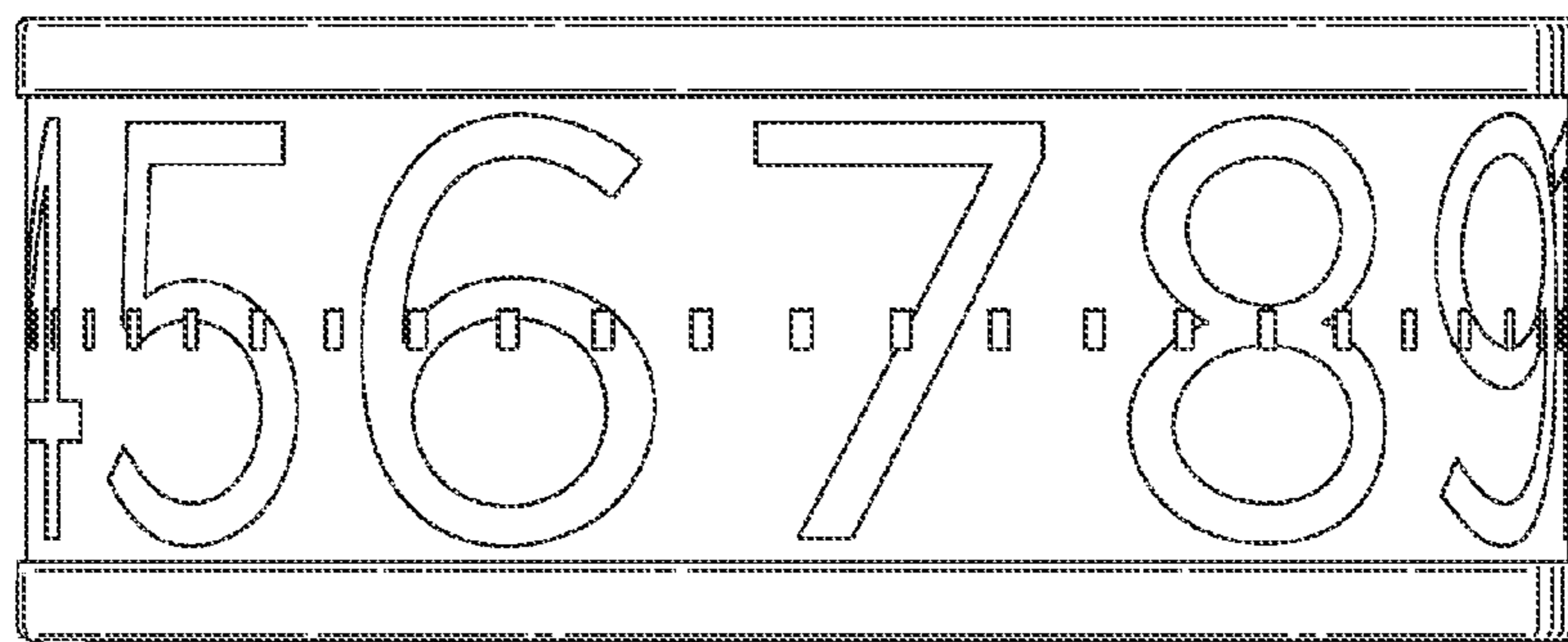

FIG. 4

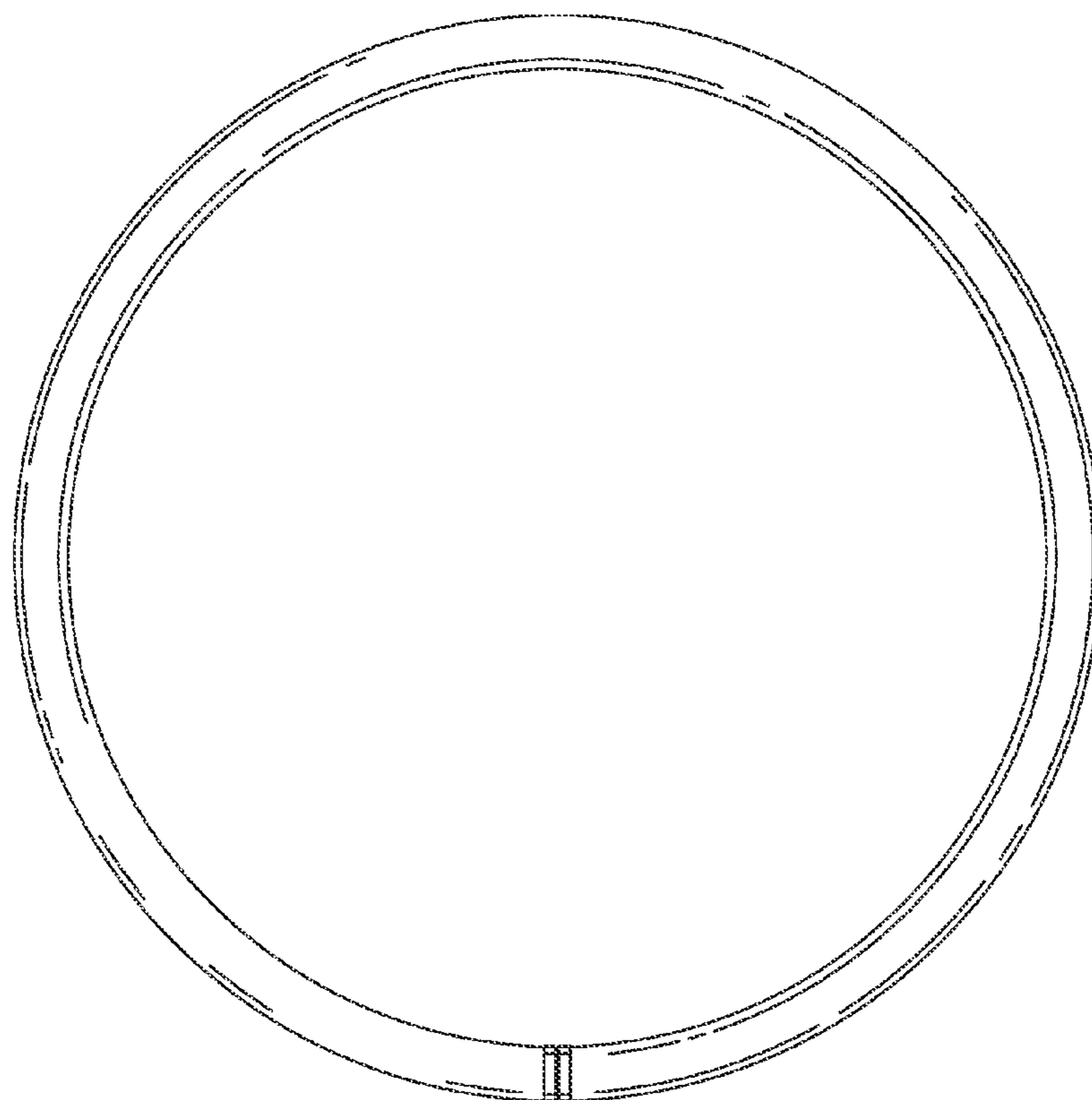

FIG. 5

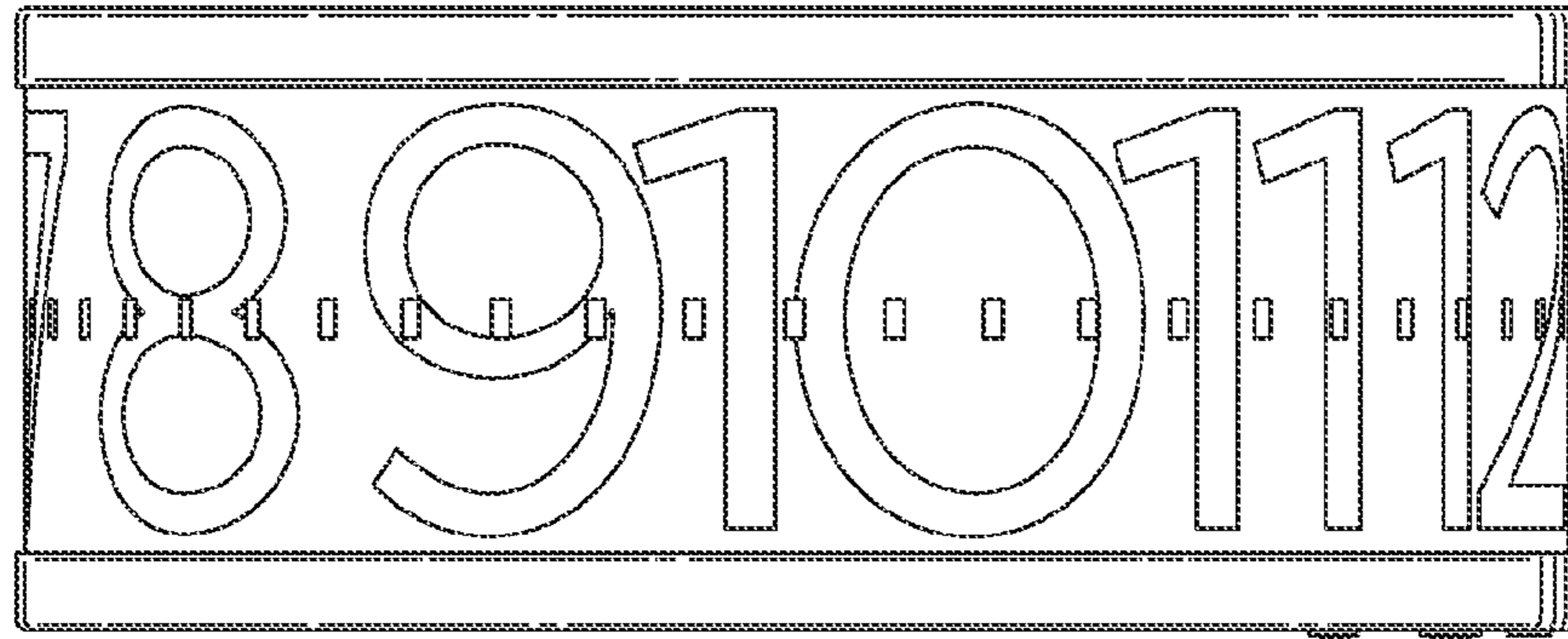

FIG. 6

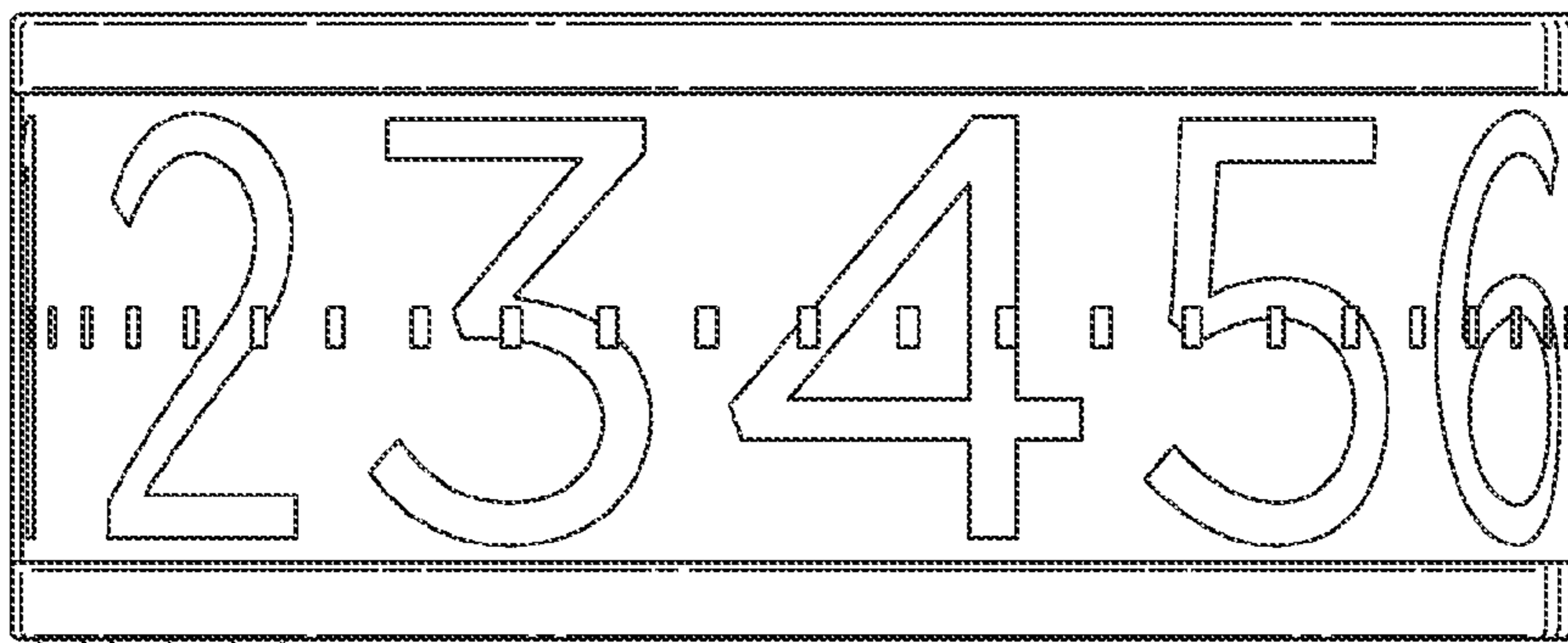

FIG. 7

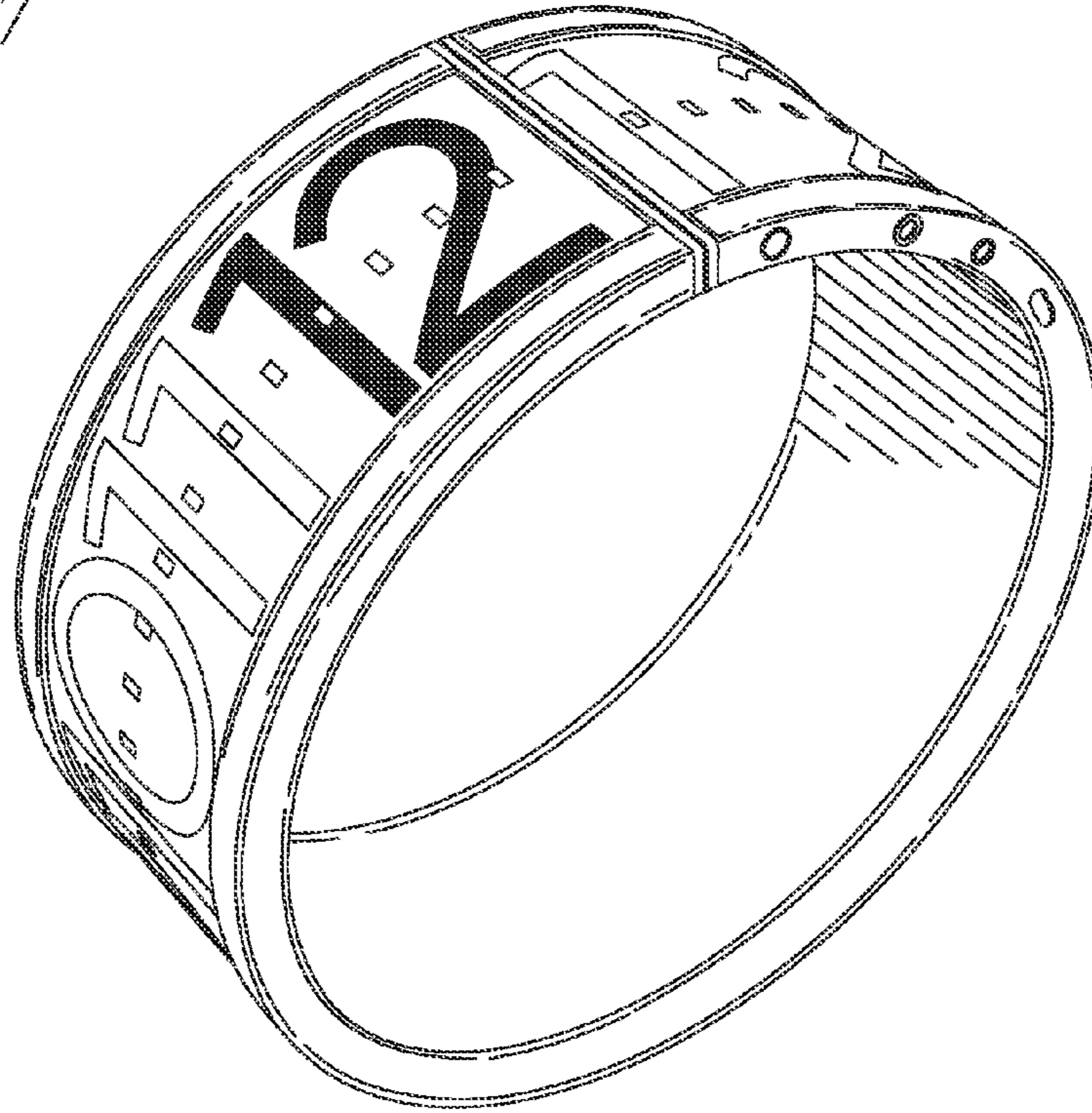

FIG. 8

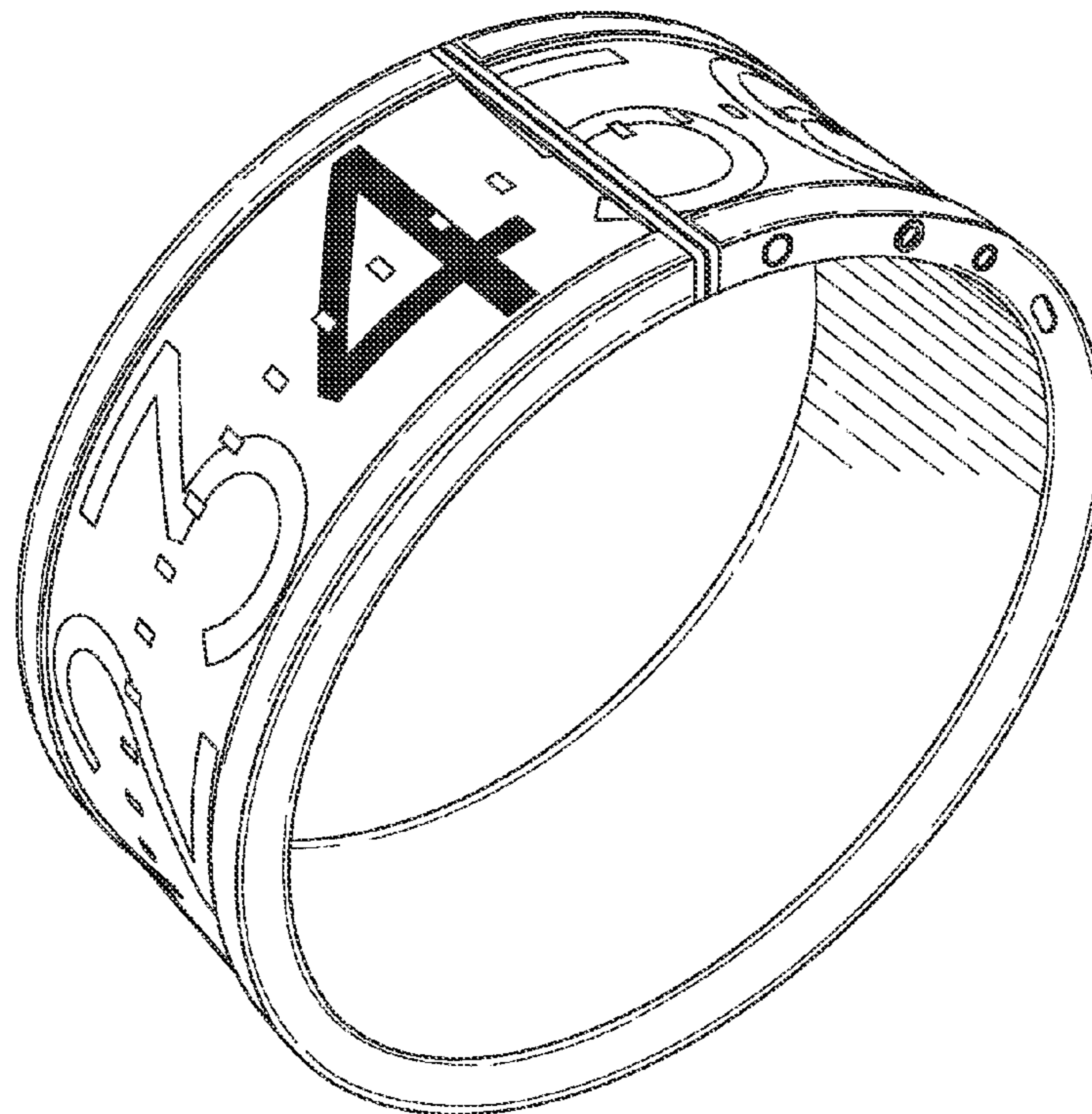

FIG. 9

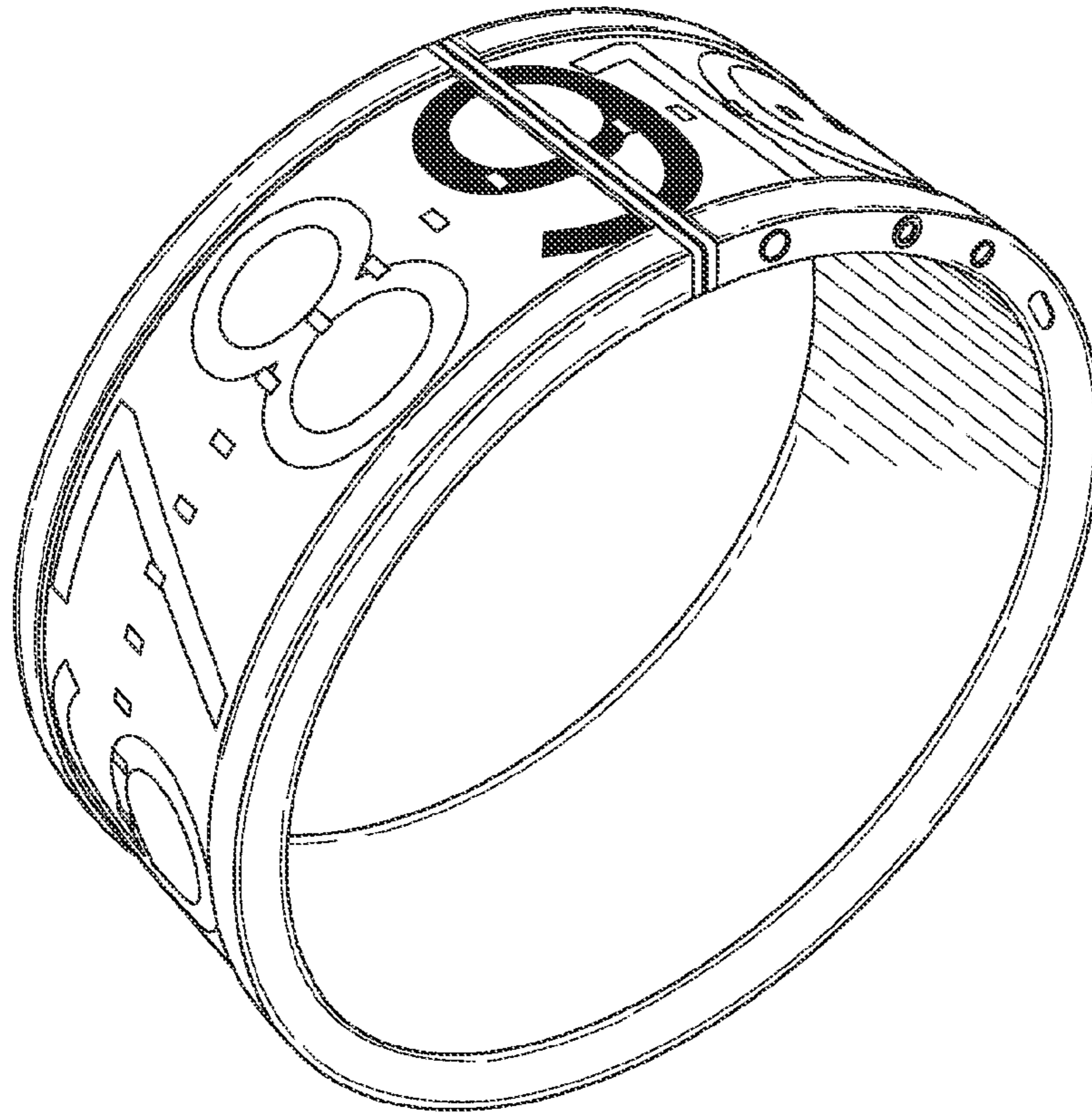

FIG. 10

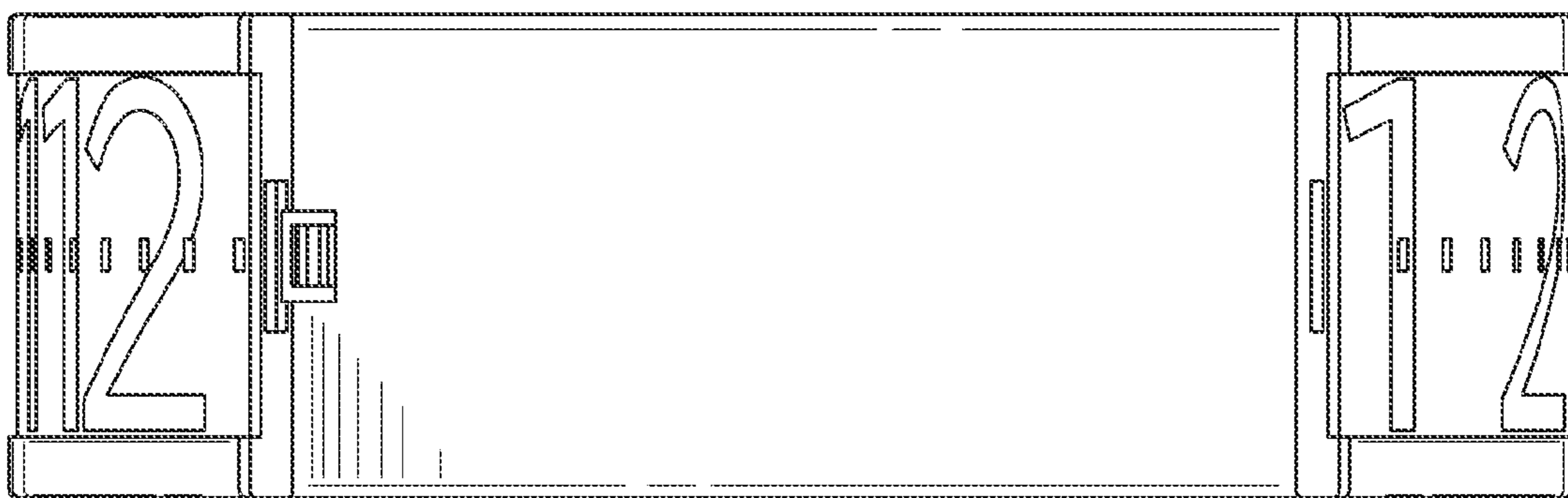

FIG. 11

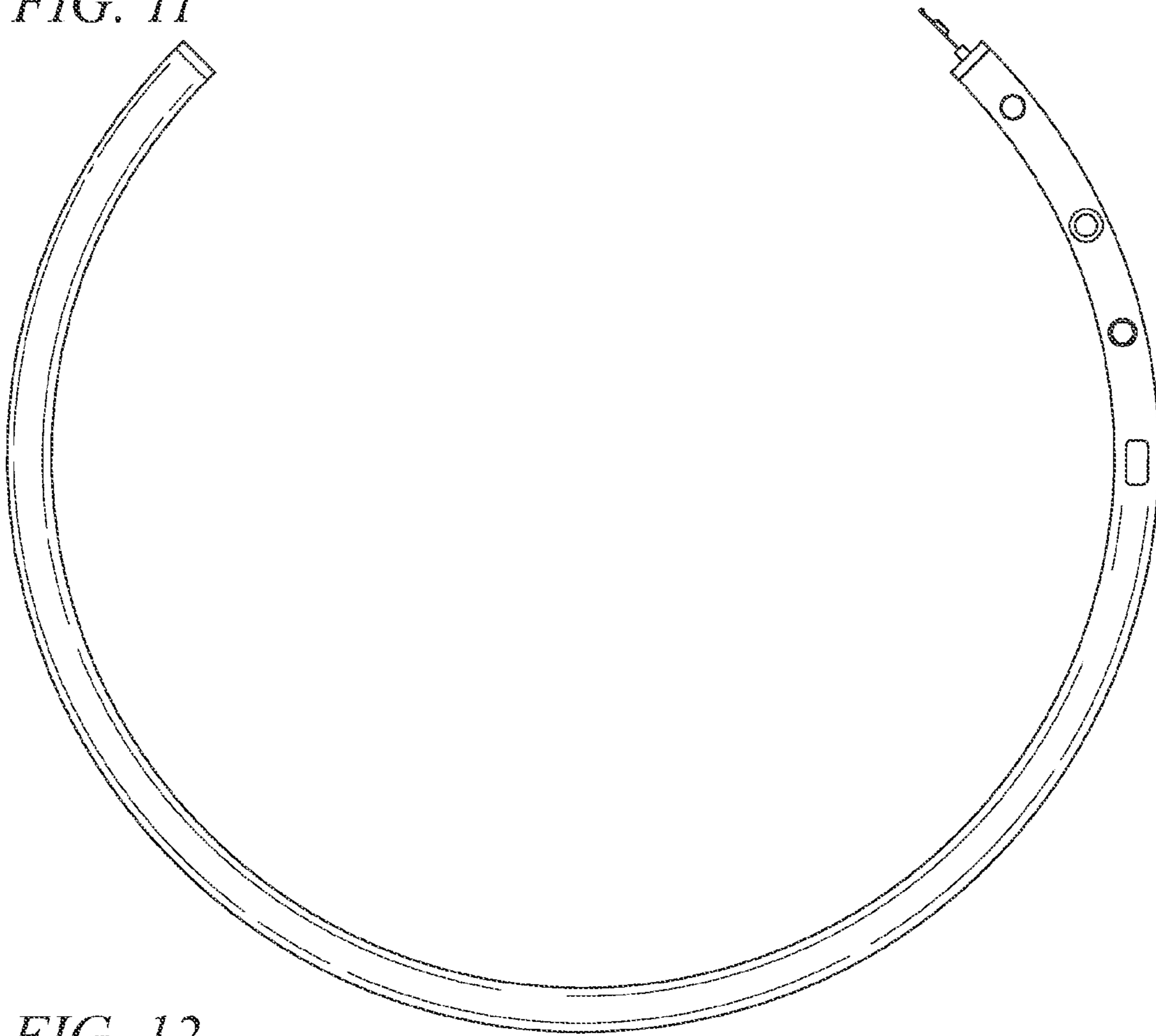

FIG. 12

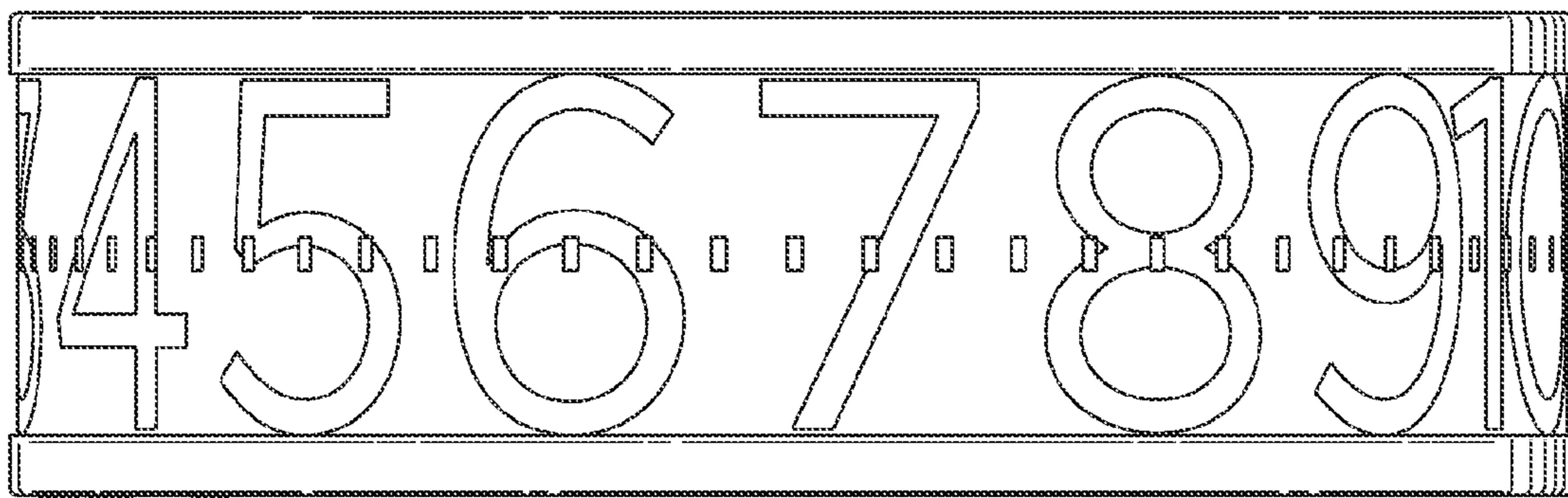

FIG. 13

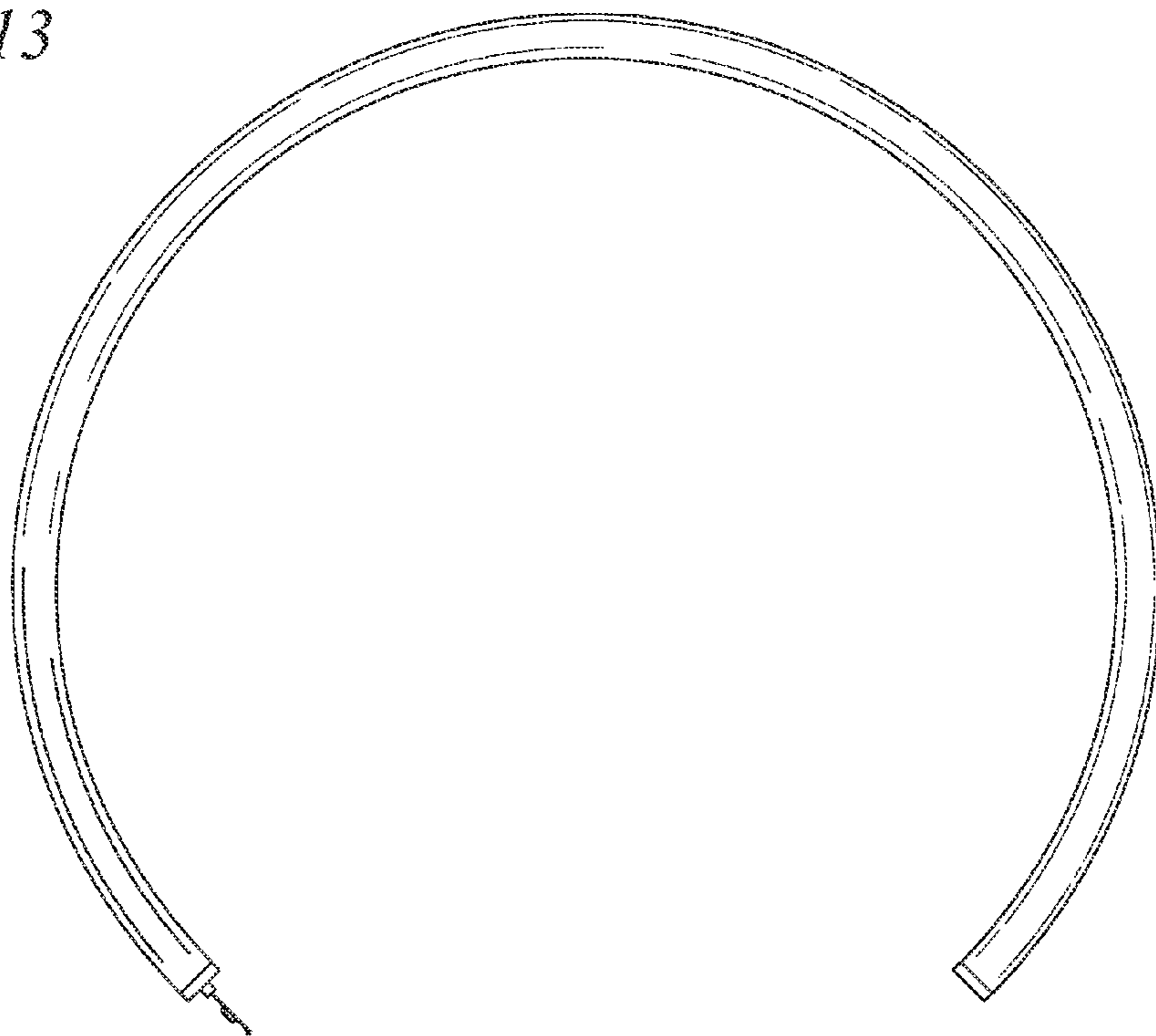

FIG. 14

