



US00D633398S

(12) **United States Design Patent**  
**Stowers et al.**

(10) **Patent No.:** **US D633,398 S**  
(45) **Date of Patent:** **\*\* Mar. 1, 2011**

(54) **RAZOR TRAY**

(75) Inventors: **David C. Stowers**, Morristown, NJ (US);  
**Jeffrey W. Wonderley**, Fort Defiance,  
VA (US); **Edward D. Furrow**,  
Waynesboro, VA (US)

(73) Assignee: **American Safety Razor**, Verona, VA  
(US)

(\*\*) Term: **14 Years**

(21) Appl. No.: **29/328,950**

(22) Filed: **Dec. 4, 2008**

(51) **LOC (9) Cl.** ..... **09-01**

(52) **U.S. Cl.** ..... **D9/749**

(58) **Field of Classification Search** ..... 206/208,  
206/228, 244, 252, 349, 354-360, 493, 775;  
D28/17, 19, 44, 99; D3/201, 205; D9/415,  
D9/424, 429, 730, 735, 736, 737, 748, 749;  
D6/512, 526

See application file for complete search history.

(56) **References Cited**

**U.S. PATENT DOCUMENTS**

4,373,628	A *	2/1983	Dantes	.....	206/349
D313,175	S	12/1990	Motta et al.		
5,429,241	A	7/1995	Althaus		
D366,611	S	1/1996	Poisson		
5,518,114	A	5/1996	Kohring et al.		
D397,290	S *	8/1998	Petricca et al.	.....	D9/736
5,867,907	A	2/1999	Terry et al.		
5,946,805	A	9/1999	Oldroyd		
6,041,926	A *	3/2000	Petricca et al.	.....	206/356
6,052,903	A	4/2000	Metcalf et al.		
6,192,586	B1	2/2001	Metcalf et al.		
6,415,517	B1	7/2002	Worrick, III		
6,499,595	B1	12/2002	Petricca		
6,886,690	B2	5/2005	Petricca		
7,040,024	B2	5/2006	Lukan et al.		
D531,518	S	11/2006	Ramm et al.		
D533,466	S *	12/2006	Wonderley et al.	.....	D9/749
7,159,324	B2	1/2007	Worrick, III		

D561,610	S *	2/2008	Renaldi et al.	.....	D9/749
D572,150	S *	7/2008	Stowers et al.	.....	D9/749
D594,762	S *	6/2009	Stowers et al.	.....	D9/749
D596,953	S *	7/2009	Wonderley et al.	.....	D9/749
2002/0184770	A1	12/2002	Peysner		
2005/0198825	A1	9/2005	Apprille		
2007/0007155	A1	1/2007	Foster		

**FOREIGN PATENT DOCUMENTS**

EP	1 577 228	A1	2/1998
GB	2 245 859	A	1/1992
GB	2 437 358	A	10/2007
JP	64-22204		1/1989
JP	64-83206		3/1989
JP	7-222619		8/1995

(Continued)

*Primary Examiner*—Thomas J Johannes

(74) *Attorney, Agent, or Firm*—McDermott Will & Emery  
LLP

(57) **CLAIM**

An ornamental design for a razor tray, as shown and described.

**DESCRIPTION**

FIG. 1 is a top perspective view of a razor tray showing our new design;

FIG. 2 is a top view thereof;

FIG. 3 is a bottom view thereof;

FIG. 4 is a side view thereof;

FIG. 5 is another side view thereof;

FIG. 6 is a rear view thereof; and,

FIG. 7 is a front view thereof.

The broken line portion of the figure drawings is included to show unclaimed subject matter only and forms no part of the claimed design; the portions of the design surrounded by dot-dash broken lines show claim boundaries only and form no part of the claimed design.

**1 Claim, 6 Drawing Sheets**

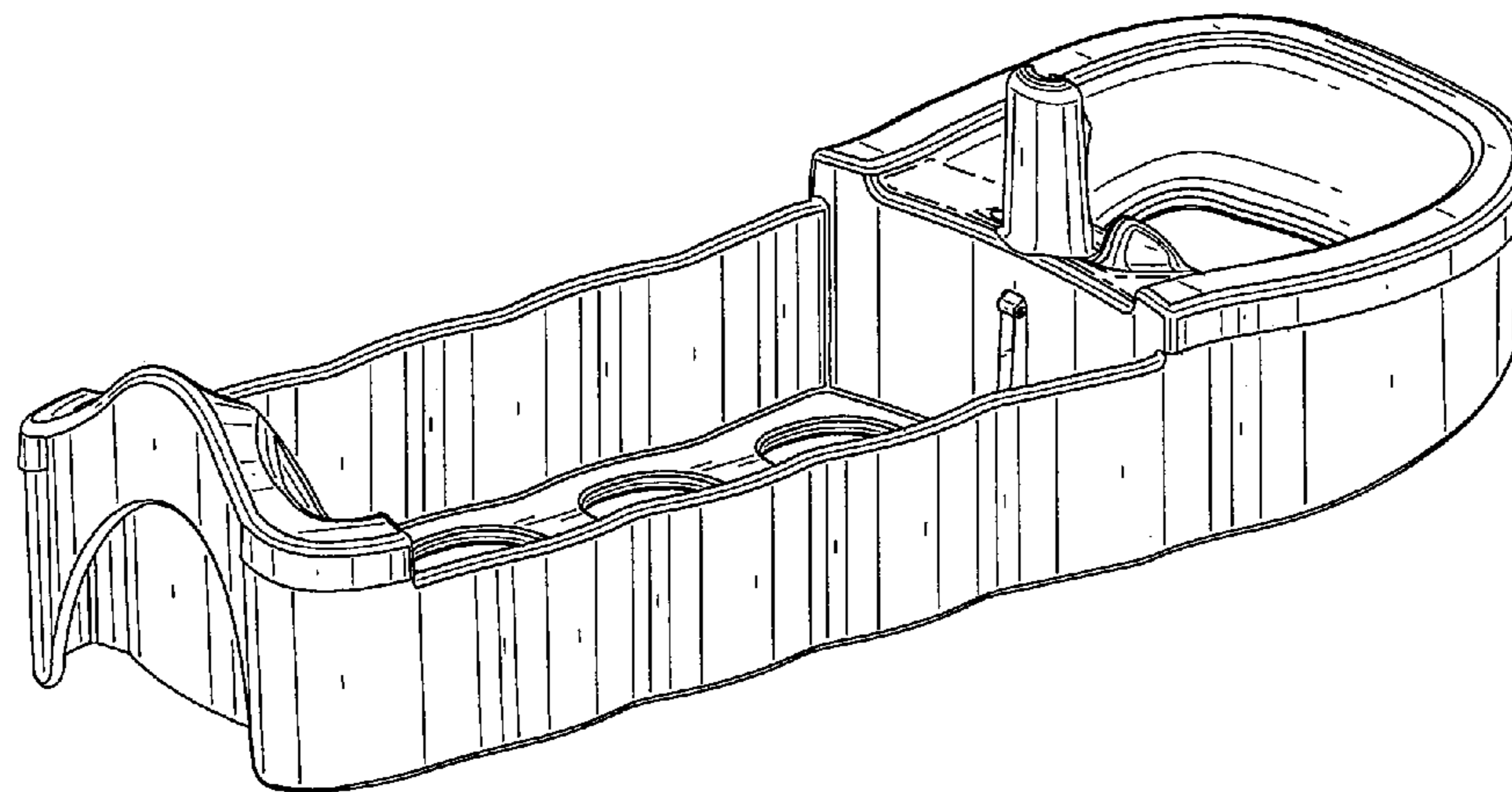

# US D633,398 S

Page 2

---

FOREIGN PATENT DOCUMENTS					
			JP	2003-24121	1/2003
			JP	2006-75188	3/2006
JP	7-227487	8/1995	JP	2006-232325	9/2006
JP	2001-2132	1/2001	WO	WO 98/36879	8/1998
JP	2001-310088	11/2001			
			* cited by examiner		

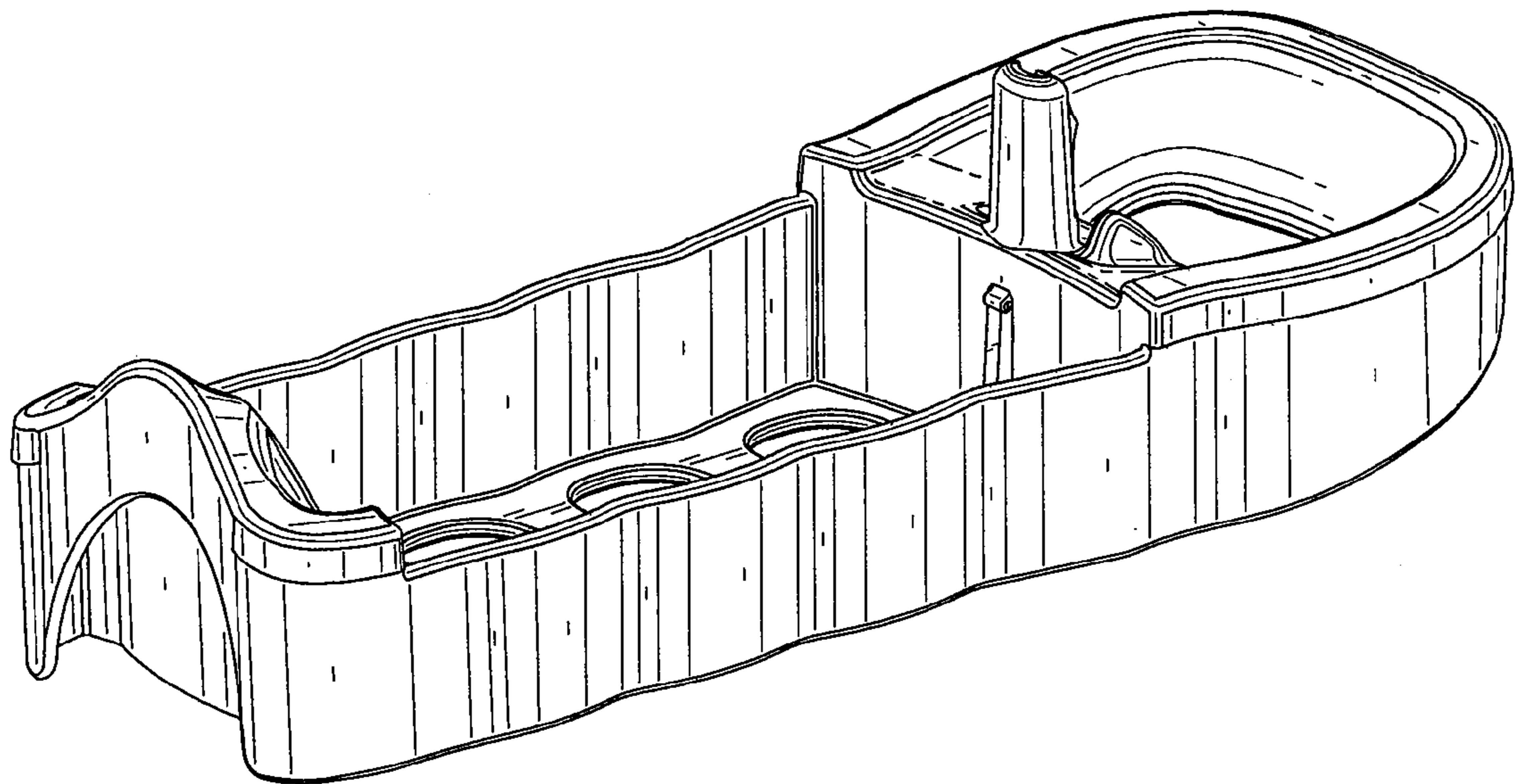

FIG. 1

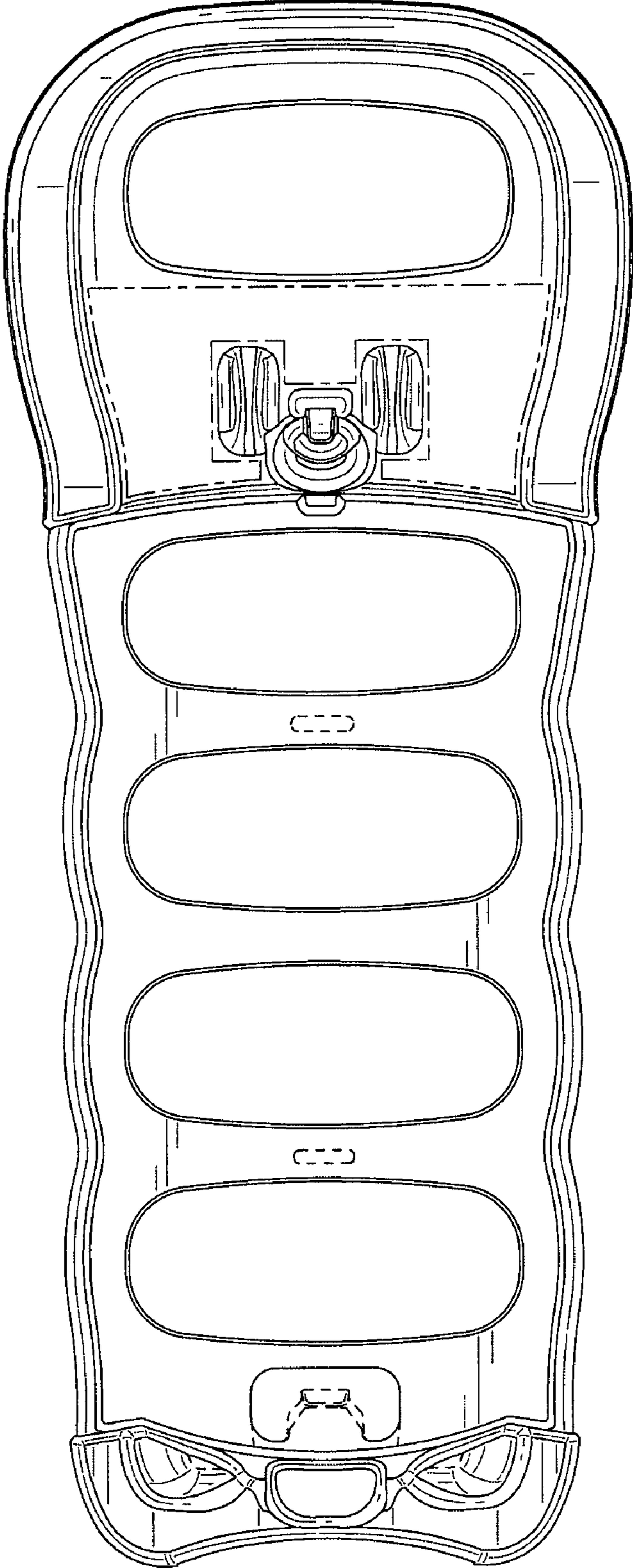

FIG. 2

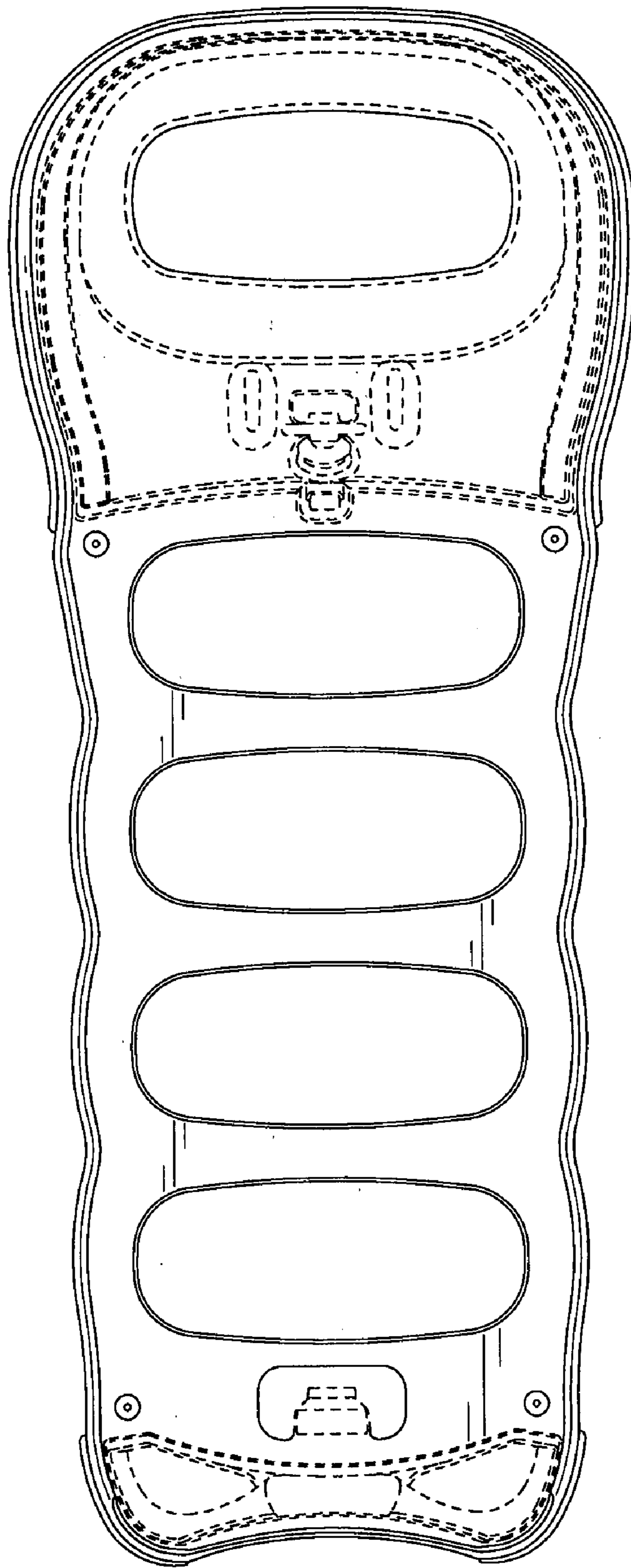

FIG. 3



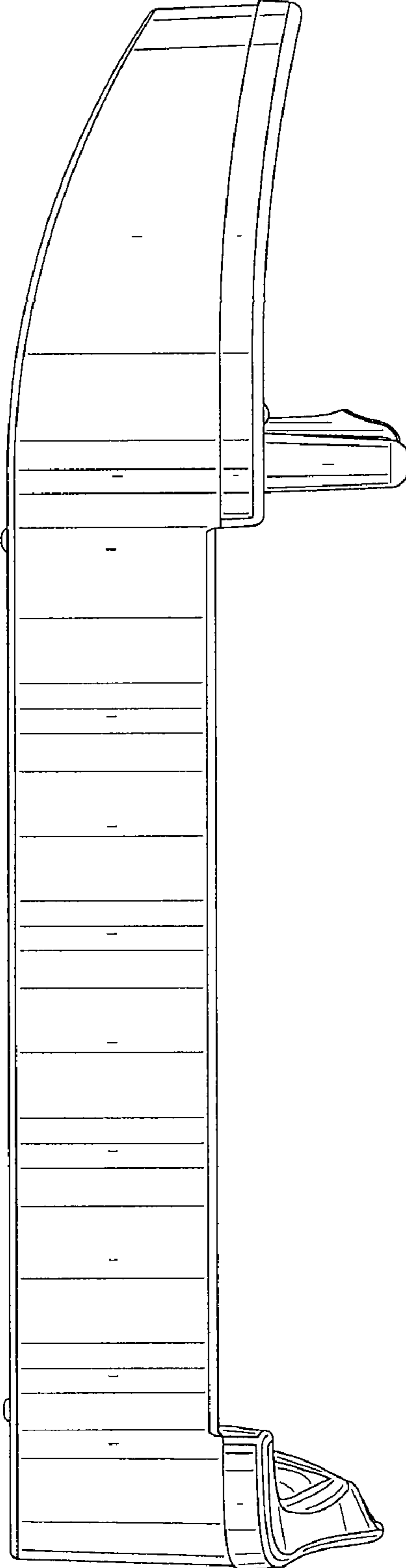

FIG. 4

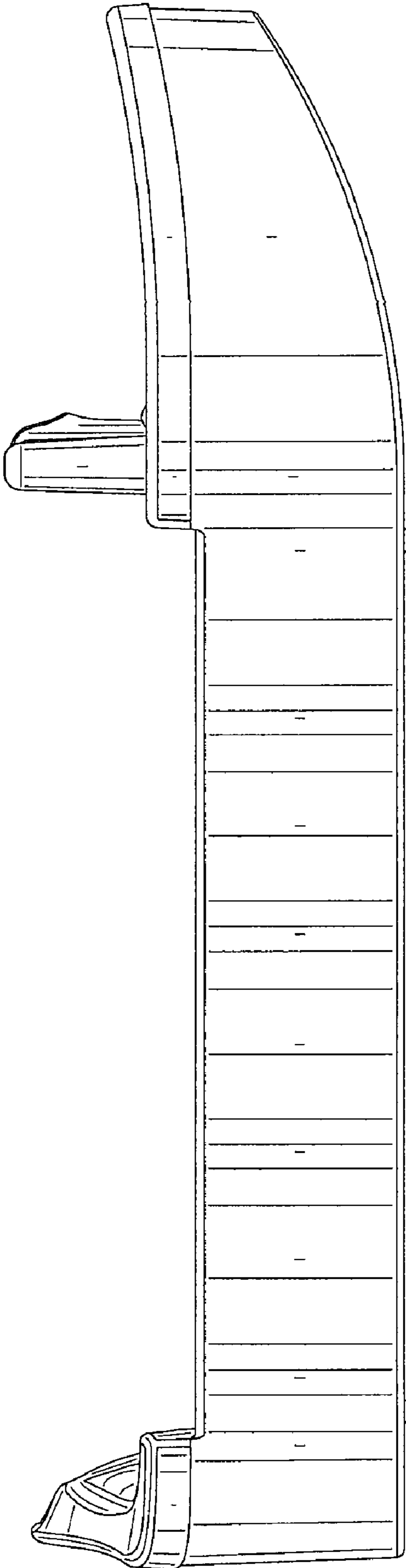

FIG. 5

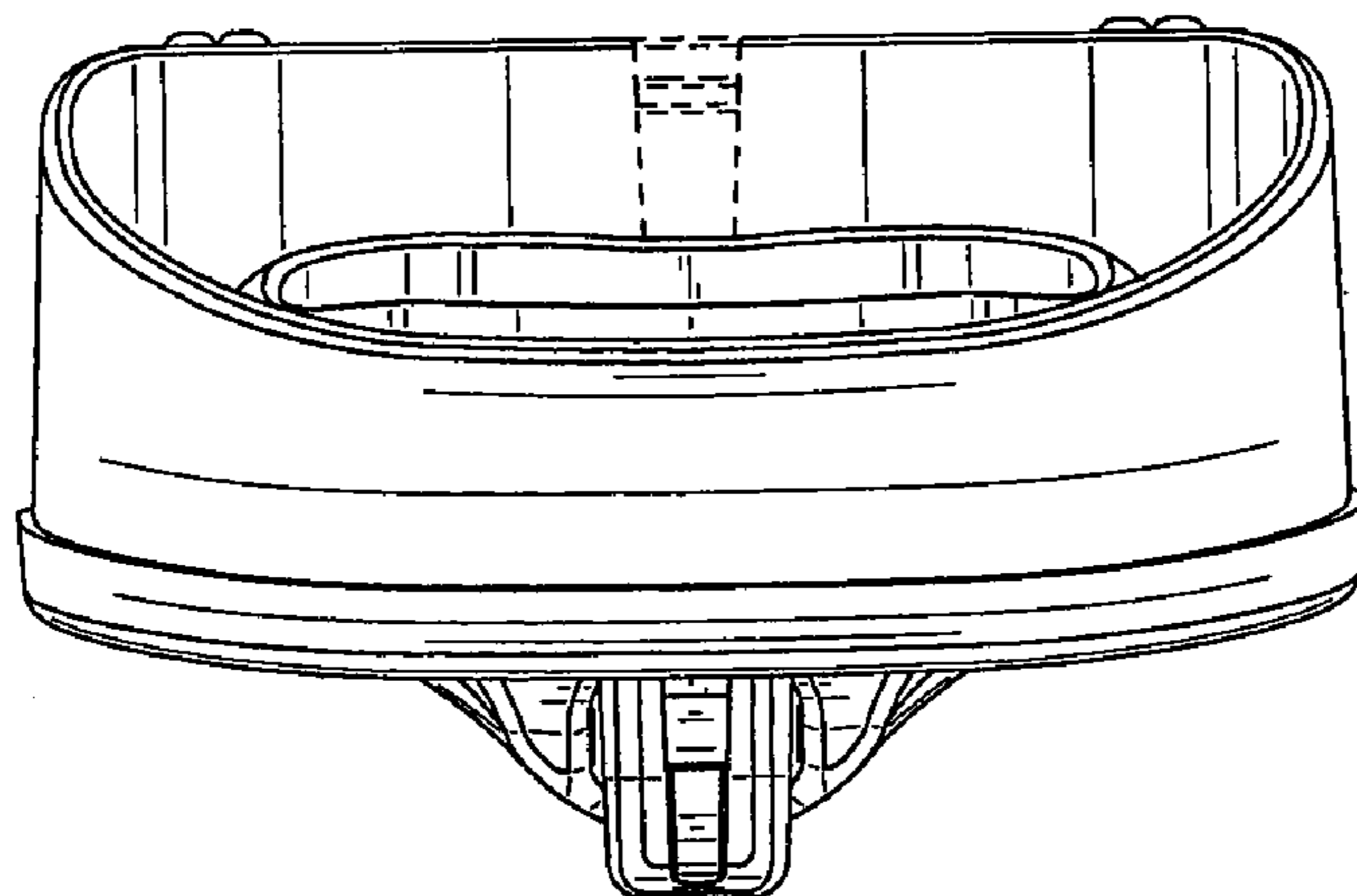

FIG. 6

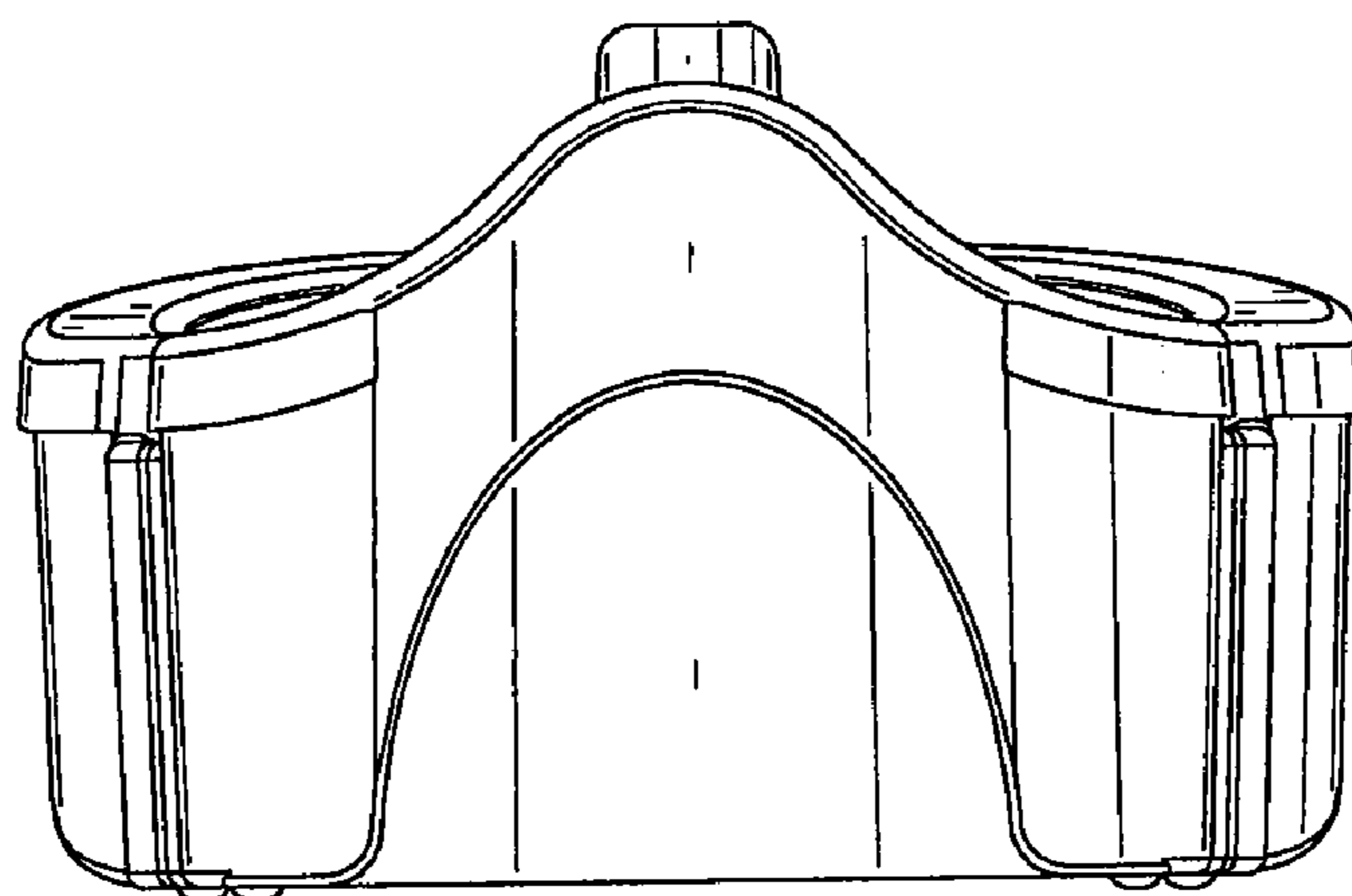

FIG. 7