



US00D633361S

(12) **United States Design Patent**
Chang

(10) **Patent No.:** **US D633,361 S**
(45) **Date of Patent:** **** Mar. 1, 2011**

(54) **DUAL-USE CIRCULAR KNIFE**

(76) Inventor: **Pi-Chao Chang**, Taipei (TW)

(**) Term: **14 Years**

(21) Appl. No.: **29/311,541**

(22) Filed: **Apr. 17, 2009**

(51) **LOC (9) Cl.** **08-03**

(52) **U.S. Cl.** **D8/98**

(58) **Field of Classification Search** D8/98,
D8/99; 30/276, 292, 294, 319
See application file for complete search history.

(56) **References Cited**

U.S. PATENT DOCUMENTS

D288,522	S *	3/1987	Salem	D8/98
5,144,749	A *	9/1992	Chen	30/319
D537,699	S *	3/2007	Fraga	D8/99
7,204,023	B2 *	4/2007	Chang	30/319
D557,583	S *	12/2007	Lewis et al.	D8/95
D582,239	S *	12/2008	Eby et al.	D8/98
D602,324	S *	10/2009	Hancock et al.	D8/98
2008/0010839	A1 *	1/2008	Eby et al.	30/319

OTHER PUBLICATIONS

Craft Cutter CC-10: Downloaded Feb. 26, 2020 at <http://www.pdacardandcraft.co.uk/merchant.ihtml?step=4&lastcatid=150&pid=717>.*

Reliable Hand Held Cloth Cutter Machine. Snagged Feb. 26, 2010 at [http://images.google.com/imgres?imgurl=http://salestores.com/stores/images/images_...*](http://images.google.com/imgres?imgurl=http://salestores.com/stores/images/images_...)

* cited by examiner

Primary Examiner—Philip S Hyder

Assistant Examiner—Roselynn Cody

(74) *Attorney, Agent, or Firm*—Banger Shia

(57) **CLAIM**

The ornamental design for a dual-use circular knife, as shown and described.

DESCRIPTION

FIG. 1 is a perspective view of a dual-use circular knife;

FIG. 2 is a front view thereof;

FIG. 3 is a back view thereof;

FIG. 4 is a left view thereof;

FIG. 5 is a right view thereof;

FIG. 6 is a top view thereof; and,

FIG. 7 is a bottom view thereof.

1 Claim, 7 Drawing Sheets

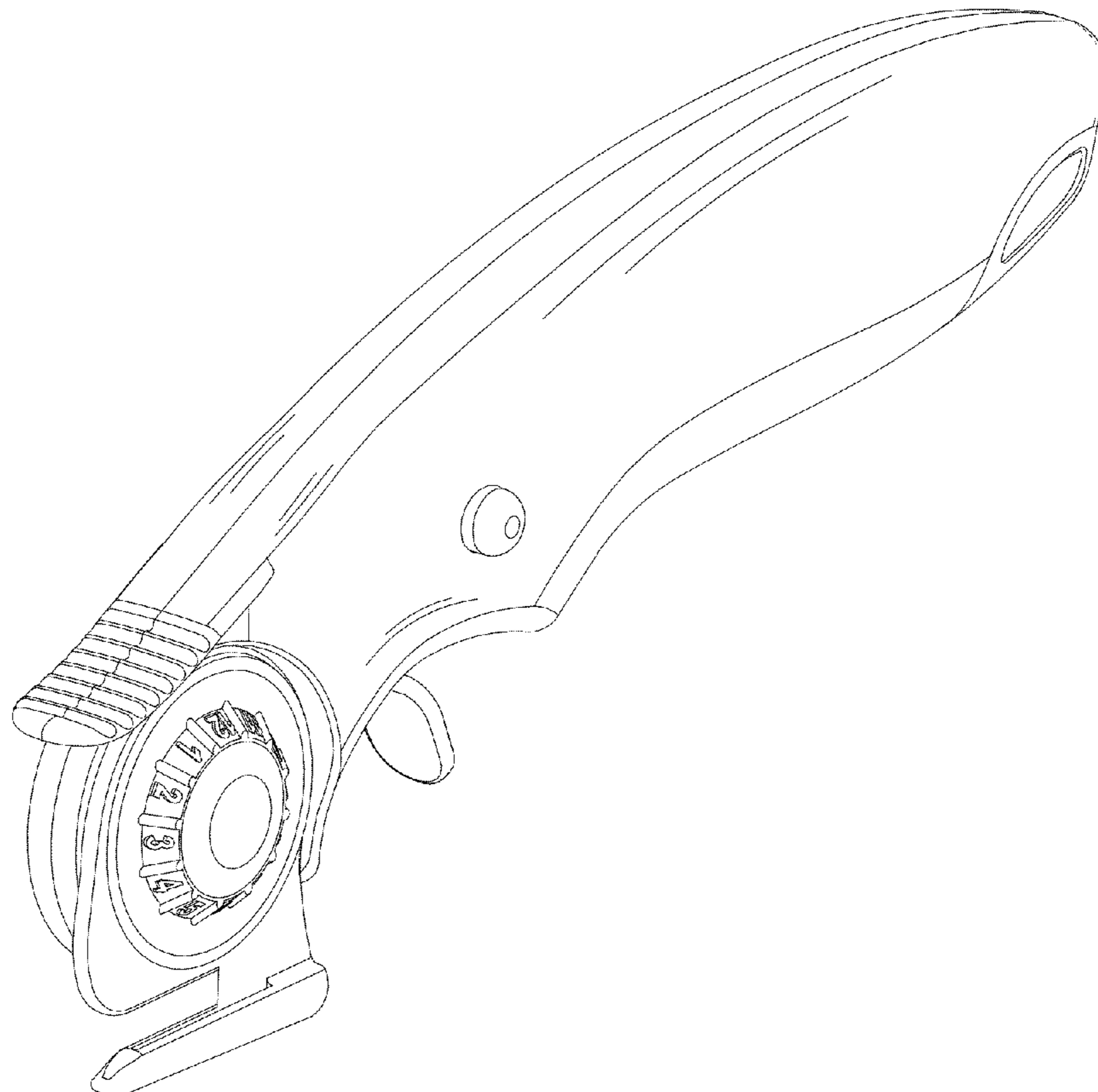

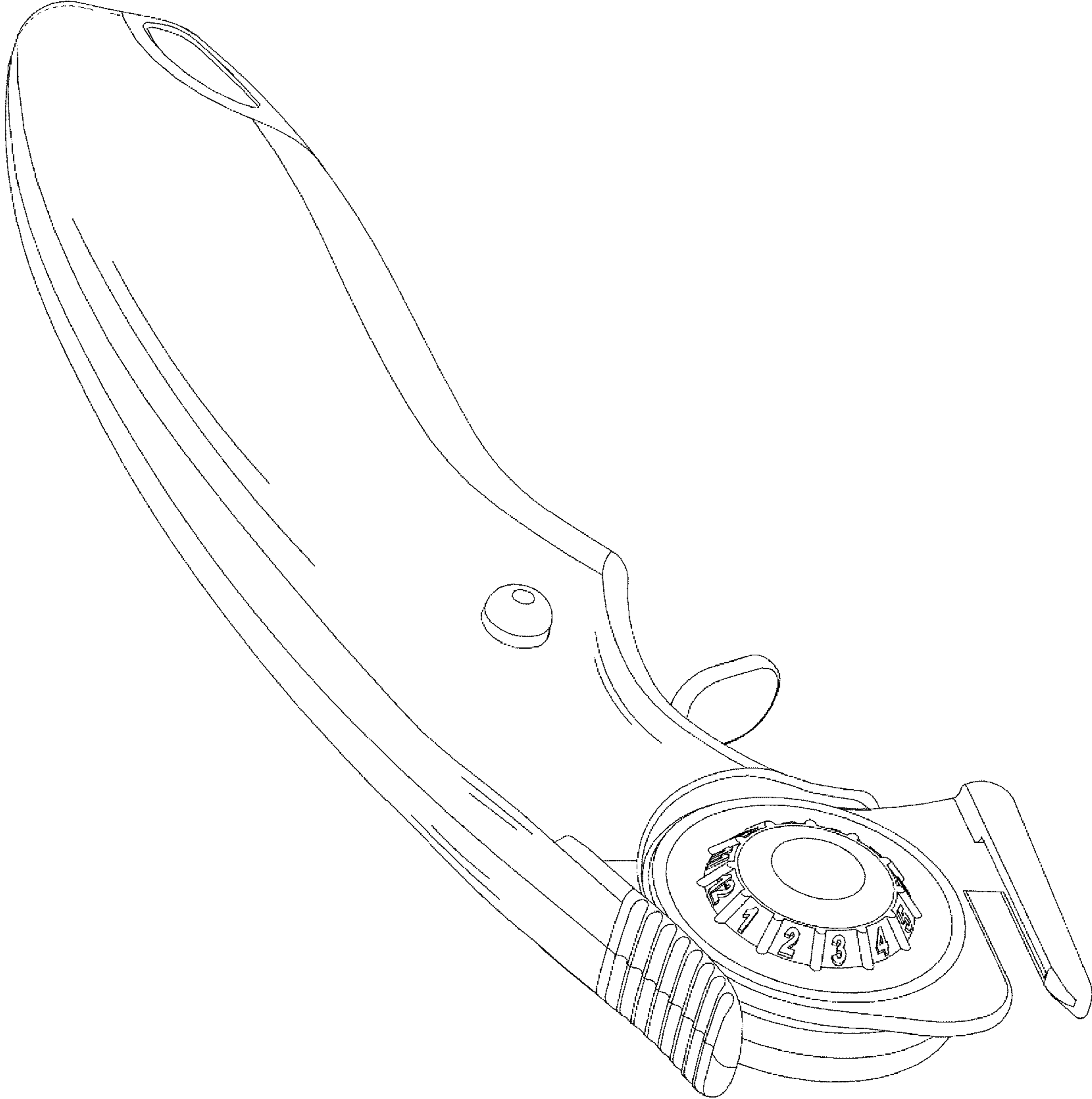

FIG. 1

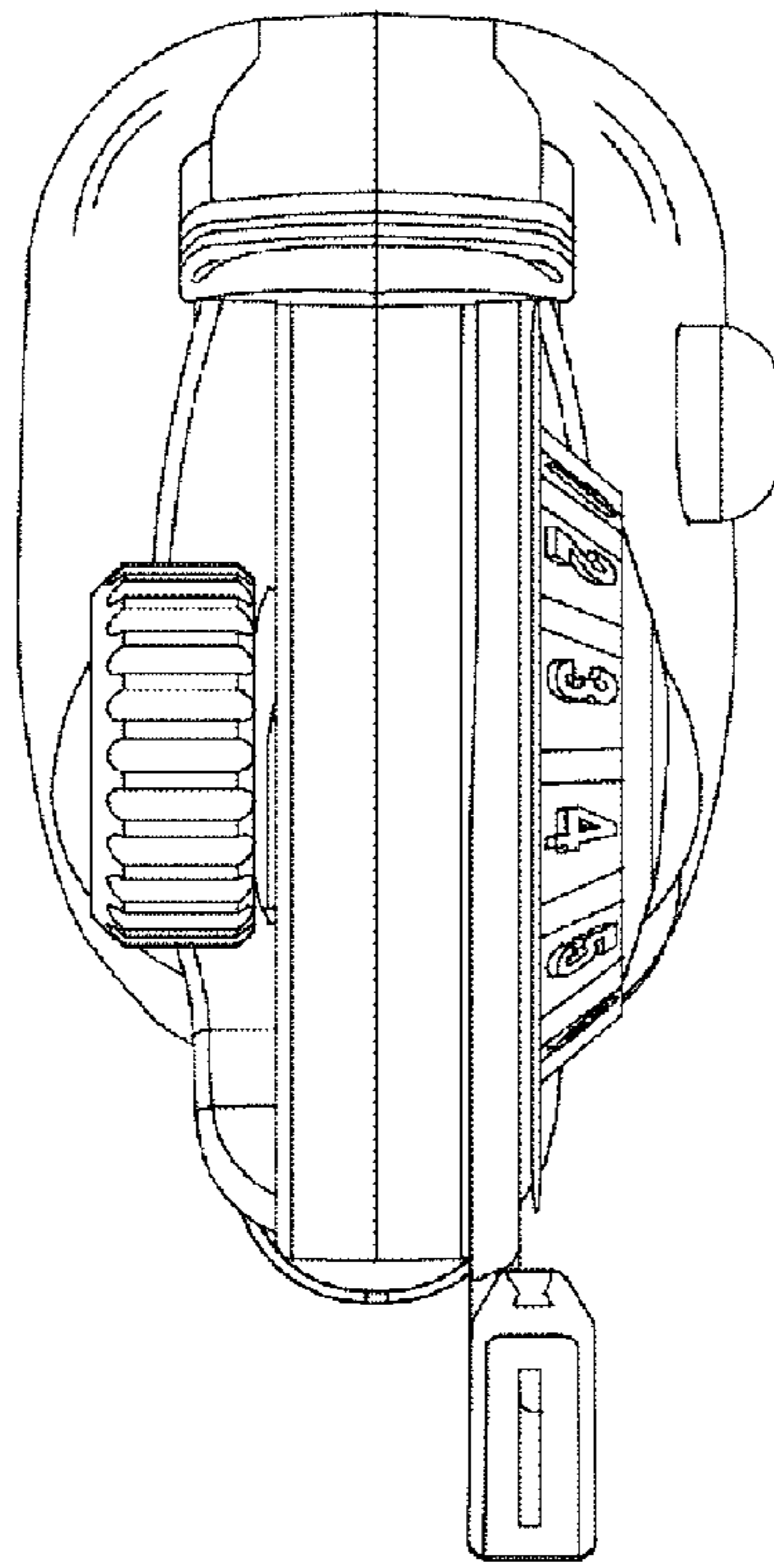

FIG. 2

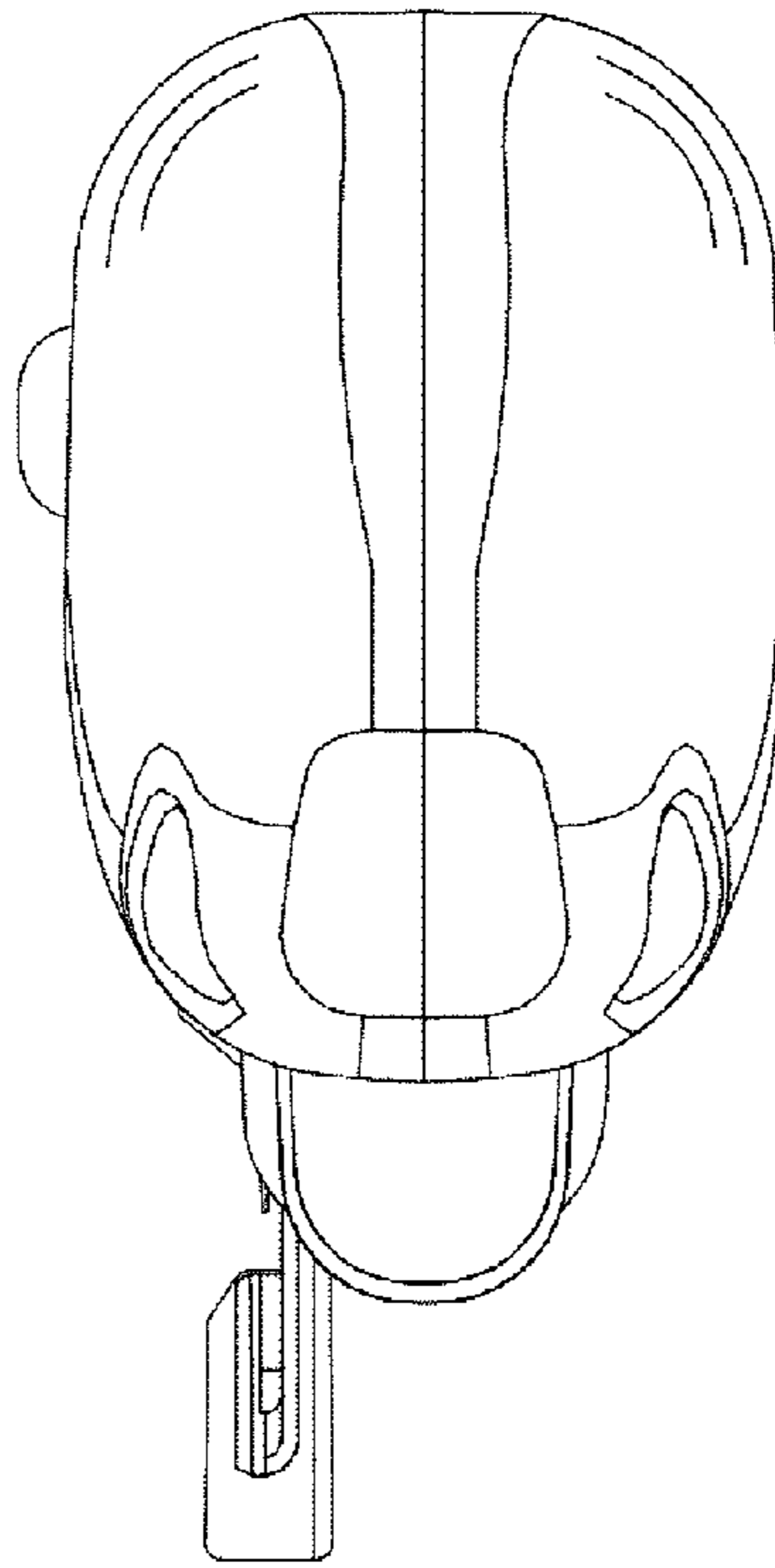

FIG. 3

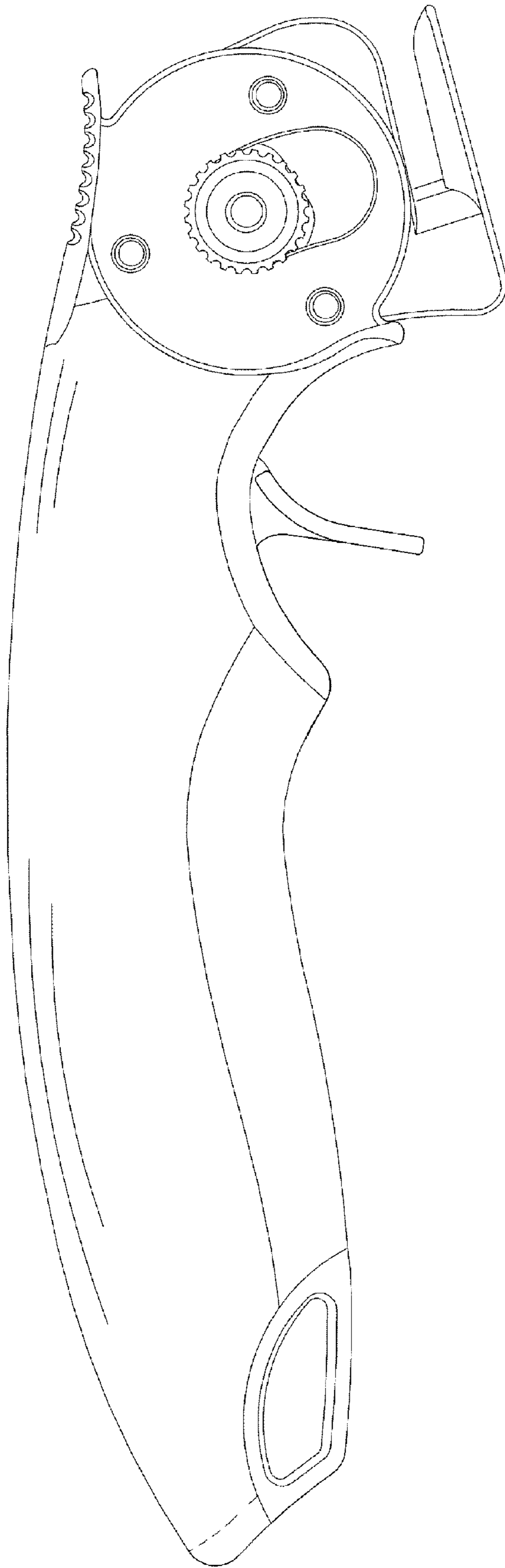

FIG. 4

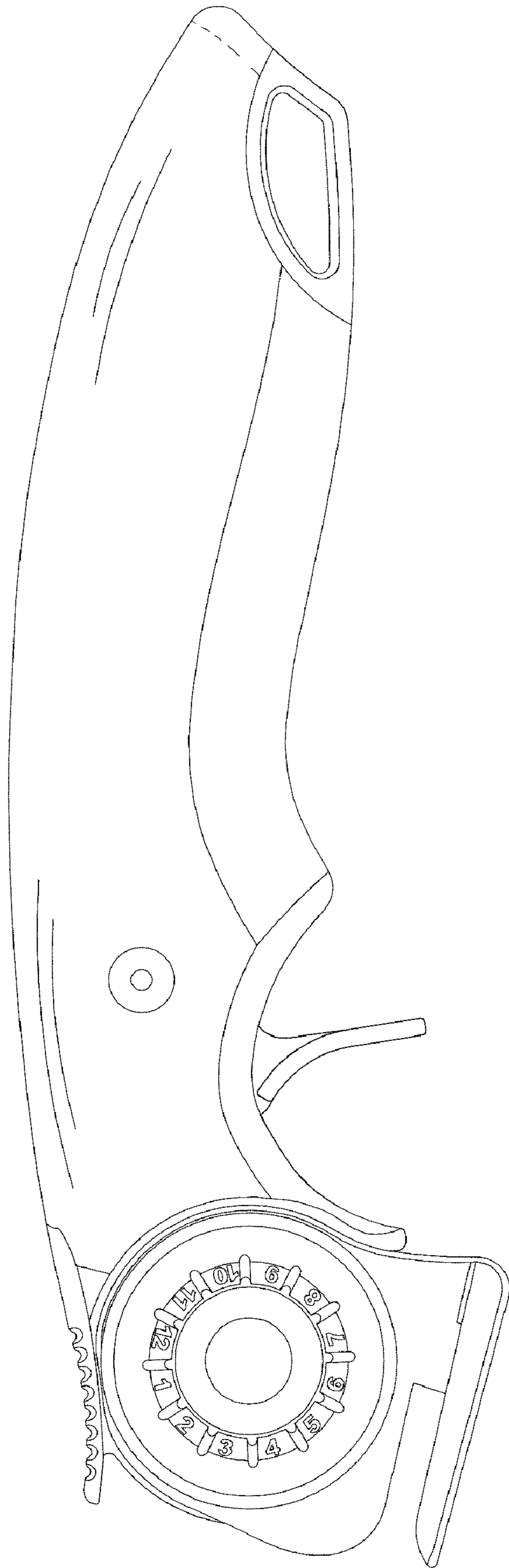

FIG. 5

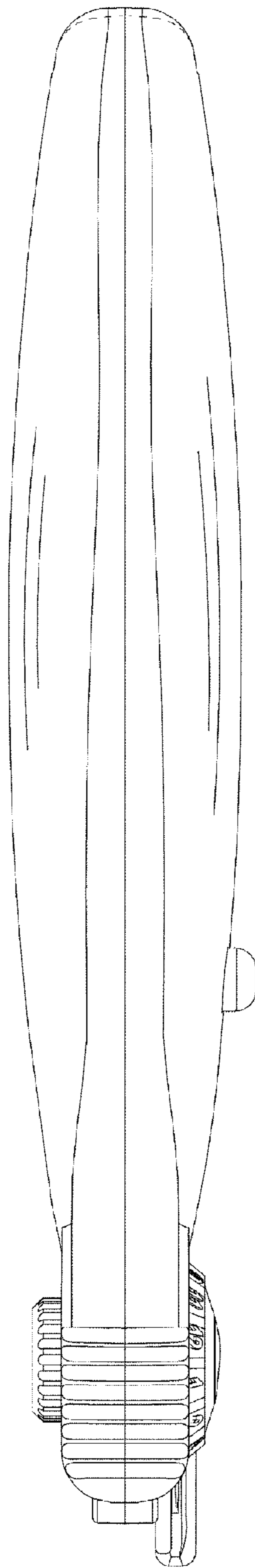

FIG. 6

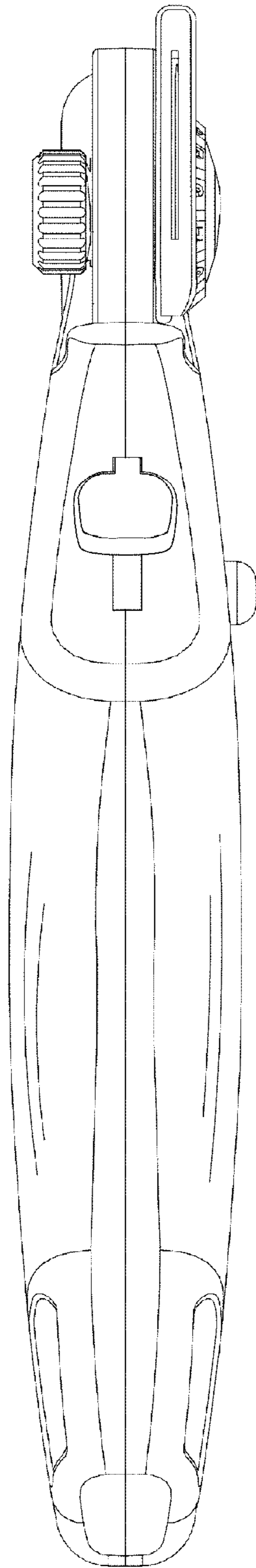

FIG. 7