



US00D633336S

(12) **United States Design Patent**
Sadtler

(10) **Patent No.:** **US D633,336 S**
(45) **Date of Patent:** **** Mar. 1, 2011**

(54) **STEAM OVEN**

(75) Inventor: **Graham Sadtler**, Huntington Beach, CA (US)

(73) Assignee: **BSH Home Appliances Corporation**, Huntington Beach, CA (US)

(**) Term: **14 Years**

(21) Appl. No.: **29/366,174**

(22) Filed: **Jul. 21, 2010**

(51) **LOC (9) Cl.** **07-02**

(52) **U.S. Cl.** **D7/405**

(58) **Field of Classification Search** D7/339-441;
126/19 R, 21 A, 21 R, 39 B, 39 C, 239 R,
126/273 A, 273 R; 219/391-394, 756-758;
99/DIG. 14

See application file for complete search history.

(56) **References Cited**

U.S. PATENT DOCUMENTS

D175,184 S	*	7/1955	Lachey et al.	D7/405
D379,734 S	*	6/1997	Baldwin	D7/405
D399,390 S	*	10/1998	Baldwin	D7/348
D423,287 S	*	4/2000	Marchand	D7/405
D429,953 S	*	8/2000	Orzel et al.	D7/405
D512,873 S	*	12/2005	Grutzke et al.	D7/405
D516,379 S	*	3/2006	Grutzke et al.	D7/405
D516,862 S	*	3/2006	Grutzke et al.	D7/405
D521,805 S	*	5/2006	Hessen et al.	D7/405
D566,465 S	*	4/2008	Crookshanks	D7/405
D570,156 S	*	6/2008	Laundroche	D7/405
D586,618 S	*	2/2009	Cutino	D7/405
D592,009 S	*	5/2009	Crookshanks	D7/405

* cited by examiner

Primary Examiner—T. Chase Nelson

Assistant Examiner—Mark Cavanna

(74) *Attorney, Agent, or Firm*—James E. Howard; Andre Pallapies

(57) **CLAIM**

The ornamental design for steam oven, as shown and described.

DESCRIPTION

FIG. 1 is a perspective view from the front, right side of a steam oven according to a first embodiment showing my new design;

FIG. 2 is a front view thereof;

FIG. 3 is a top view thereof;

FIG. 4 is a bottom view thereof;

FIG. 5 is a right side view thereof;

FIG. 6 is a left side view thereof;

FIG. 7 is a perspective view from the front, right side of a steam oven according to a second embodiment showing my new ornamental design;

FIG. 8 is a front view thereof;

FIG. 9 is a top view thereof;

FIG. 10 is a bottom view thereof;

FIG. 11 is a right side view thereof; and,

FIG. 12 is a left side view thereof.

The broken lines represent environment or structure of the steam oven, and do not form any part of the claimed design.

The rear views of the two embodiments are unornamented and unclaimed and therefore are not provided.

1 Claim, 8 Drawing Sheets

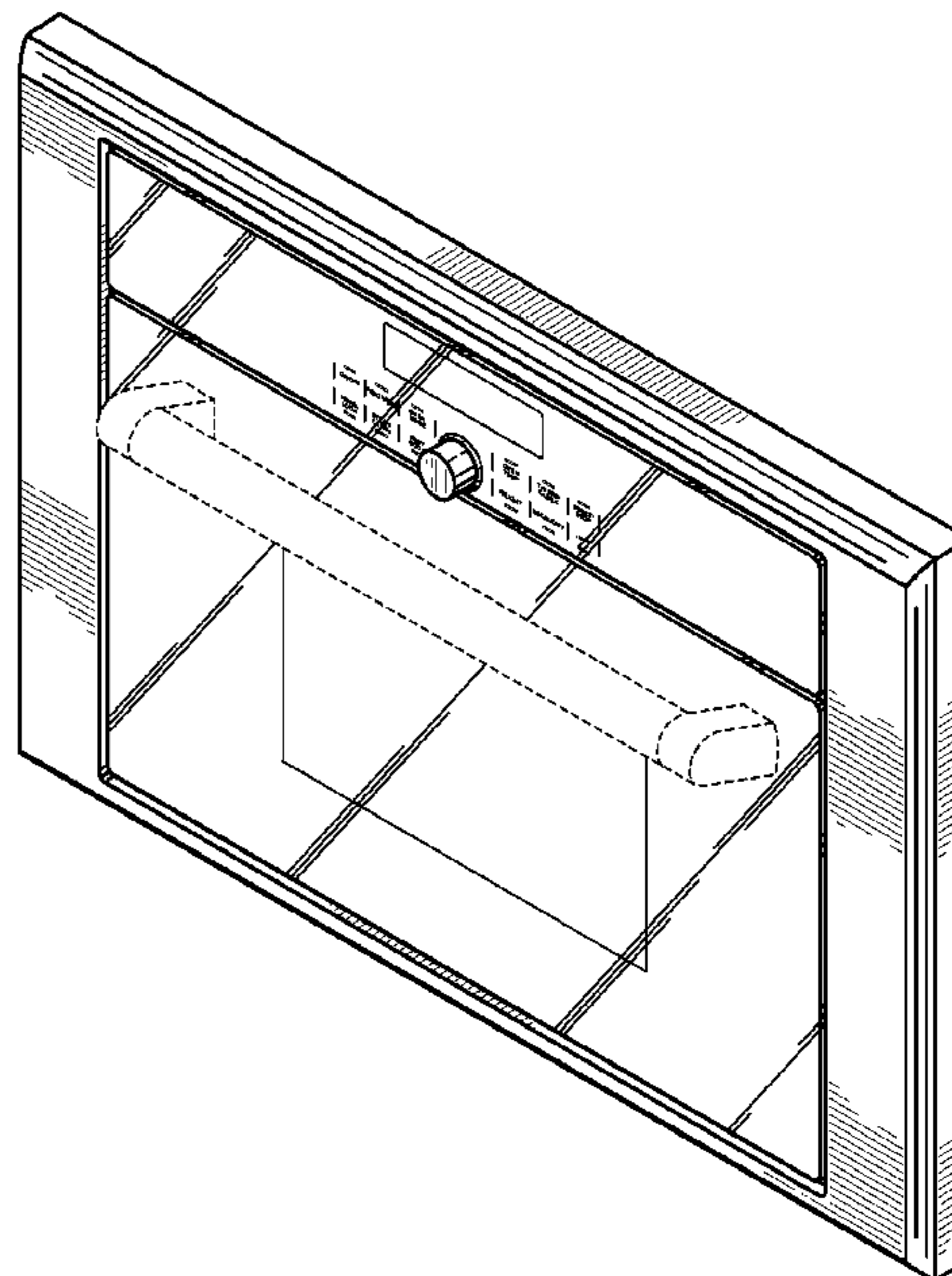
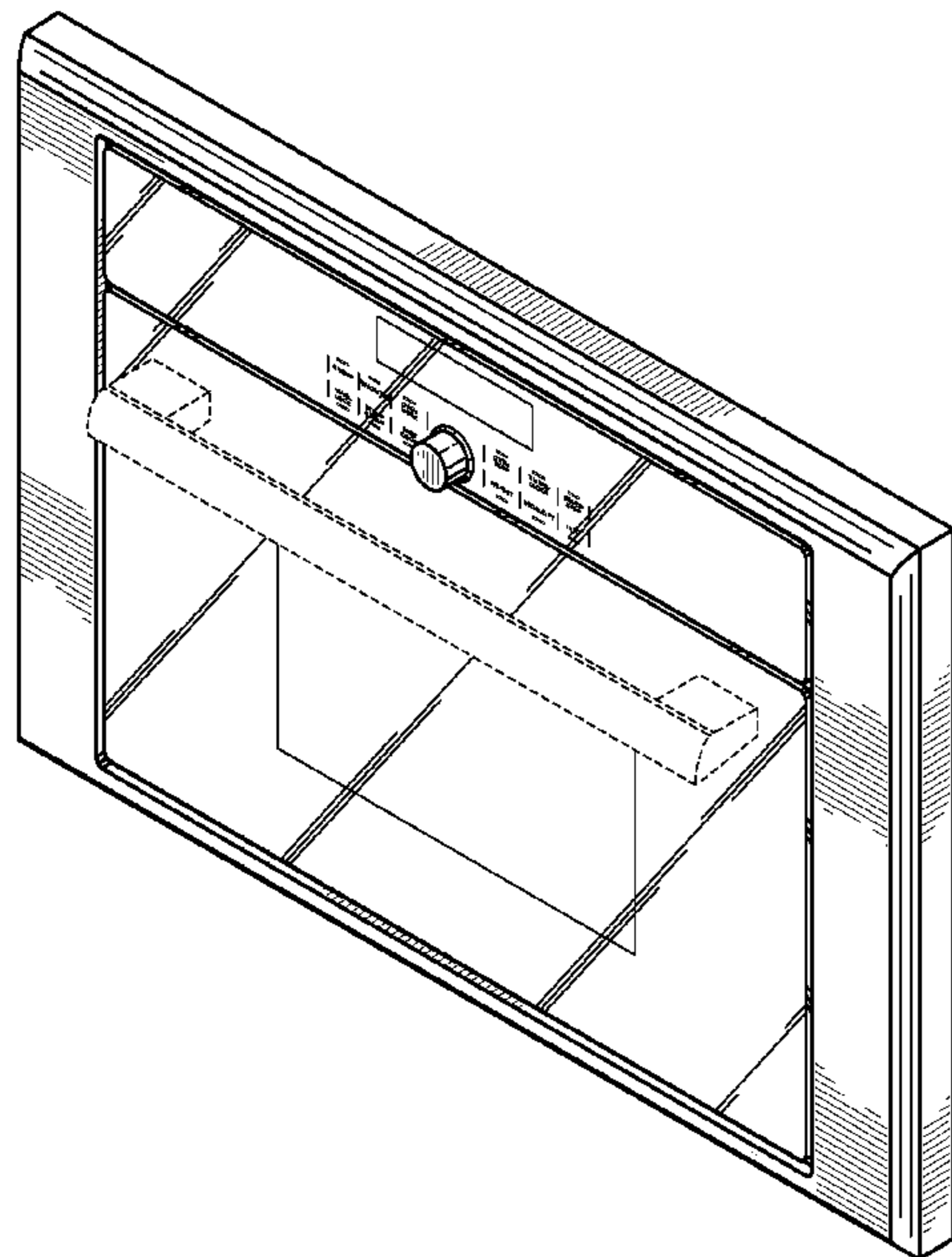
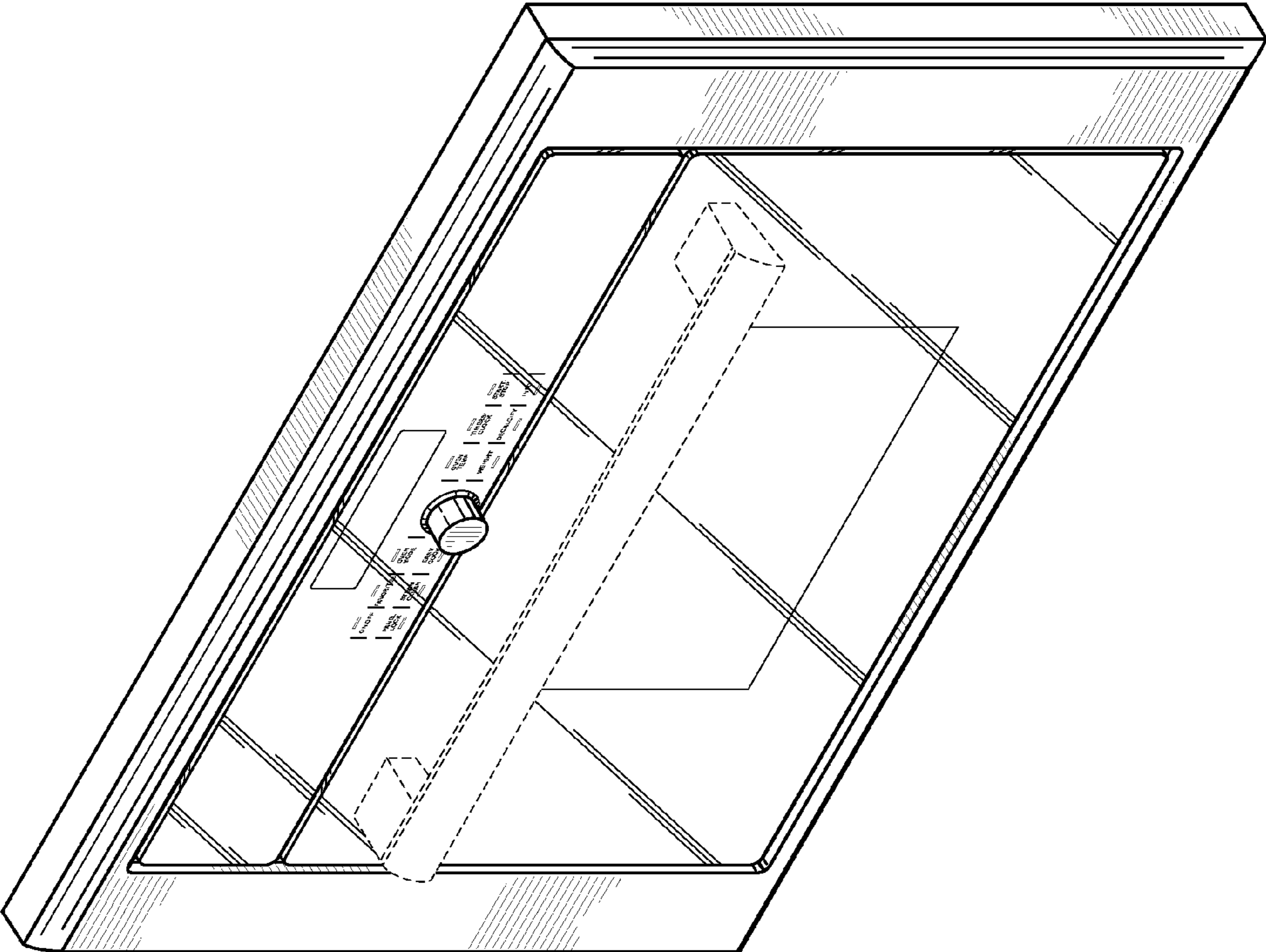

Fig. 1



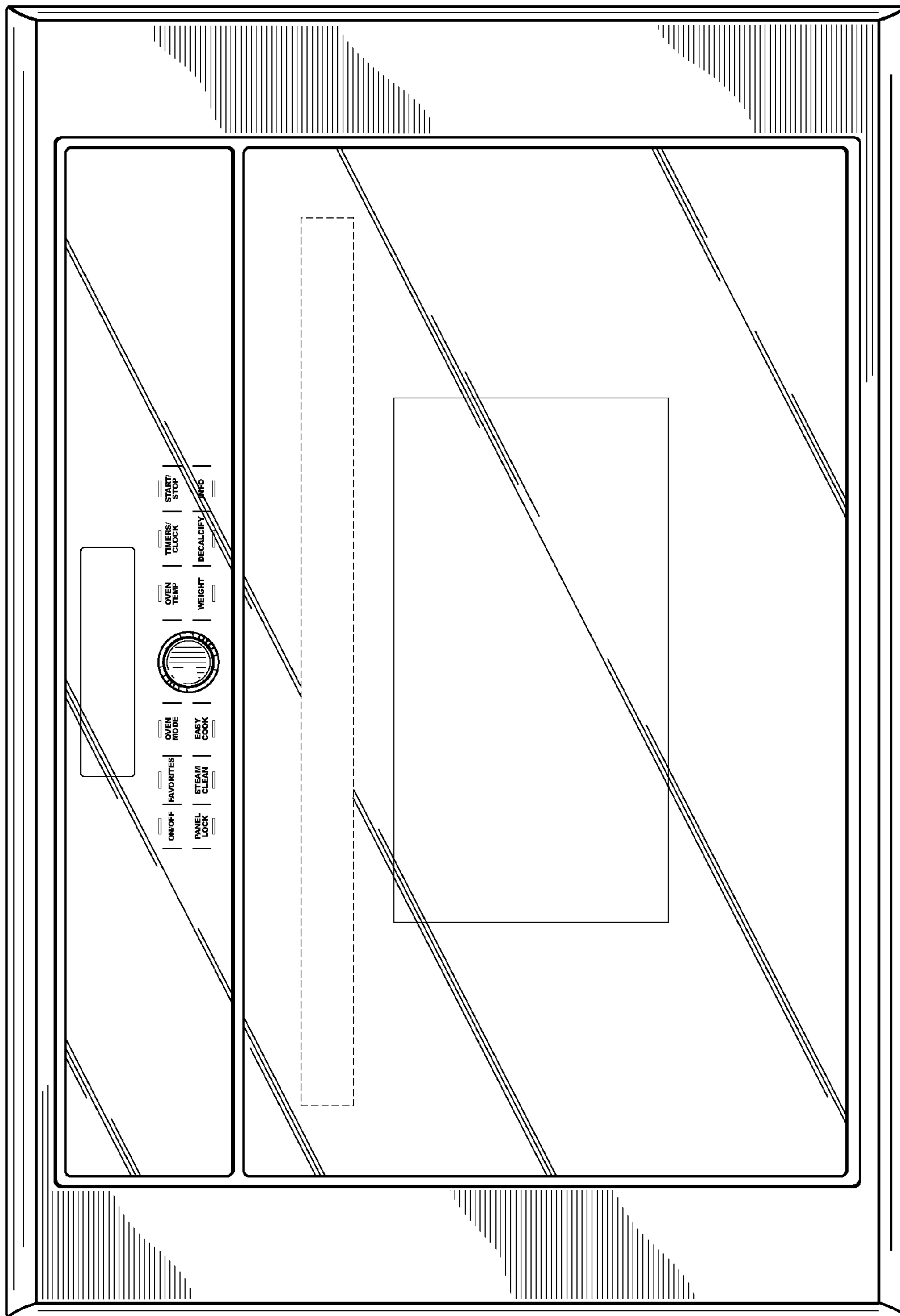

Fig. 2

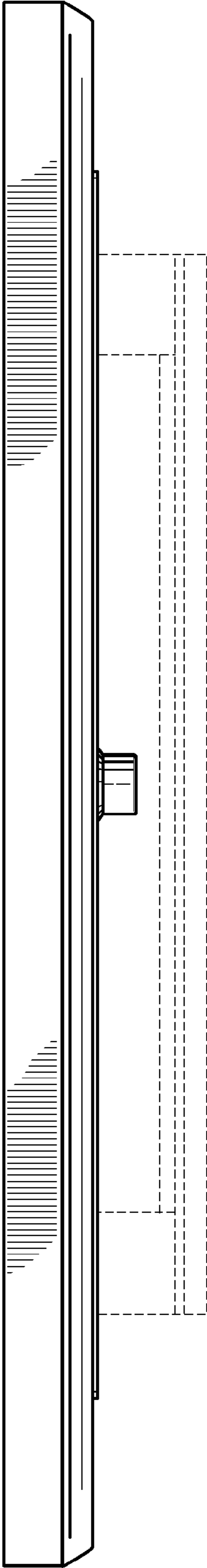

Fig. 3

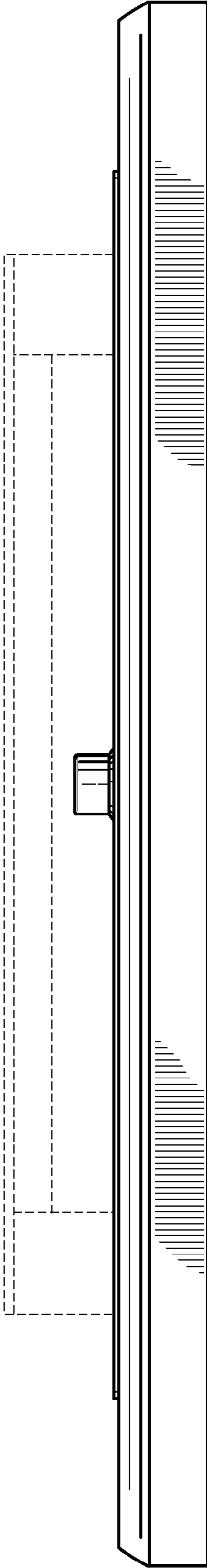

Fig. 4

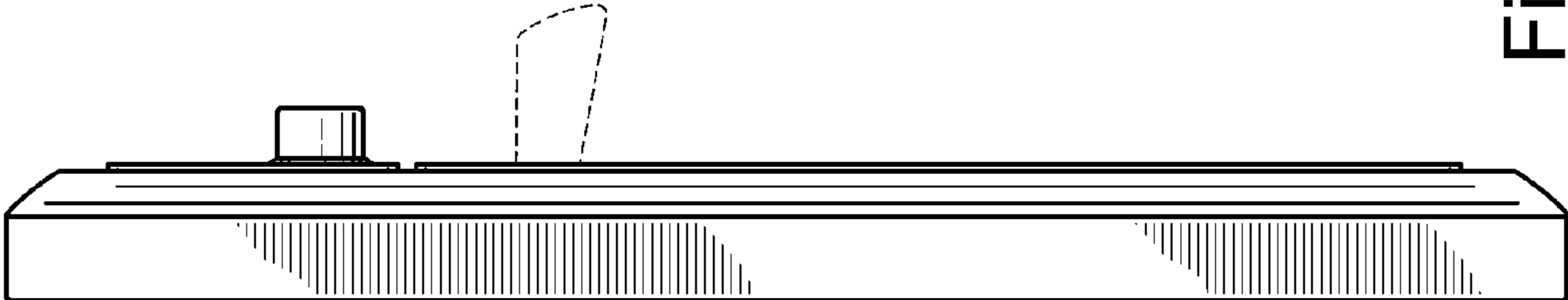

Fig. 6

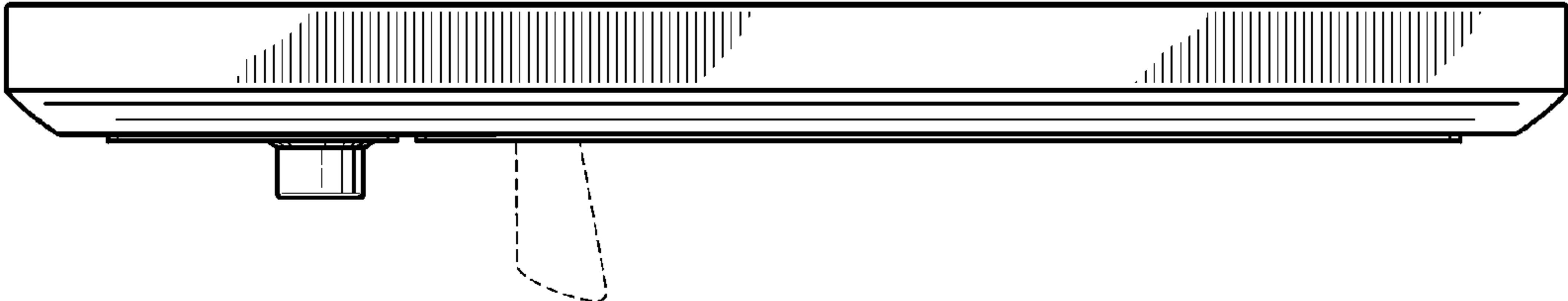

Fig. 5

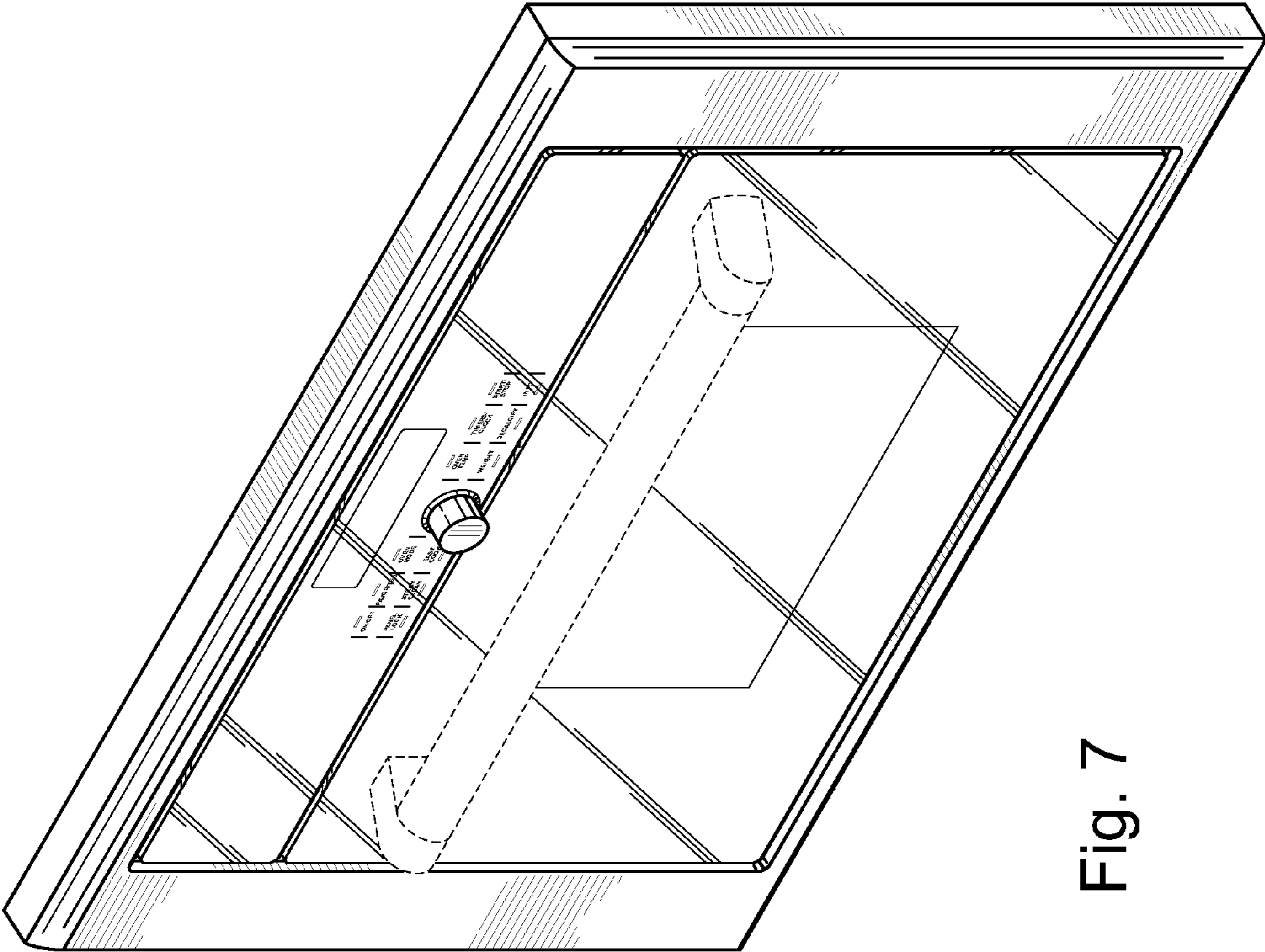

Fig. 7

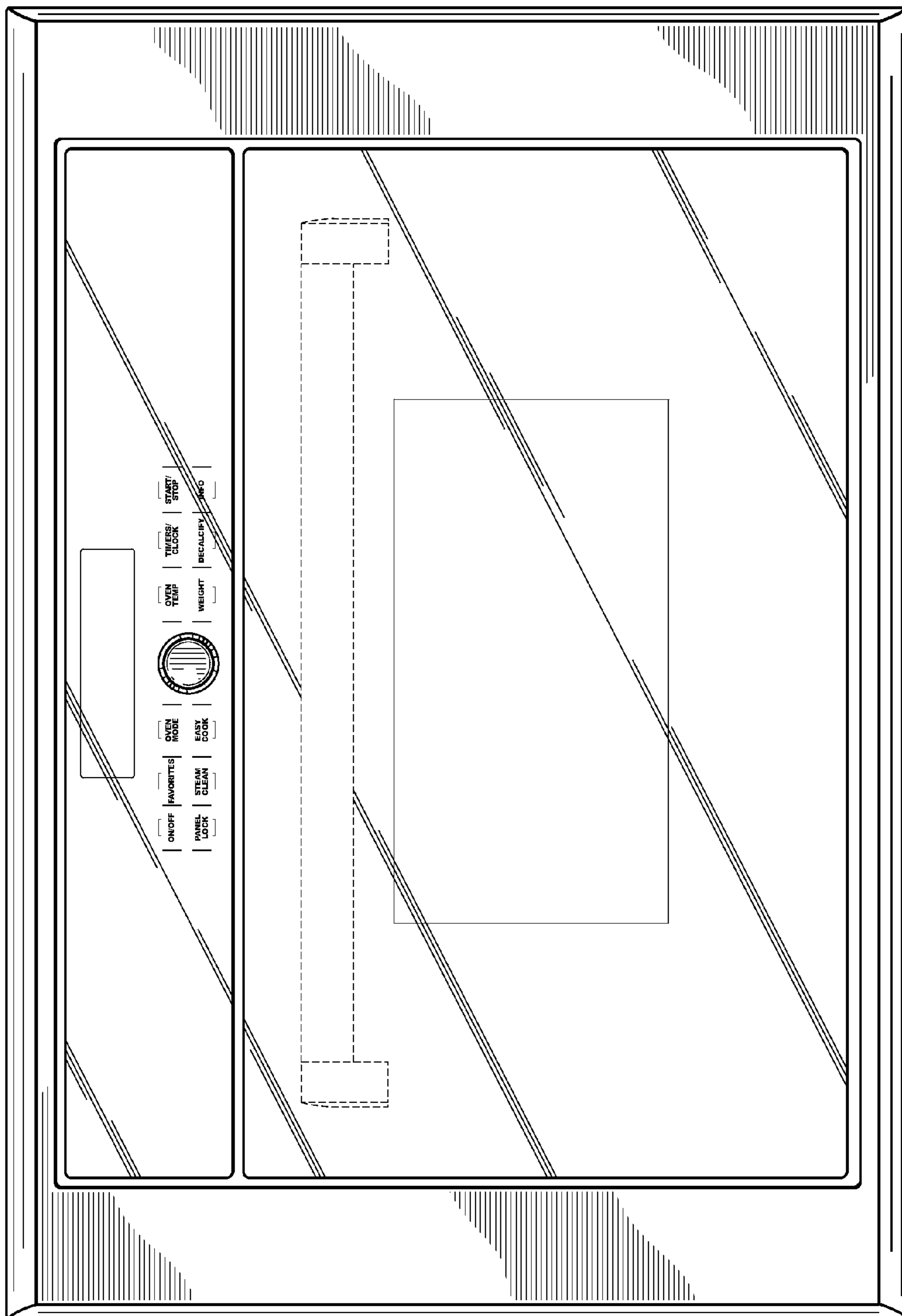

Fig. 8

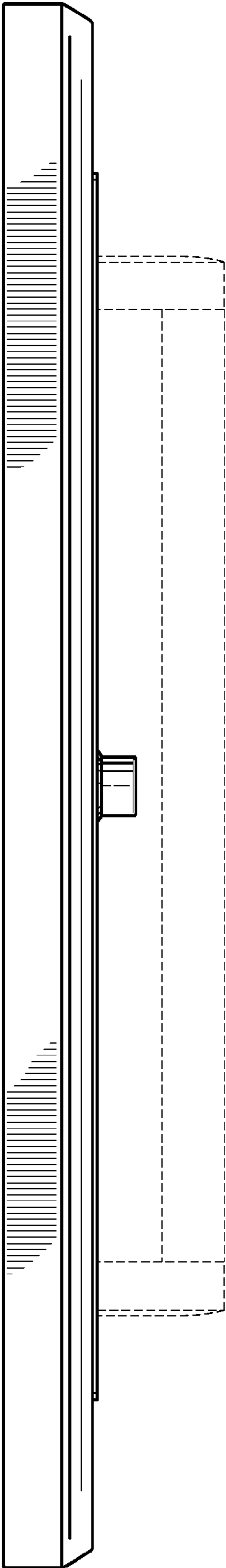

Fig. 9

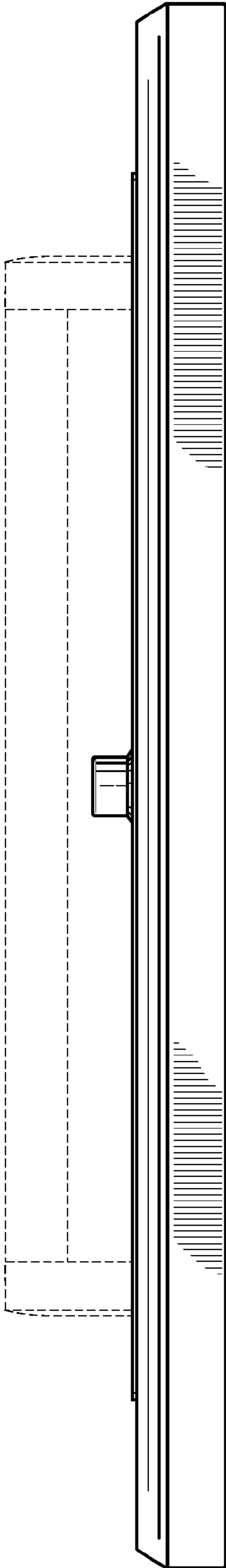

Fig. 10

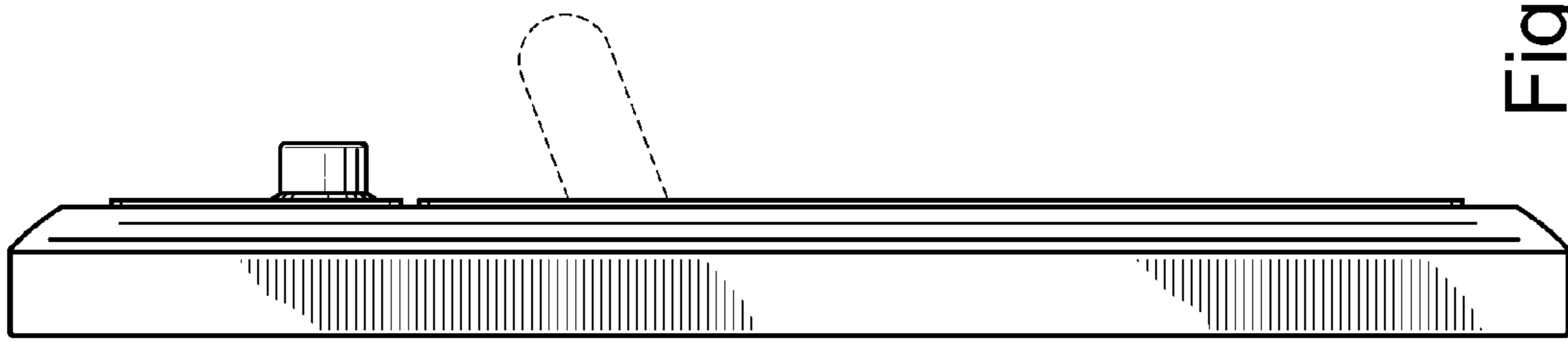

Fig. 12

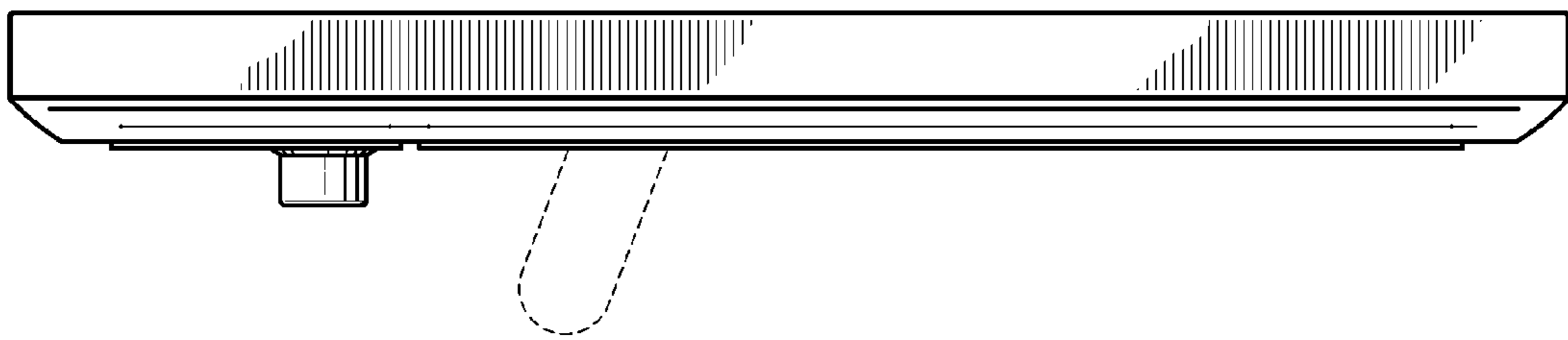

Fig. 11