



US00D633325S

(12) **United States Design Patent**
McArdle

(10) **Patent No.:** **US D633,325 S**
(45) **Date of Patent:** **** Mar. 1, 2011**

(54) **BEVERAGE PITCHER**

(75) Inventor: **Christopher J. McArdle**, Rancho Cucamonga, CA (US)

(73) Assignee: **Prodyne Enterprises**, Rancho Cucamonga, CA (US)

(**) Term: **14 Years**

(21) Appl. No.: **29/368,581**

(22) Filed: **Aug. 25, 2010**

(51) **LOC (9) Cl.** **07-01**

(52) **U.S. Cl.** **D7/319; D7/317**

(58) **Field of Classification Search** D7/316-319,
D7/598; D23/213, 209; 222/465.1; 210/85;
220/475

See application file for complete search history.

(56) **References Cited**

U.S. PATENT DOCUMENTS

D335,239	S	*	5/1993	Crunden et al.	D7/317
D389,007	S	*	1/1998	Bouhuys	D7/319
D415,922	S	*	11/1999	Kawasaki et al.	D7/317
D419,027	S	*	1/2000	Haslem et al.	D7/319
D421,361	S	*	3/2000	Coulson et al.	D7/319
6,103,114	A	*	8/2000	Tanner et al.	210/232
D438,419	S	*	3/2001	Murphy	D7/319

D439,790	S	*	4/2001	Matsushita et al.	D7/319
D440,110	S	*	4/2001	Tanner		
D444,843	S	*	7/2001	Hilgers et al.	D23/207
D546,113	S	*	7/2007	Ruoff	D7/319
D576,250	S	*	9/2008	Born et al.	D23/209
D585,232	S	*	1/2009	Bodum	D7/319
D610,859	S	*	3/2010	Lundstrom	D7/319
D616,242	S	*	5/2010	Twycross	D7/321
D616,694	S	*	6/2010	Kulikov et al.	D7/319
D620,304	S	*	7/2010	Rajan et al.	D7/319

* cited by examiner

Primary Examiner—Marianne Pandozzi

(74) *Attorney, Agent, or Firm*—Cislo & Thomas, LLP

(57) **CLAIM**

The ornamental design for a beverage pitcher, as shown.

DESCRIPTION

FIG. 1 is a perspective view of the beverage pitcher.

FIG. 2 is a front view of the beverage pitcher.

FIG. 3 is a right side elevational view of the beverage pitcher.

FIG. 4 is a rear view of the beverage pitcher.

FIG. 5 is a left side elevational view of the beverage pitcher.

FIG. 6 is a top view of the beverage pitcher; and,

FIG. 7 is a bottom view of the beverage pitcher.

1 Claim, 4 Drawing Sheets

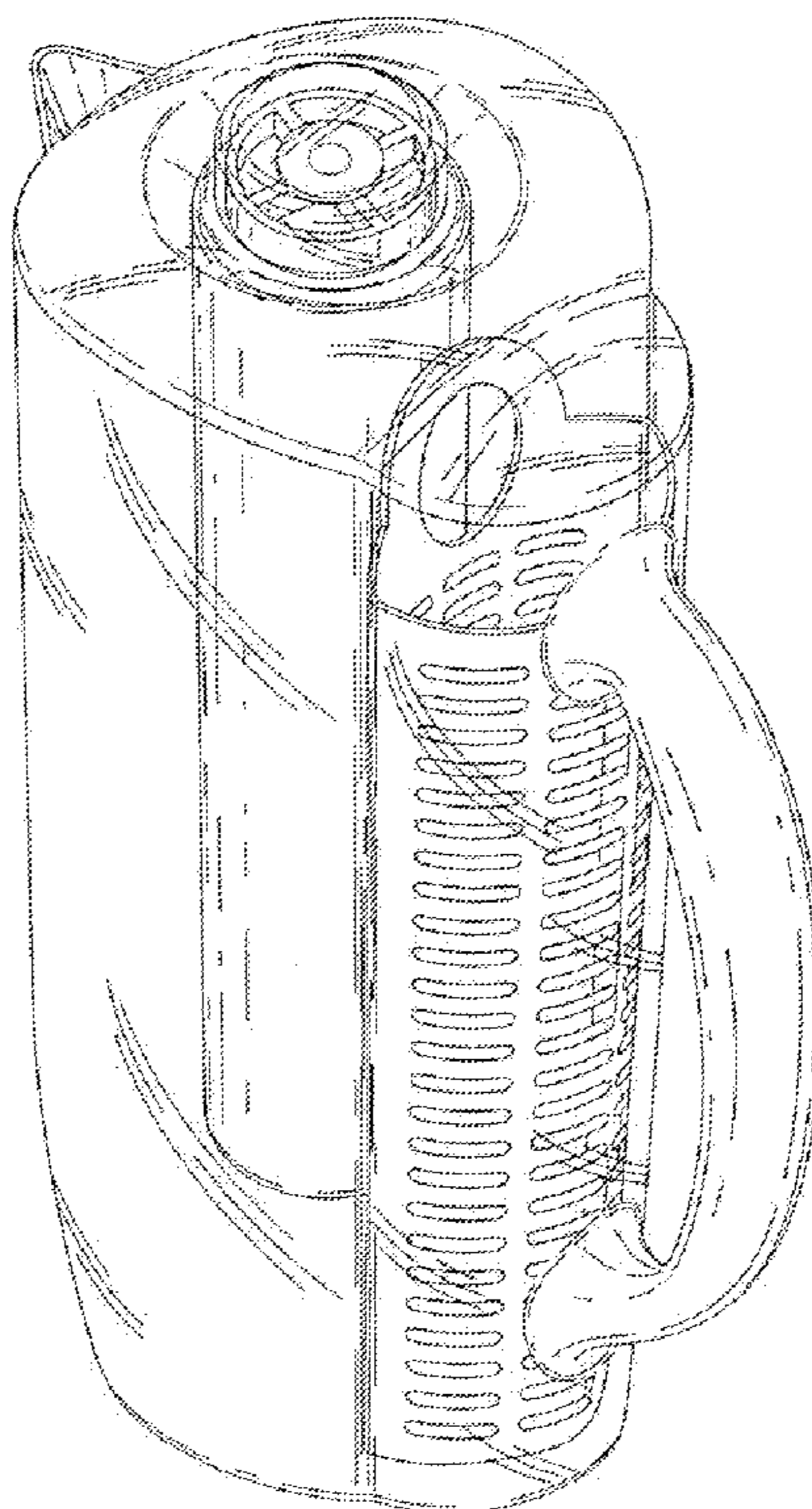

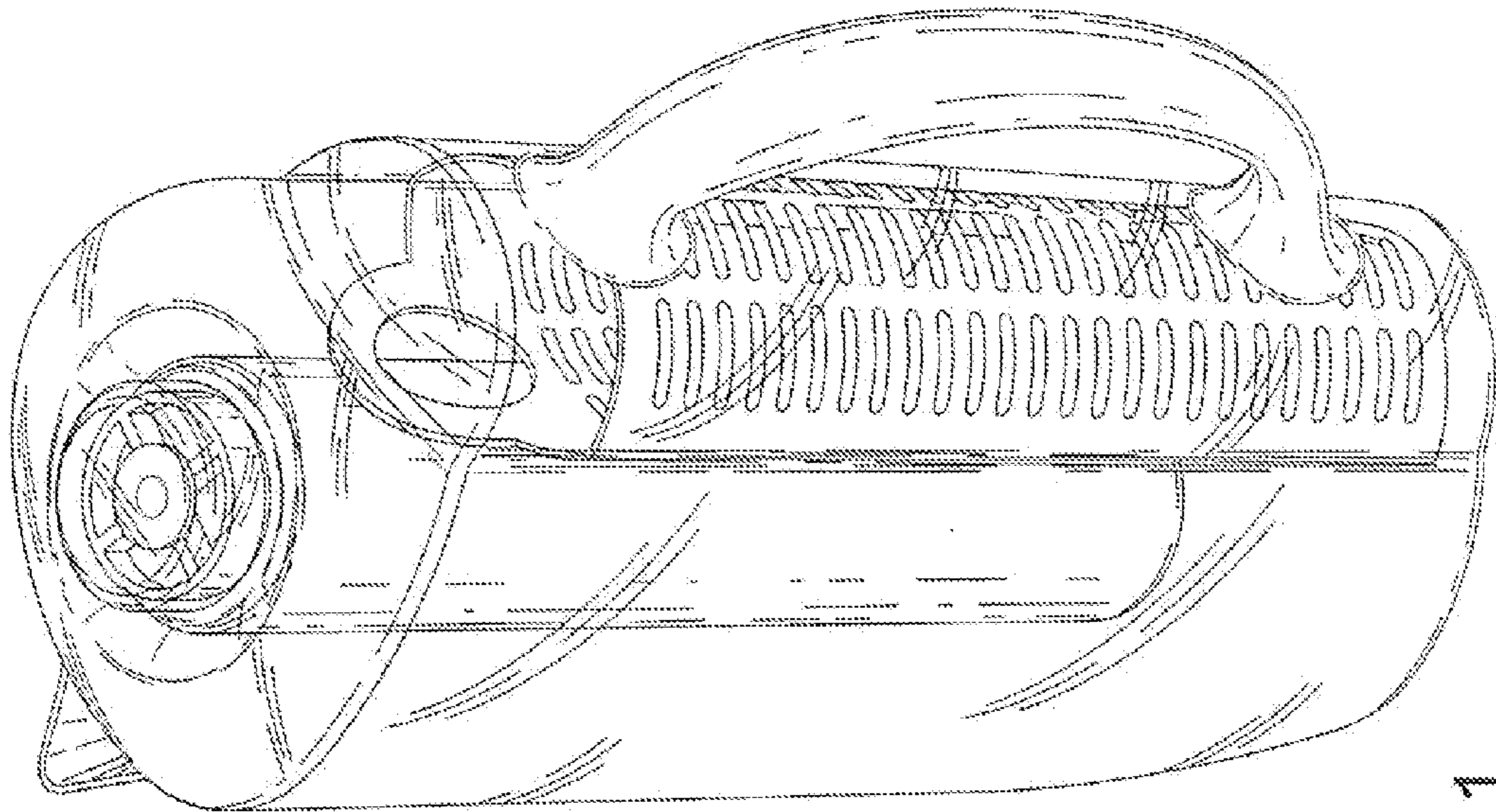

Fig. 1

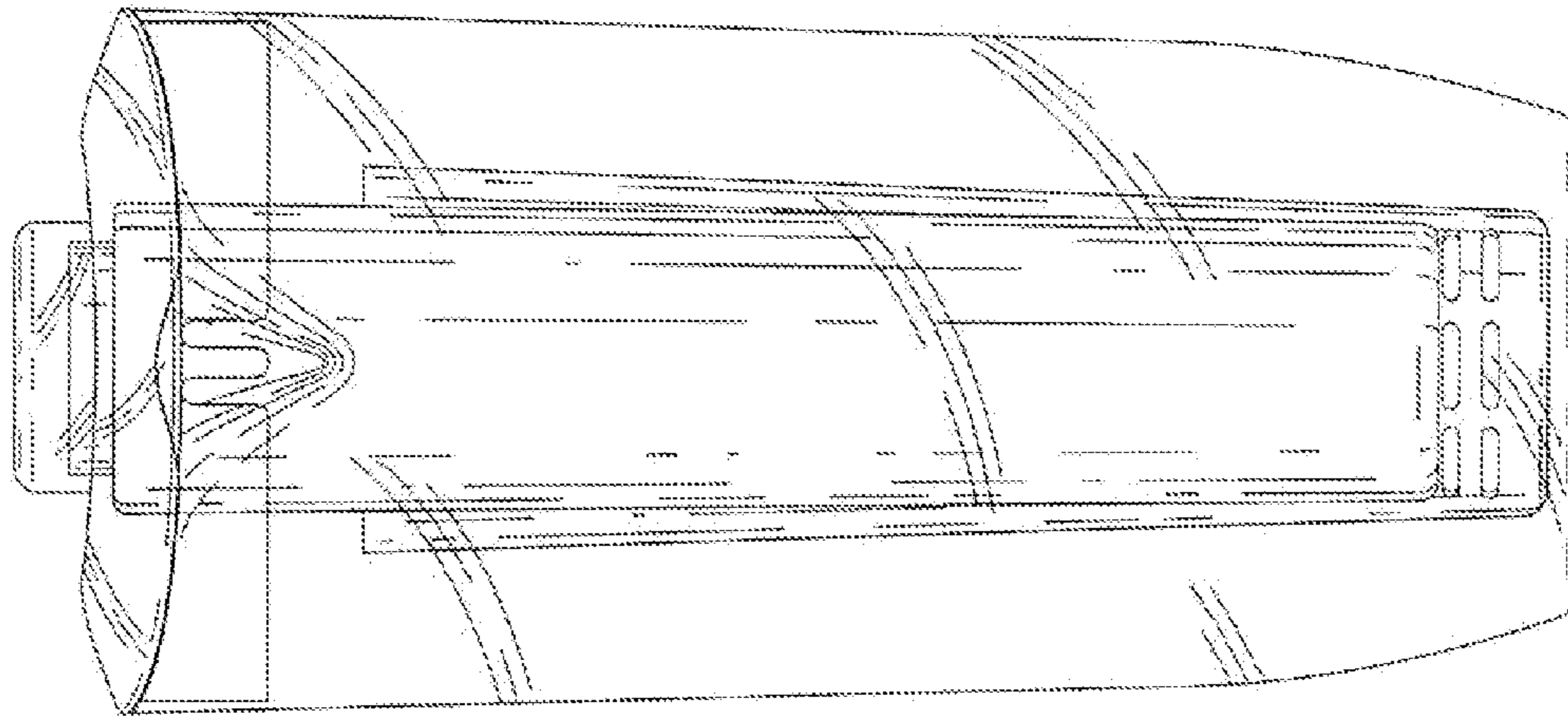

Fig. 2

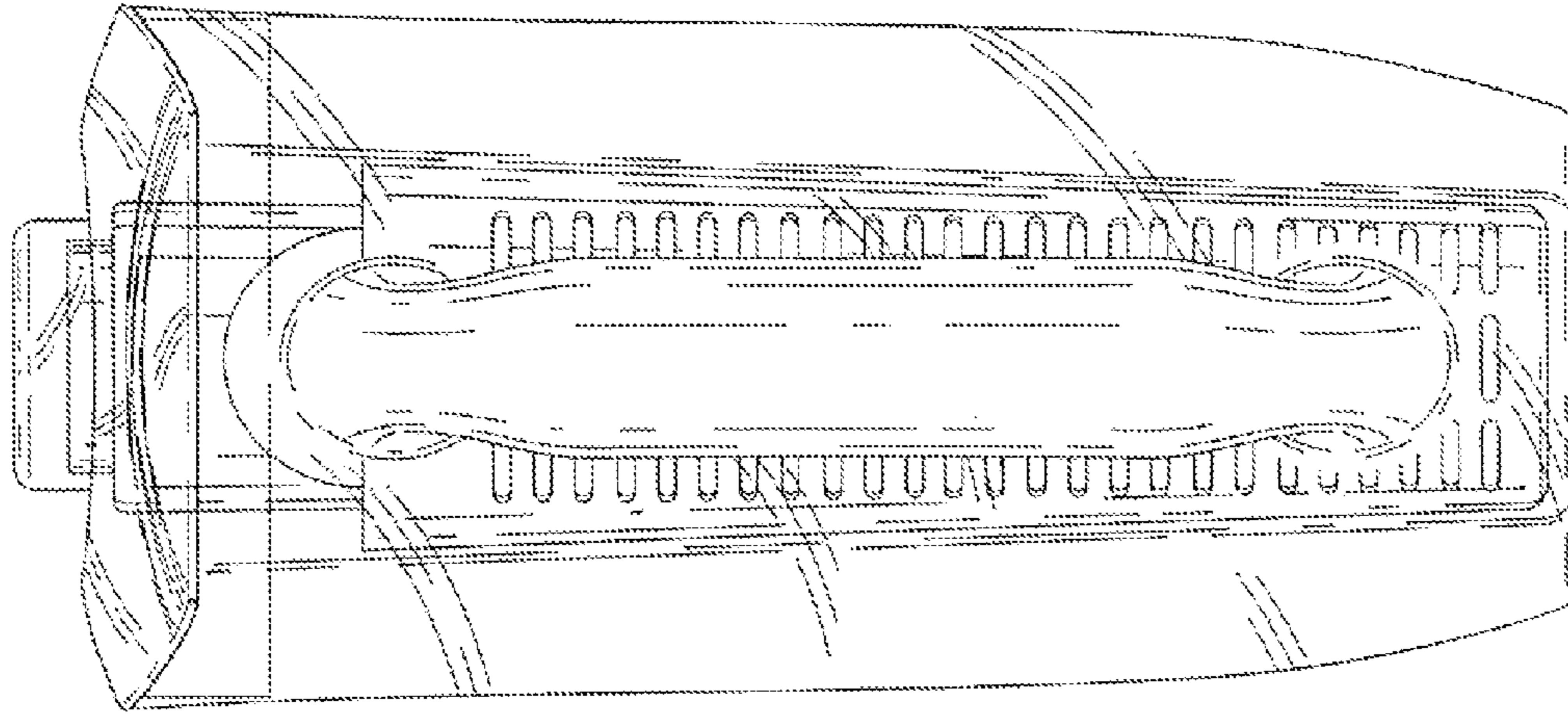

Fig. 4

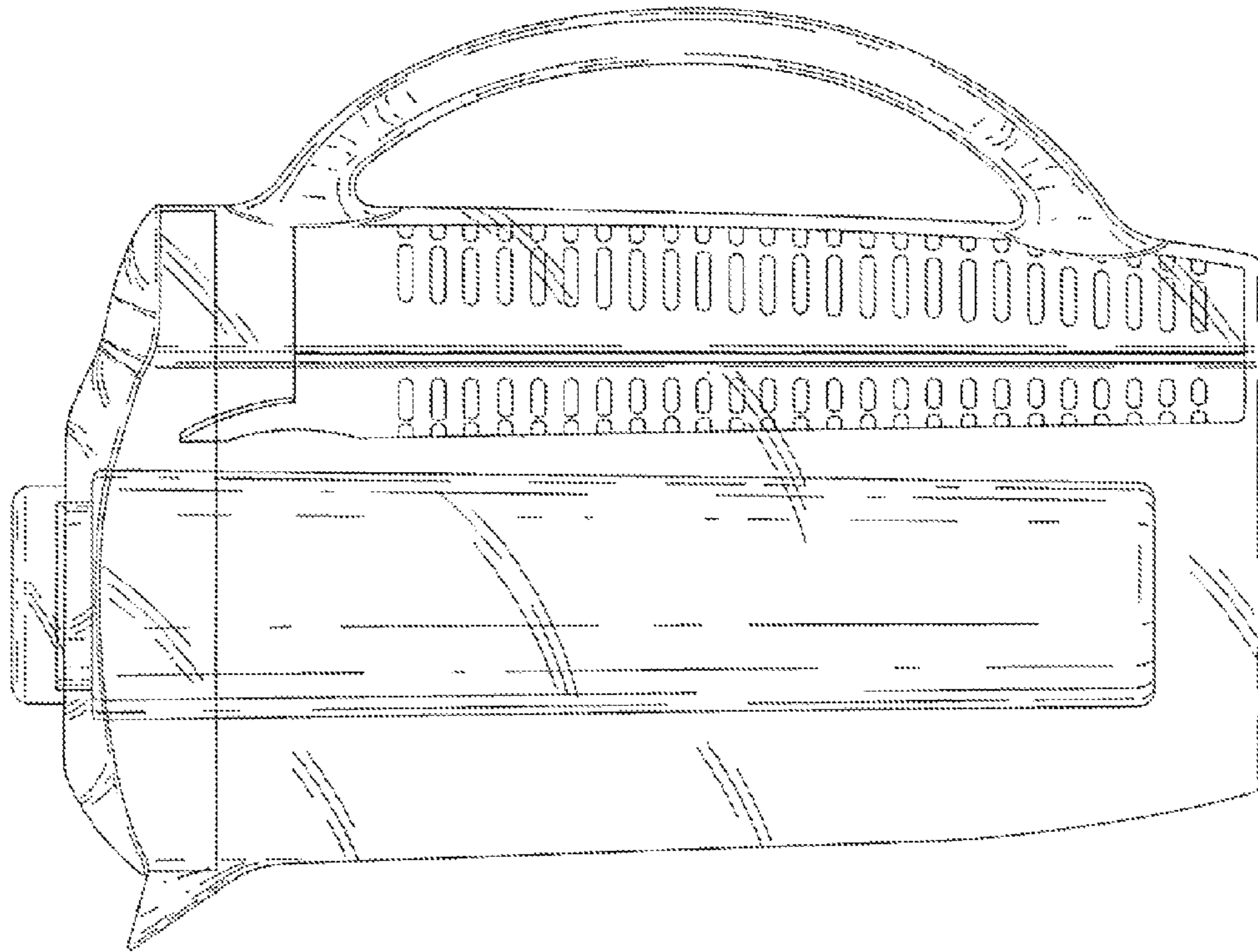

Fig. 3

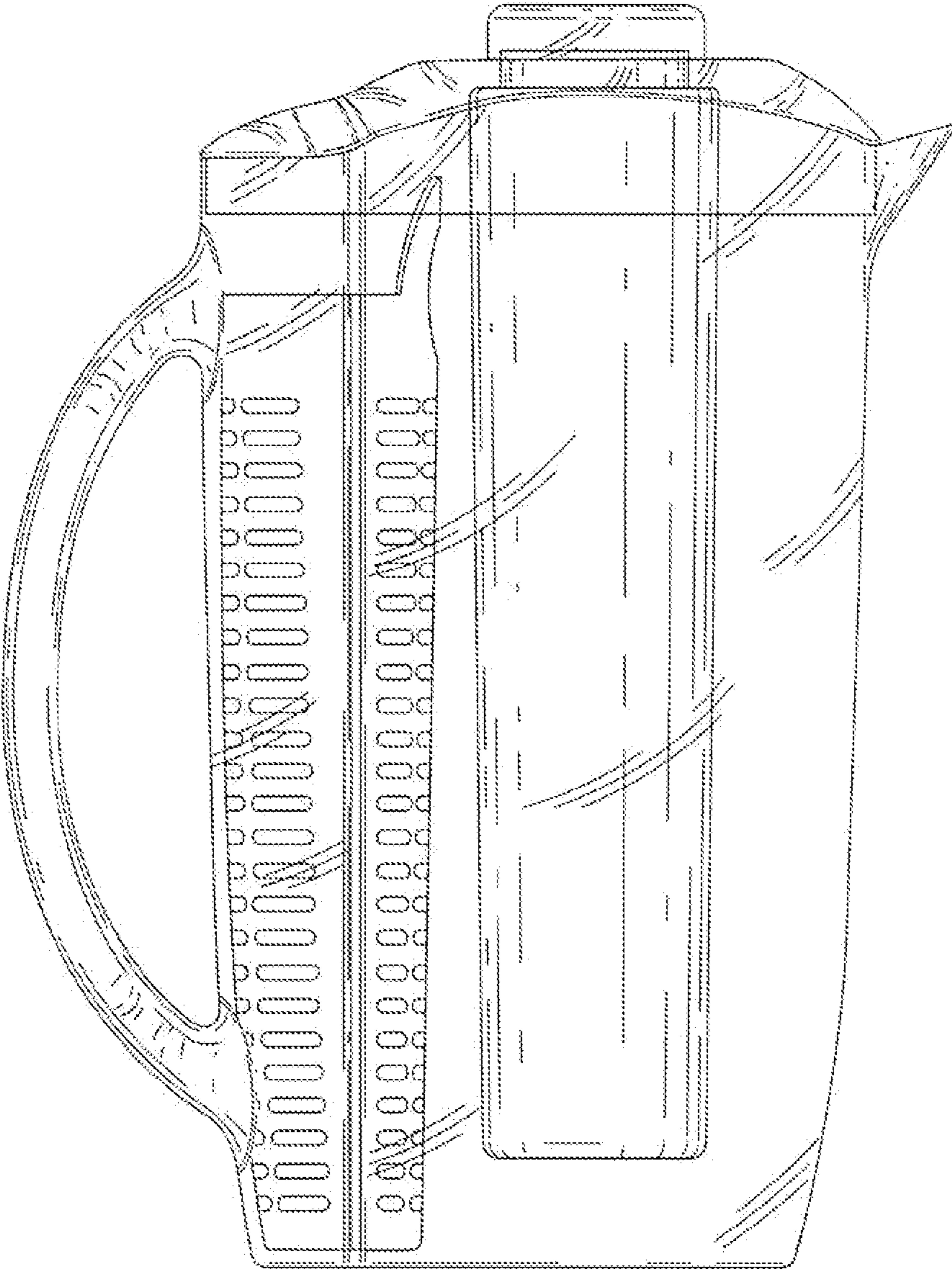

Fig. 5

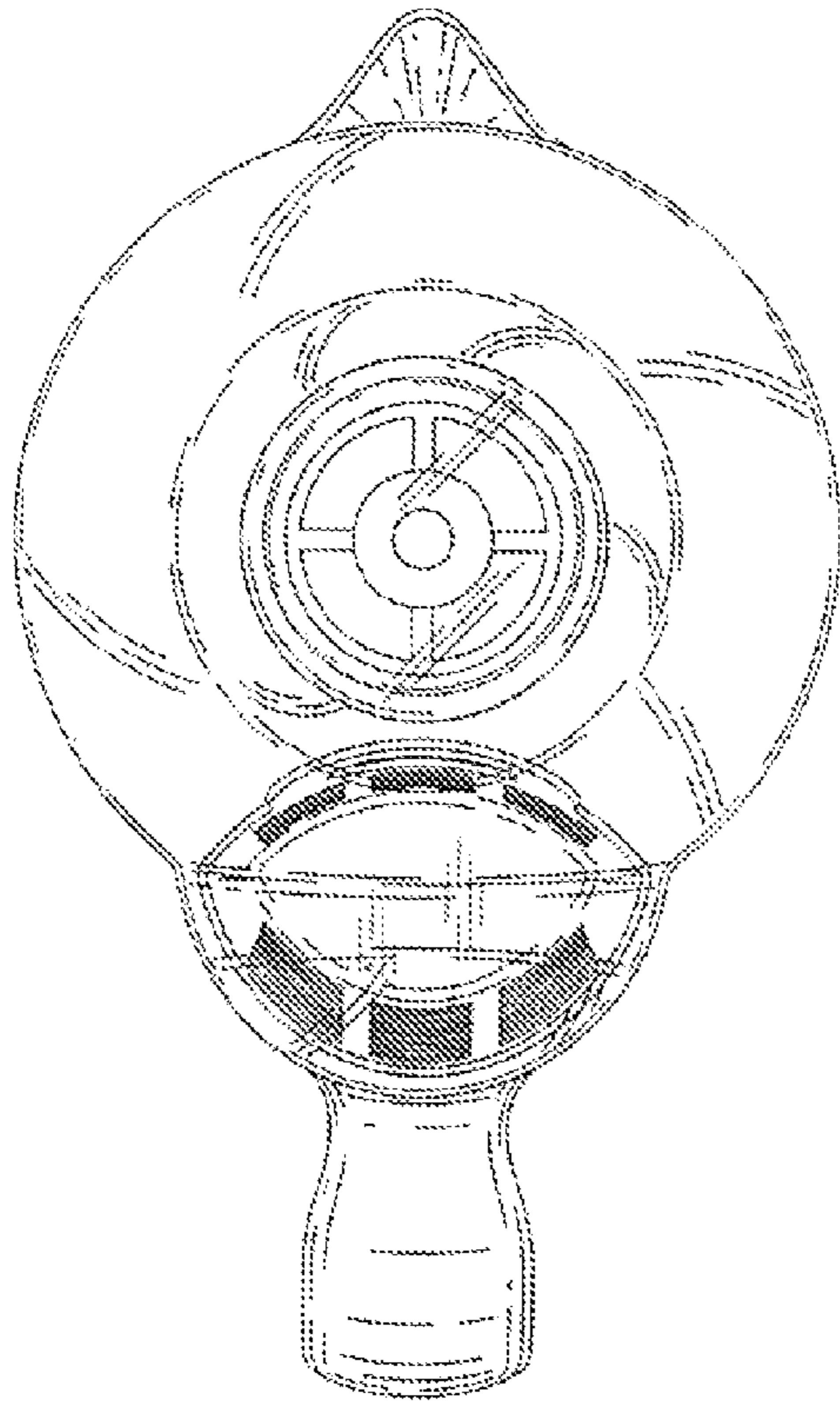

Fig. 6

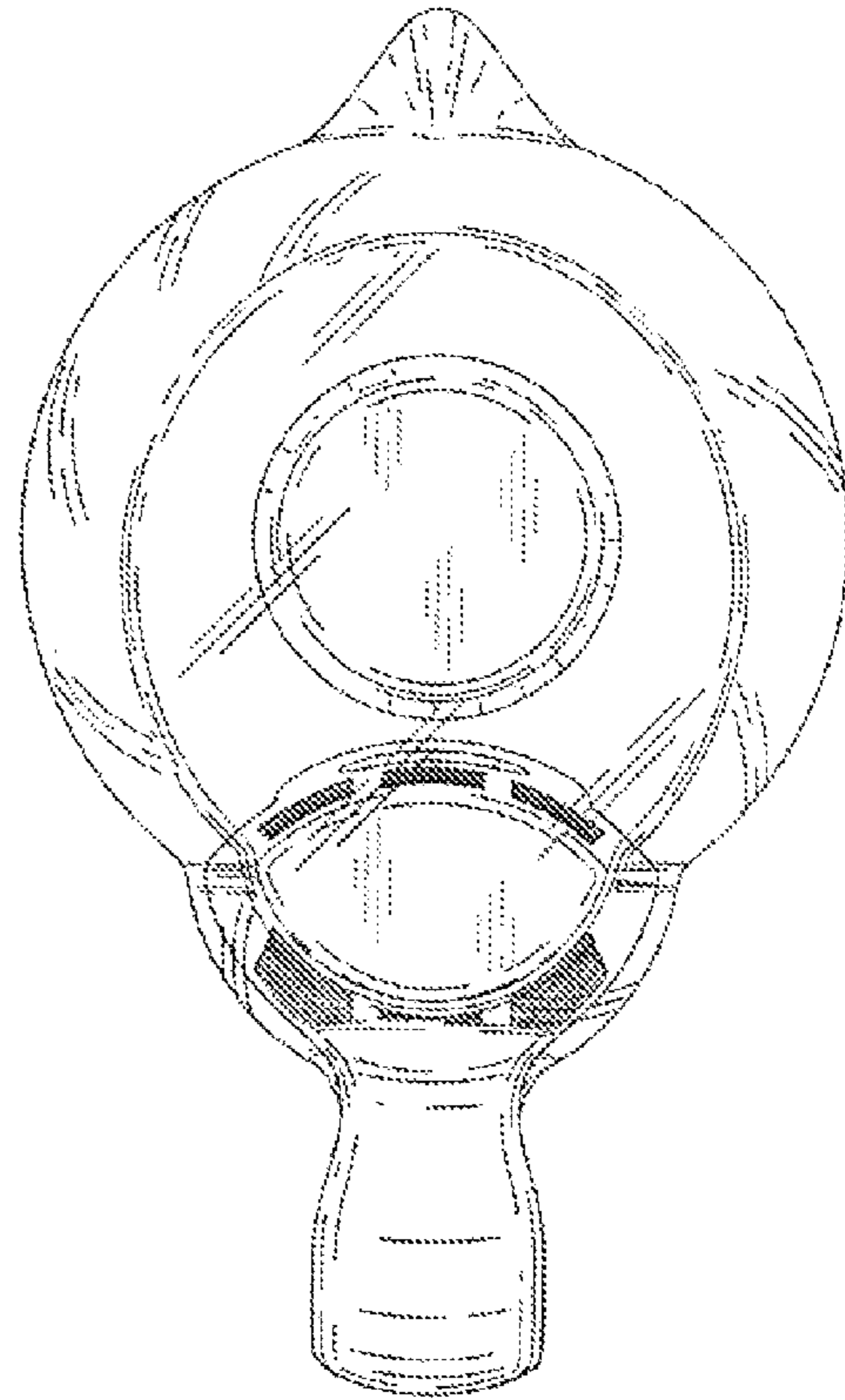

Fig. 7