



US00D633142S

(12) **United States Design Patent**
Chaffee et al.

(10) **Patent No.:** **US D633,142 S**

(45) **Date of Patent:** **** *Feb. 22, 2011**

(54) **WRITING INSTRUMENT WITH SHEET DISPENSER**

(75) Inventors: **Matthew D. Chaffee**, White Bear Lake, MN (US); **David C. Windorski**, Woodbury, MN (US); **Lee A. Fain**, St. Paul, MN (US)

(73) Assignee: **3M Innovative Properties Company**, St. Paul, MN (US)

(*) Notice: This patent is subject to a terminal disclaimer.

(**) Term: **14 Years**

(21) Appl. No.: **29/343,640**

(22) Filed: **Sep. 16, 2009**

(51) **LOC (9) Cl.** **19-06**

(52) **U.S. Cl.** **D19/36**

(58) **Field of Classification Search** D19/35, D19/36, 41-51, 53-57; 24/11 R, 11 F, 11 P; 401/52, 99, 100, 104-109, 192, 195, 196
See application file for complete search history.

(56) **References Cited**

U.S. PATENT DOCUMENTS

D198,419 S	6/1964	Hankins	
D424,109 S	5/2000	Edgerley et al.	
6,719,472 B2 *	4/2004	Windorski et al.	401/195
D492,349 S *	6/2004	Qiu	D19/50
D500,080 S	12/2004	Katami	
D502,507 S *	3/2005	Wang	D19/50
7,114,870 B2 *	10/2006	Windorski et al.	401/195
D540,386 S *	4/2007	Qiu	D19/51
D543,237 S *	5/2007	Bickert et al.	D19/42

D546,881 S *	7/2007	Qiu	D19/50
D565,102 S *	3/2008	Anand	D19/50
D581,978 S	12/2008	Windorski et al.	
D583,864 S *	12/2008	Liu	D19/48
D588,194 S *	3/2009	Booker	D19/50
7,517,167 B2 *	4/2009	Smith et al.	401/195
D598,557 S *	8/2009	Powaser	D24/192
D605,701 S *	12/2009	Zhang	D19/50
D609,742 S *	2/2010	Lee	D19/36
D612,886 S *	3/2010	Newbould et al.	D19/36
D613,738 S *	4/2010	Daniel	D14/346
2005/0191114 A1 *	9/2005	Smith et al.	401/195

FOREIGN PATENT DOCUMENTS

EM	000879010-0001	3/2008
KR	10/2006-0111199	10/2006

* cited by examiner

Primary Examiner—Elizabeth A Albert

(74) *Attorney, Agent, or Firm*—Robert H. Jordan

(57) **CLAIM**

The ornamental design for a writing instrument with sheet dispenser, as shown and described.

DESCRIPTION

FIG. 1 is a perspective view showing the new design for a writing instrument with sheet dispenser;

FIG. 2 is a right side view thereof, the left side view being a mirror image;

FIG. 3 is a bottom plan view thereof;

FIG. 4 is a top plan view thereof;

FIG. 5 is a rear view thereof; and,

FIG. 6 is a front view thereof.

1 Claim, 2 Drawing Sheets

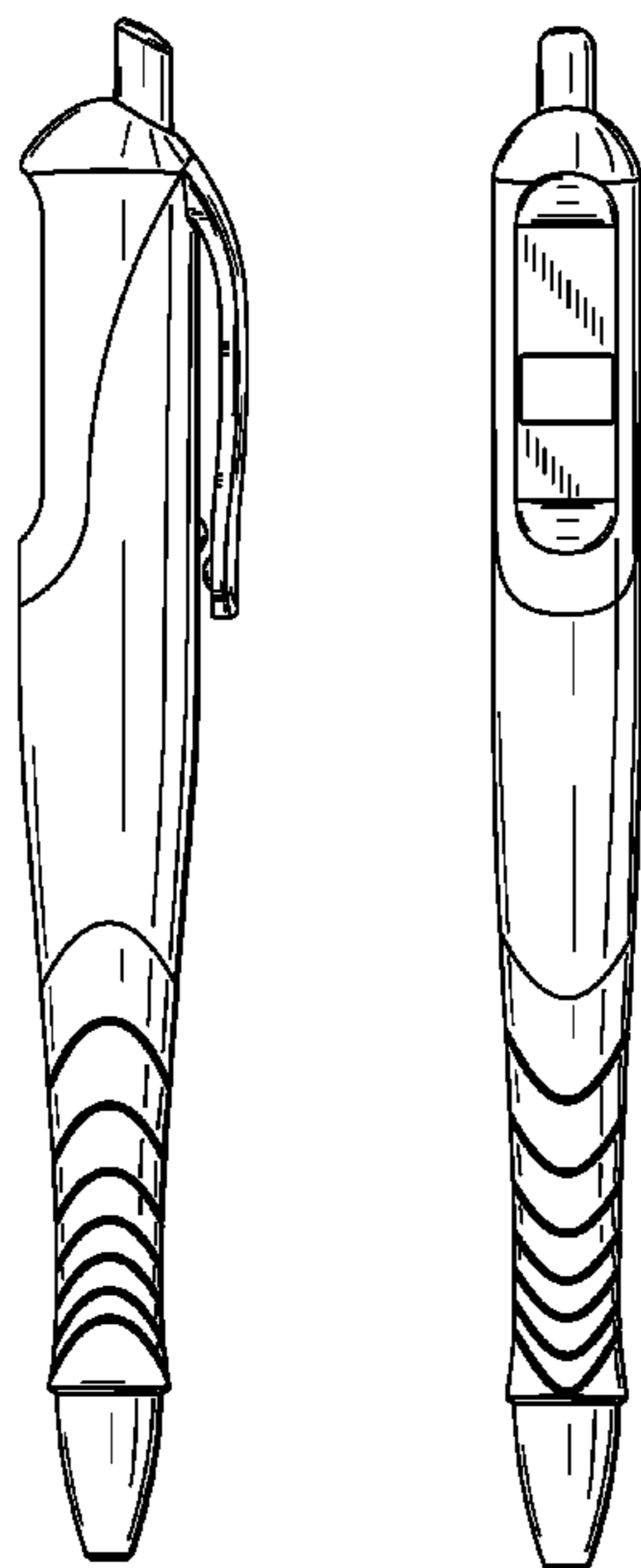

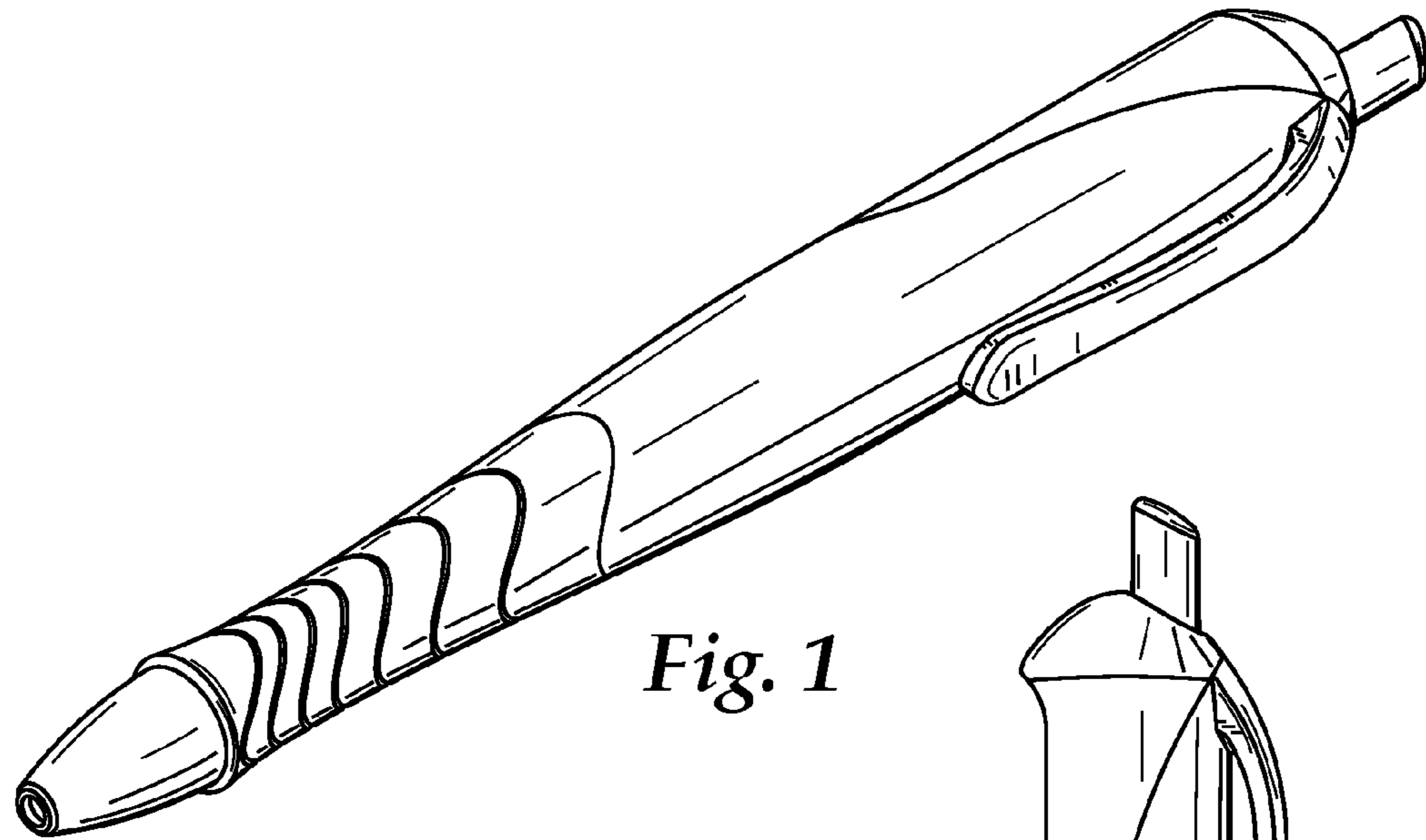

Fig. 1

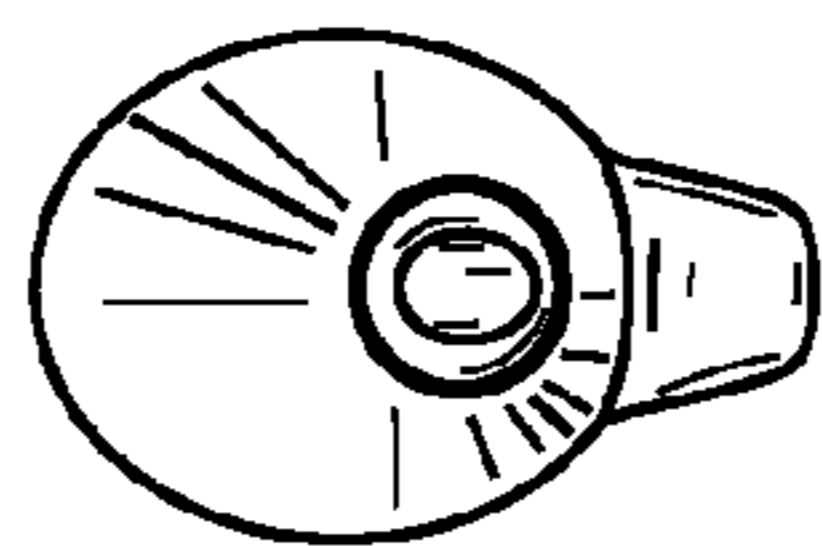

Fig. 5

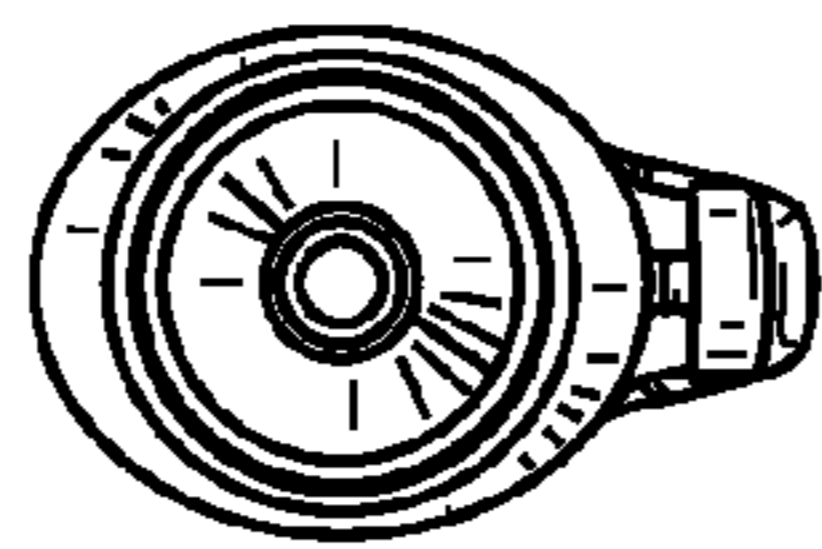

Fig. 6

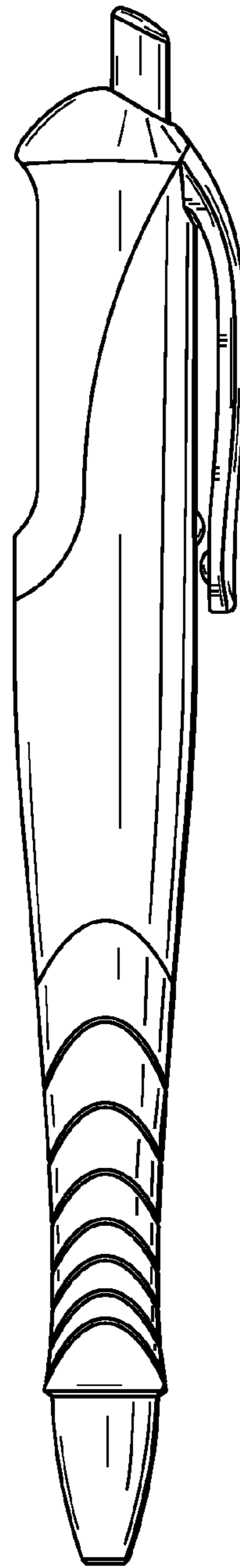

Fig. 2

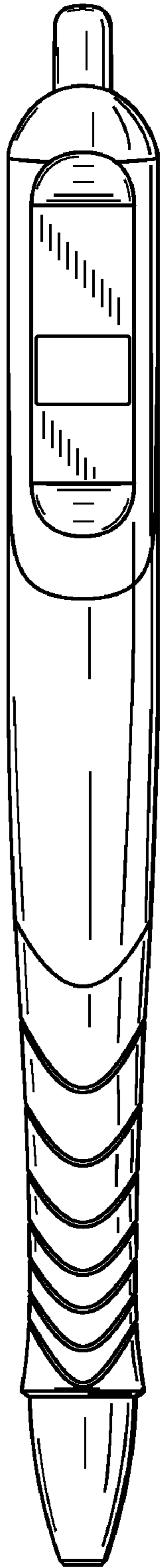

Fig. 3

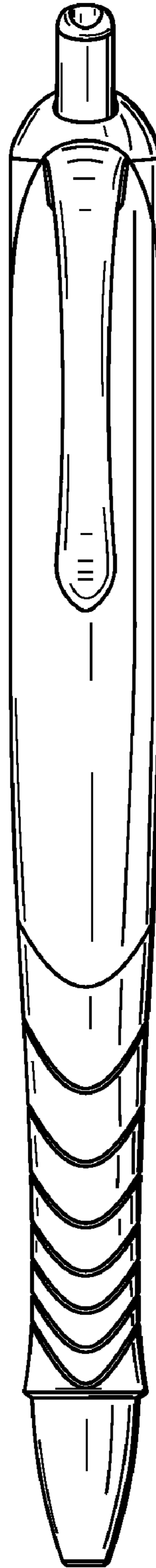

Fig. 4