

US00D633128S

(12) **United States Design Patent**
Fuchs

(10) **Patent No.:** **US D633,128 S**

(45) **Date of Patent:** **** Feb. 22, 2011**

(54) **EYEGLASSES**

(75) Inventor: **Gerhard Fuchs**, Kauns (AT)

(73) Assignee: **Silhouette International Schmied AG**
(AT)

(**) Term: **14 Years**

(21) Appl. No.: **29/365,371**

(22) Filed: **Jul. 8, 2010**

(30) **Foreign Application Priority Data**

Mar. 25, 2010 (EM) 001686619

(51) **LOC (9) Cl.** **16-06**

(52) **U.S. Cl.** **D16/311; D16/315; D16/334**

(58) **Field of Classification Search** D16/101,
D16/300-342; D29/109-110; D24/110.2;
351/41, 44, 51-52, 62, 158, 92, 103-123,
351/140, 153, 45-46; 2/426-432, 447-449,
2/441, 434-437, 13, 15; D21/483, 659-661
See application file for complete search history.

(56) **References Cited**

U.S. PATENT DOCUMENTS

D218,572 S *	9/1970	Simon	D16/321
D285,092 S *	8/1986	Baum	D16/335
D305,900 S *	2/1990	Samuel	D16/320
D354,505 S *	1/1995	Francavilla	D16/335
D429,752 S *	8/2000	Polland	D16/315
6,655,800 B2 *	12/2003	Takeda et al.	351/110
6,729,725 B1 *	5/2004	Cheng	351/110
D533,579 S *	12/2006	Raile	D16/316
D556,814 S	12/2007	Serlenga		
D563,453 S	3/2008	Serlenga		
D573,170 S	7/2008	Fuchs		

D581,448 S	11/2008	Fuchs
D582,965 S	12/2008	Fuchs
D591,788 S	5/2009	Fuchs
D593,593 S	6/2009	Fuchs
D597,123 S	7/2009	Strecker

* cited by examiner

Primary Examiner—Raphael Barkai

(74) *Attorney, Agent, or Firm*—Alston & Bird LLP

(57) **CLAIM**

The ornamental design for eyeglasses, as shown and described.

DESCRIPTION

FIG. 1 is a perspective view of eyeglasses showing my new design;

FIG. 2 is a front elevation view thereof;

FIG. 3 is a rear elevation view thereof;

FIG. 4 is a top plan view thereof;

FIG. 5 is a bottom plan view thereof;

FIG. 6 is a left side elevation view thereof, the right side elevation view being a mirror image;

FIG. 7 is side elevation cross-section view thereof taken along line 7—7 in FIG. 4; and,

FIG. 8 is a cross-section portion of a front elevation view thereof taken along line 8—8 in FIG. 4.

The broken lines immediately adjacent shaded areas represent bounds of the claimed design and environment while all other broken lines are directed to environment and are for illustrative purposes only. The broken lines form no part of the claimed design.

1 Claim, 7 Drawing Sheets

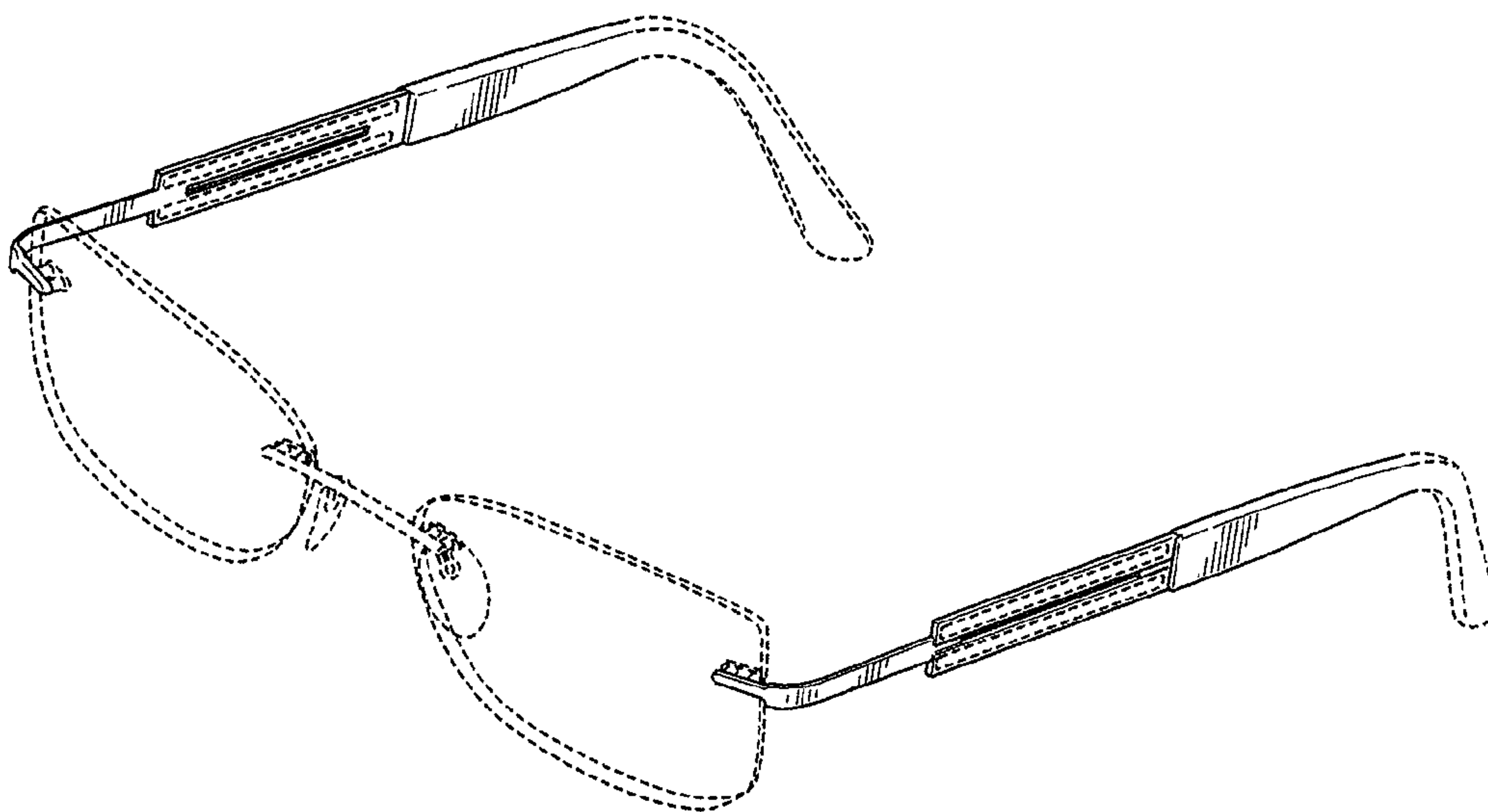

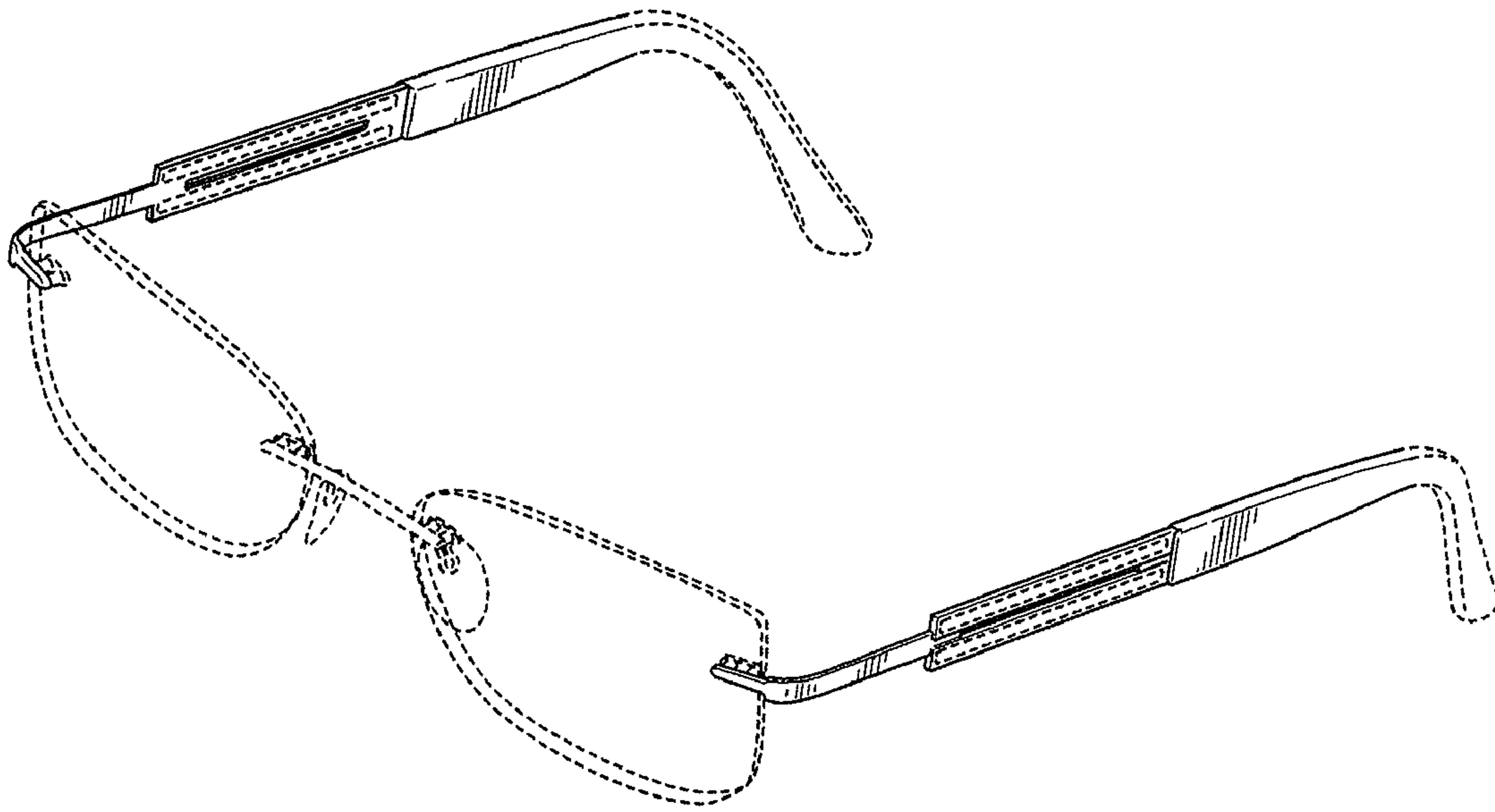

FIG. 1

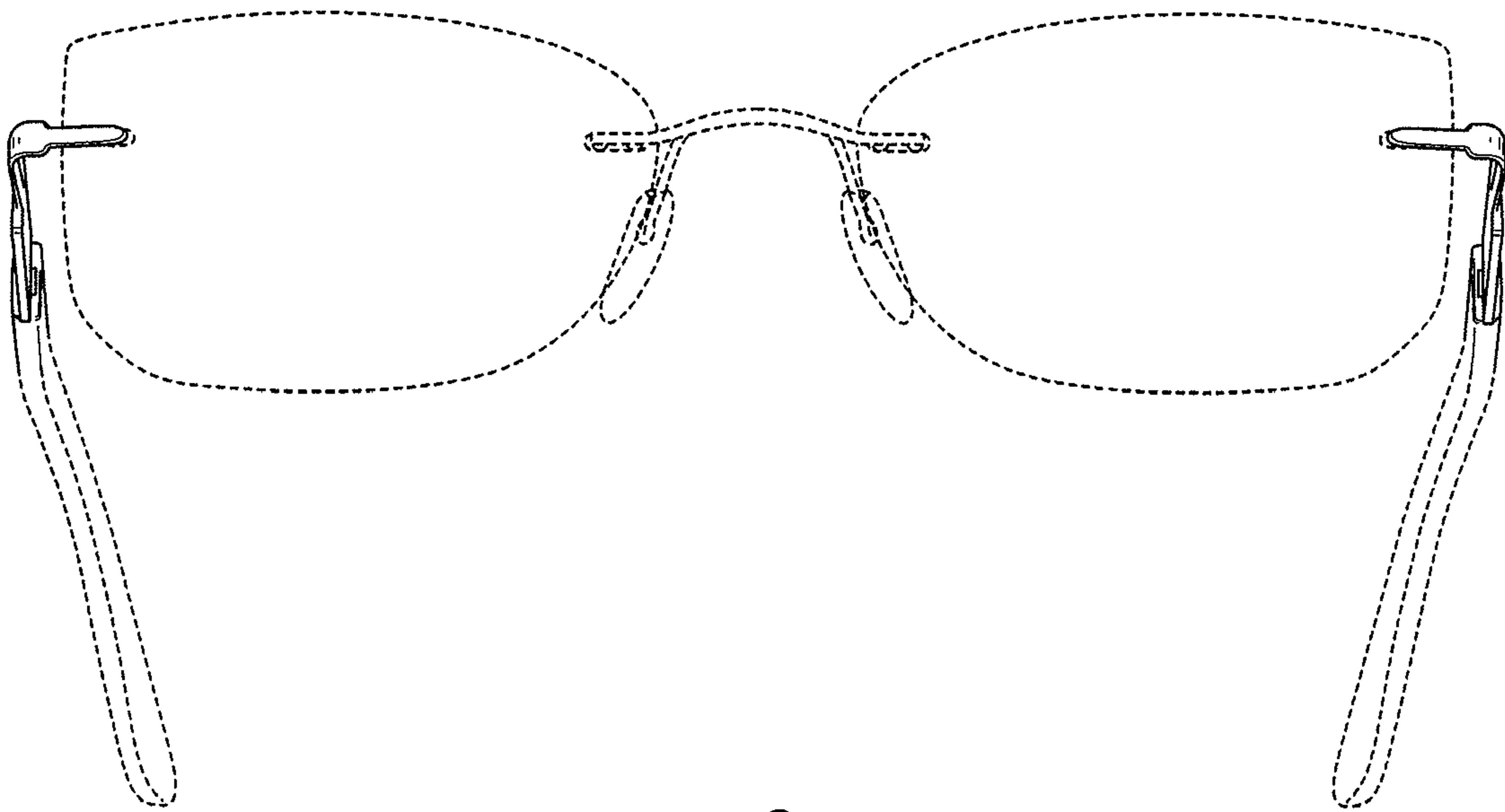

FIG. 2

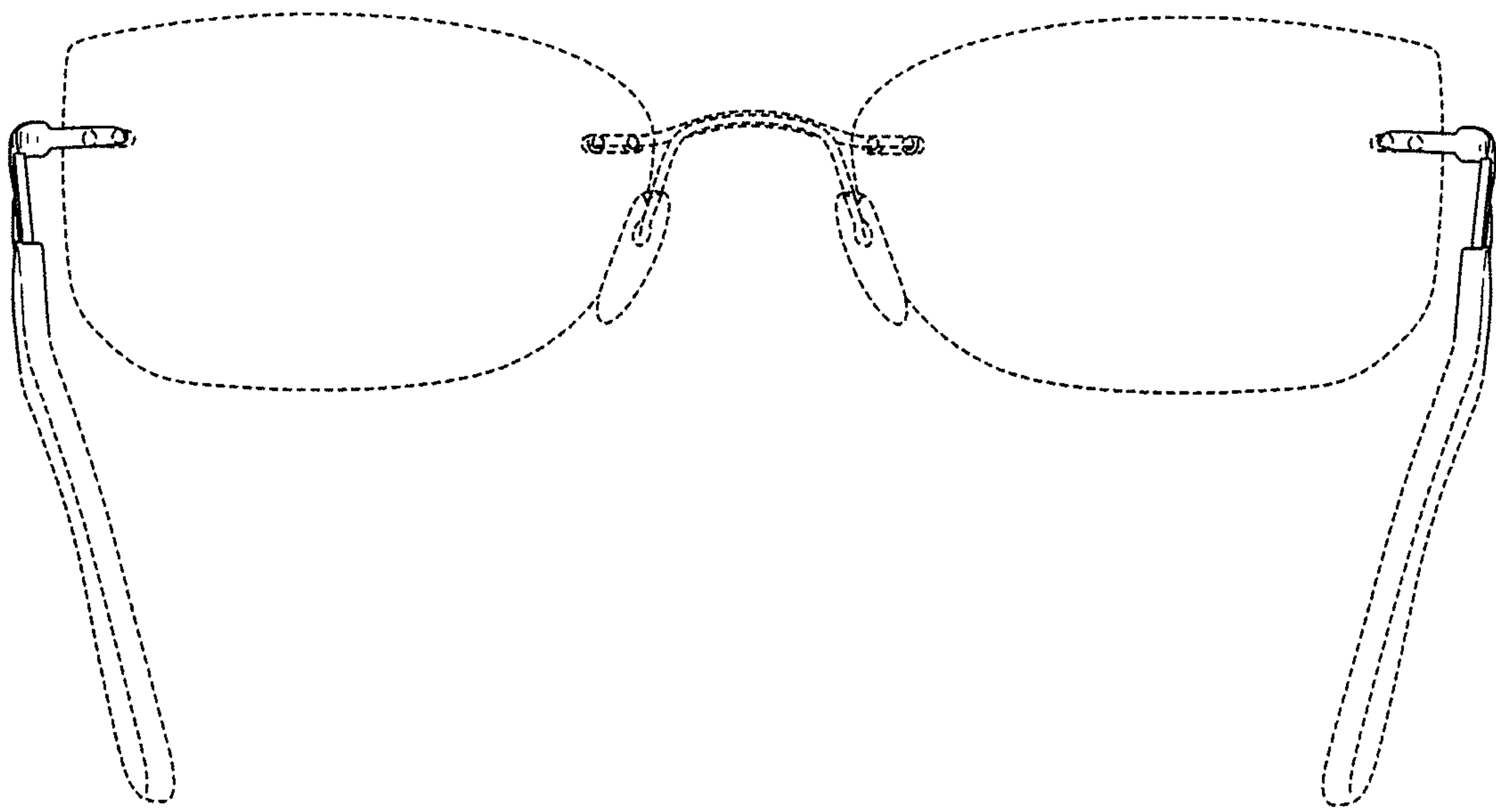

FIG. 3

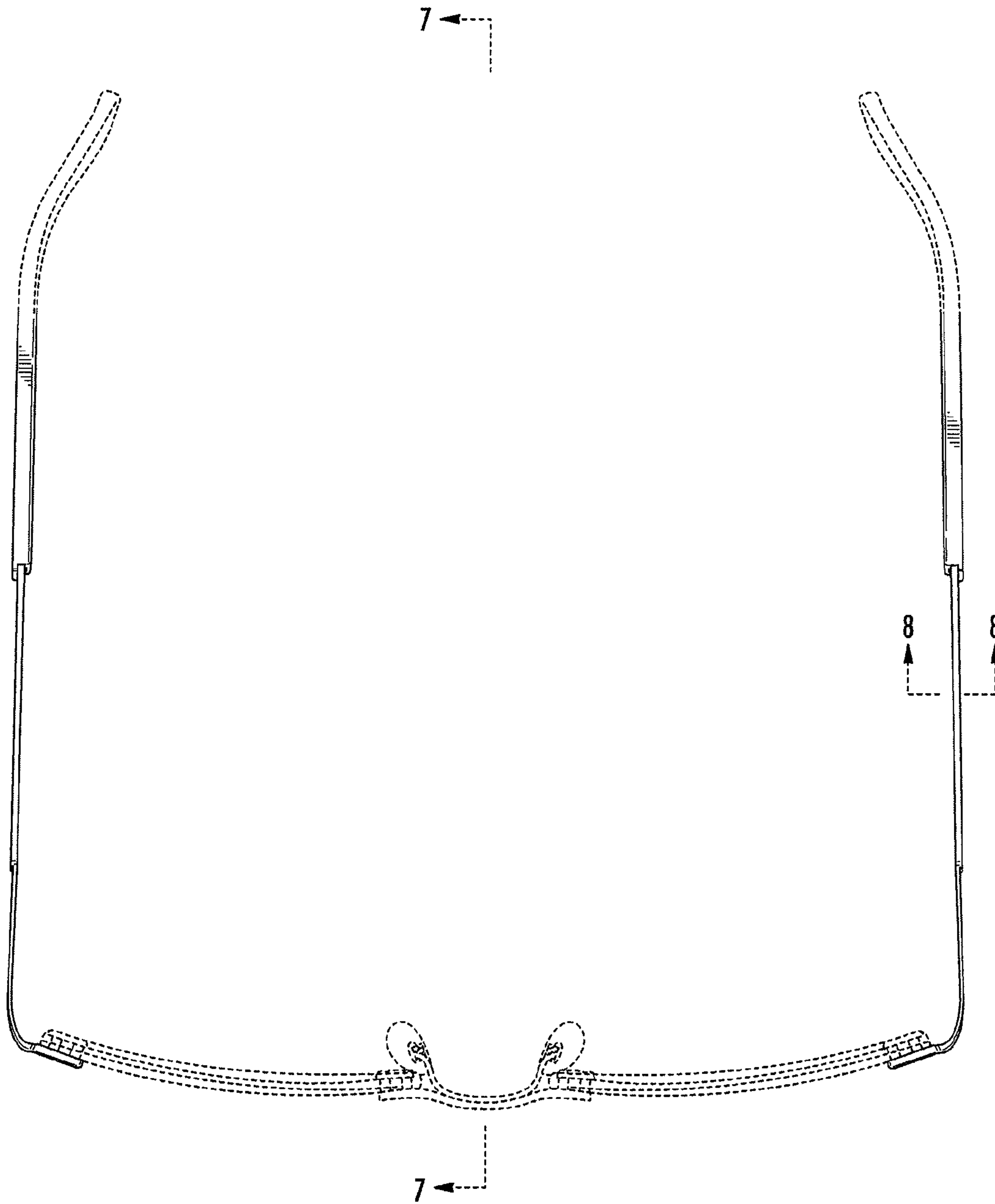

FIG. 4

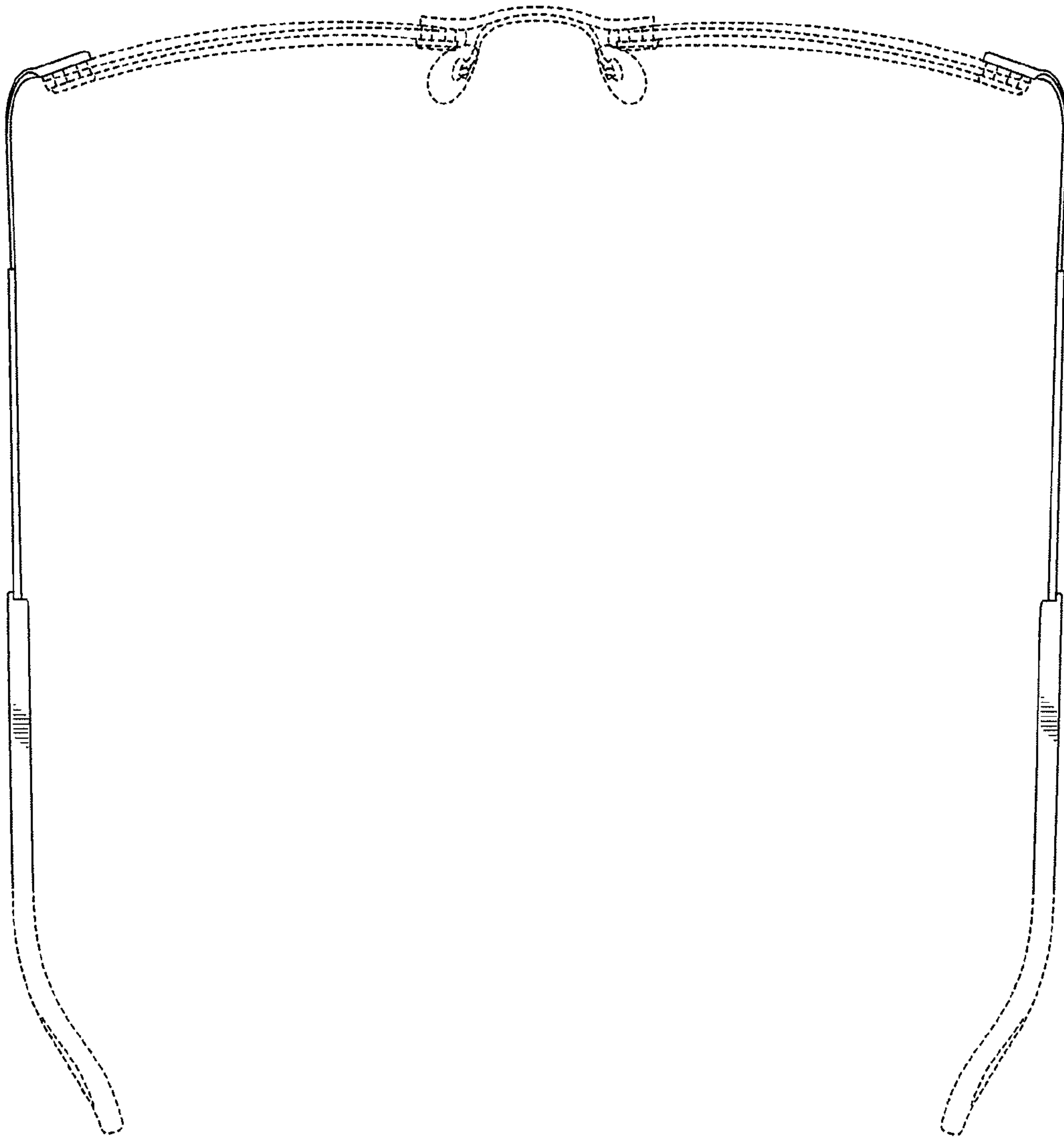

FIG. 5

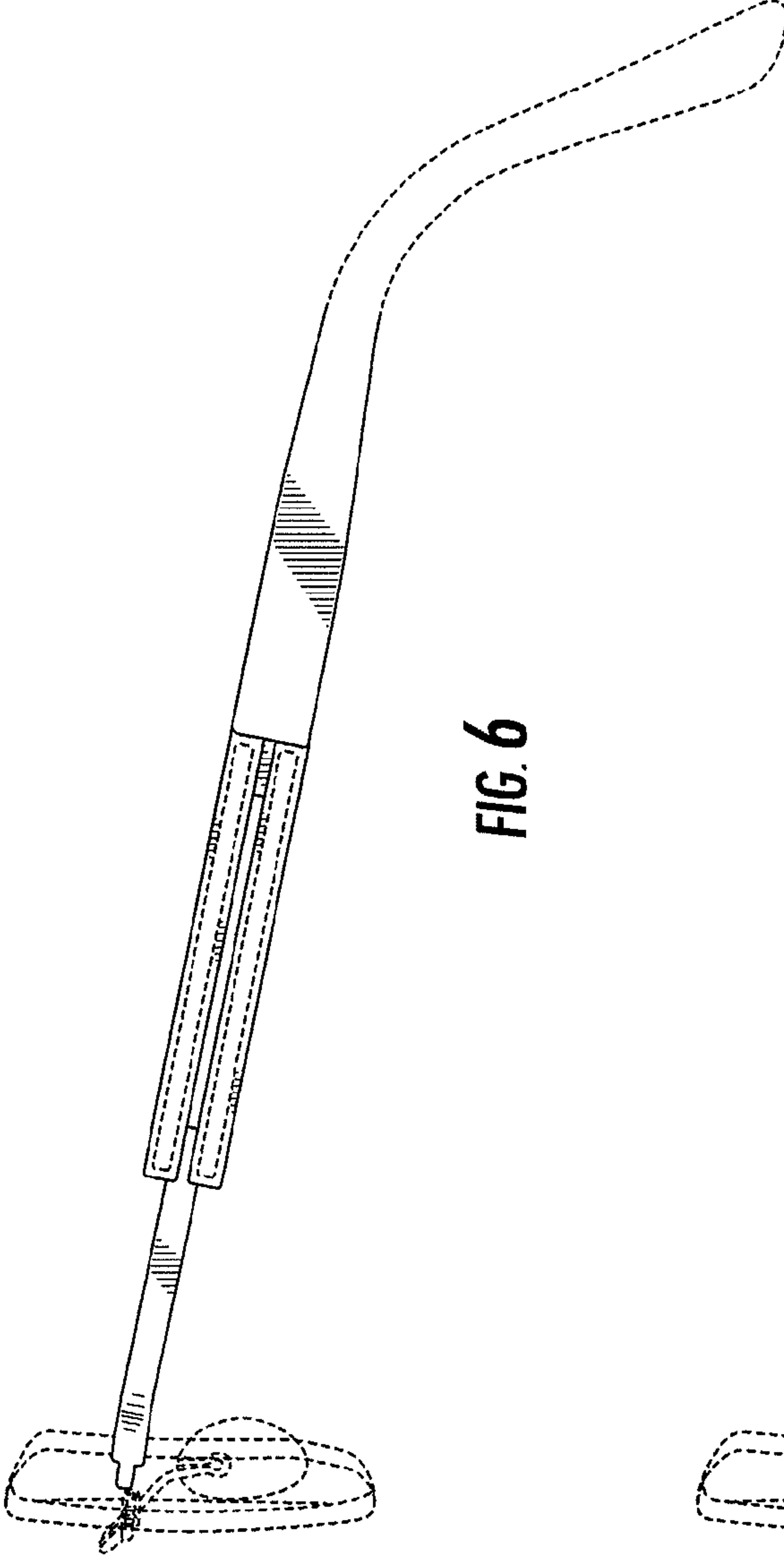

FIG. 6

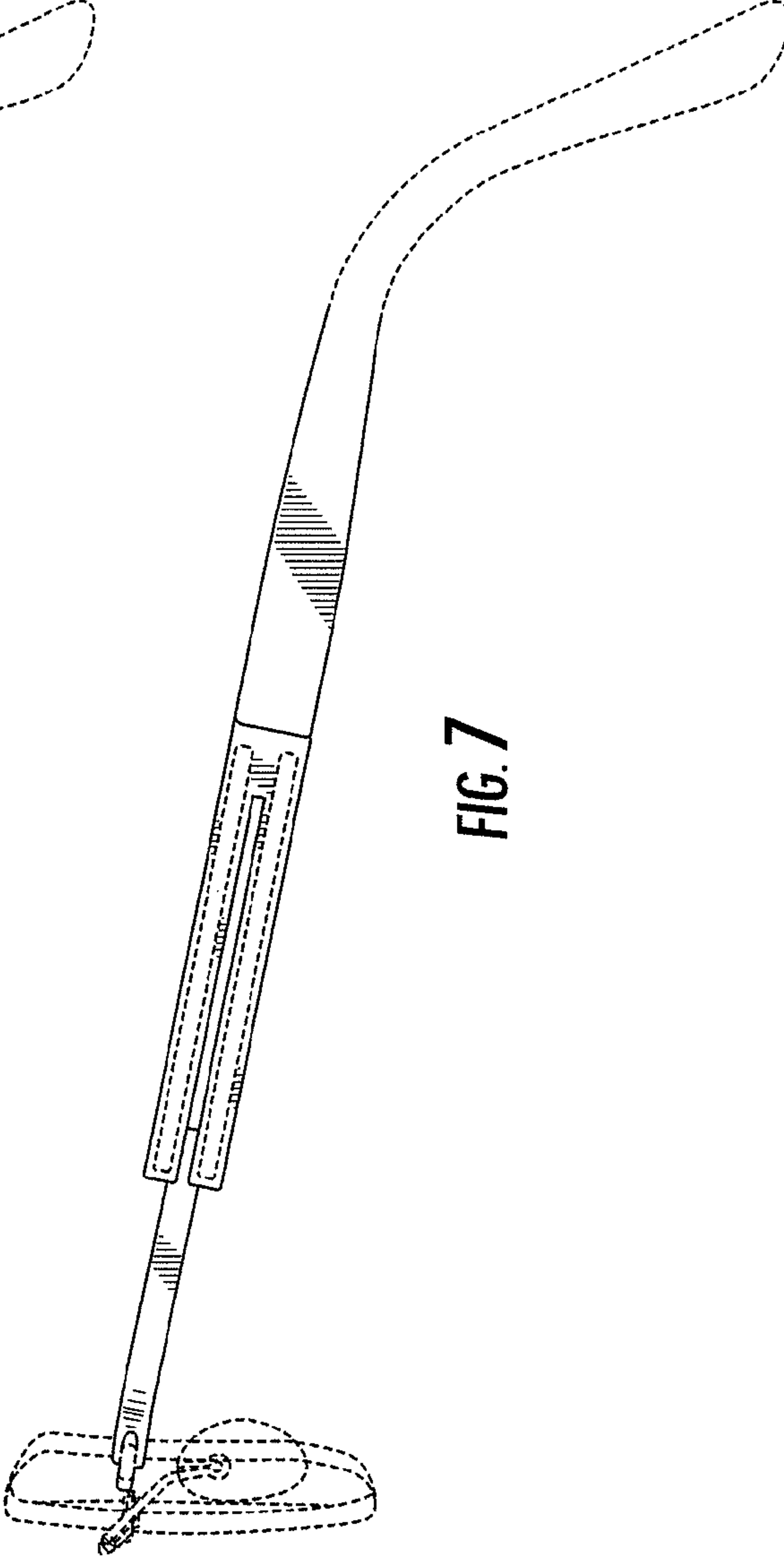

FIG. 7

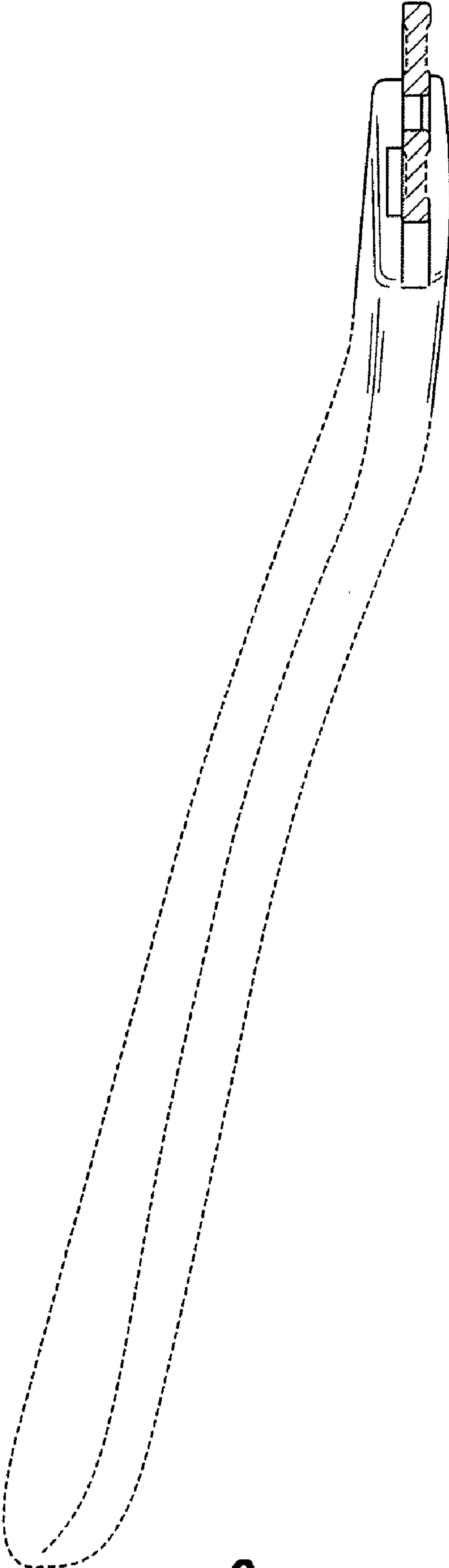

FIG. 8