



US00D632955S

(12) **United States Design Patent**
Smith, III et al.

(10) **Patent No.:** **US D632,955 S**
(45) **Date of Patent:** **** Feb. 22, 2011**

(54) **CLAMSHELL PACKAGE**

(75) Inventors: **George W. Smith, III**, Barrington, IL (US); **Mark W. Sprenger**, Elk Grove Villiage, IL (US)

(73) Assignee: **Interactive Vending Corporation**, Barrington, IL (US)

(**) Term: **14 Years**

(21) Appl. No.: **29/362,400**

(22) Filed: **May 25, 2010**

(51) **LOC (9) Cl.** **09-03**

(52) **U.S. Cl.** **D9/415**

(58) **Field of Classification Search** D9/414-435,
D9/456, 457, 499, 715, 720-722; 206/461-471,
206/806, 815

See application file for complete search history.

(56) **References Cited**

U.S. PATENT DOCUMENTS

3,251,390	A *	5/1966	Evans	383/17
D209,867	S *	1/1968	Sigoloff	D9/418
D257,585	S *	12/1980	Neuwirth	D9/425
D268,331	S *	3/1983	Kay et al.	D9/415
4,496,052	A *	1/1985	Nertman	206/470
4,570,818	A *	2/1986	Borst et al.	220/835
4,687,129	A *	8/1987	Cugley	220/315
4,694,960	A *	9/1987	Phipps et al.	206/469
4,771,934	A *	9/1988	Kalmanides	229/406
D305,408	S	1/1990	LaJoie	
D306,561	S	3/1990	Lee	
D329,600	S	9/1992	LaJoie	
5,291,995	A *	3/1994	von Agris et al.	206/336
D393,799	S *	4/1998	Pope et al.	D9/415
D401,765	S *	12/1998	Soutullo	D4/199

(Continued)

Primary Examiner—Catherine Tuttle

(74) *Attorney, Agent, or Firm*—K&L Gates LLP

(57) **CLAIM**

The ornamental design for a clamshell package, as shown and described.

DESCRIPTION

FIG. 1 is a front perspective view showing a first embodiment of our new design for a clamshell package;

FIG. 2 is a front elevational view of FIG. 1;

FIG. 3 is a top plan view of FIG. 1;

FIG. 4 is a right side elevational view of FIG. 1, the left side elevational view being a mirror image thereof;

FIG. 5 is a rear view of FIG. 1;

FIG. 6 is a bottom view of FIG. 1;

FIG. 7 is a front perspective view showing a second embodiment of our new design for a clamshell package;

FIG. 8 is a front elevational view of FIG. 7;

FIG. 9 is a top plan view of FIG. 7;

FIG. 10 is a right side elevational view of FIG. 7, the left side elevational view being a mirror image thereof;

FIG. 11 is a rear view of FIG. 7;

FIG. 12 is a bottom view of FIG. 7;

FIG. 13 is a front perspective view showing a third embodiment of our new design for a clamshell package;

FIG. 14 is a front elevational view of FIG. 13;

FIG. 15 is a top plan view of FIG. 13;

FIG. 16 is a right side elevational view of FIG. 13, the left side elevational view being a mirror image thereof;

FIG. 17 is a rear view of FIG. 13; and,

FIG. 18 is a bottom view of FIG. 13.

The broken lines shown in FIGS. 13, 14 and 17 are included for the purpose of illustrating portions of the clamshell package that form no part of the claim to the third embodiment.

1 Claim, 18 Drawing Sheets

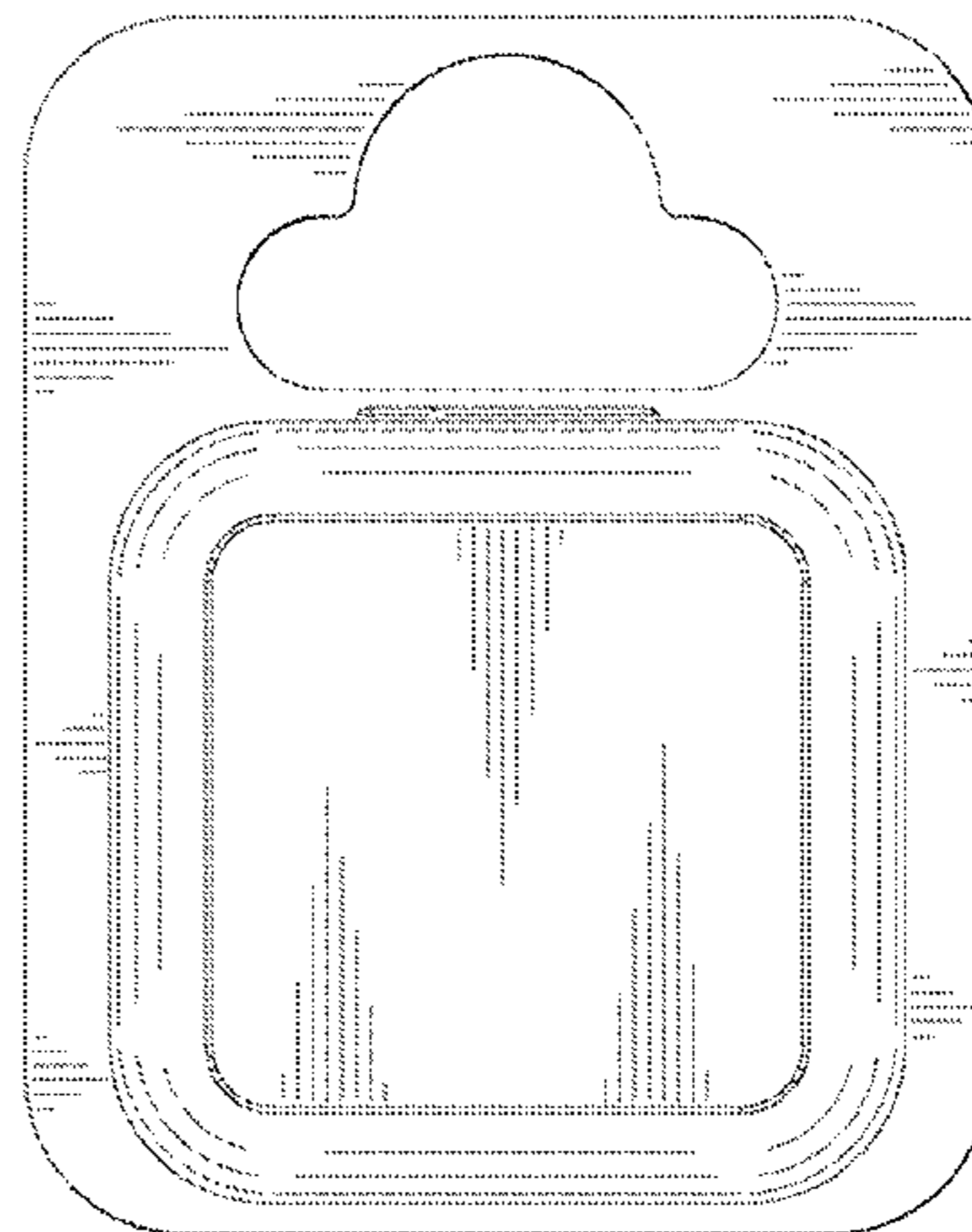
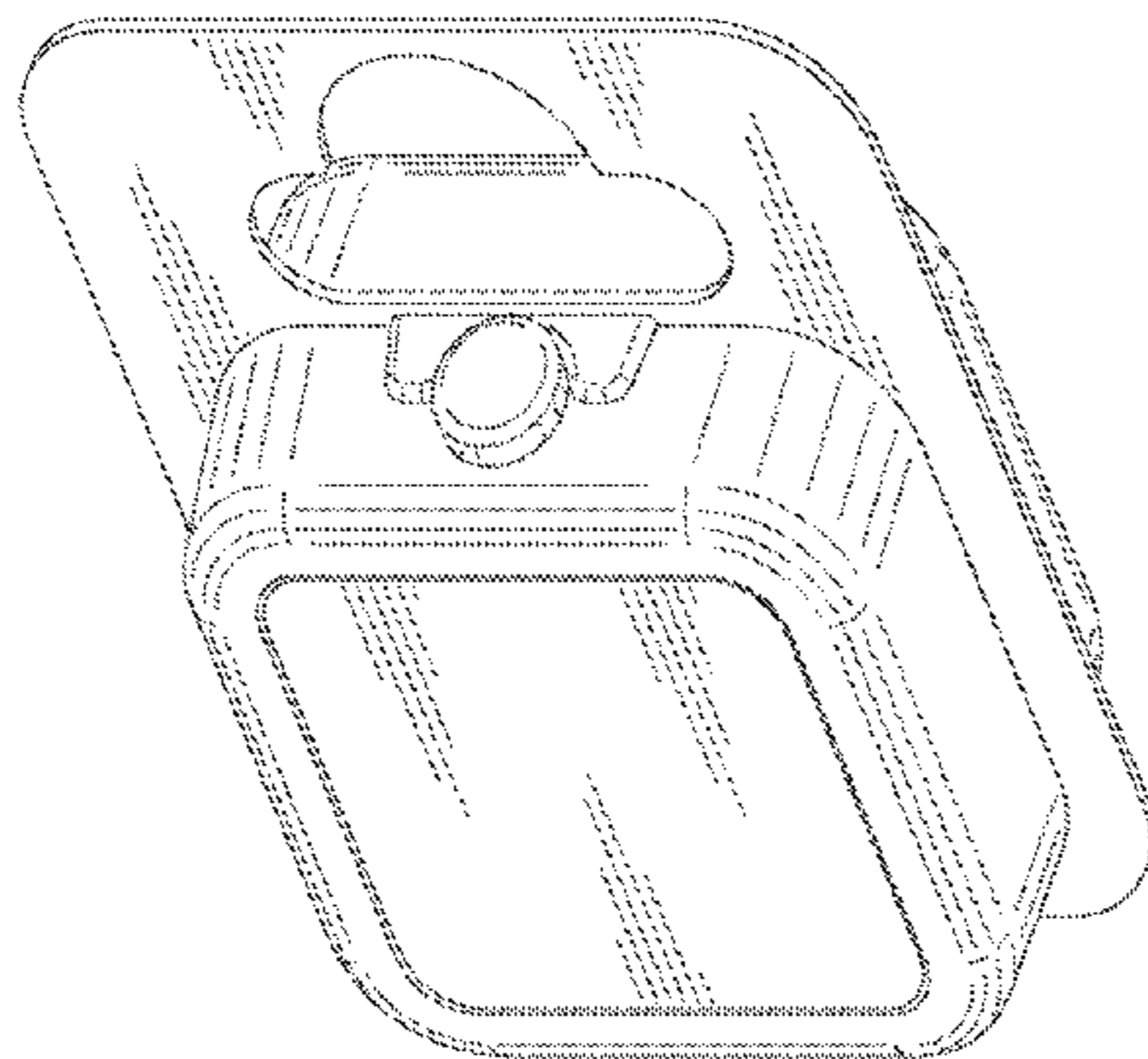

US D632,955 S

Page 2

U.S. PATENT DOCUMENTS

D434,315 S	11/2000	Clarke		D558,043 S	12/2007	Kiser	
D445,330 S	7/2001	Clarke, III		D584,606 S	1/2009	Wintolders et al.	
6,830,149 B2 *	12/2004	Merboth et al.	206/438	D596,935 S	7/2009	Golota et al.	
7,281,630 B2 *	10/2007	Hartman et al.	206/467	D601,013 S	9/2009	Petitjean	
				2007/0187488 A1 *	8/2007	Martinez et al.	235/380

* cited by examiner

FIG. 1

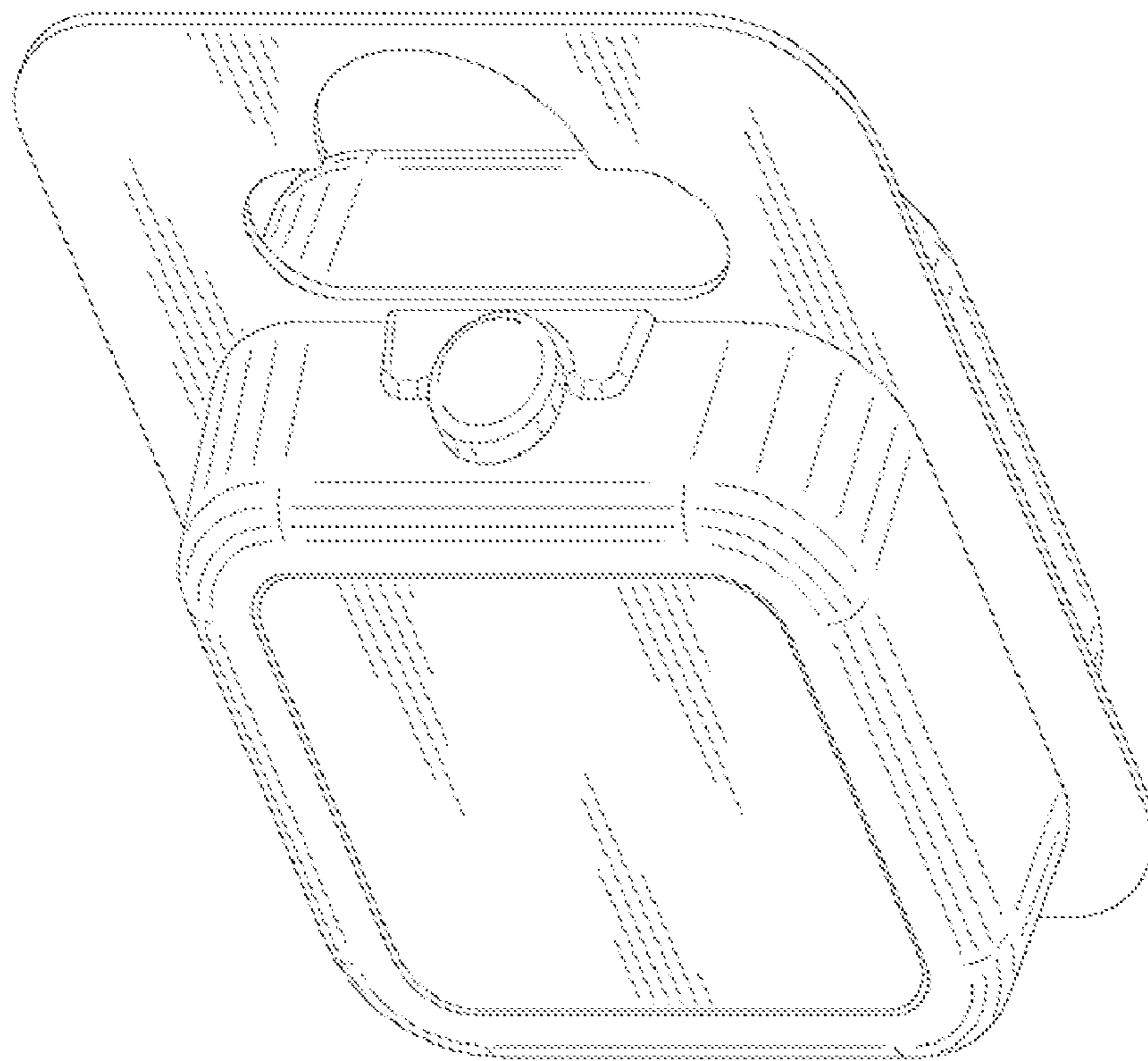

FIG. 2

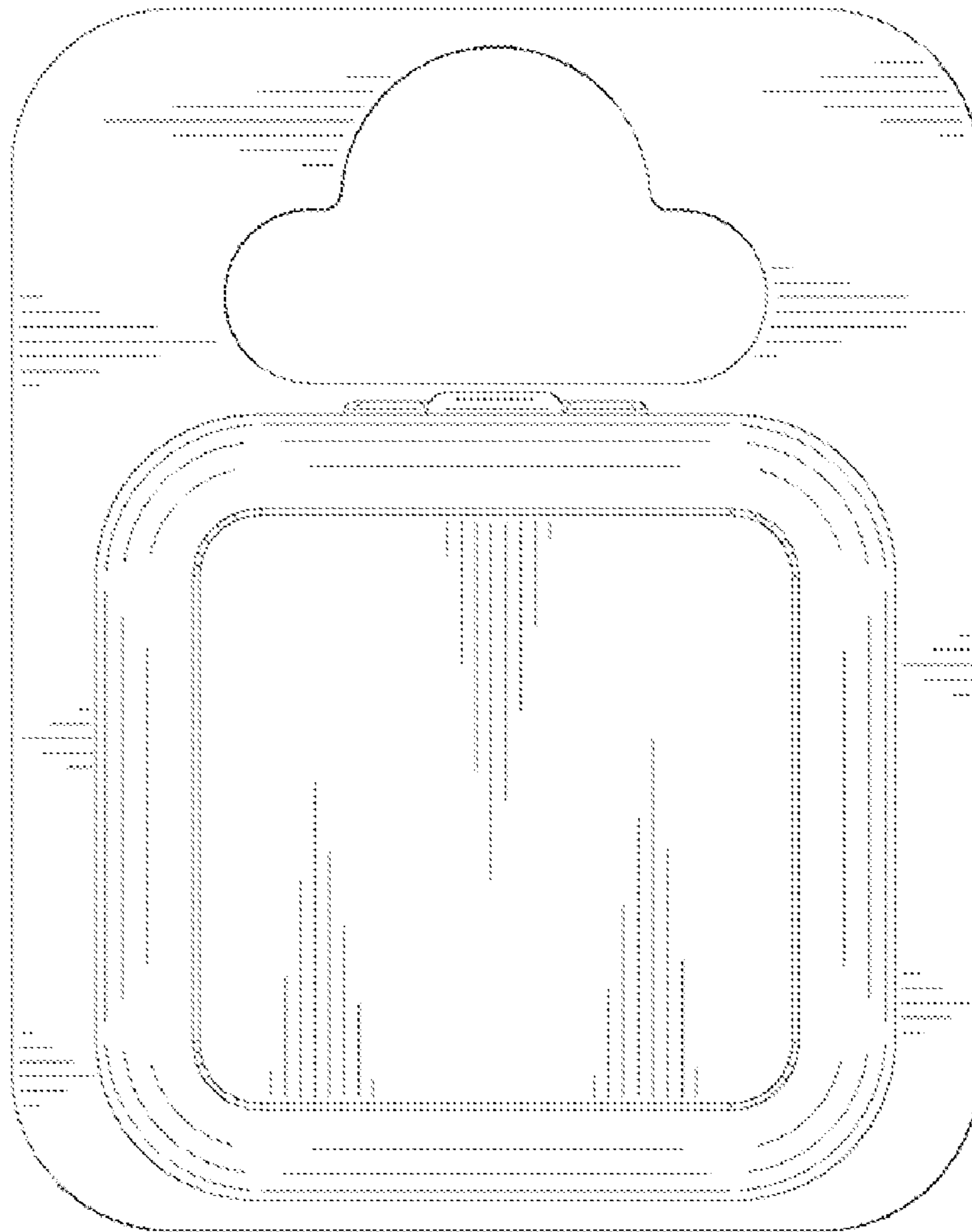

FIG. 3

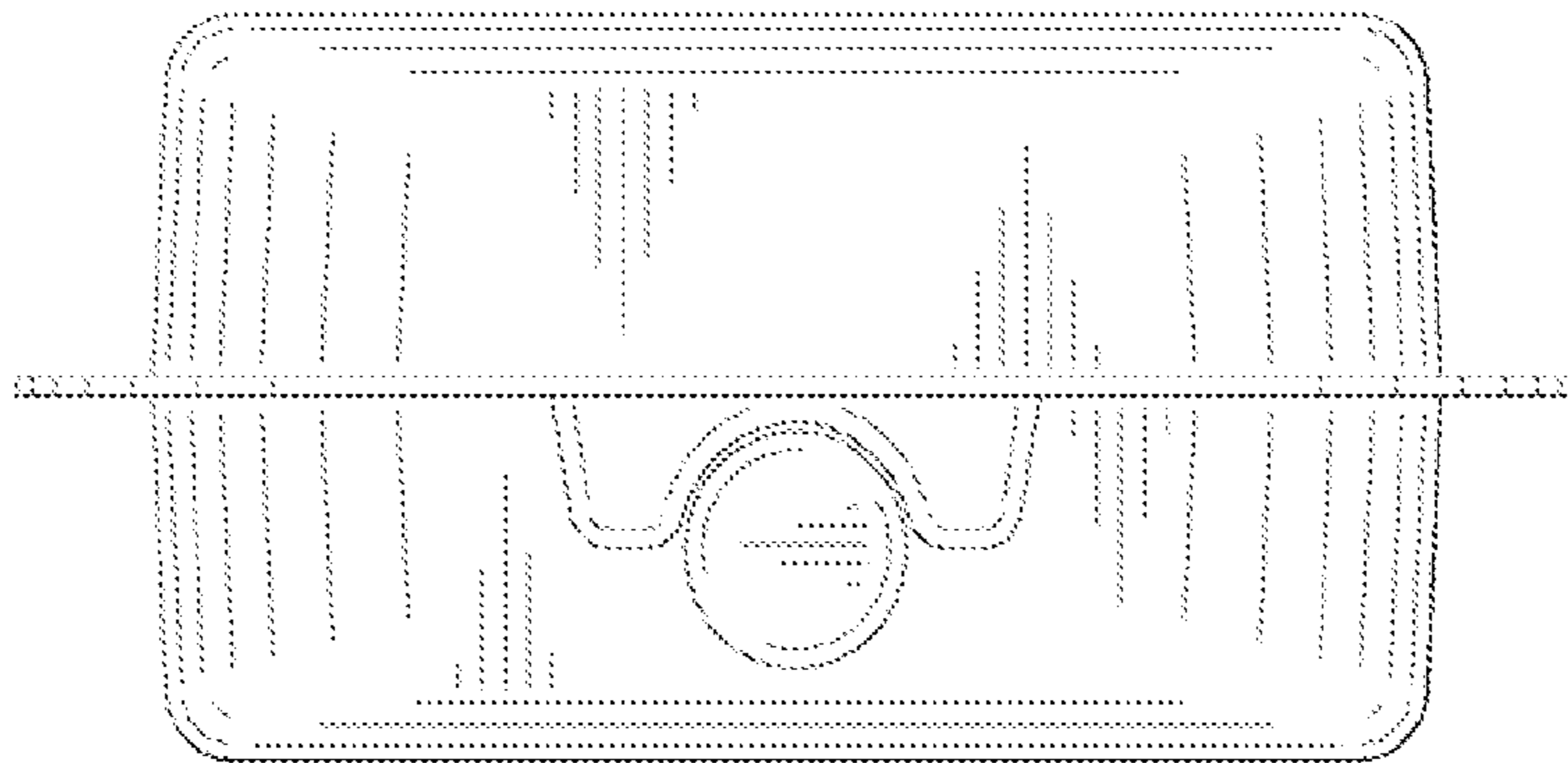

FIG. 4

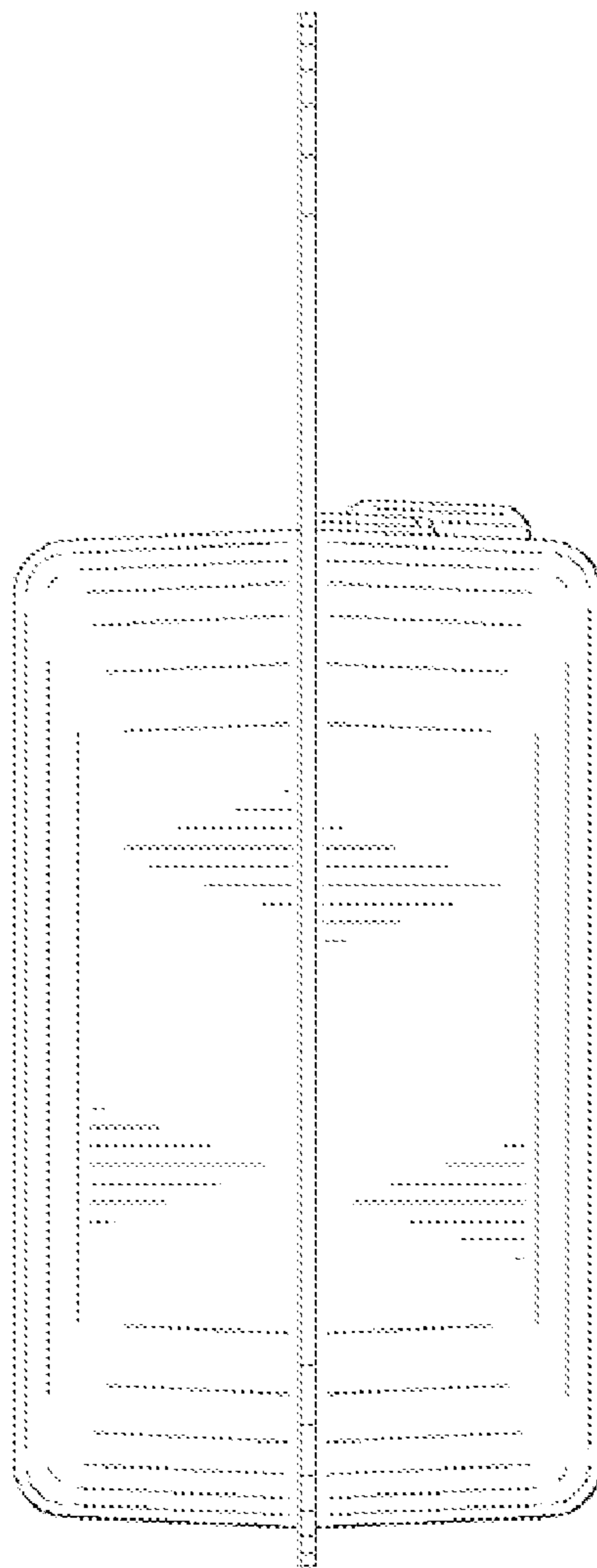

FIG. 5

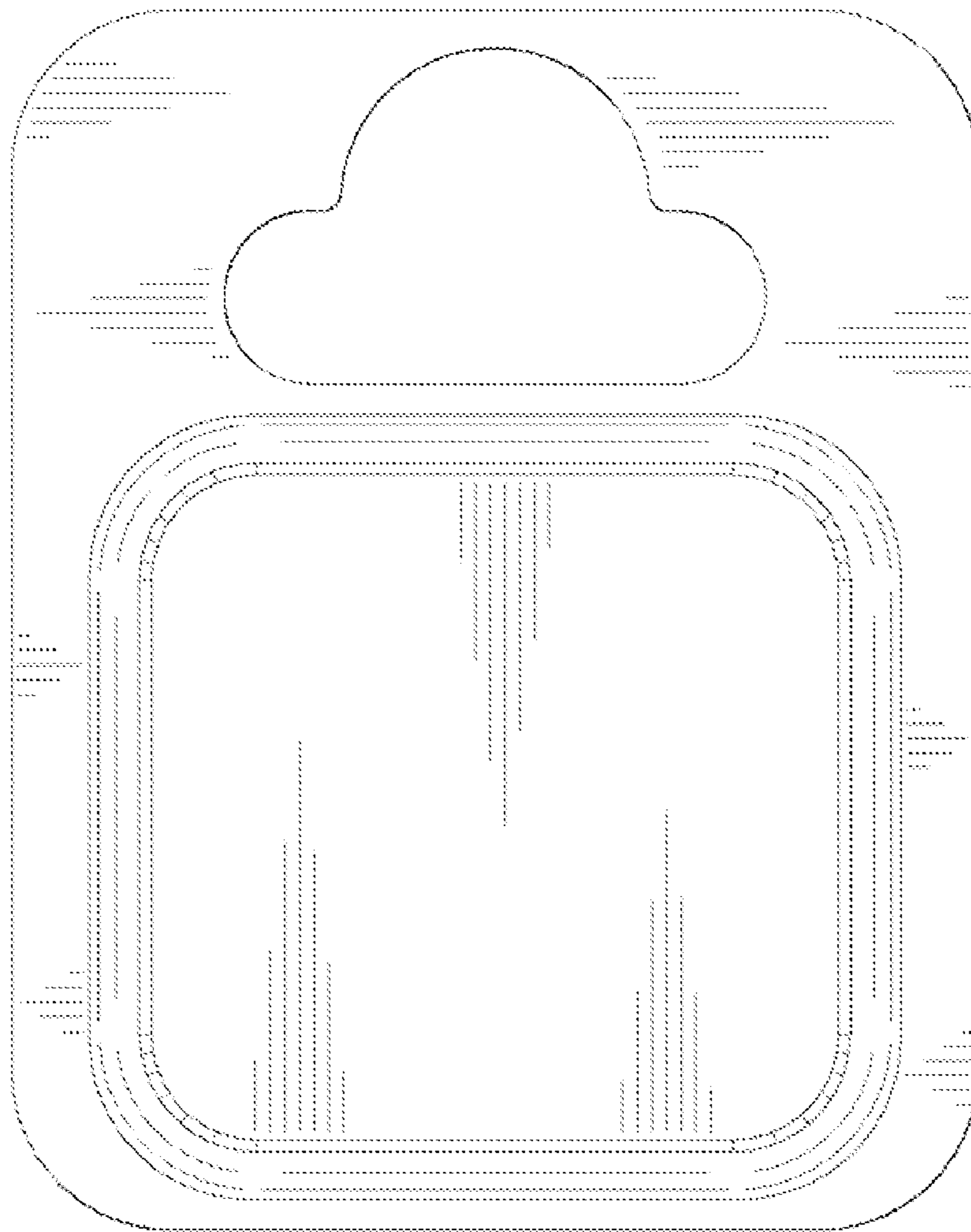

FIG. 6

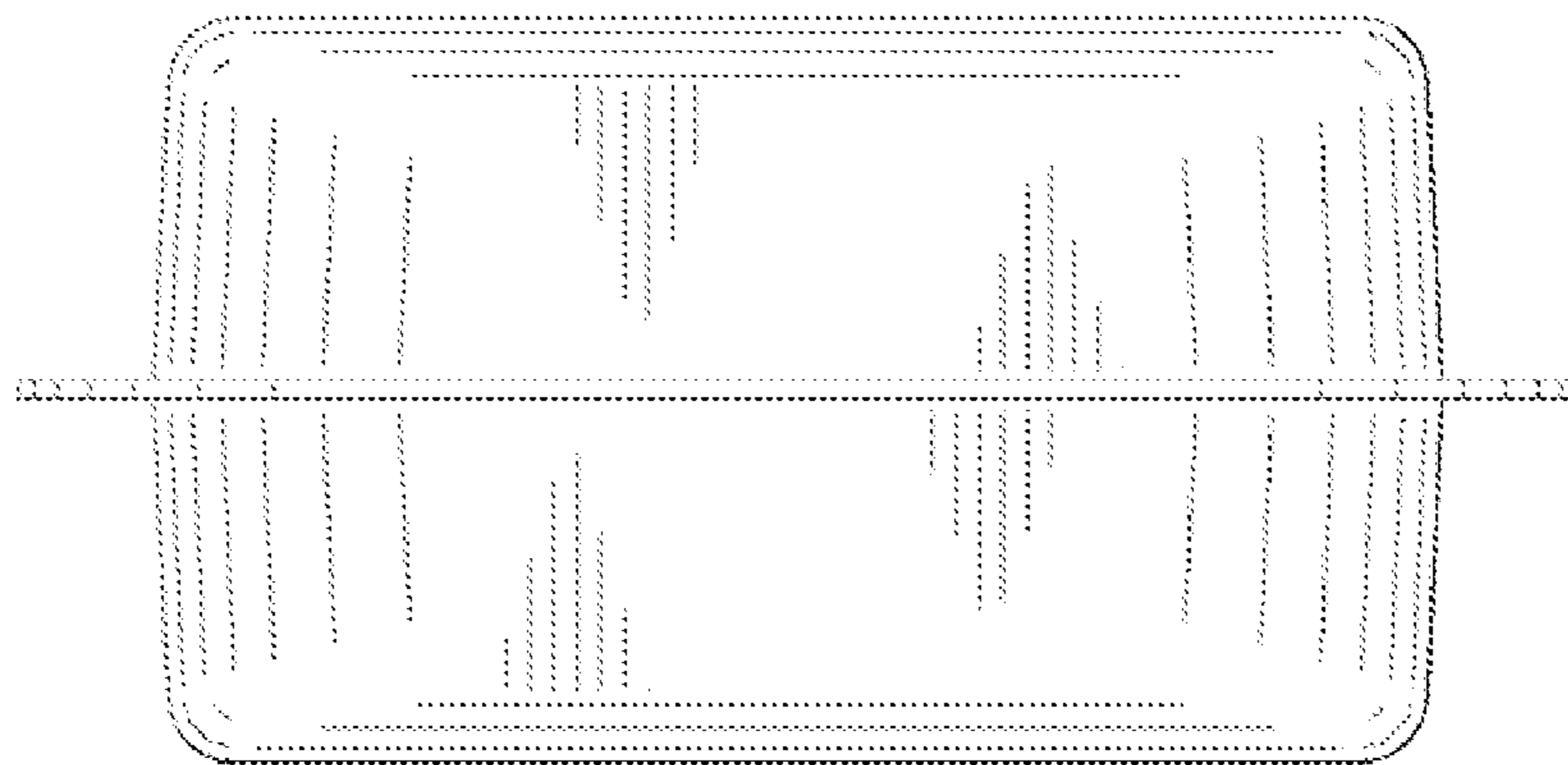

FIG. 7

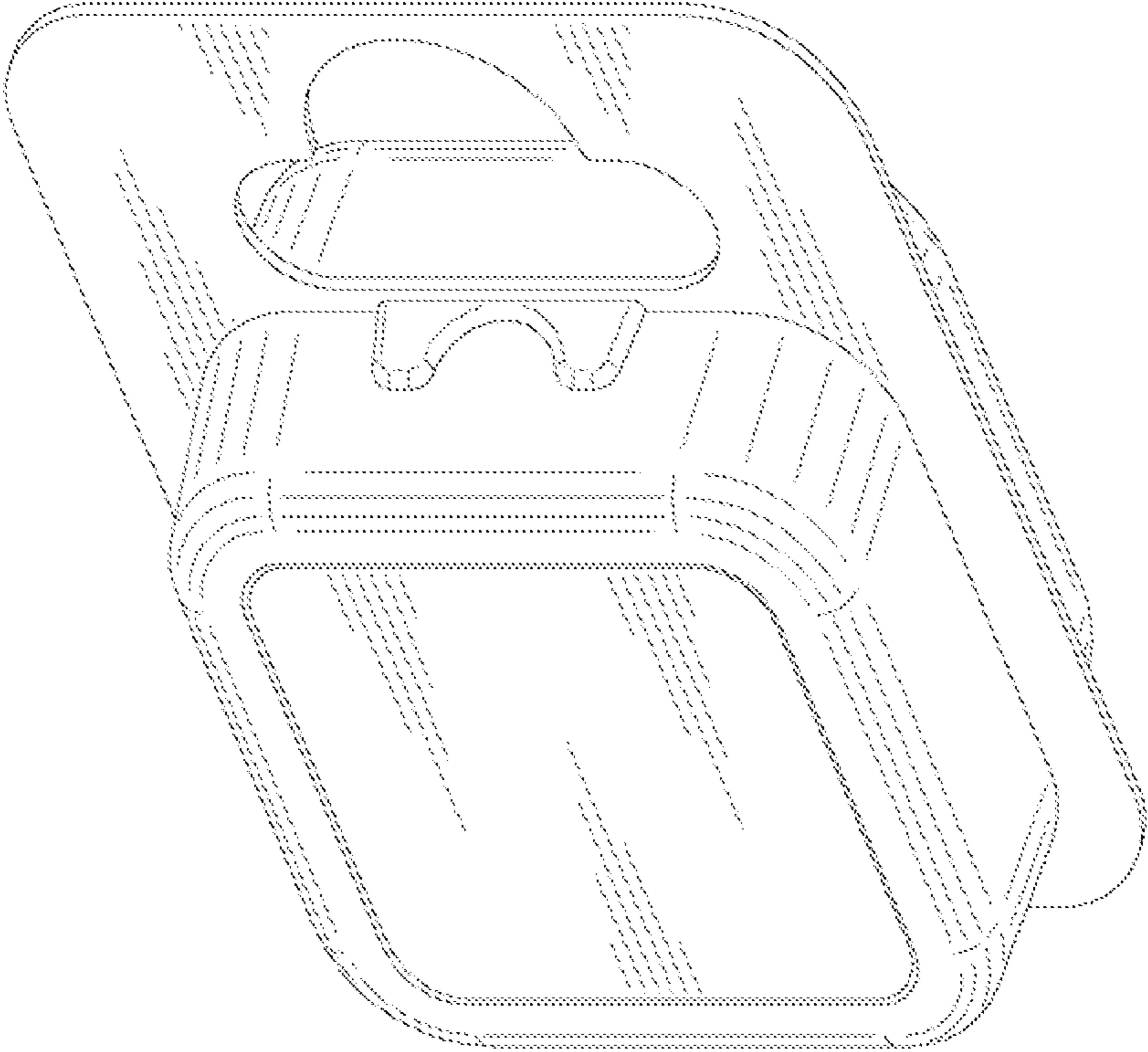

FIG. 8

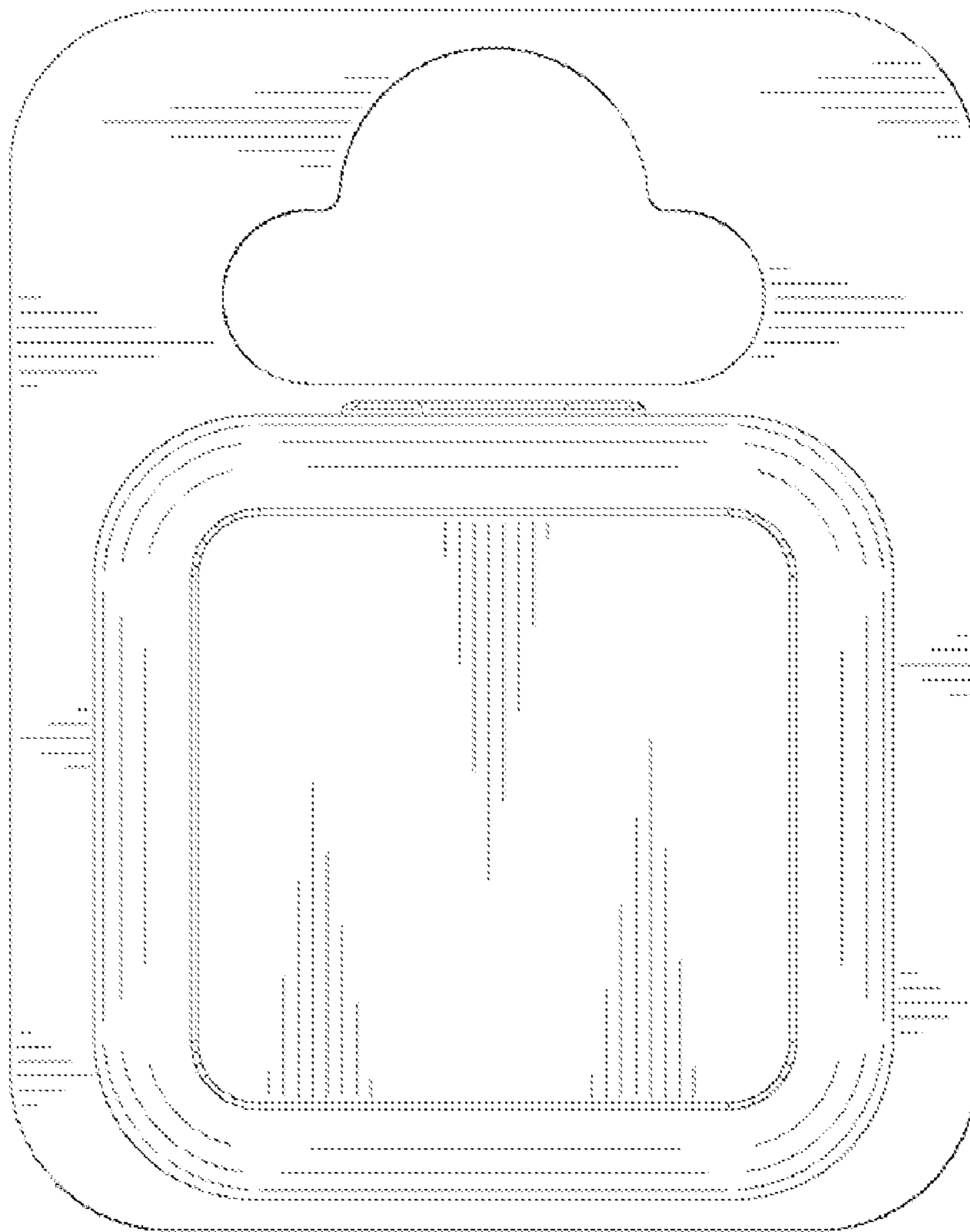

FIG. 9

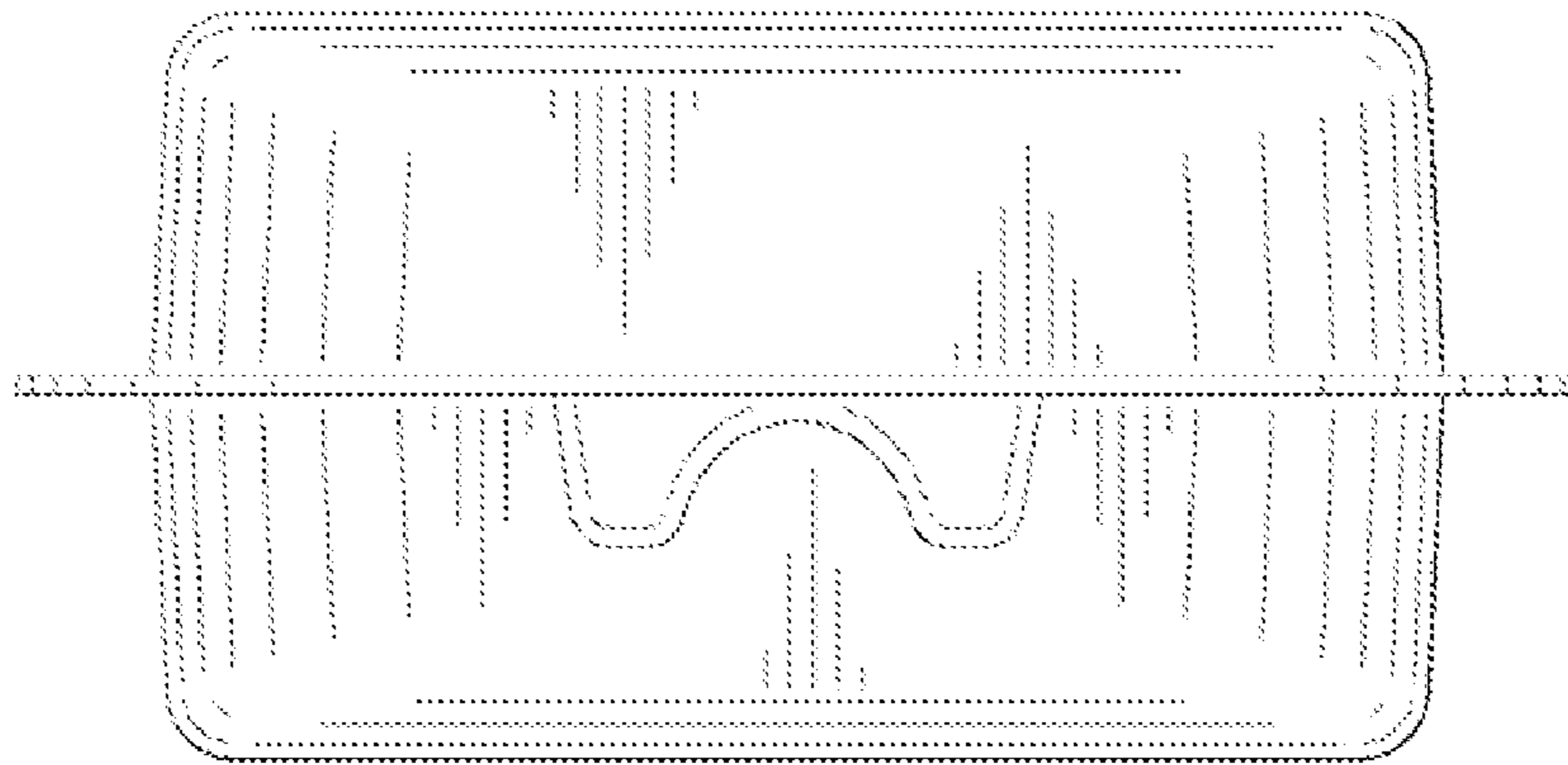

FIG. 10

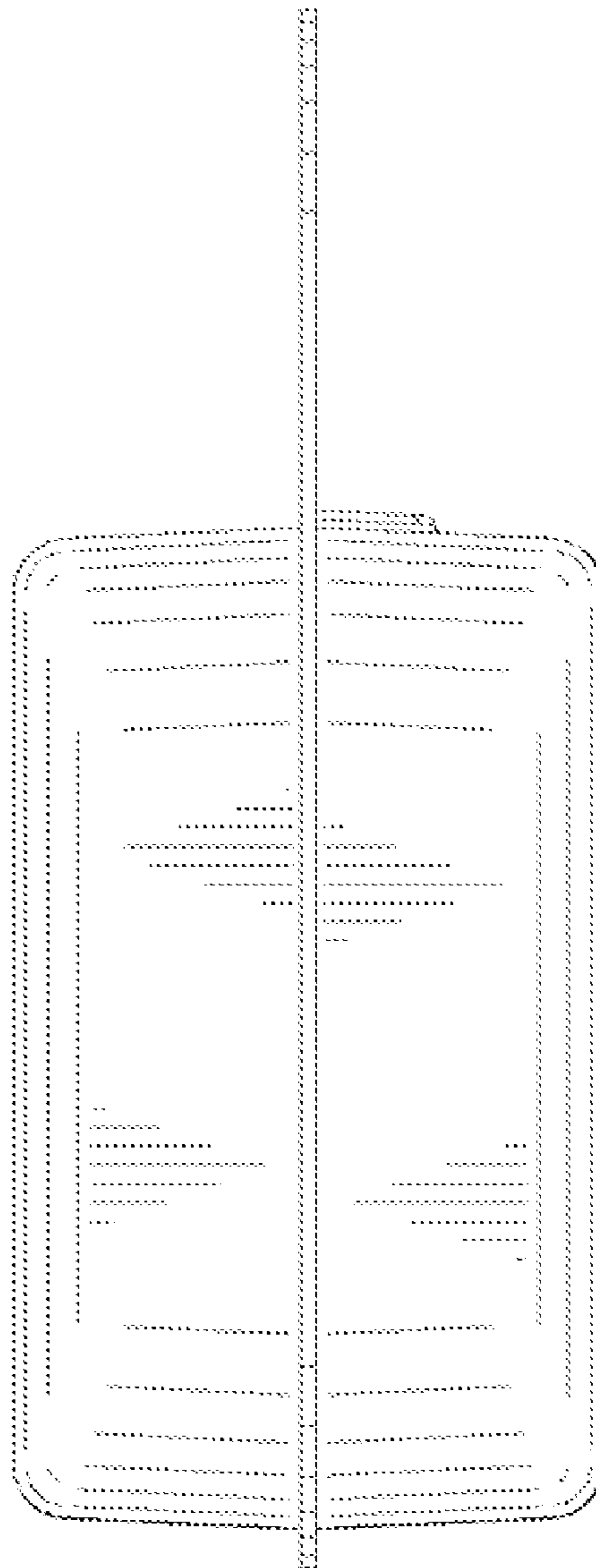

FIG. 11

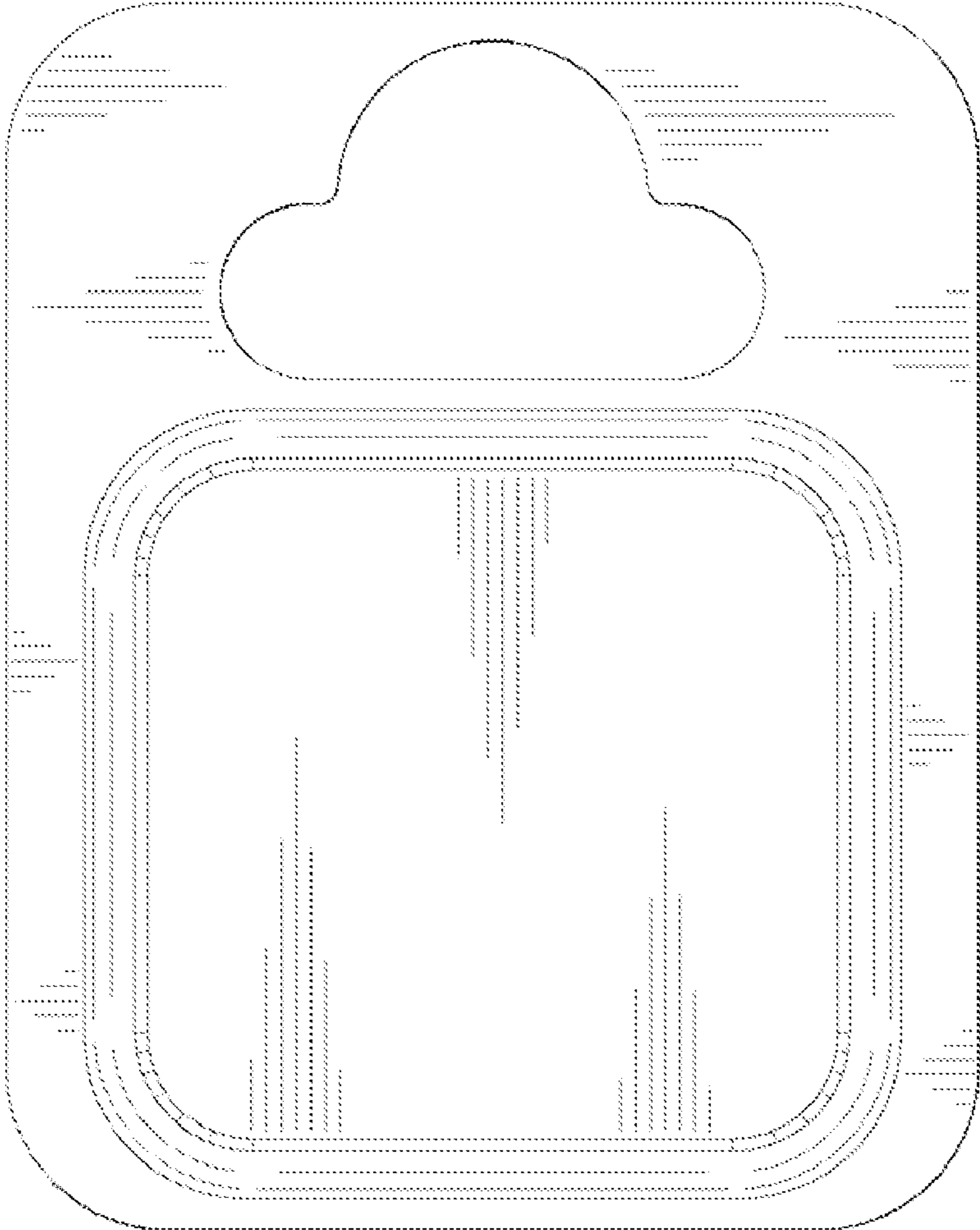

FIG. 12

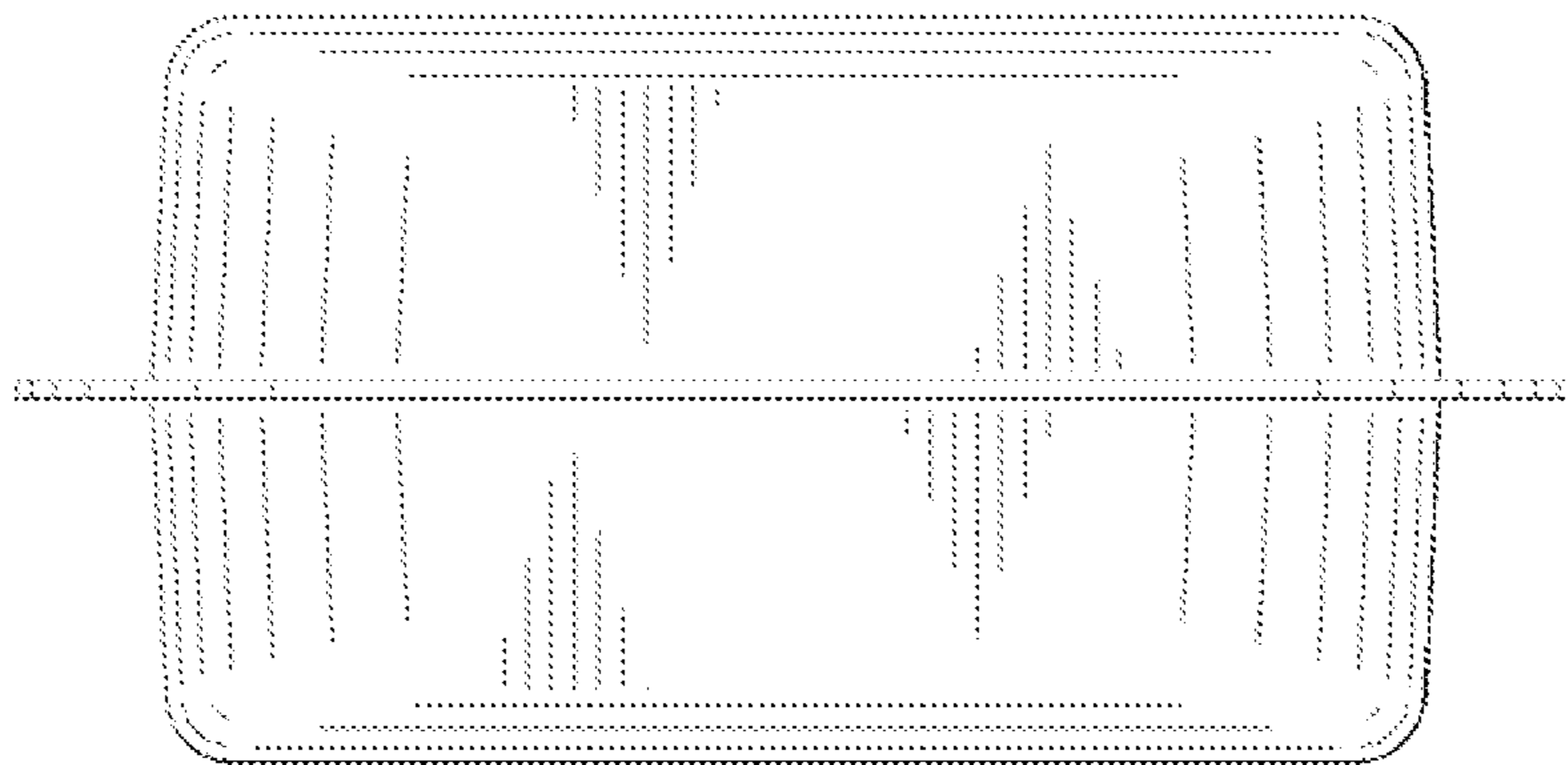

FIG. 13

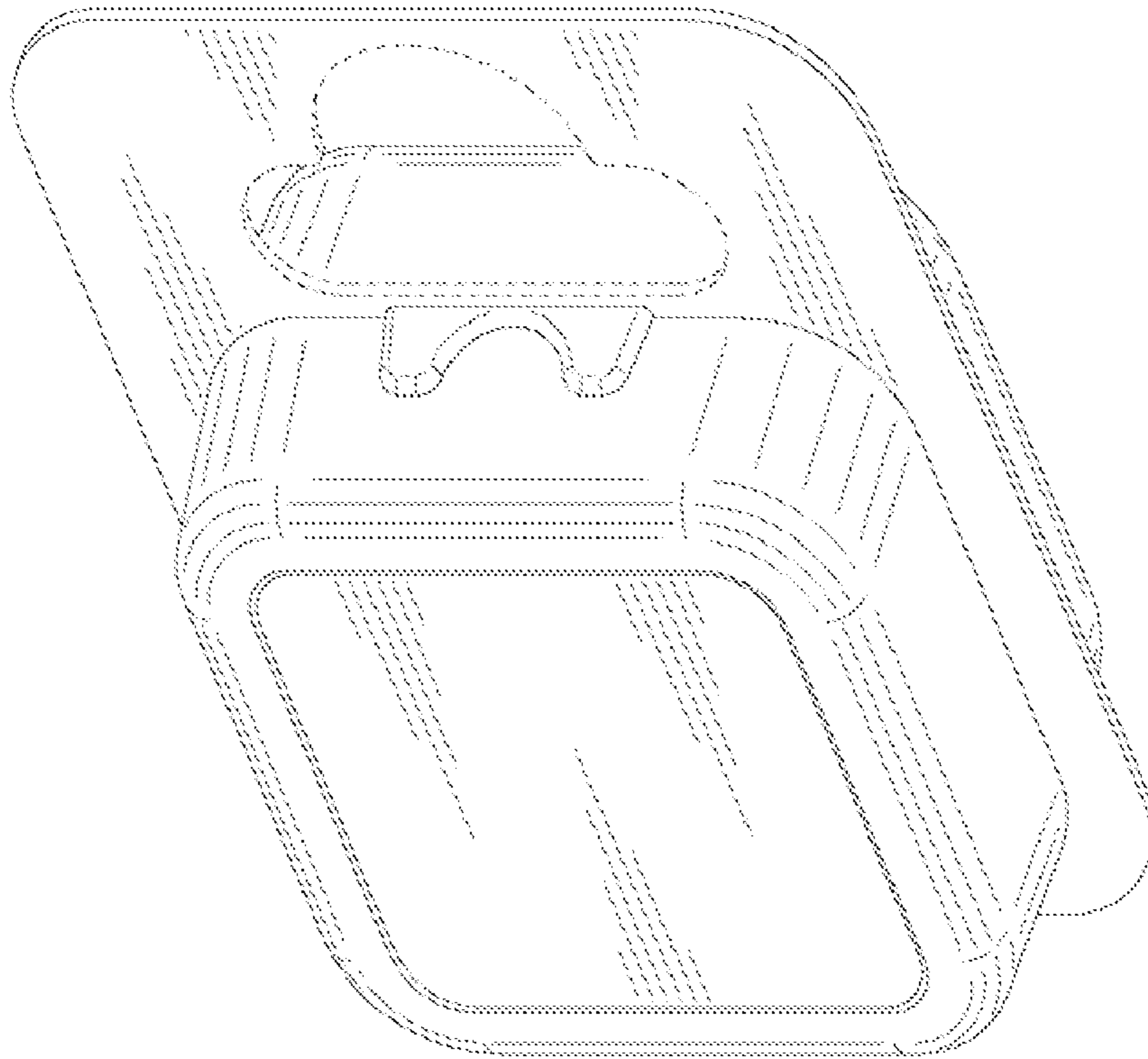

FIG. 14

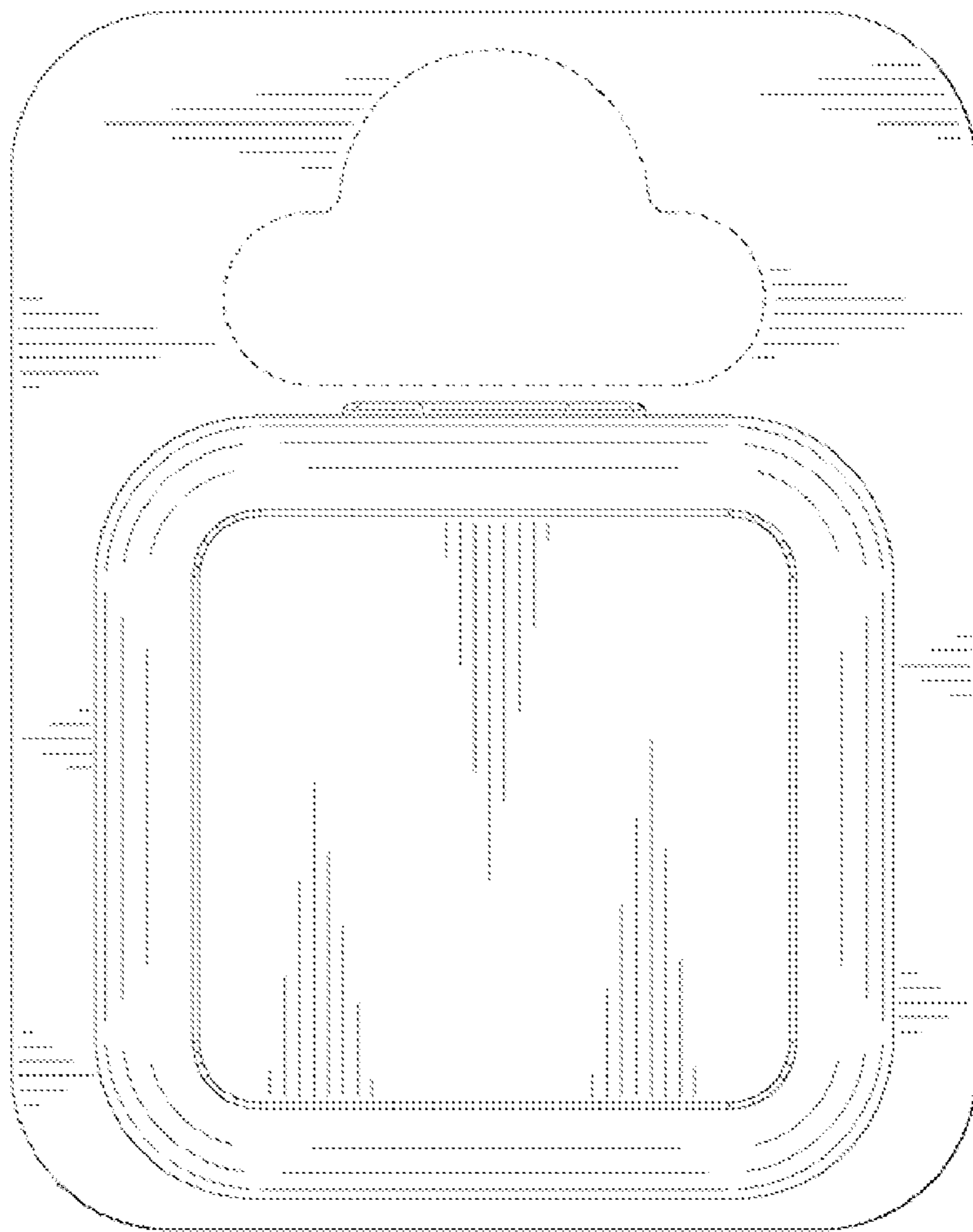

FIG. 15

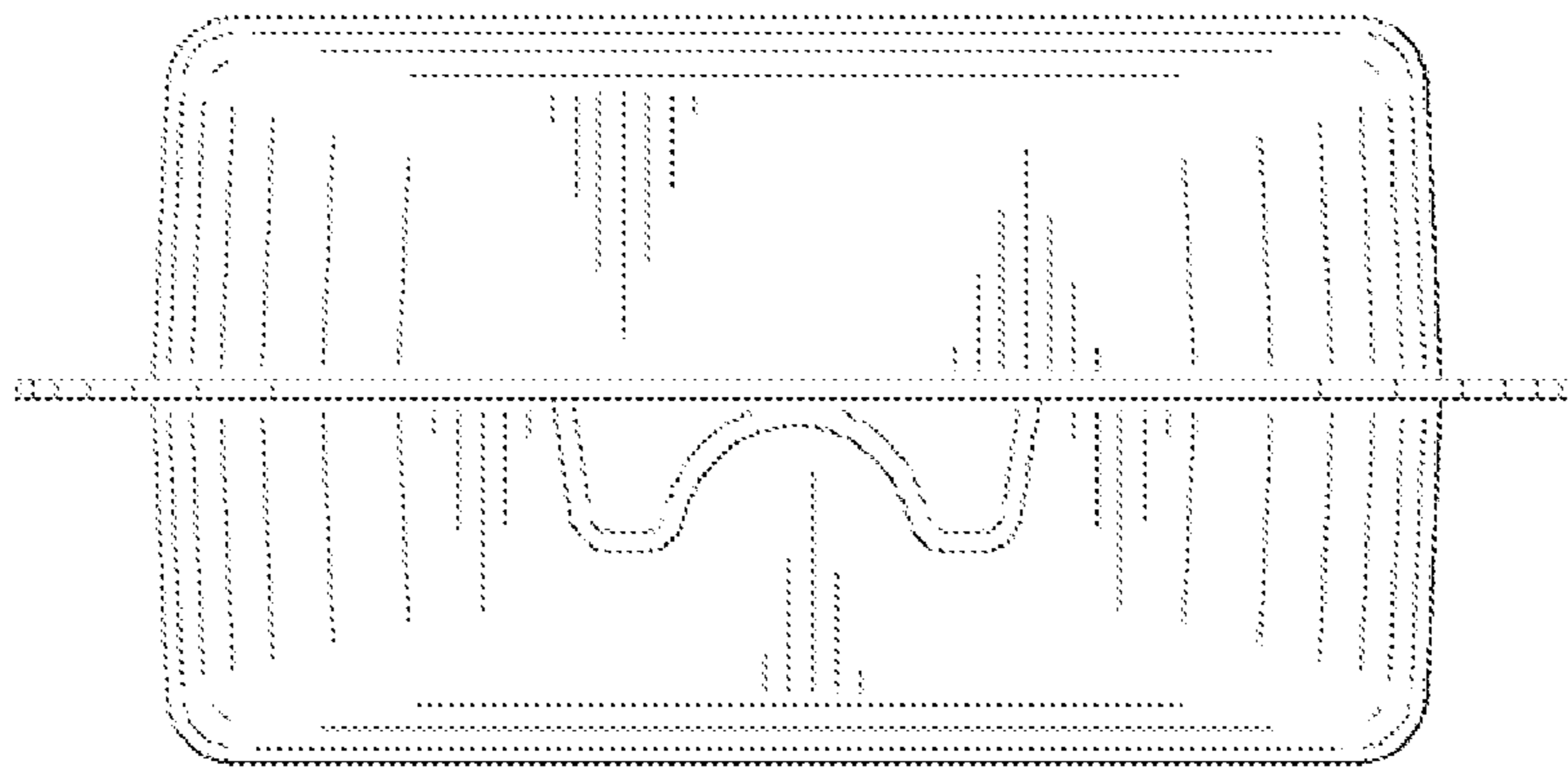

FIG. 16

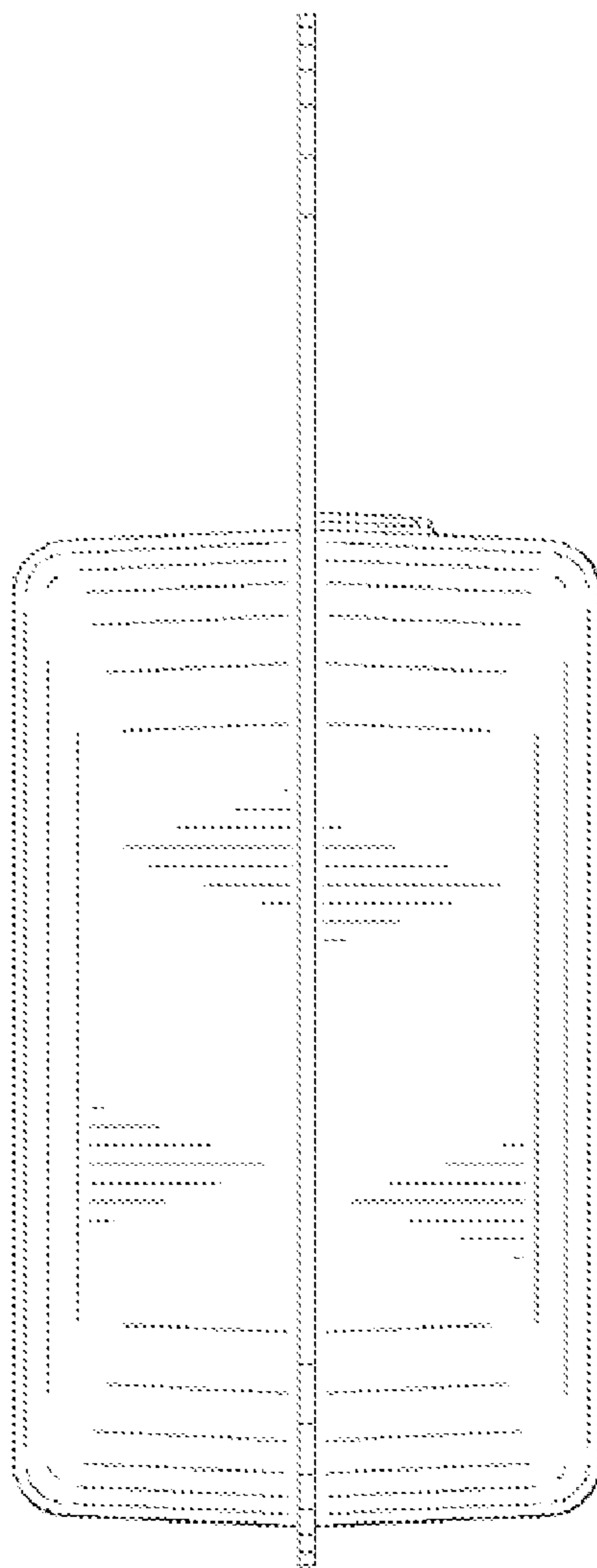

FIG. 17

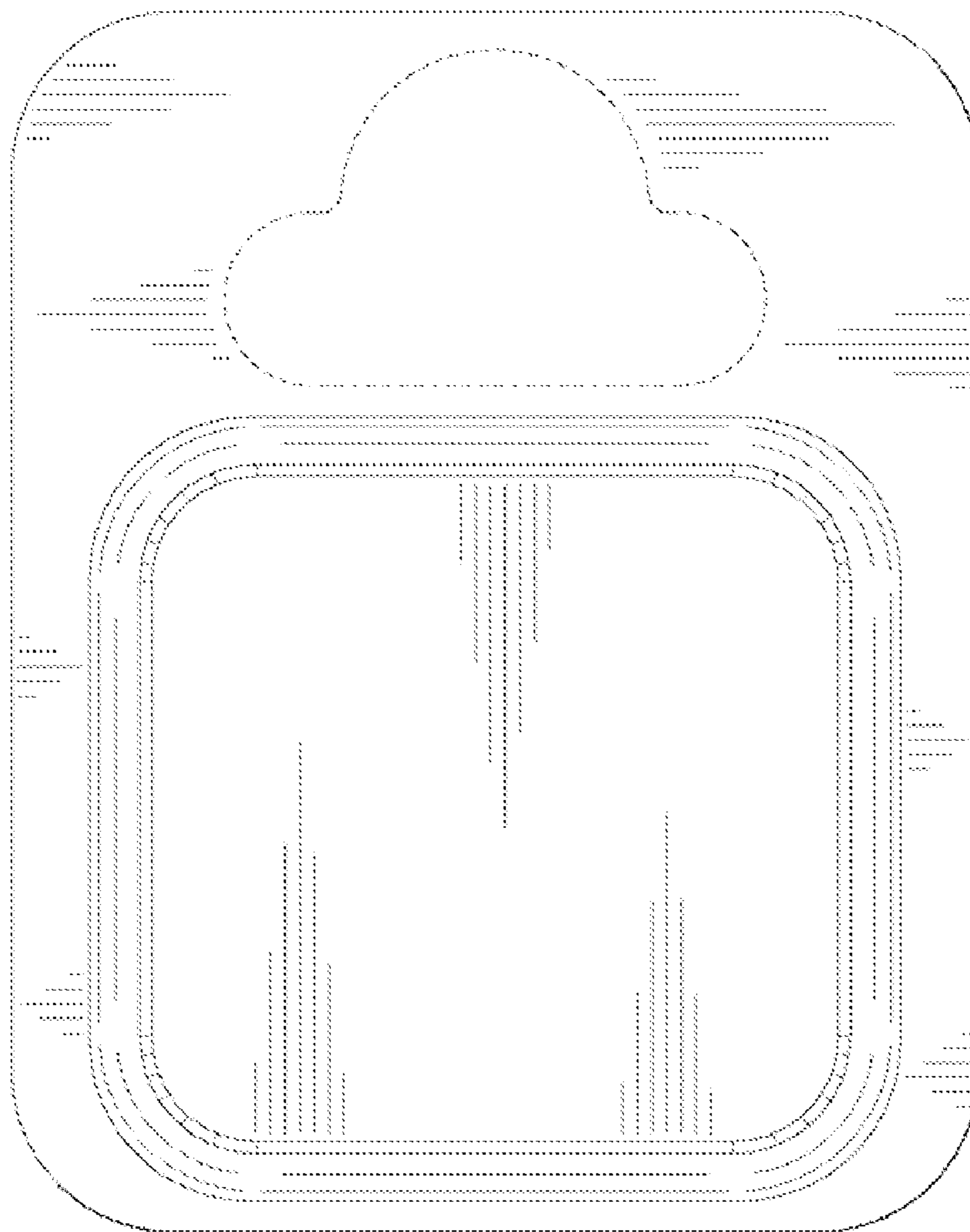
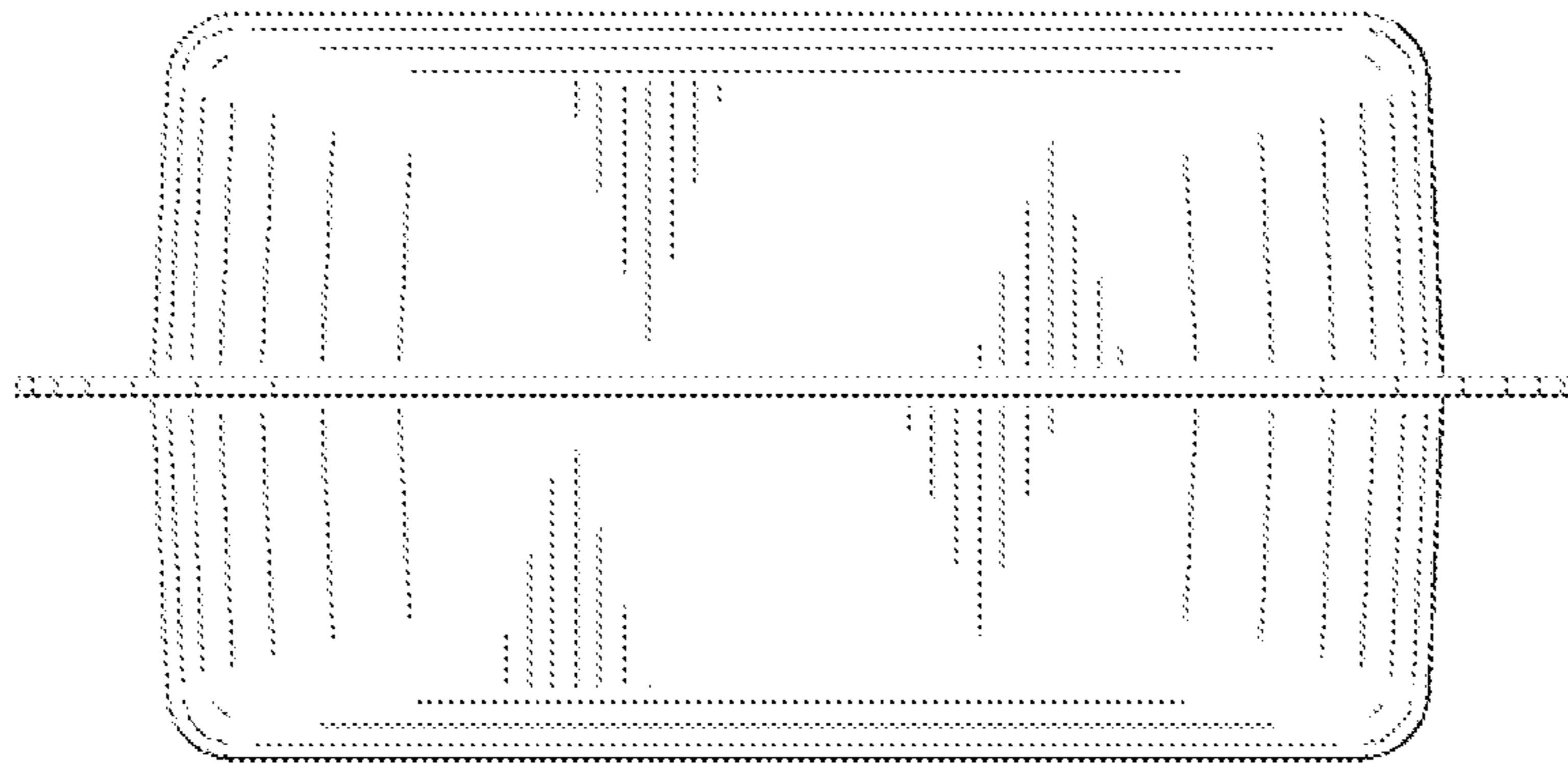

FIG. 18



UNITED STATES PATENT AND TRADEMARK OFFICE
CERTIFICATE OF CORRECTION

PATENT NO. : D632,955 S
APPLICATION NO. : 29/362400
DATED : February 22, 2011
INVENTOR(S) : George W. Smith, III et al.

Page 1 of 20

It is certified that error appears in the above-identified patent and that said Letters Patent is hereby corrected as shown below:

Delete the Title Page and substitute therefore the attached Title Page showing the corrected illustrative figures.

IN THE DRAWINGS:

Replace Drawing Sheets 1 to 18, consisting of Figures 1 to 18, with the Replacement Sheets attached hereto, consisting of Figures 1 to 18.

Signed and Sealed this
Twenty-fourth Day of May, 2011

A handwritten signature in black ink that reads "David J. Kappos". The signature is written in a cursive style with a large initial "D" and "K".

David J. Kappos
Director of the United States Patent and Trademark Office

(12) **United States Design Patent**
Smith, III et al.

(10) **Patent No.:** **US D632,955 S**
(45) **Date of Patent:** **** Feb. 22, 2011**

(54) **CLAMSHELL PACKAGE**

(75) Inventors: **George W. Smith, III**, Barrington, IL (US); **Mark W. Sprenger**, Elk Grove Villiage, IL (US)

(73) Assignee: **Interactive Vending Corporation**, Barrington, IL (US)

(**) Term: **14 Years**

(21) Appl. No.: **29/362,400**

(22) Filed: **May 25, 2010**

(51) **LOC (9) Cl.** **09-03**

(52) **U.S. Cl.** **D9/415**

(58) **Field of Classification Search** D9/414-435, D9/456, 457, 499, 715, 720-722; 206/461-471, 206/806, 815

See application file for complete search history.

(56) **References Cited**

U.S. PATENT DOCUMENTS

3,251,390	A *	5/1966	Evans	383/17
D209,867	S *	1/1968	Sigoloff	D9/418
D257,585	S *	12/1980	Neuwirth	D9/425
D268,331	S *	3/1983	Kay et al.	D9/415
4,496,052	A *	1/1985	Nertman	206/470
4,570,818	A *	2/1986	Borst et al.	220/835
4,687,129	A *	8/1987	Cugley	220/315
4,694,960	A *	9/1987	Phipps et al.	206/469
4,771,934	A *	9/1988	Kalmanides	229/406
D305,408	S	1/1990	Lafoie	
D306,561	S	3/1990	Lee	
D329,600	S	9/1992	Lafoie	
5,291,995	A *	3/1994	von Agris et al.	206/336
D393,799	S *	4/1998	Pope et al.	D9/415
D401,765	S *	12/1998	Soutullo	D4/199

(Continued)

Primary Examiner Catherine Tuttle
(74) Attorney, Agent, or Firm—K&L Gates LLP

(57) **CLAIM**

The ornamental design for a clamshell package, as shown and described.

DESCRIPTION

FIG. 1 is a front perspective view showing a first embodiment of our new design for a clamshell package;

FIG. 2 is a front elevational view of FIG. 1;

FIG. 3 is a top plan view of FIG. 1;

FIG. 4 is a right side elevational view of FIG. 1, the left side elevational view being a mirror image thereof;

FIG. 5 is a rear view of FIG. 1;

FIG. 6 is a bottom view of FIG. 1;

FIG. 7 is a front perspective view showing a second embodiment of our new design for a clamshell package;

FIG. 8 is a front elevational view of FIG. 7;

FIG. 9 is a top plan view of FIG. 7;

FIG. 10 is a right side elevational view of FIG. 7, the left side elevational view being a mirror image thereof;

FIG. 11 is a rear view of FIG. 7;

FIG. 12 is a bottom view of FIG. 7;

FIG. 13 is a front perspective view showing a third embodiment of our new design for a clamshell package;

FIG. 14 is a front elevational view of FIG. 13;

FIG. 15 is a top plan view of FIG. 13;

FIG. 16 is a right side elevational view of FIG. 13, the left side elevational view being a mirror image thereof;

FIG. 17 is a rear view of FIG. 13; and,

FIG. 18 is a bottom view of FIG. 13.

The broken lines shown in FIGS. 13, 14 and 17 are included for the purpose of illustrating portions of the clamshell package that form no part of the claim to the third embodiment.

1 Claim, 18 Drawing Sheets

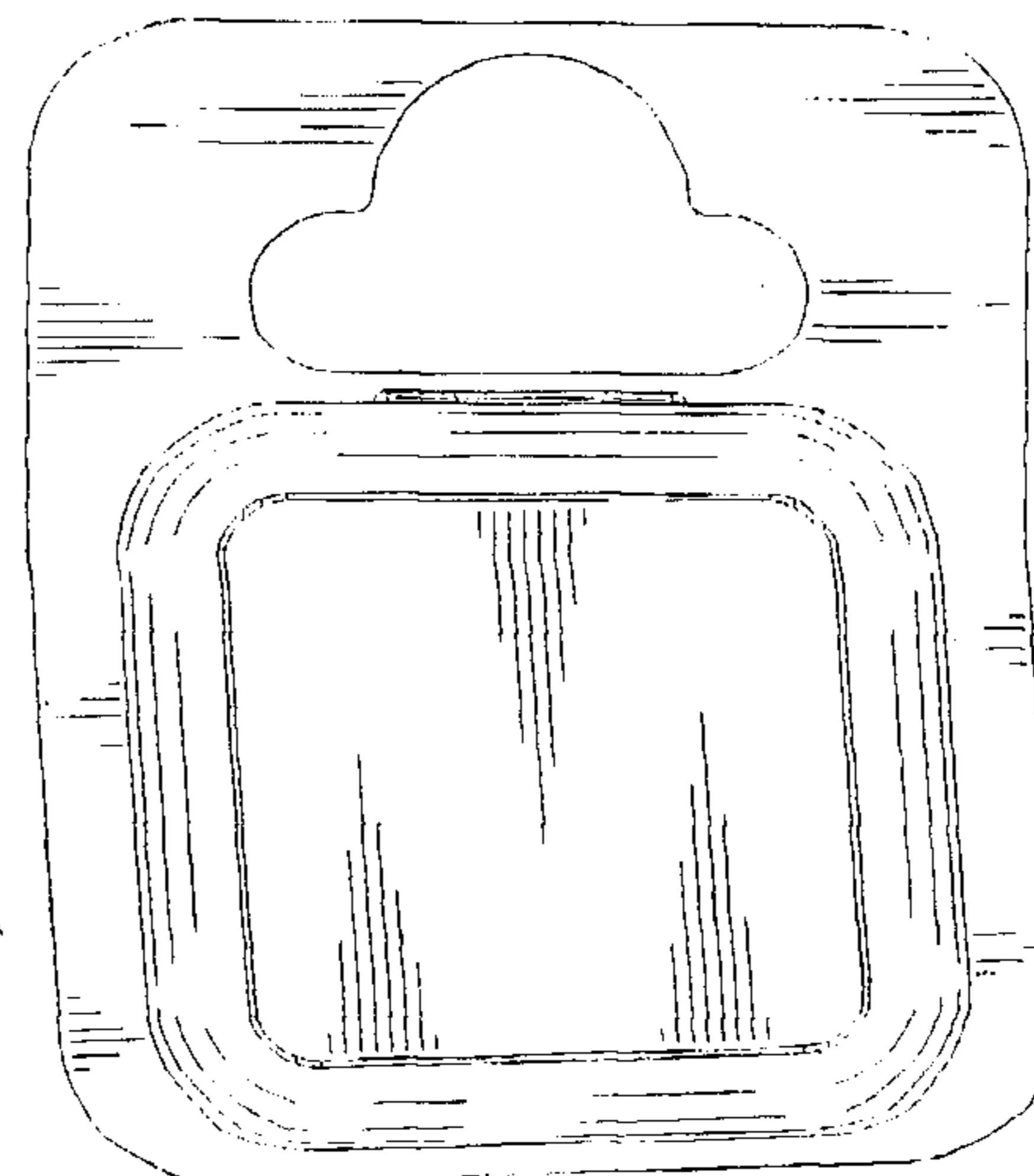
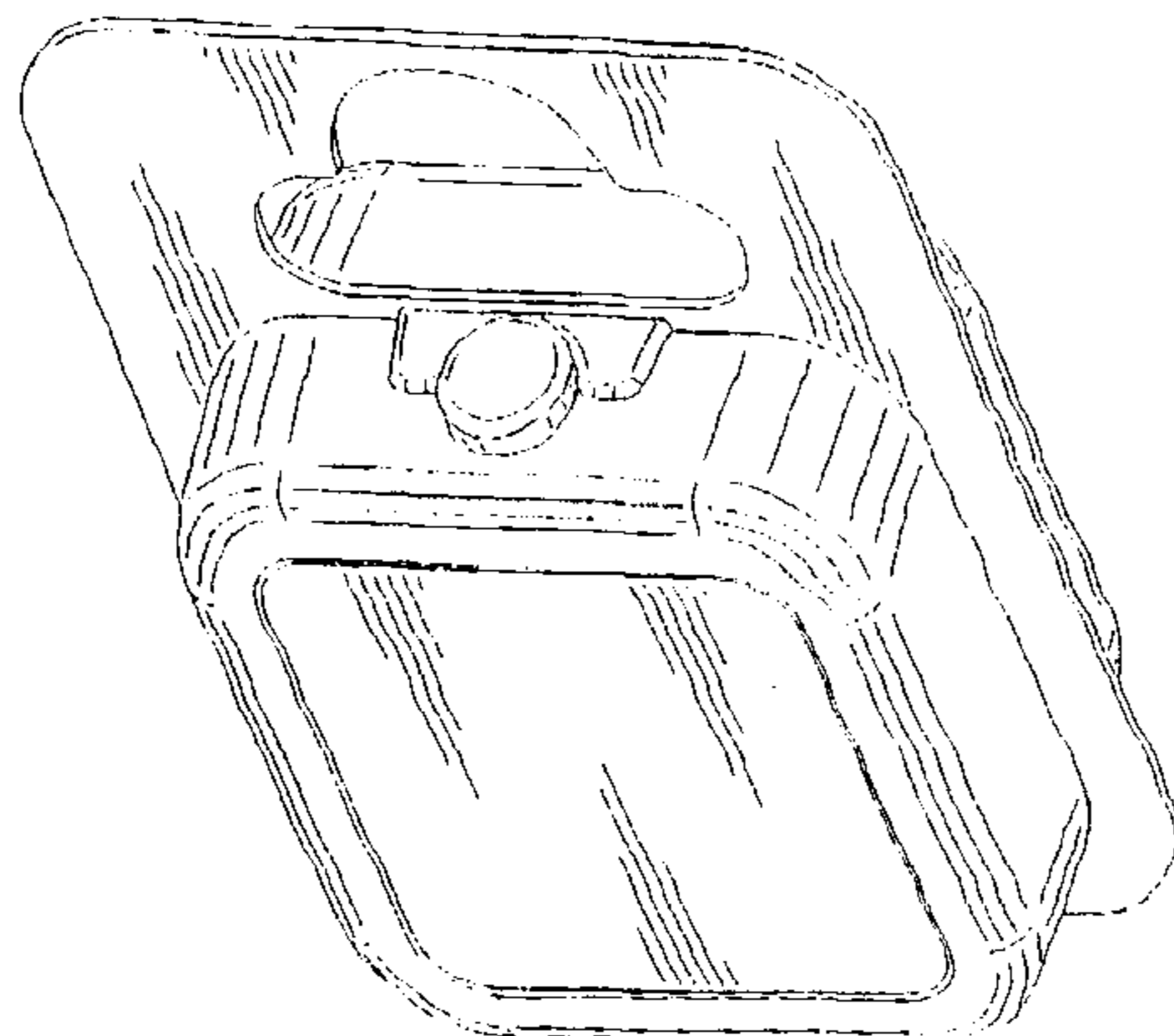

FIG. 1

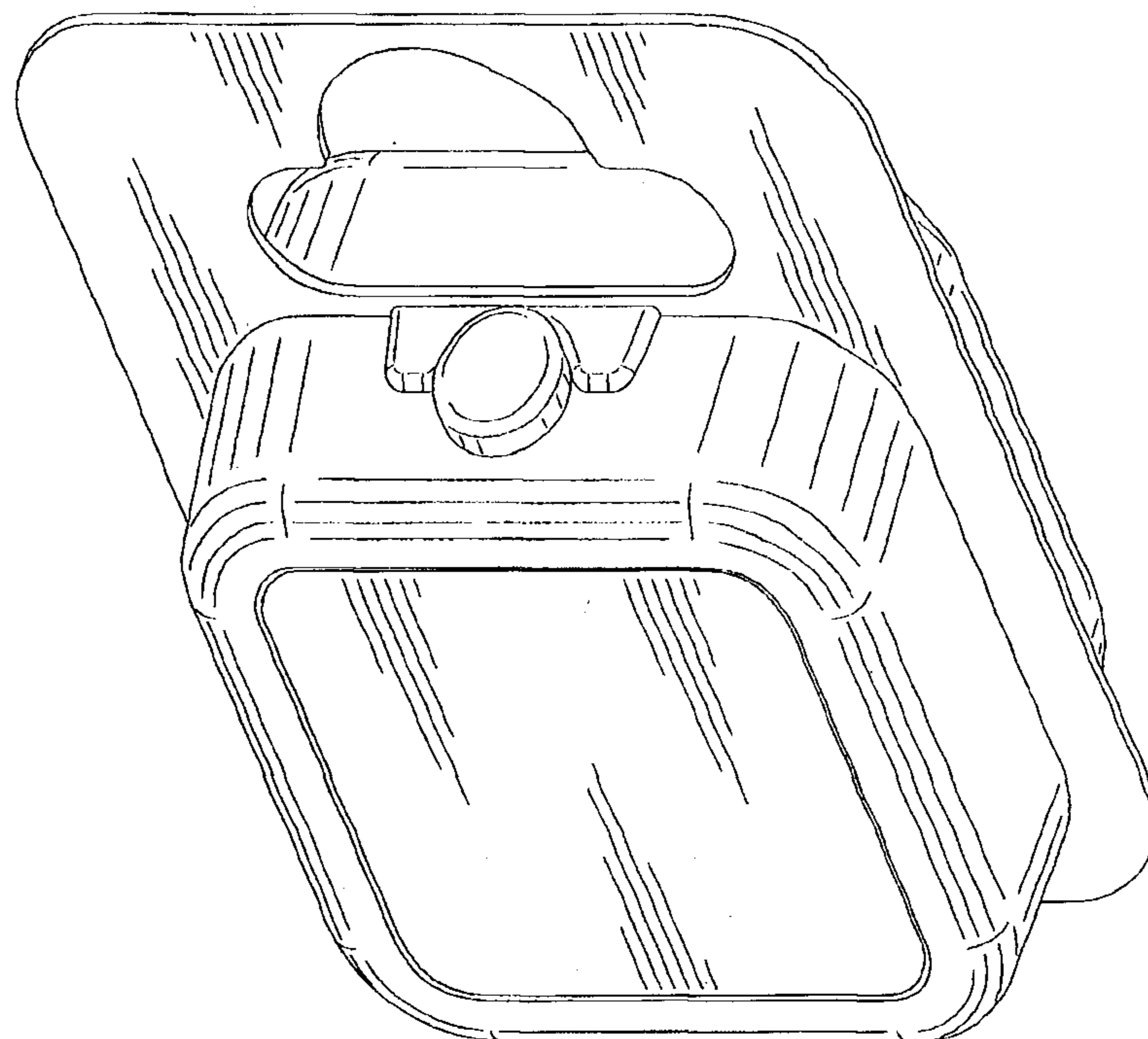

FIG. 2

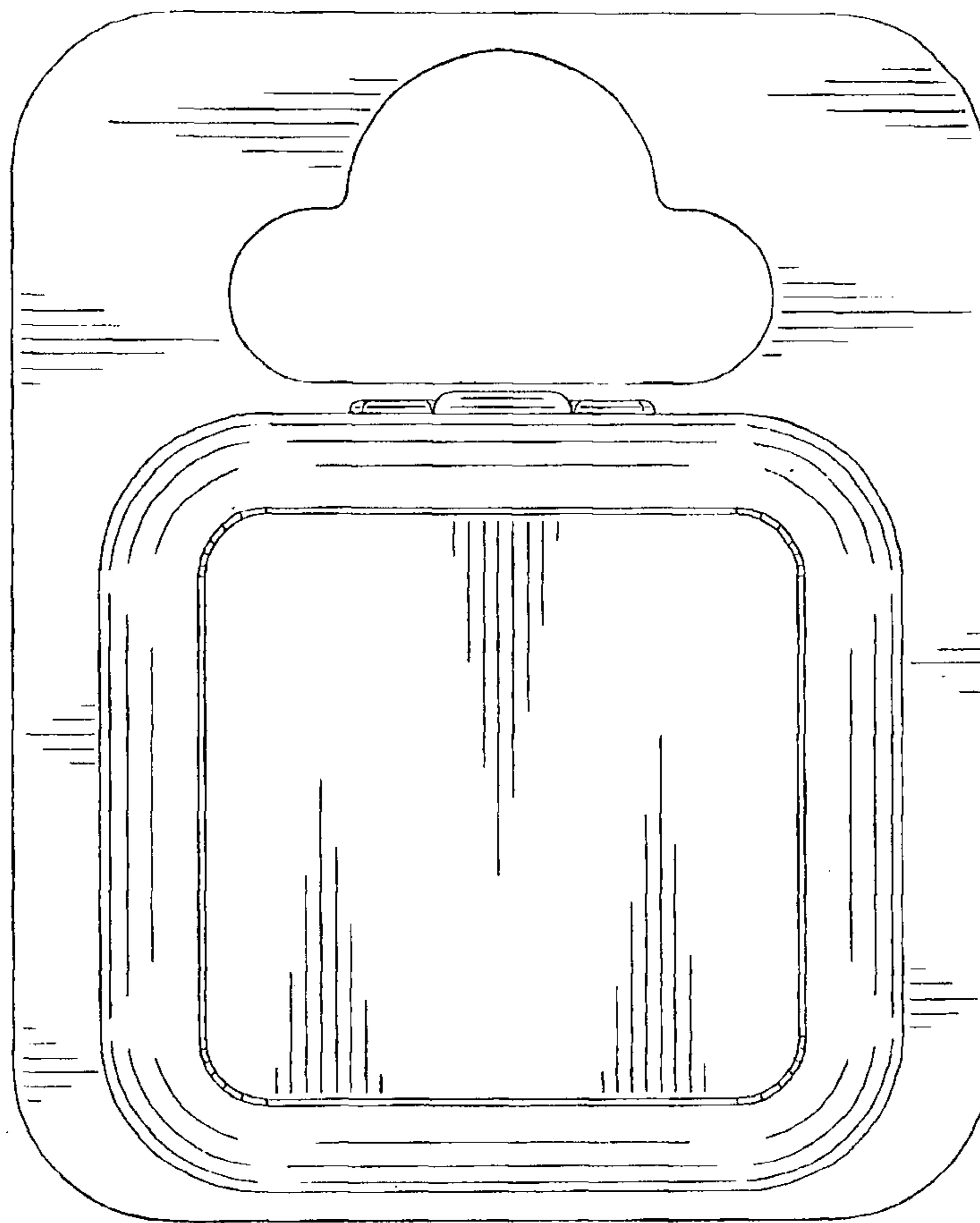

FIG. 3

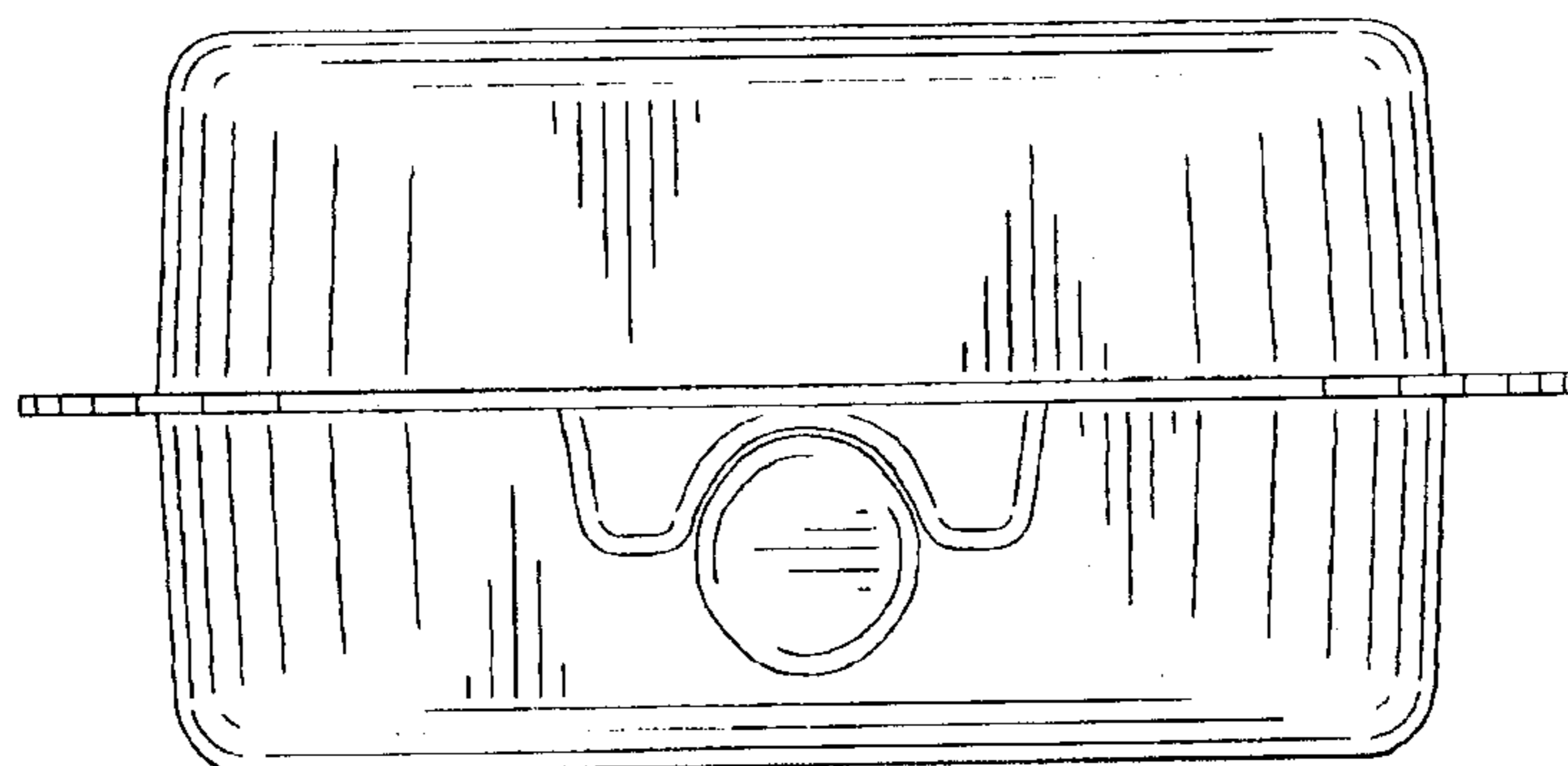

FIG. 4

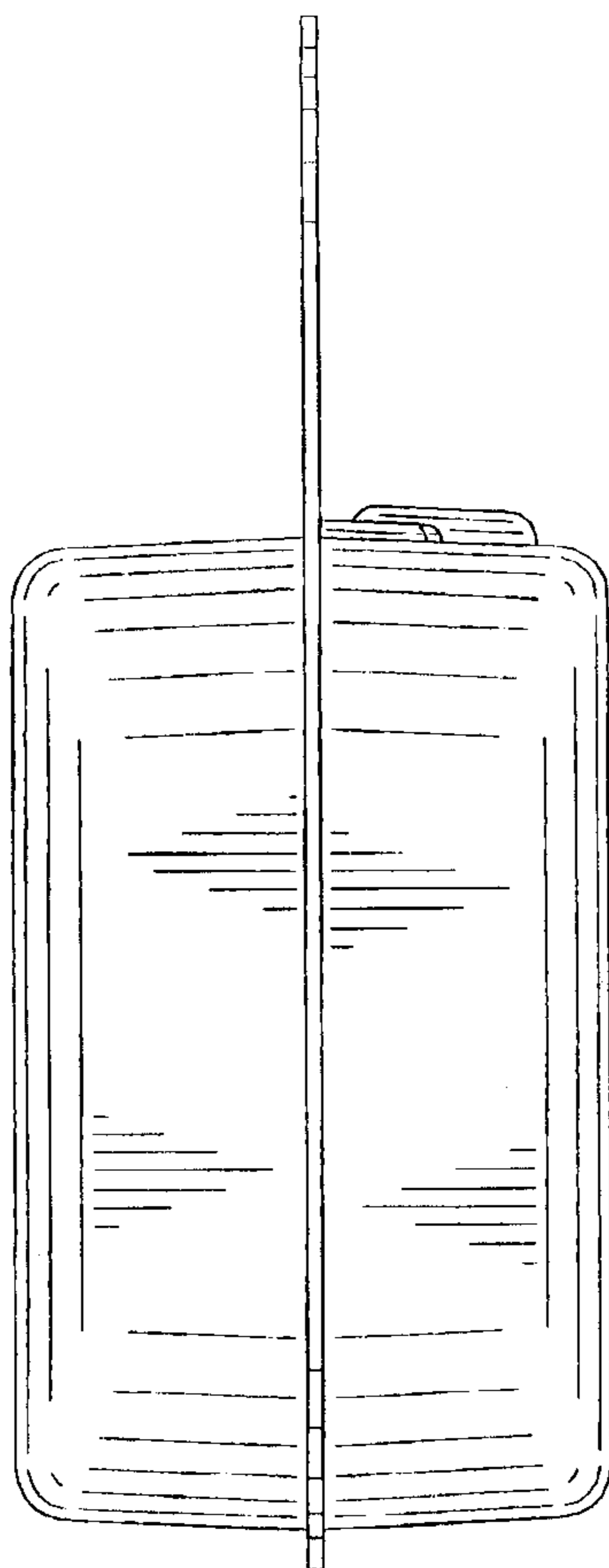

FIG. 5

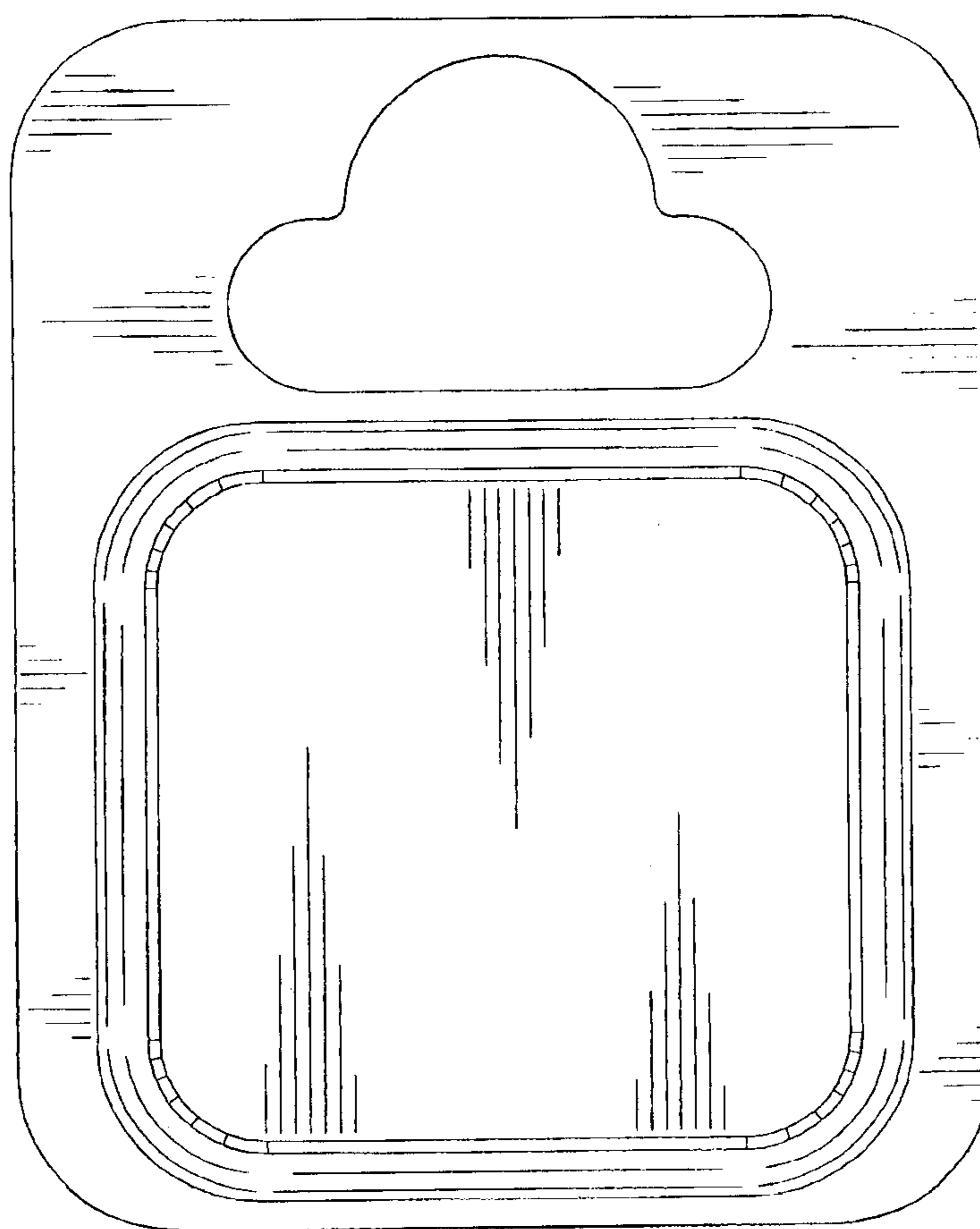

FIG. 6

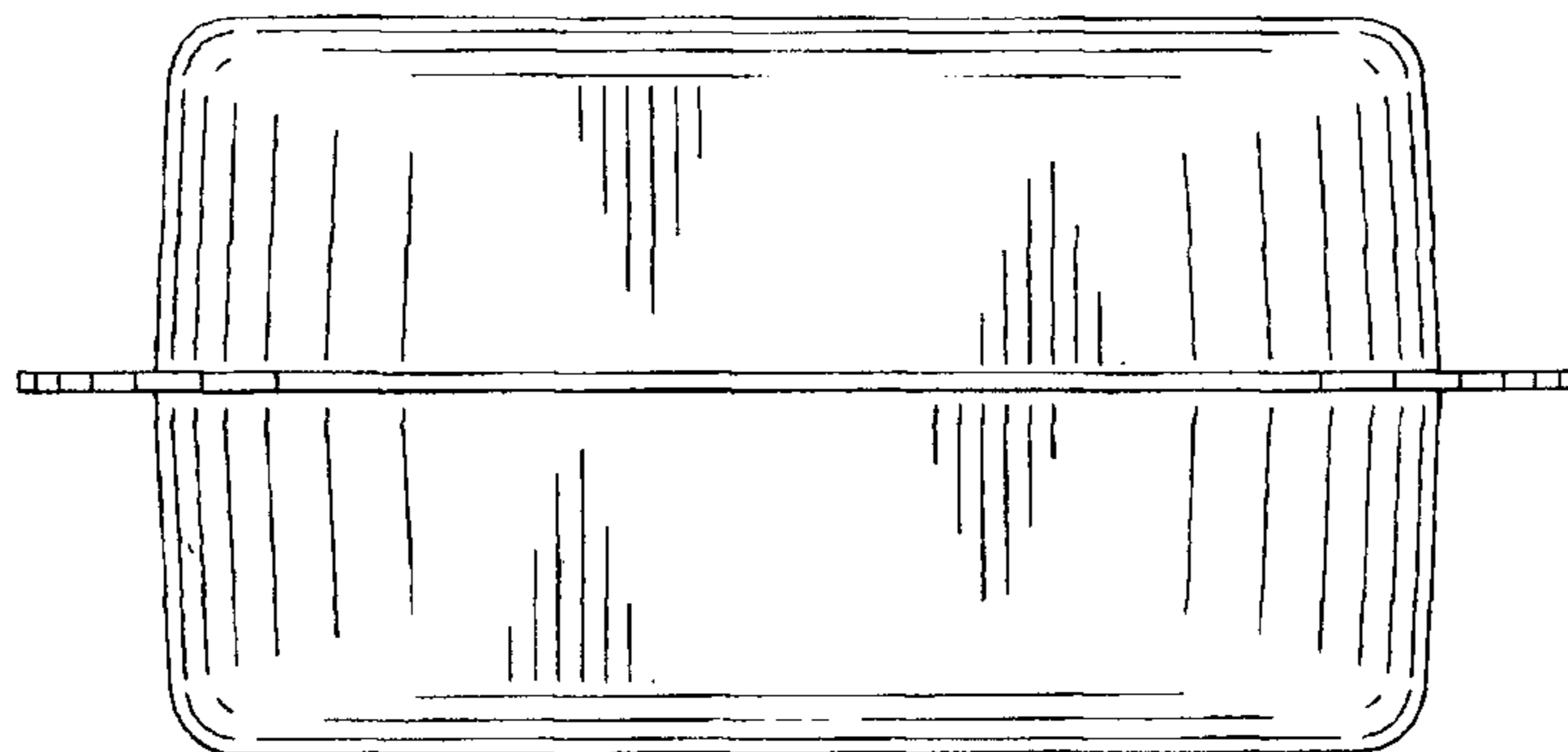

FIG. 7

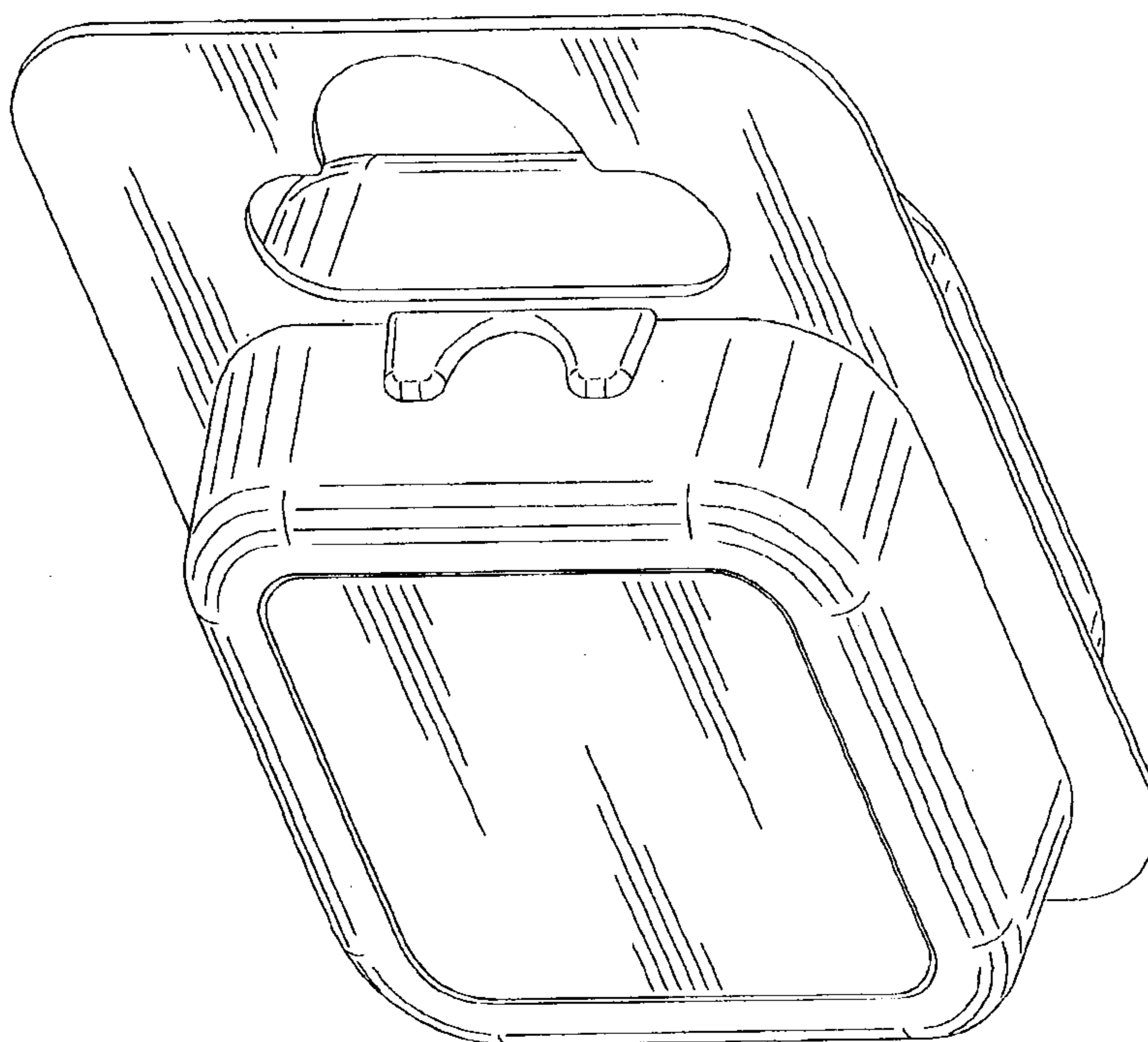

FIG. 8

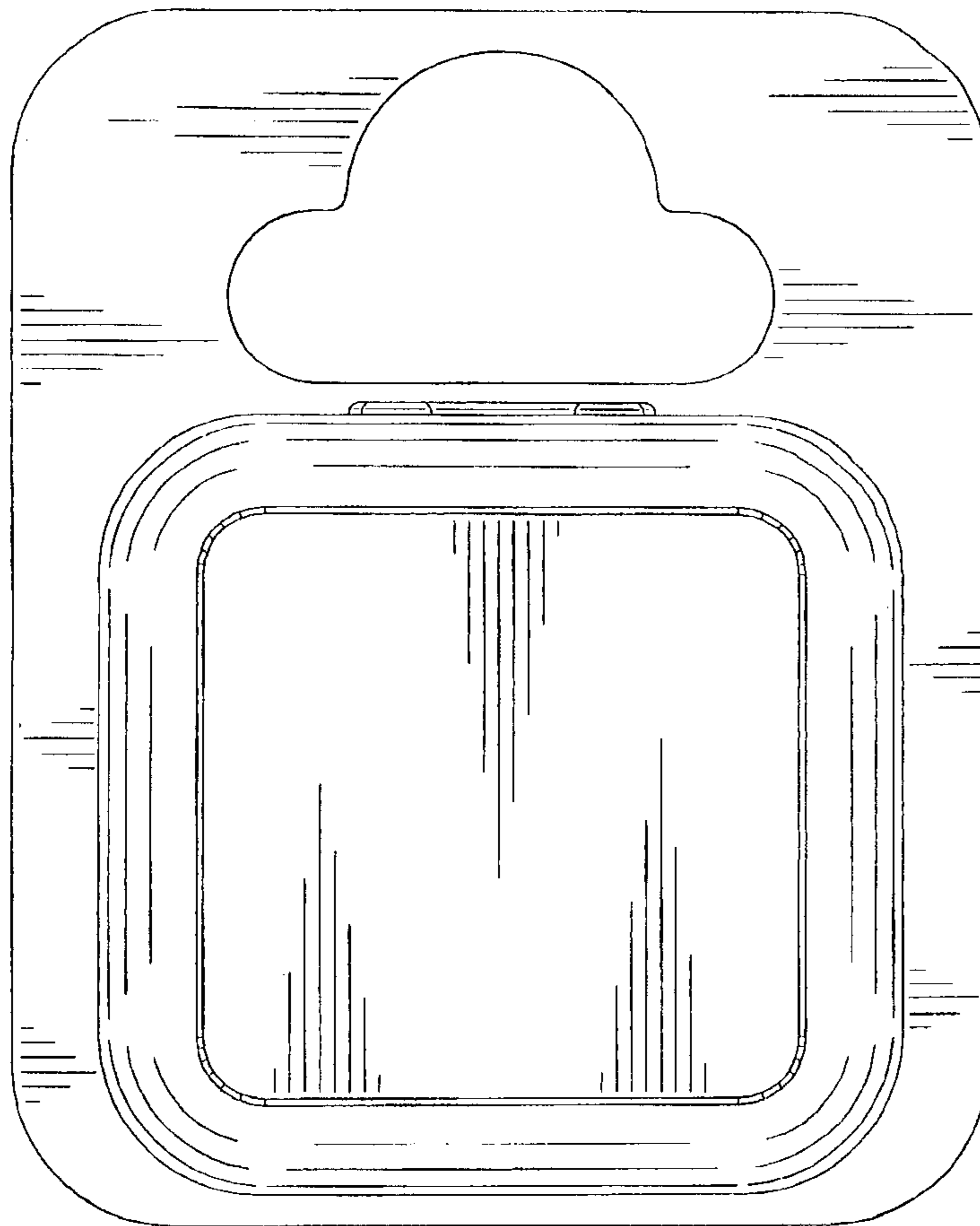

FIG. 9

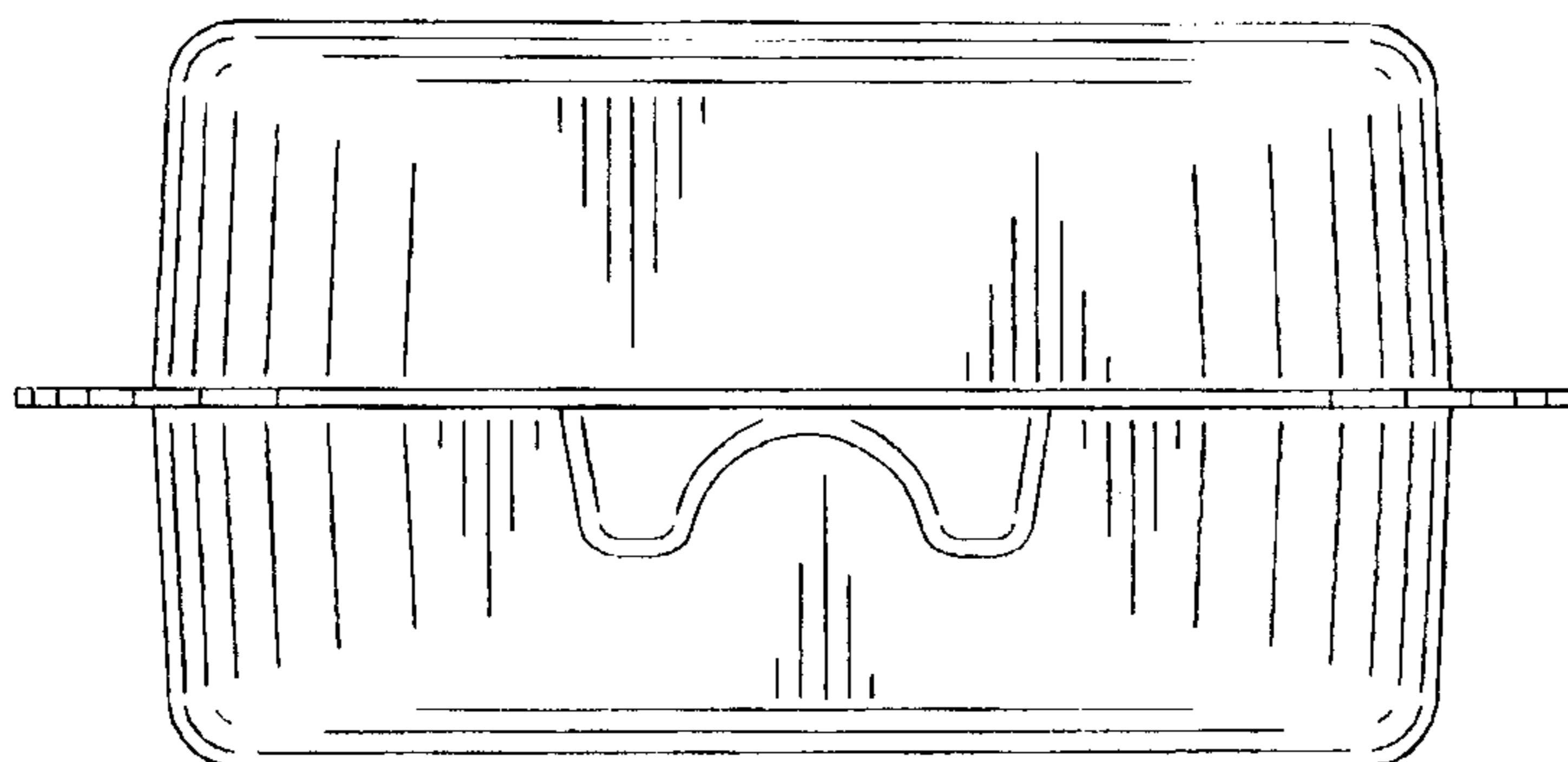

FIG. 10

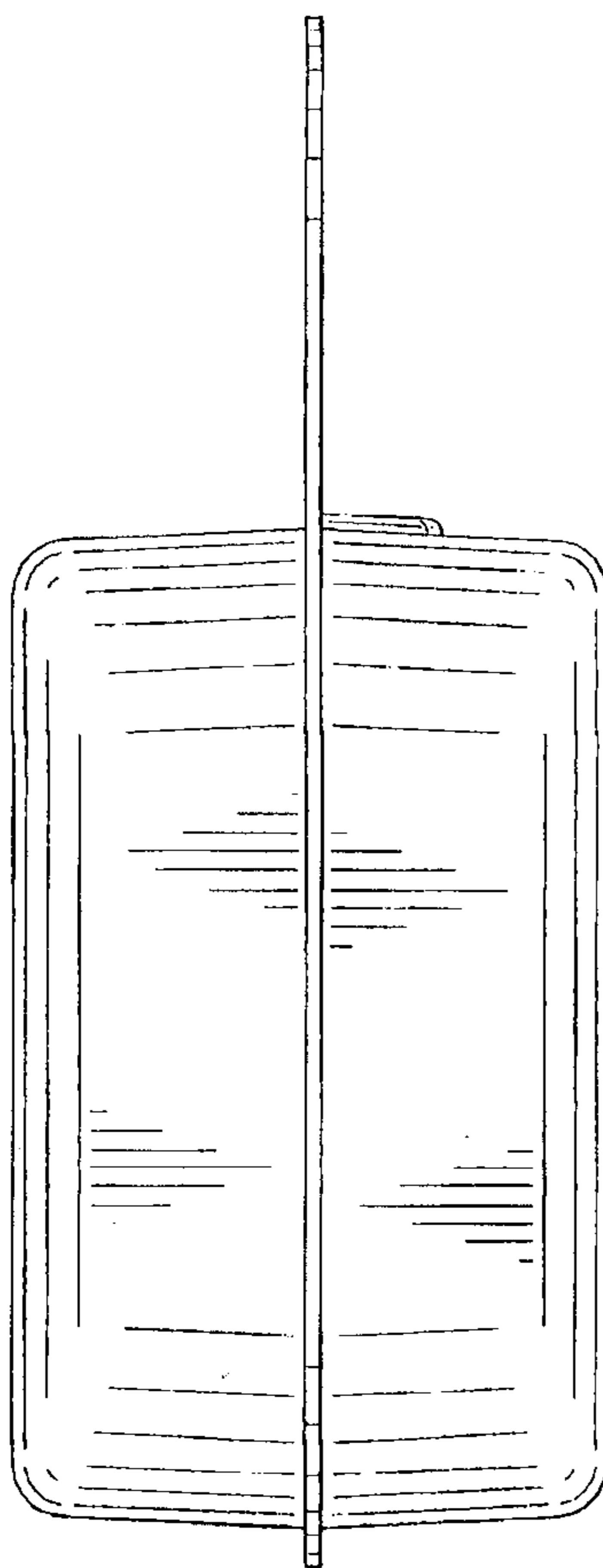

FIG. 11

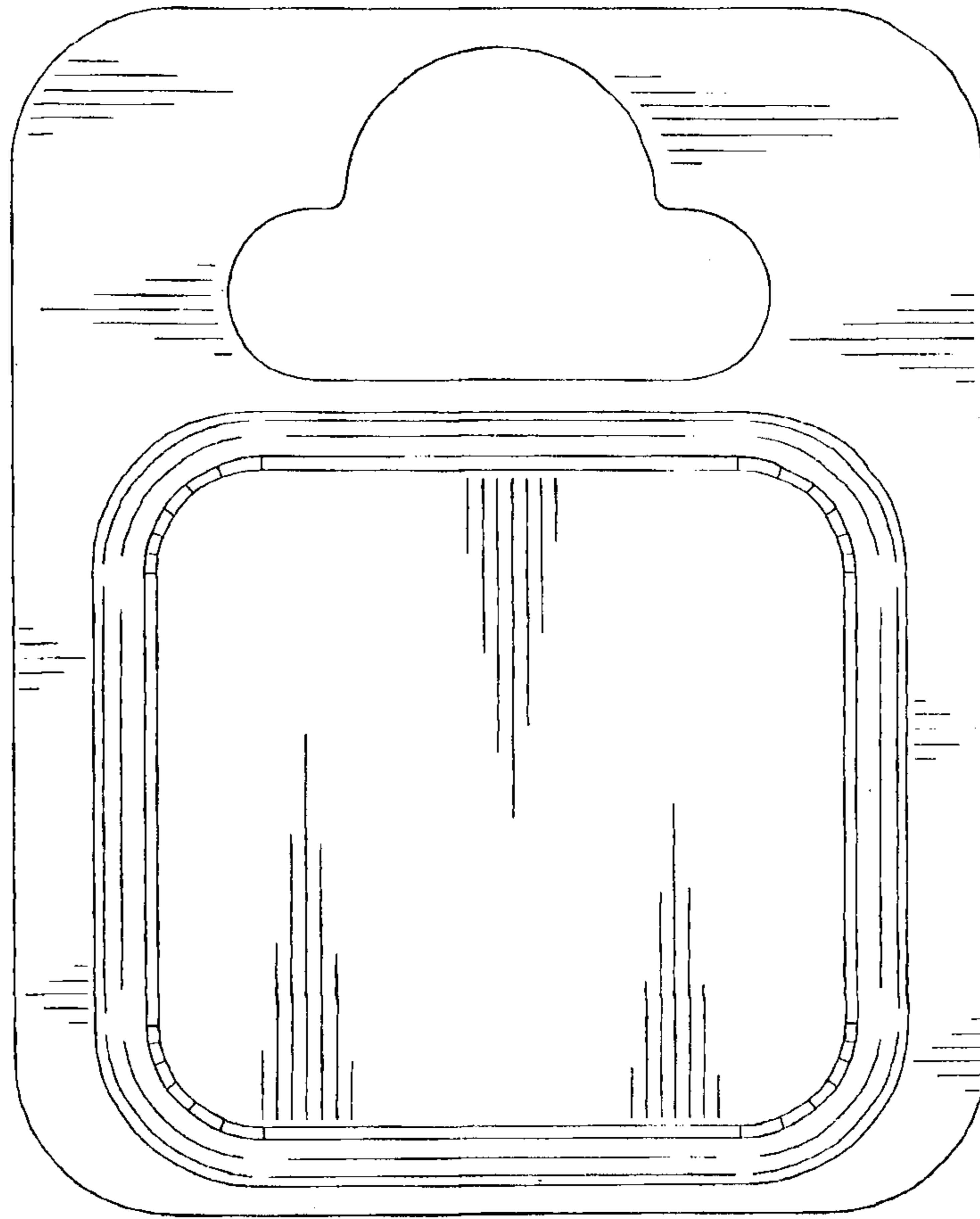

FIG. 12

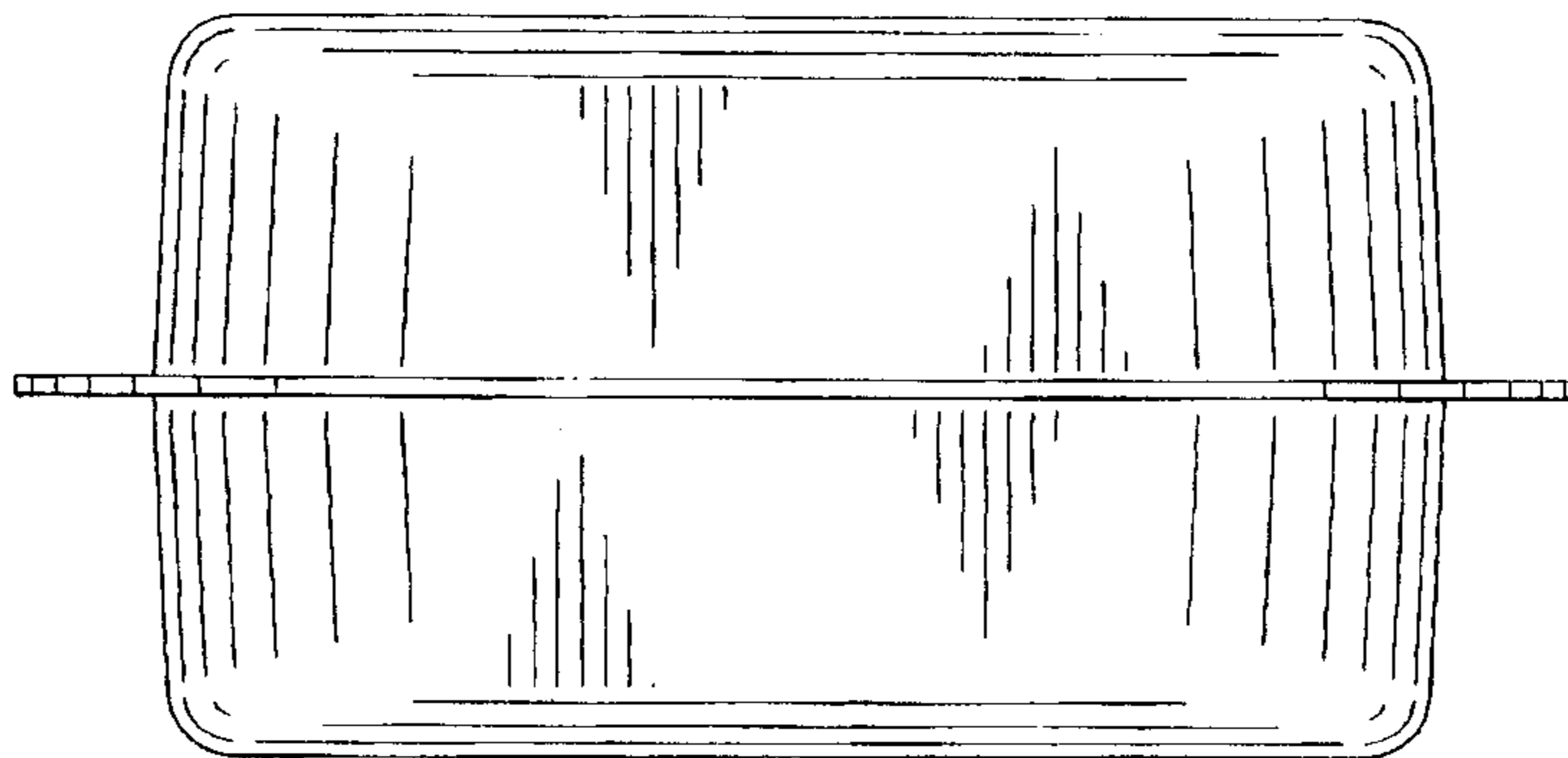

FIG. 13

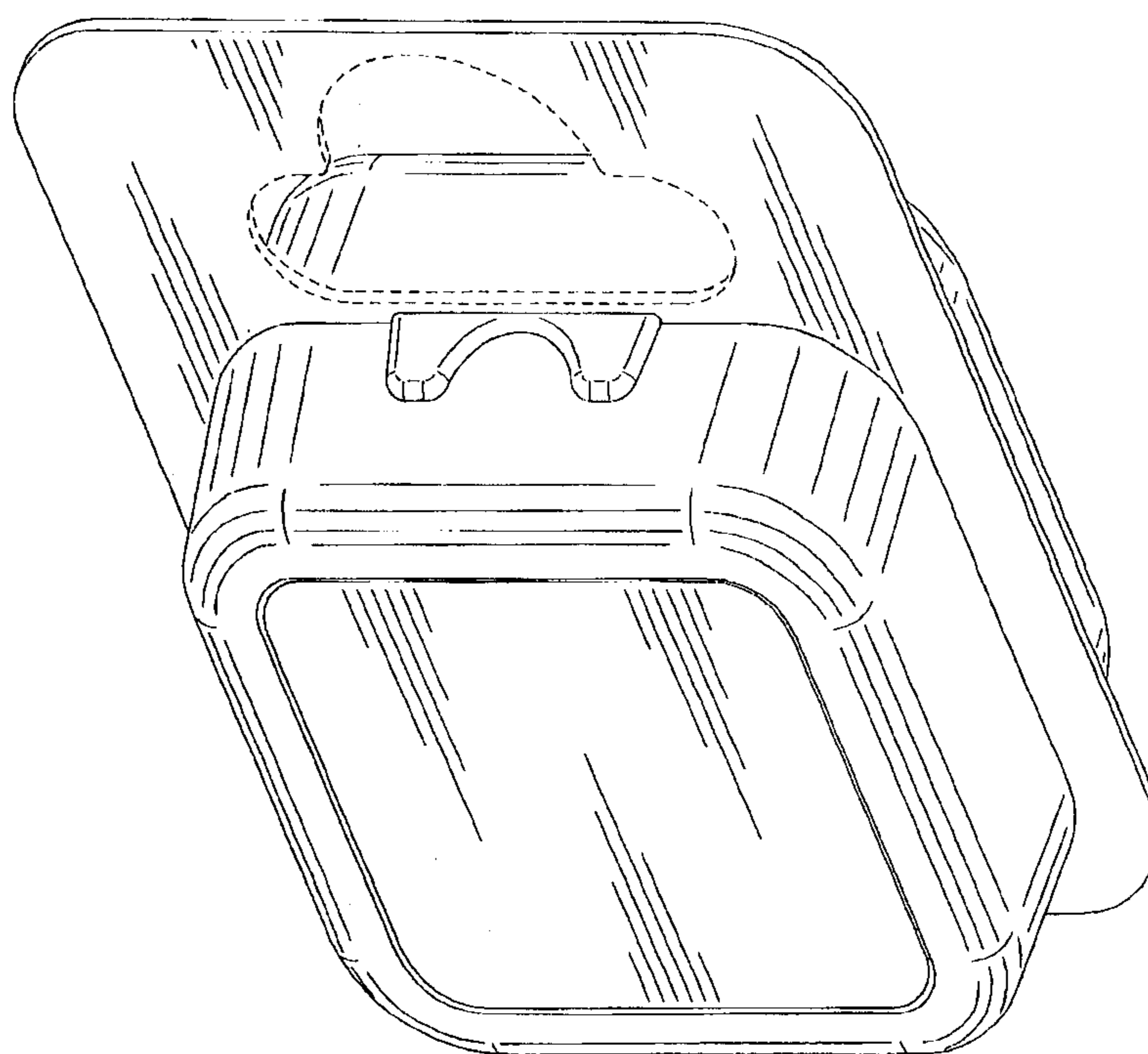

FIG. 14

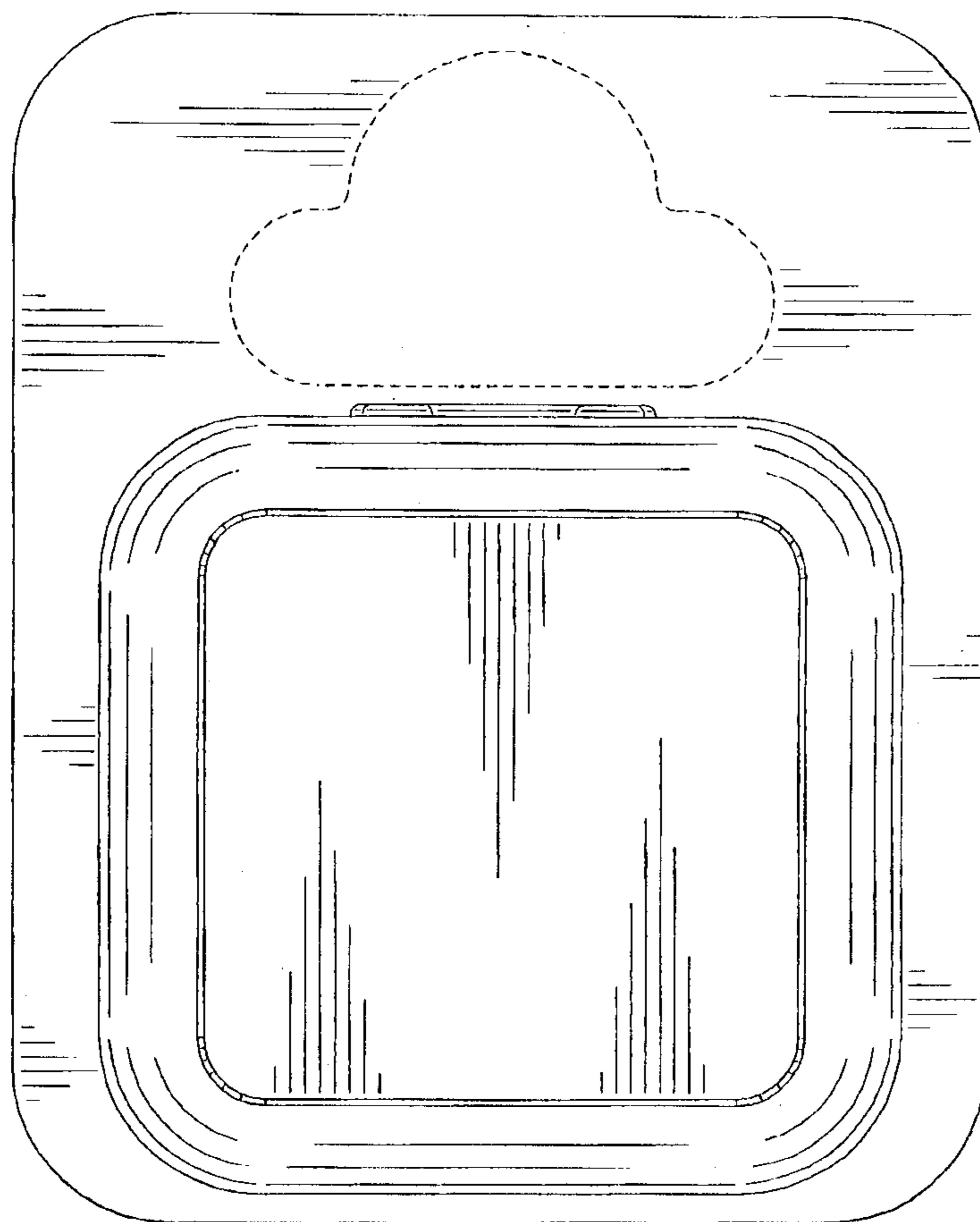

FIG. 15

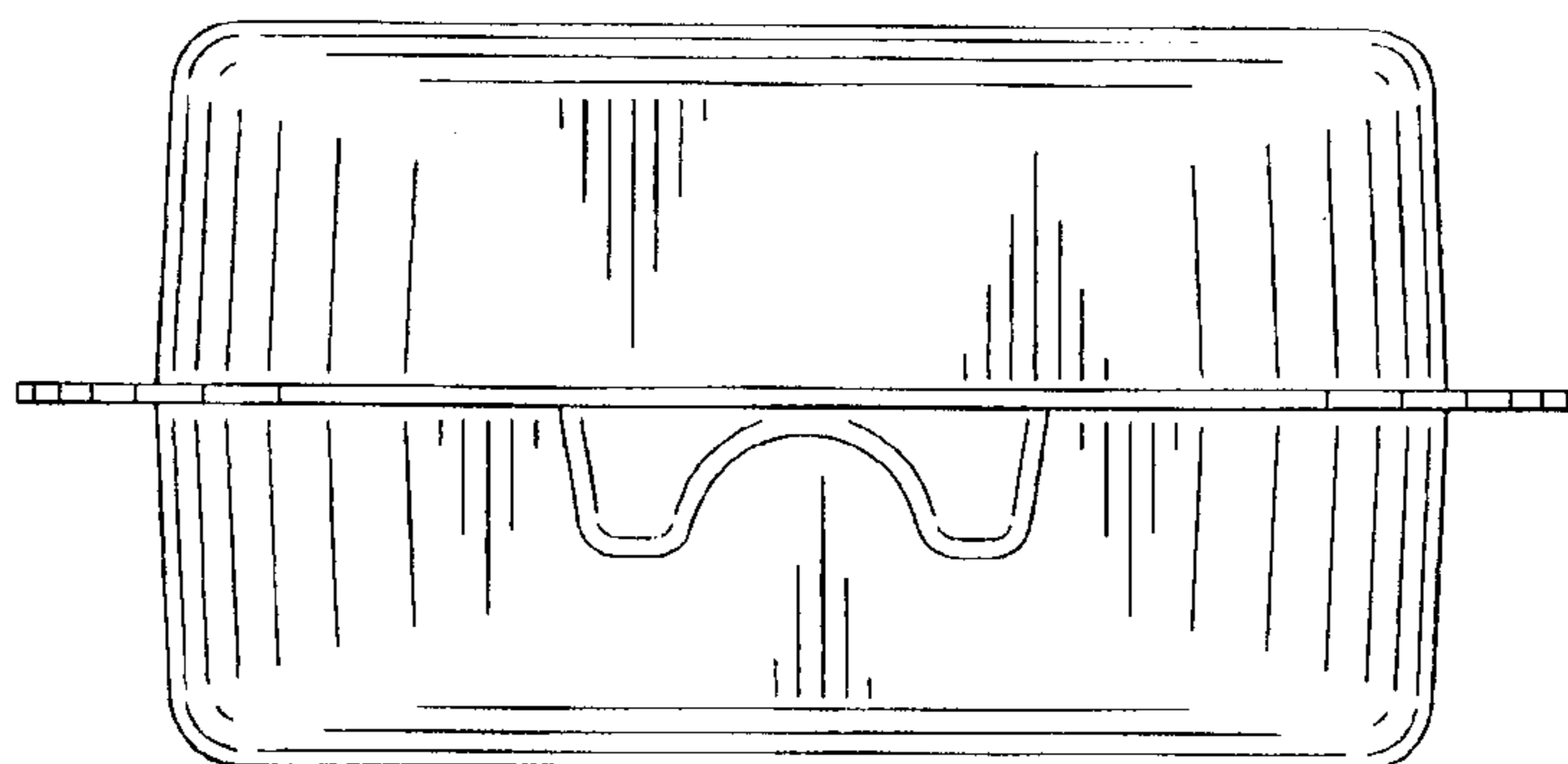

FIG. 16

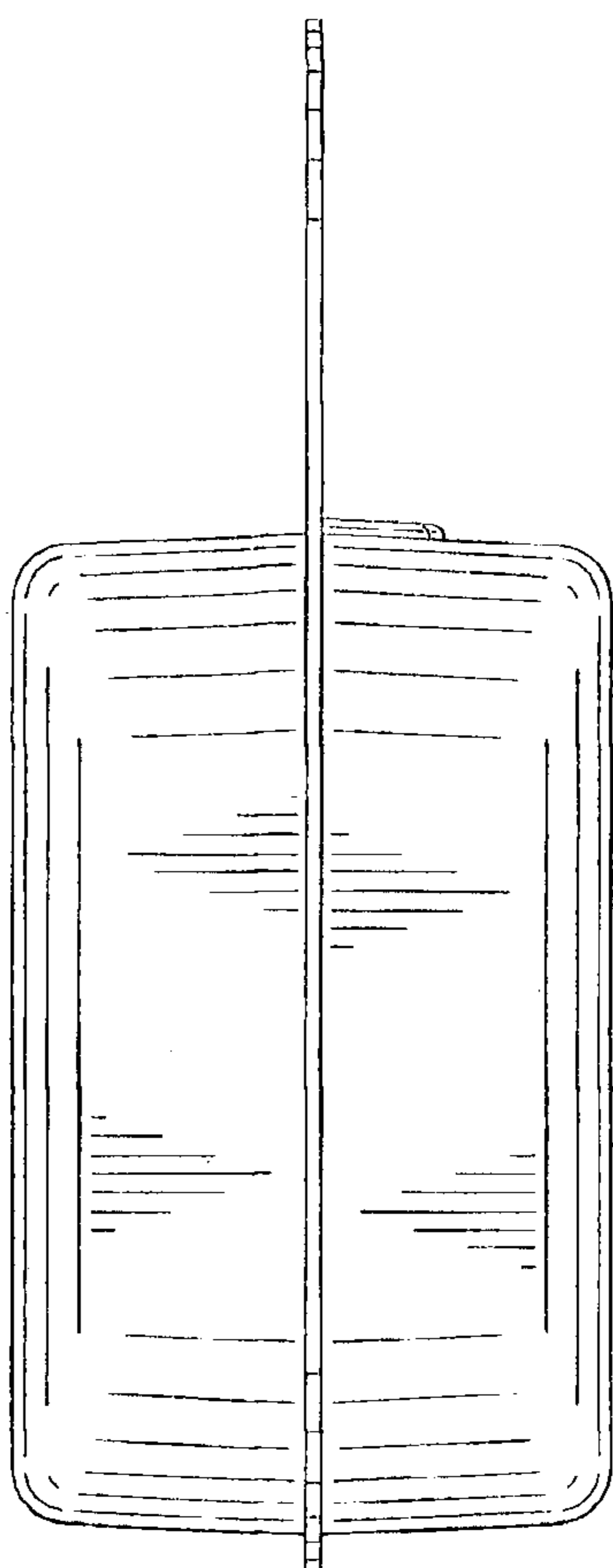

FIG. 17

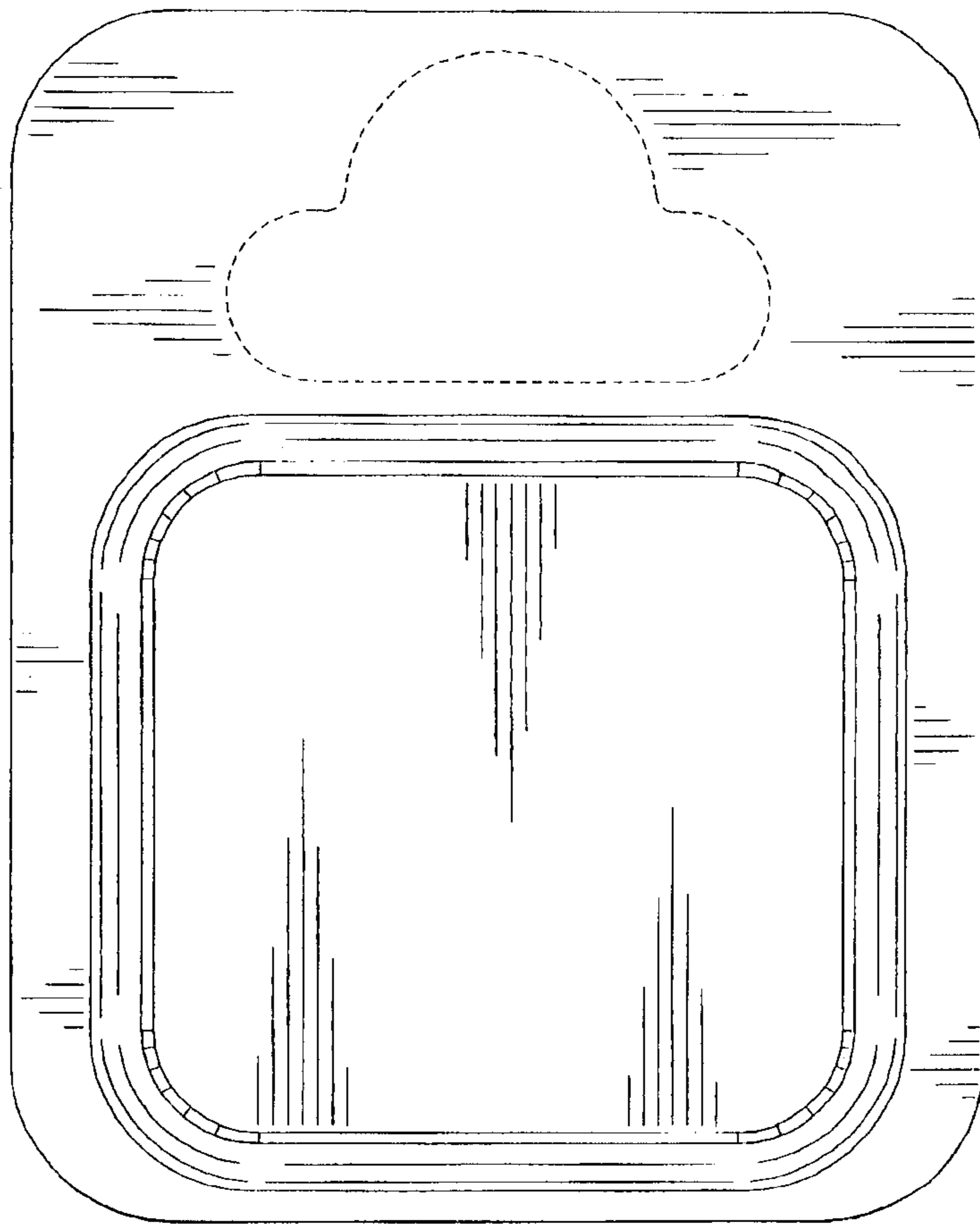

FIG. 18

