



US00D632941S

(12) **United States Design Patent**
Noniewicz

(10) **Patent No.:** **US D632,941 S**

(45) **Date of Patent:** **** Feb. 22, 2011**

(54) **DRILL GUIDE**

(75) Inventor: **Zbigniew Noniewicz**, Kempenich (DE)

(73) Assignee: **Wolcraft GmbH**, Kempenich (DE)

(**) Term: **14 Years**

(21) Appl. No.: **29/331,171**

(22) Filed: **Jan. 21, 2009**

(30) **Foreign Application Priority Data**

Dec. 12, 2008 (EM) 001055776

(51) **LOC (9) Cl.** **08-05**

(52) **U.S. Cl.** **D8/70; D8/71**

(58) **Field of Classification Search** D8/70-71;
248/601; 403/377; 408/14, 16, 75, 76, 84,
408/103-115 G, 202, 241 G; 606/96, 180
See application file for complete search history.

(56) **References Cited**

U.S. PATENT DOCUMENTS

1,295,052 A * 2/1919 Nelson 408/111
5,207,681 A * 5/1993 Ghadjar et al. 606/96

* cited by examiner

Primary Examiner—Antoine D Davis
(74) *Attorney, Agent, or Firm*—K&L Gates LLP

(57) **CLAIM**

The ornamental design for a drill guide, as shown and described.

DESCRIPTION

A portion of the disclosure of this patent document contains material to which a claim for copyright is made. The copyright owner has no objection to the facsimile reproduction by anyone of the patent document or the patent disclosure, as it appears in the Patent and Trademark Office patent file or records, but reserves all other copyright rights whatsoever.

FIG. 1 is a front view of one embodiment of the drill guide.

FIG. 2 is a right side view of the drill guide of FIG. 1.

FIG. 3 is a rear view of the drill guide of FIG. 1.

FIG. 4 is a left side view of the drill guide of FIG. 1.

FIG. 5 is a top view of the drill guide of FIG. 1.

FIG. 6 is a bottom view of the drill guide of FIG. 1.

FIG. 7 is a top perspective view of the drill guide of FIG. 1; and,

FIG. 8 is a bottom perspective view of the drill guide of FIG. 1.

1 Claim, 4 Drawing Sheets

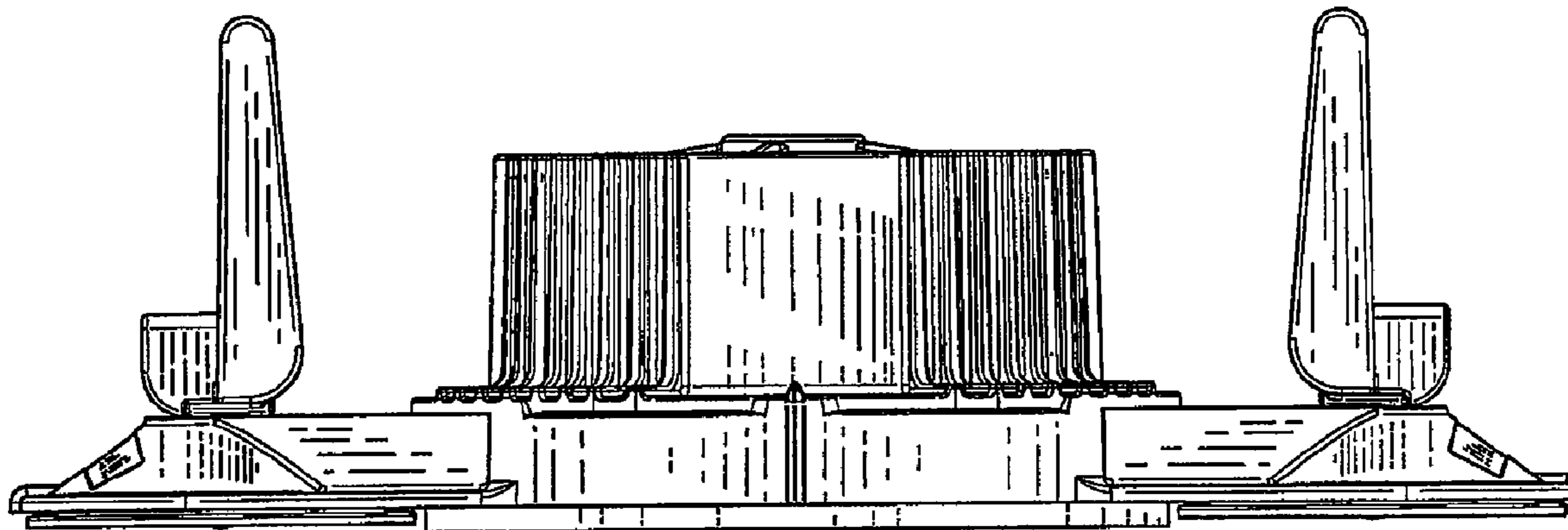

Fig. 1

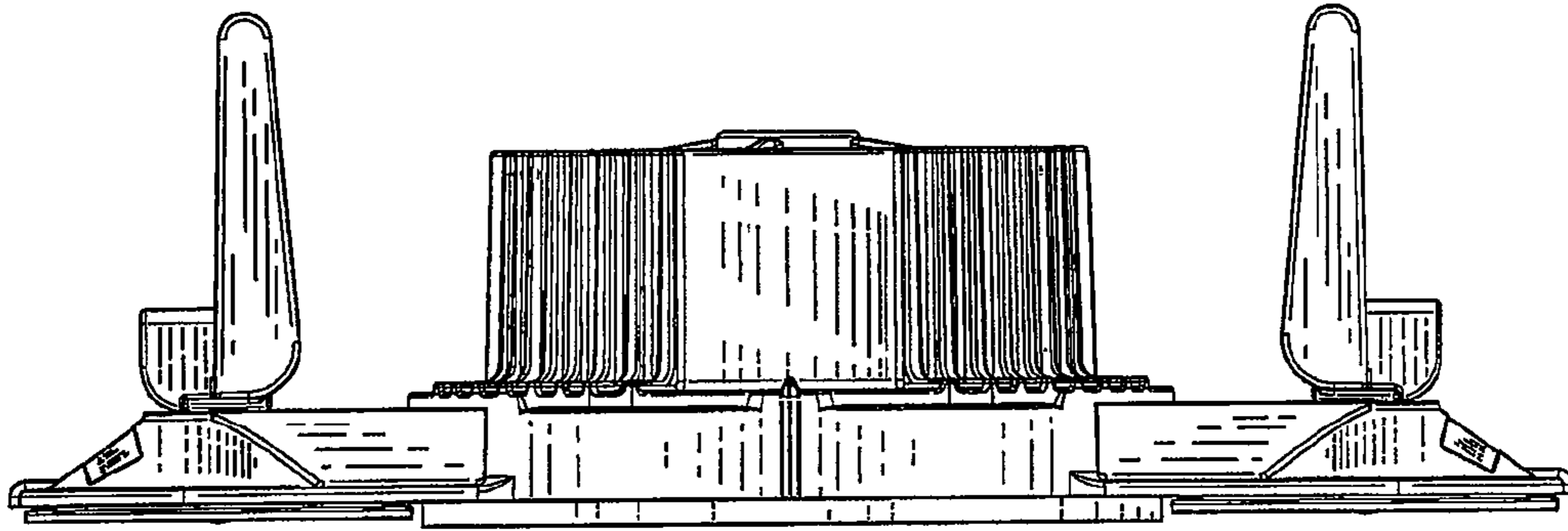

Fig. 2

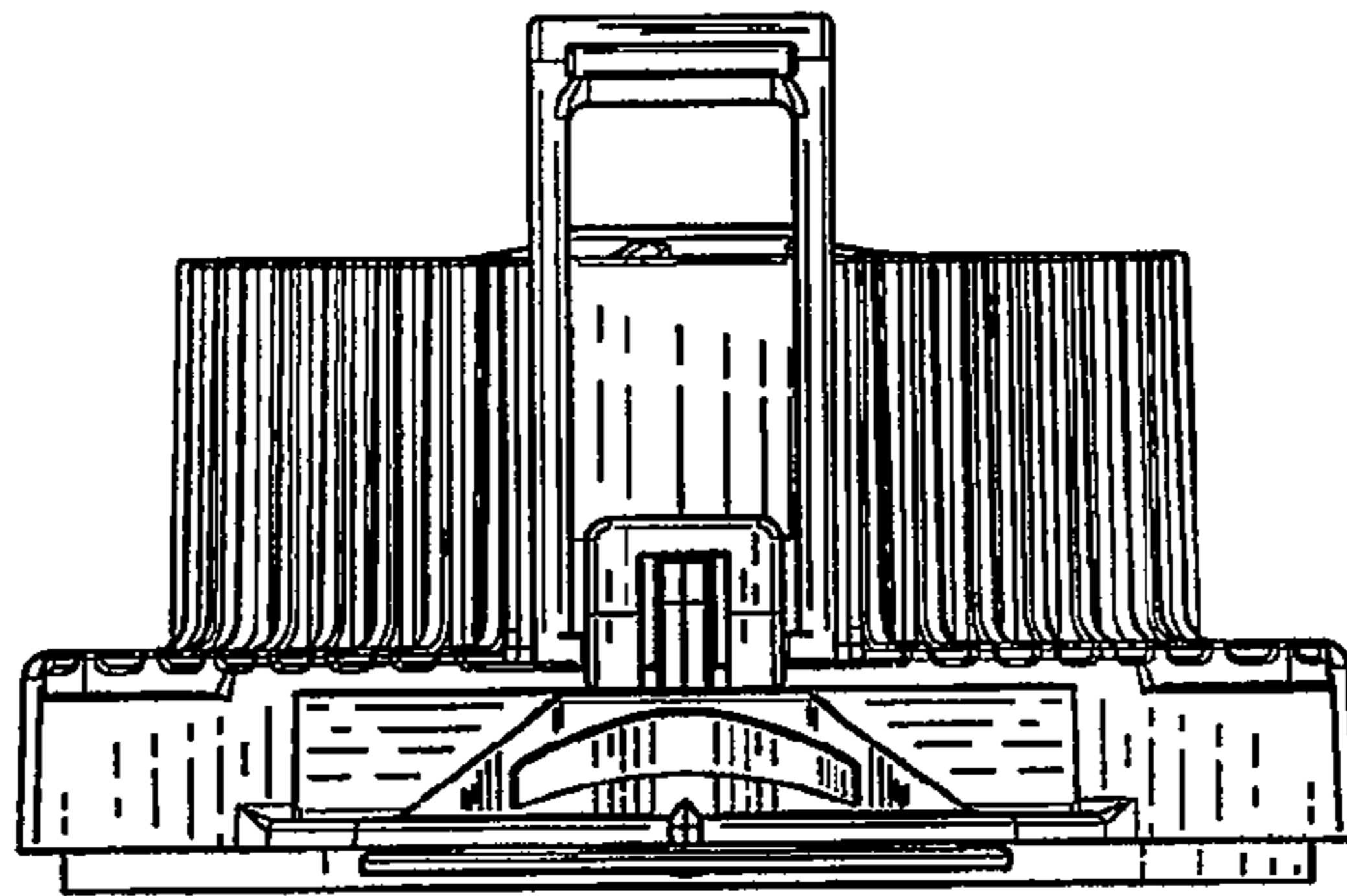

Fig. 3

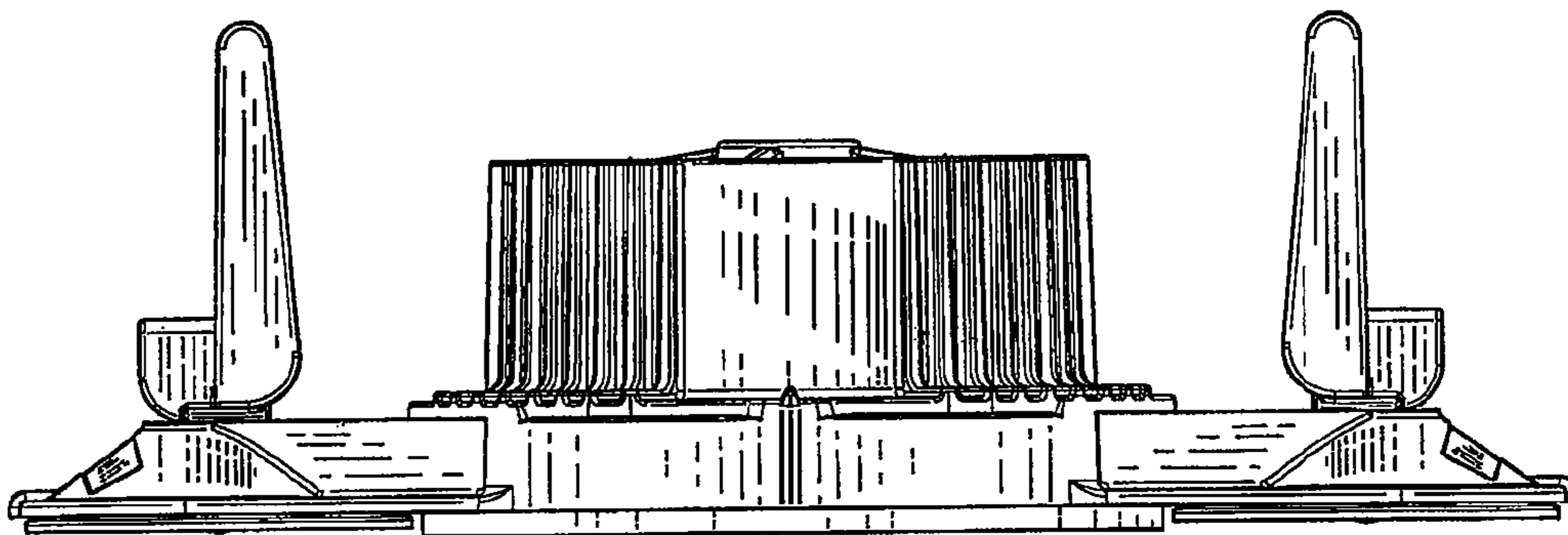

Fig. 4

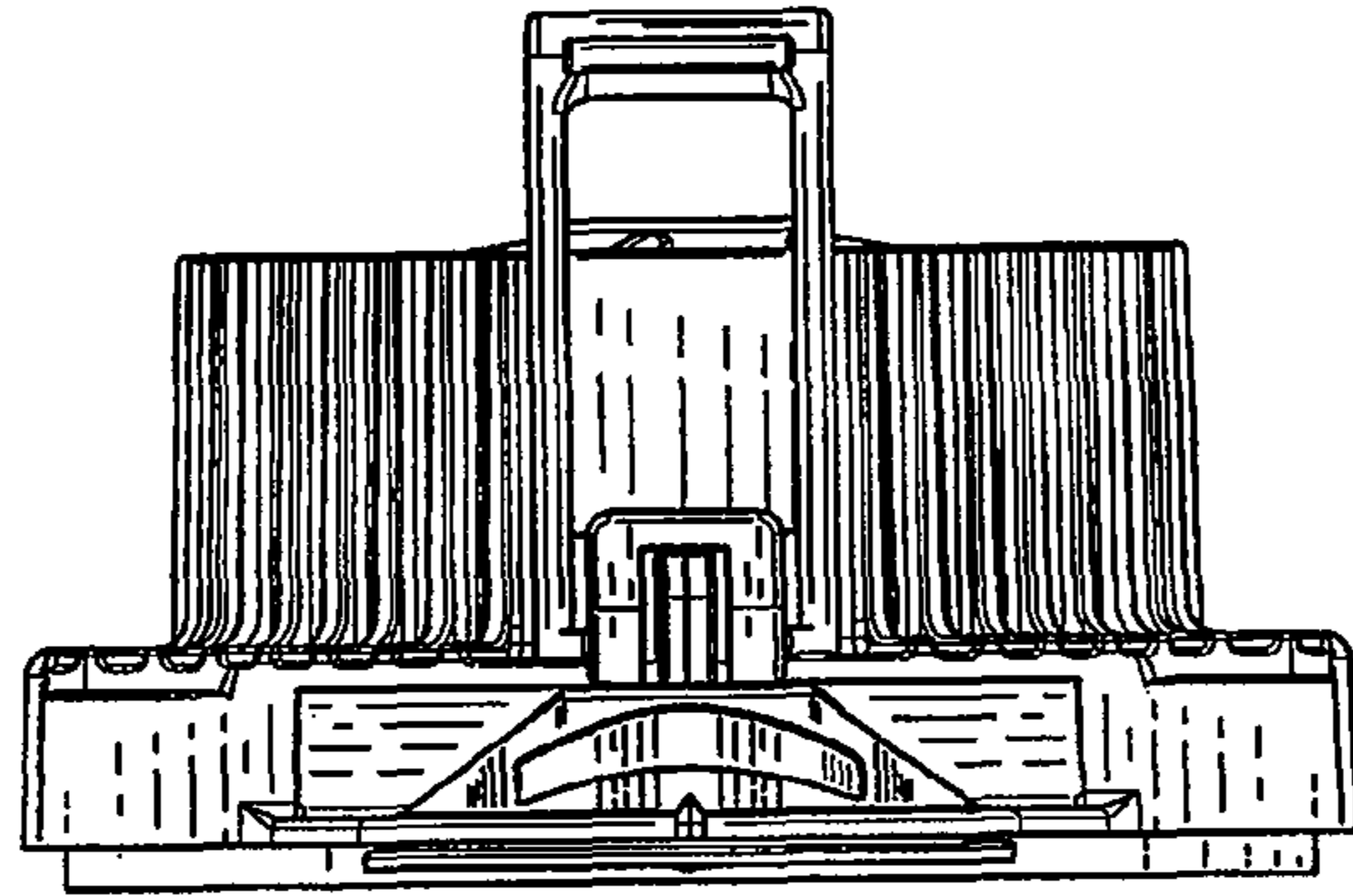

Fig. 5

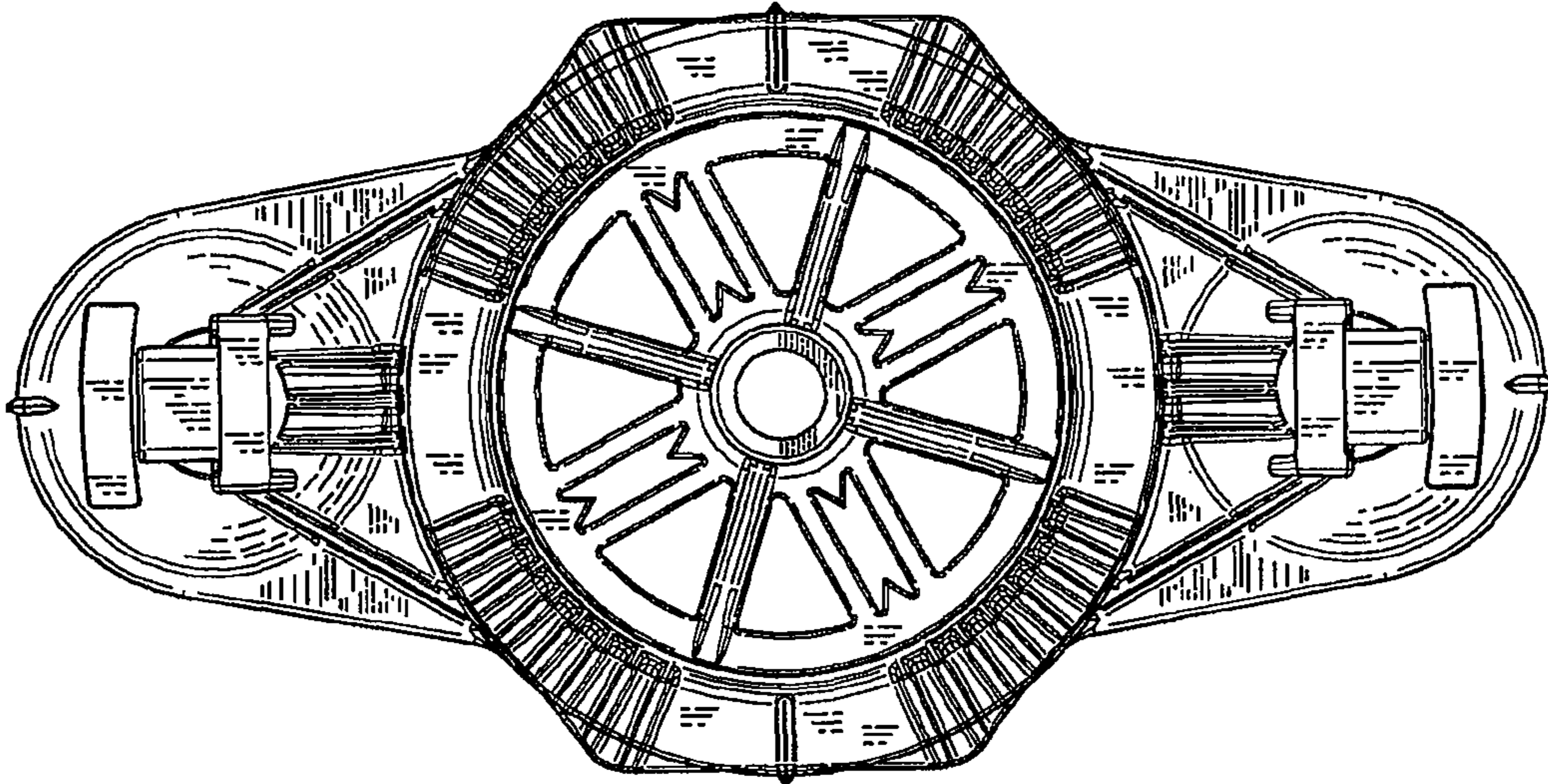

Fig. 6

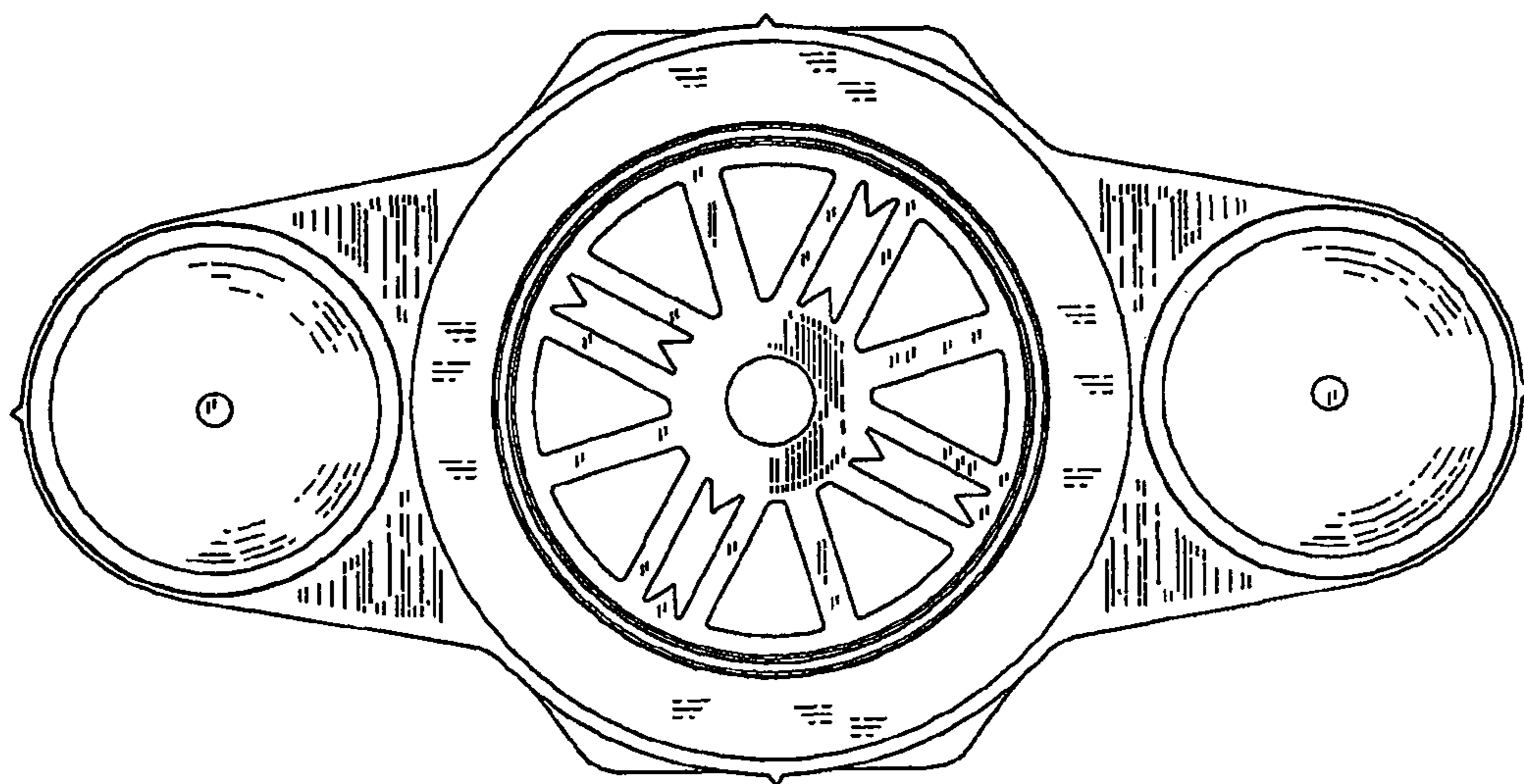

Fig. 7

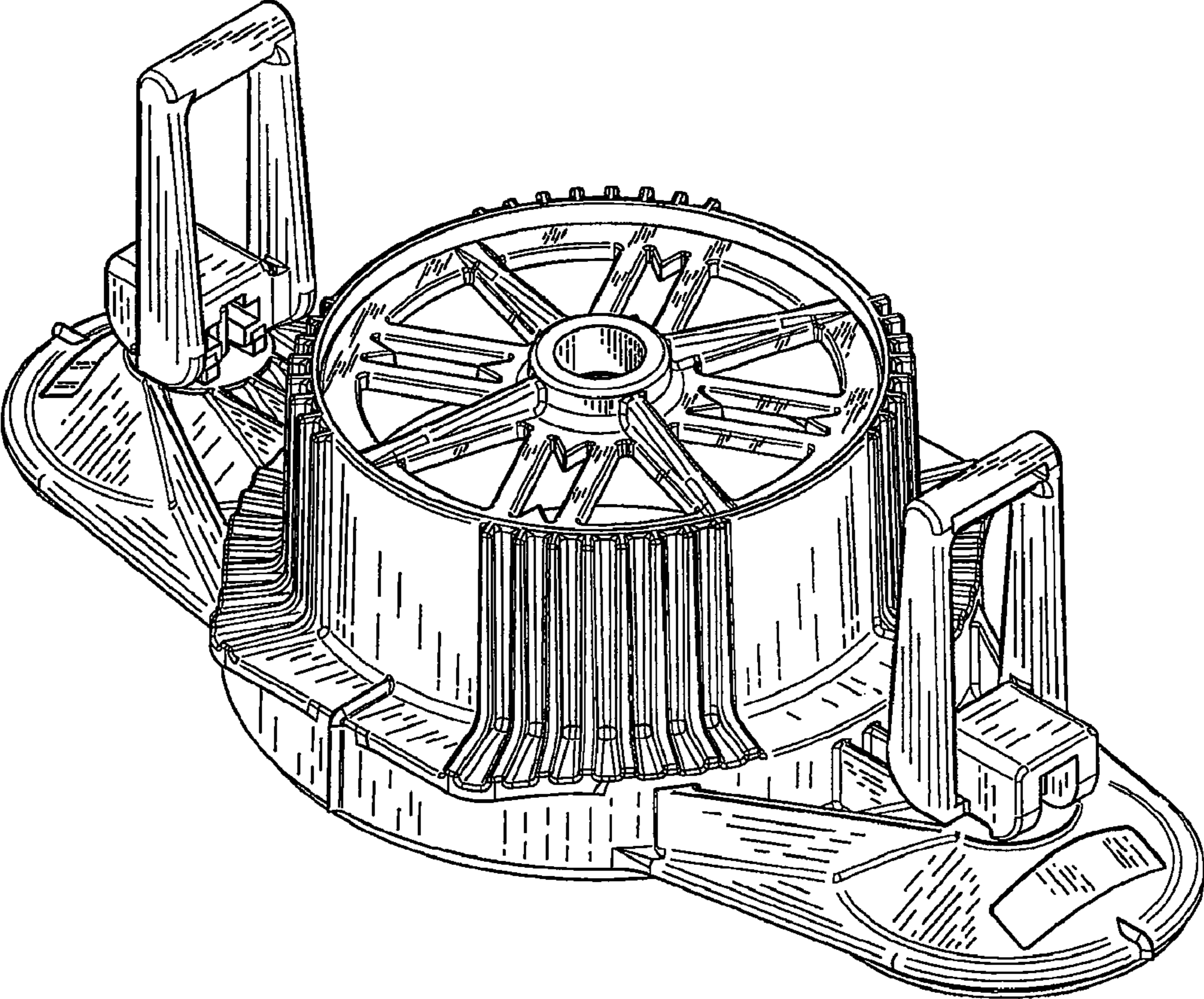

Fig. B

