



US00D632915S

(12) **United States Design Patent**  
**Pitzer**

(10) **Patent No.:** **US D632,915 S**

(45) **Date of Patent:** **\*\* Feb. 22, 2011**

(54) **PHOTO SLEEVE ENHANCED TABLECLOTH**

(76) Inventor: **Denise Pitzer**, 889 Holly Tree Gap Rd.,  
Brentwood, TN (US) 37027

(\*\*) Term: **14 Years**

(21) Appl. No.: **29/335,304**

(22) Filed: **Apr. 13, 2009**

(51) **LOC (9) Cl.** ..... **06-13**

(52) **U.S. Cl.** ..... **D6/617**

(58) **Field of Classification Search** ..... D6/610–613,  
D6/615–618, 602, 603; 108/90; 5/495; 150/154,  
150/158; 43/112

See application file for complete search history.

(56) **References Cited**

**U.S. PATENT DOCUMENTS**

D161,572	S	*	1/1951	Davis	.....	D6/616
3,825,050	A	*	7/1974	Glover	.....	108/90
3,960,193	A	*	6/1976	Davis	.....	108/90
4,620,396	A	*	11/1986	Bjorntwedt	.....	D6/610
D318,971	S	*	8/1991	Mitchell	.....	D6/617
5,107,620	A	*	4/1992	Mahan	.....	43/112
D336,812	S	*	6/1993	Walper	.....	D6/617
D380,922	S	*	7/1997	Perrotti et al.	.....	D6/618
D445,286	S	*	7/2001	Rhyne	.....	D6/610
6,431,089	B1	*	8/2002	O'Brien	.....	108/90

6,499,411	B2	*	12/2002	Brown	.....	108/90
6,508,183	B2	*	1/2003	Kerrigan	.....	108/90
7,044,067	B2	*	5/2006	Saccomandi	.....	108/90

\* cited by examiner

*Primary Examiner*—David G Muller

(74) *Attorney, Agent, or Firm*—Tracy P. Jong

(57) **CLAIM**

The ornamental design for a photo sleeve enhanced tablecloth, as shown and described.

**DESCRIPTION**

FIG. 1 is a front perspective view of a photo sleeve enhanced tablecloth showing the ornamental design of the tablecloth.

FIG. 2 is a right side perspective view thereof.

FIG. 3 is a rear perspective view thereof.

FIG. 4 is a left side perspective view thereof.

FIG. 5 is a top plan view thereof with the photo sleeves attached; and,

FIG. 6 is a top plan view thereof with the photo sleeves removed and depicting the adhering strips of the tablecloth.

The broken line showing of the table is included for the purpose of illustrating use and environment and forms no part of the claimed design.

**1 Claim, 6 Drawing Sheets**

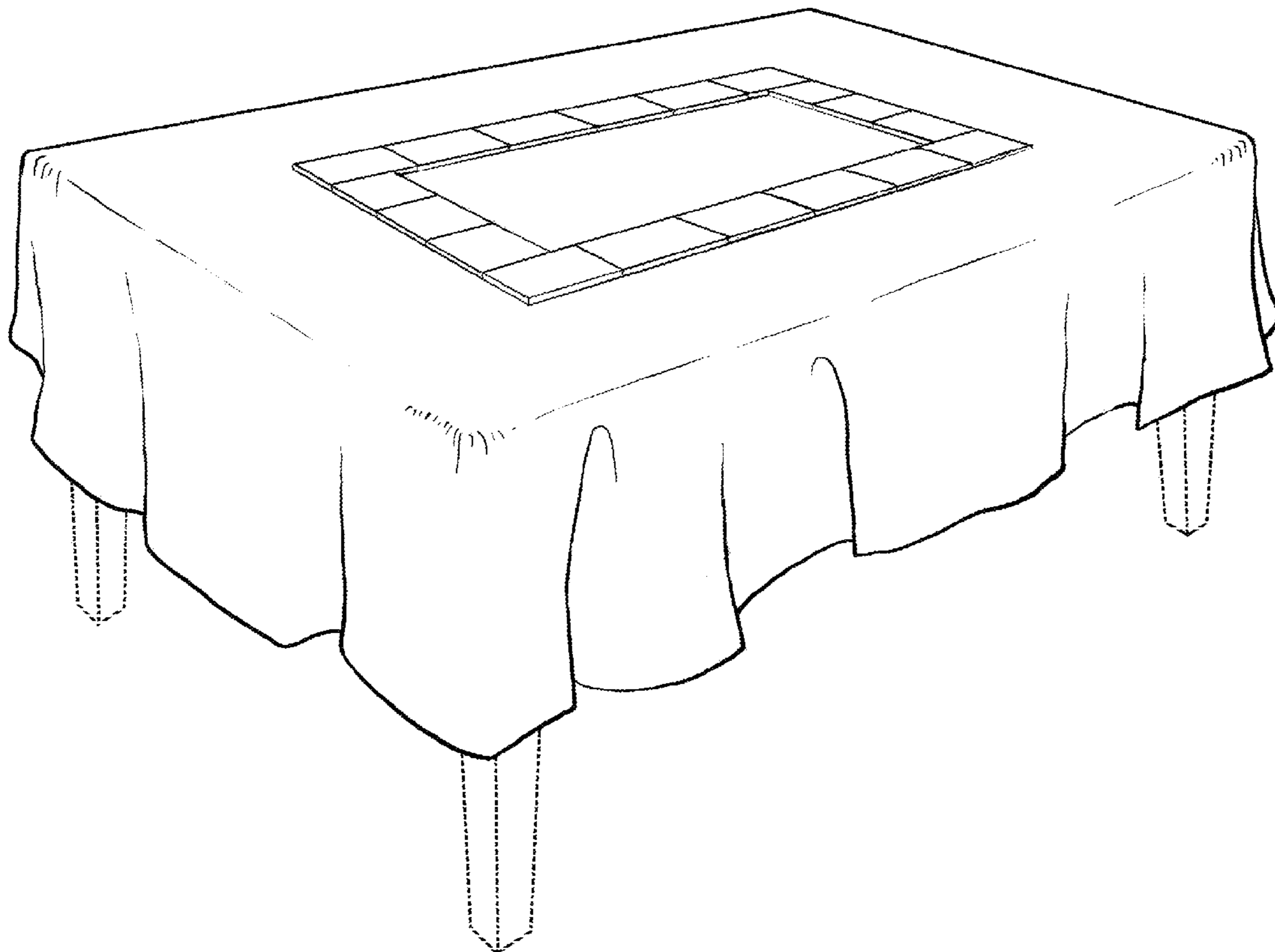

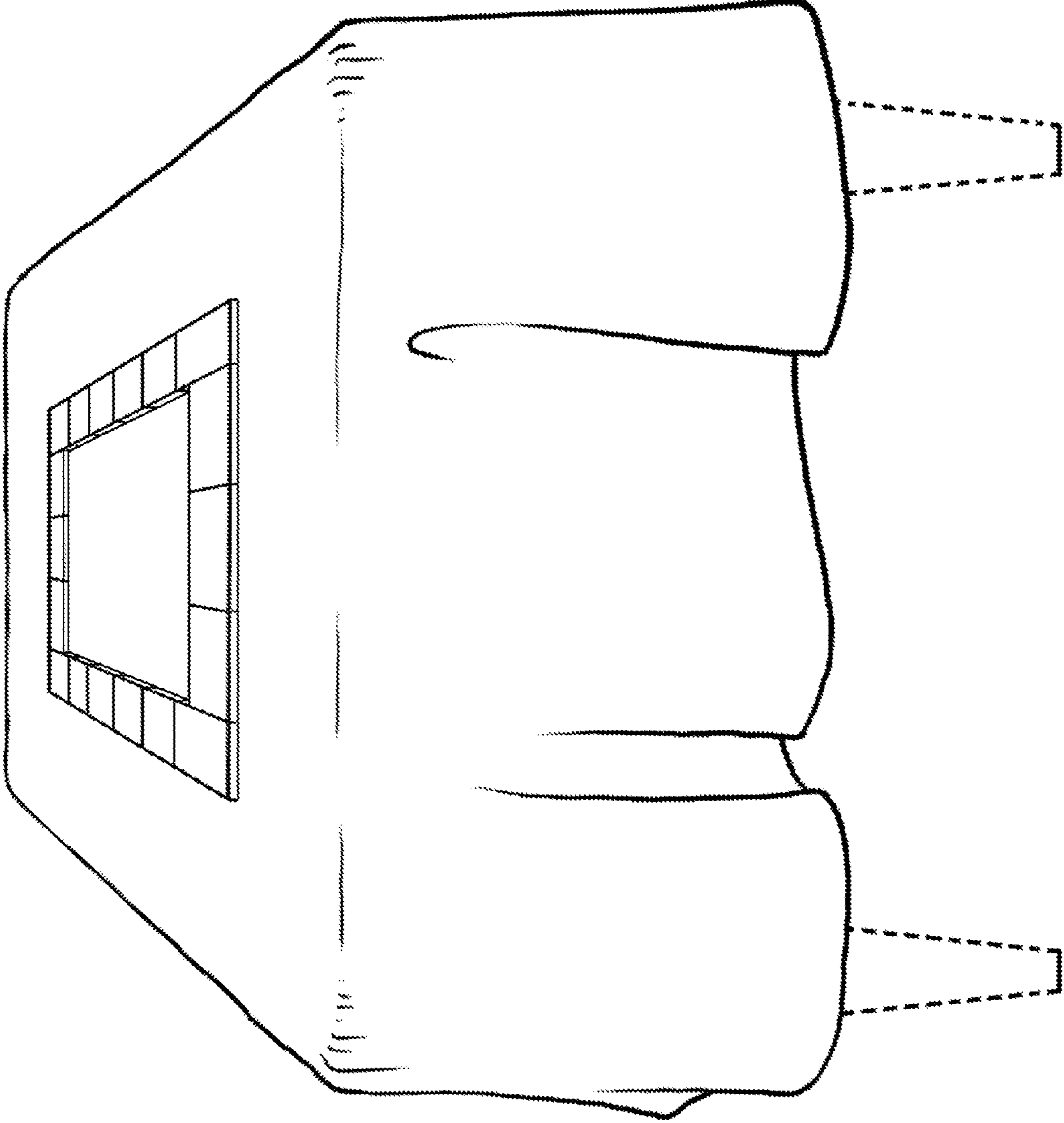

Fig. 1

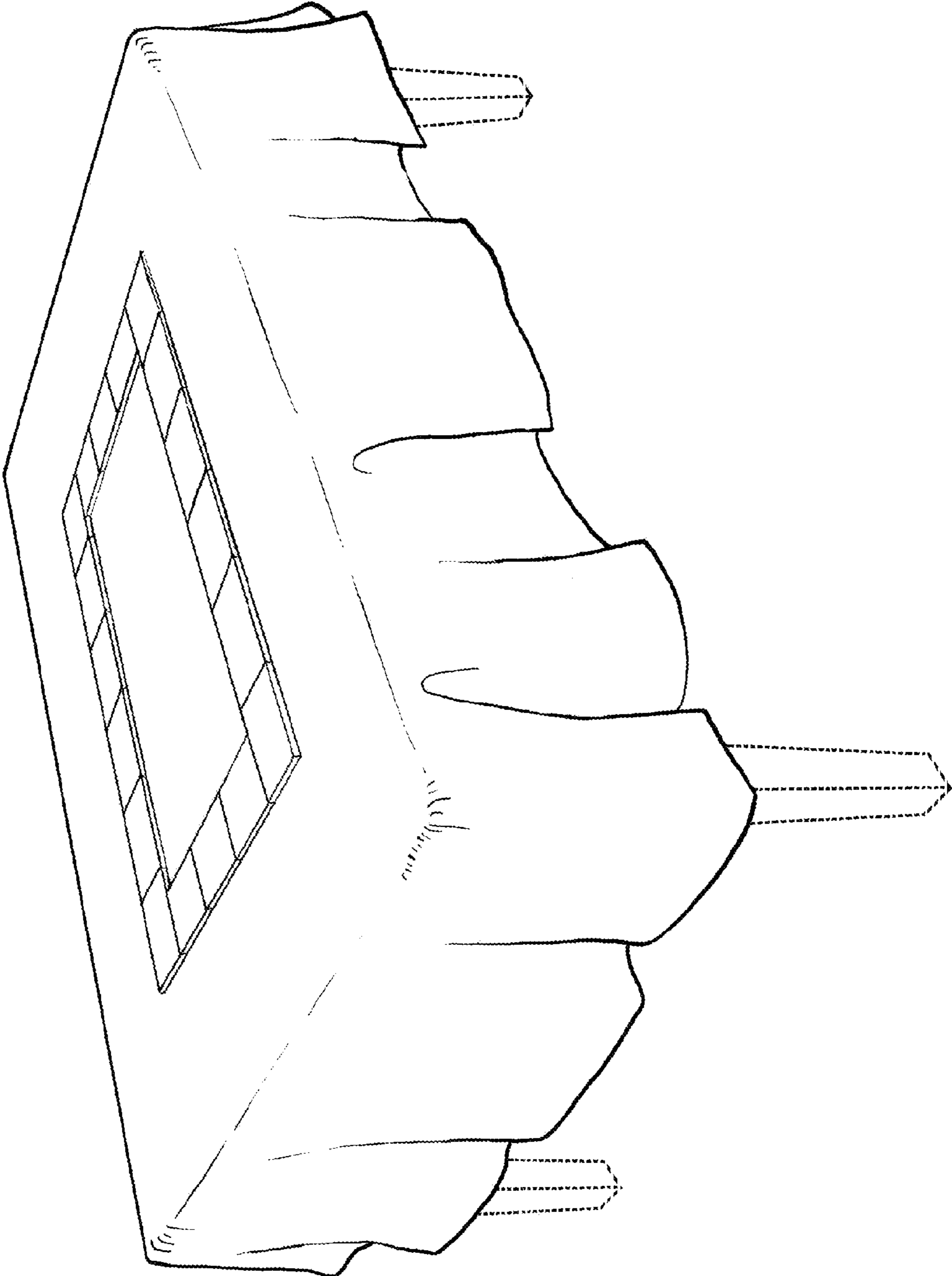

Fig. 2

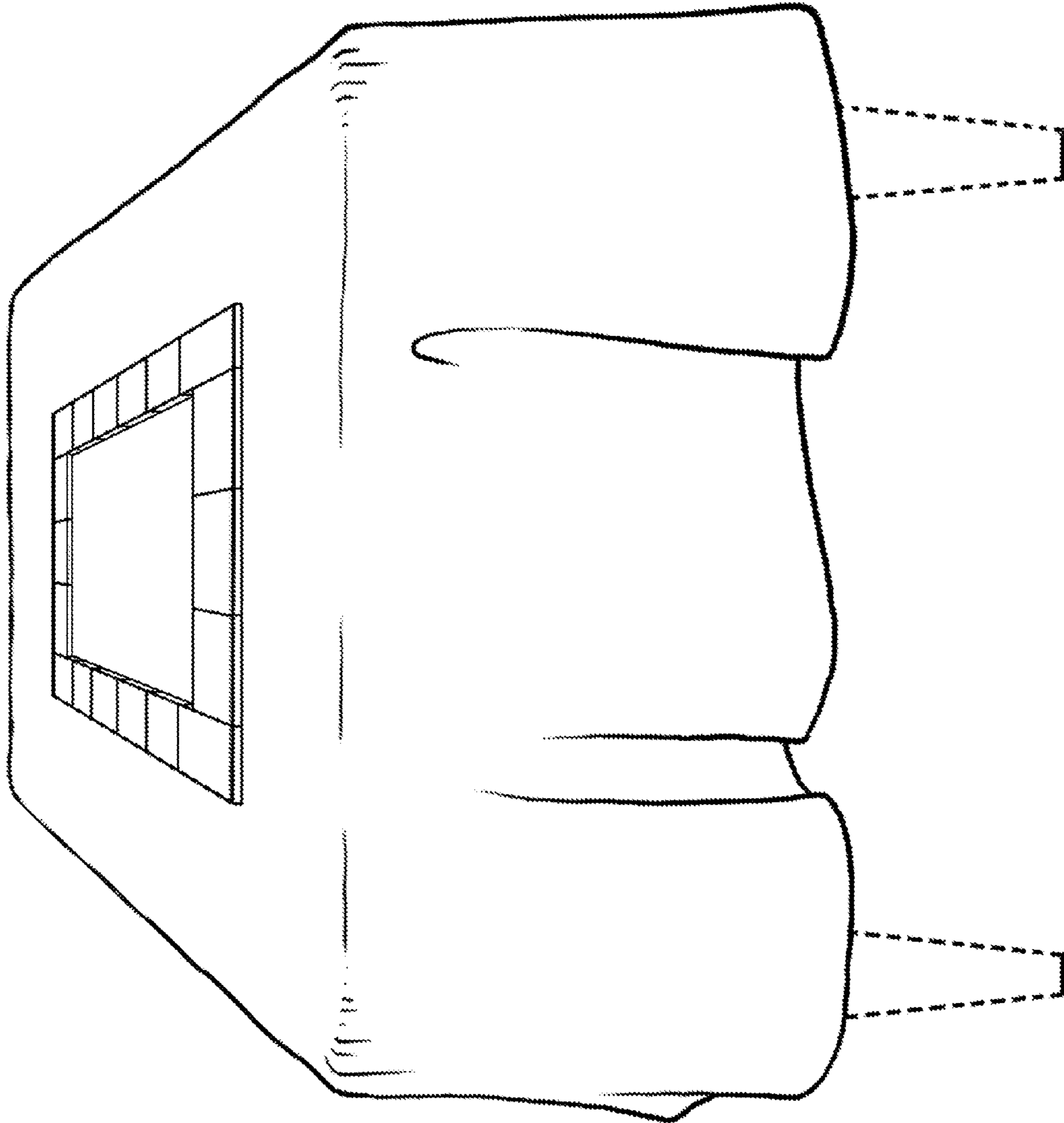

Fig. 3

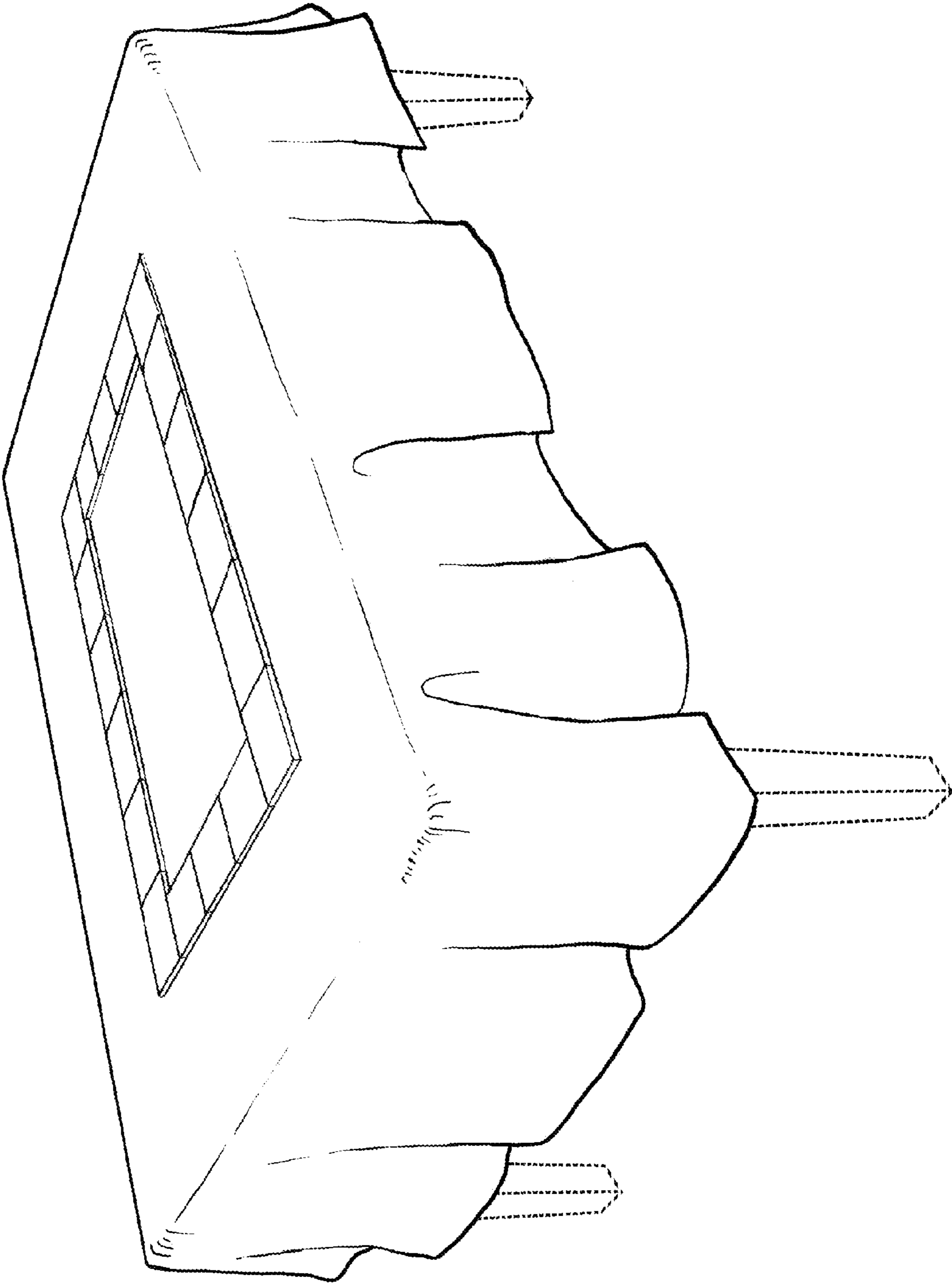

Fig. 4

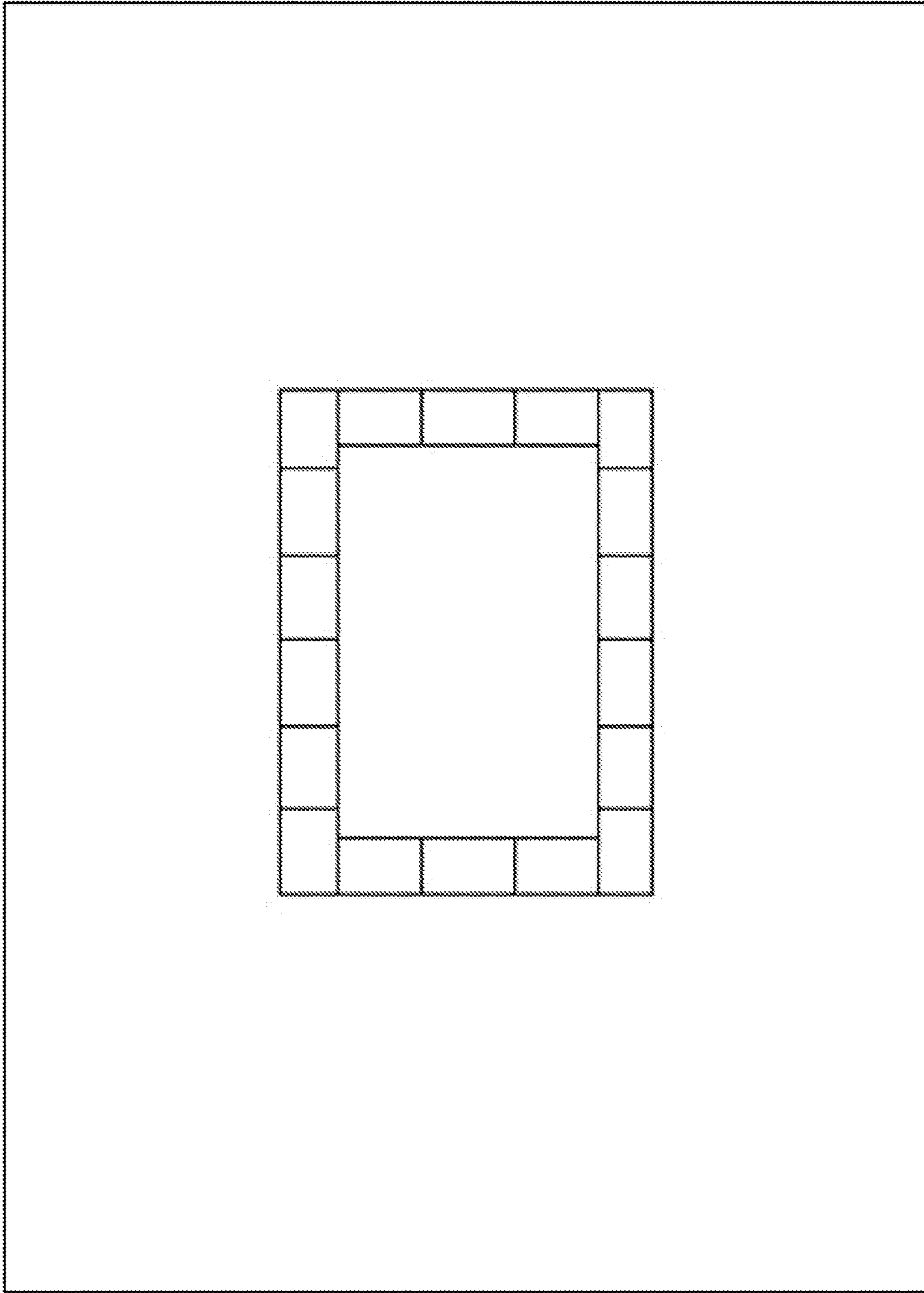

Fig. 5

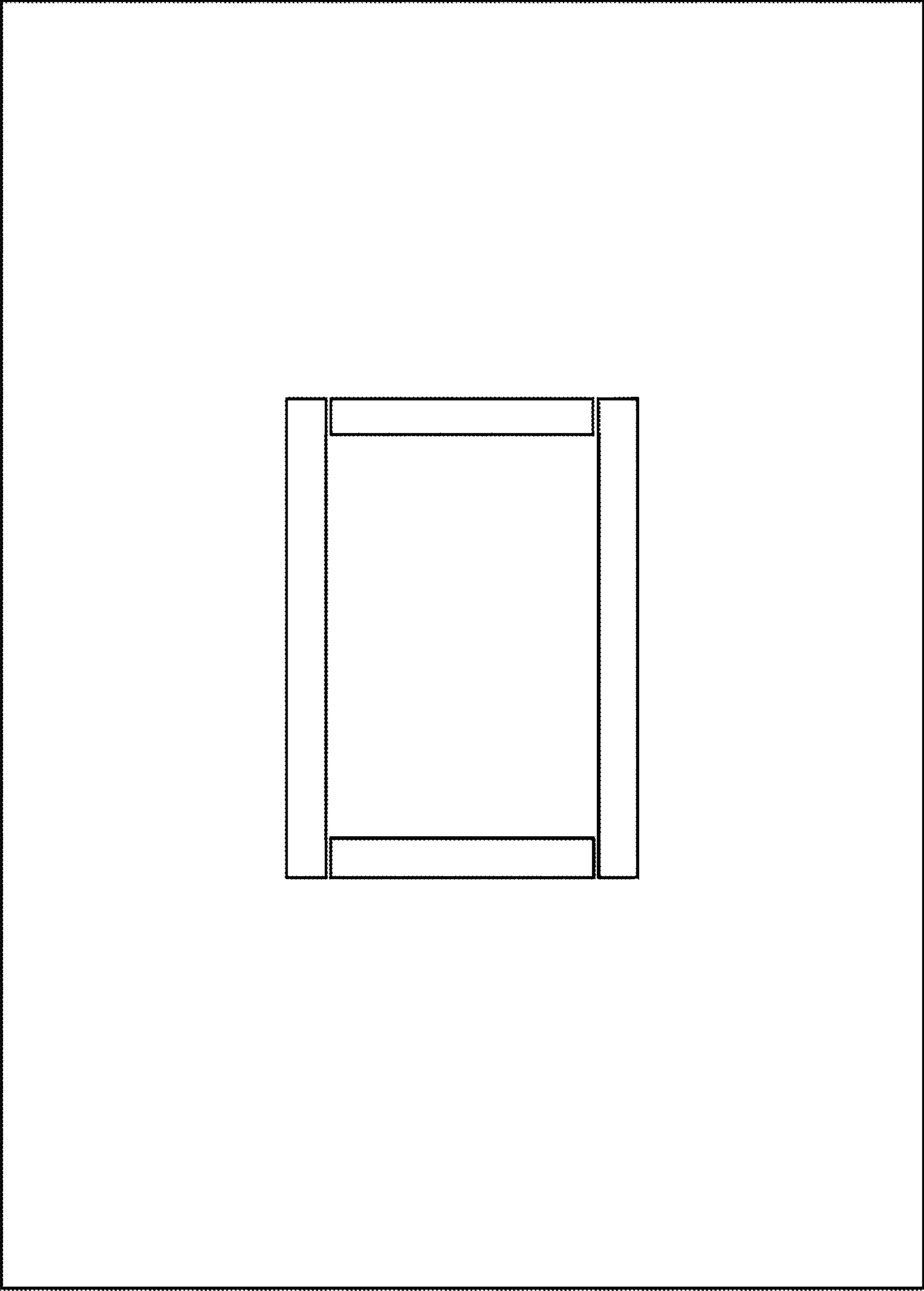

Fig. 6