

US00D632798S

(12) **United States Design Patent**  
**Tran**

(10) **Patent No.:** **US D632,798 S**

(45) **Date of Patent:** **\*\* Feb. 15, 2011**

(54) **LAVENDER SPA BOWL DESIGN**

(75) Inventor: **Minh Sang Tran**, Cambridge (CA)

(73) Assignee: **Gulfstream Inc.**, Cambridge, Ontario

(\*\*) Term: **14 Years**

(21) Appl. No.: **29/367,653**

(22) Filed: **Aug. 11, 2010**

(51) **LOC (9) Cl.** ..... **28-03**

(52) **U.S. Cl.** ..... **D24/213; D24/204**

(58) **Field of Classification Search** ..... D24/200,  
D24/211–215, 204; 601/118, 120, 121, 124,  
601/125, 130, 131, 134–137; D6/336, 500–502  
See application file for complete search history.

(56) **References Cited**

**U.S. PATENT DOCUMENTS**

D431,637 S *	10/2000	Palmer	.....	D23/277
D526,505 S *	8/2006	Gruenwald et al.	.....	D6/381
D541,060 S *	4/2007	Fugate et al.	.....	D6/335
D565,739 S *	4/2008	Tran	.....	D24/204
D585,142 S *	1/2009	Galati et al.	.....	D24/213
D610,697 S *	2/2010	Tran	.....	D24/213
D624,656 S *	9/2010	Ton	.....	D24/204
D628,704 S *	12/2010	Tran	.....	D24/204
2004/0177438 A1 *	9/2004	Gruenwald et al.	.....	4/560.1
2007/0226896 A1 *	10/2007	Fugate et al.	.....	4/622

\* cited by examiner

*Primary Examiner*—Sandra Snapp  
(74) *Attorney, Agent, or Firm*—Jones, Walker, Waechter,  
Poitevent, Carrere & Denegre, LLP

(57) **CLAIM**

The ornamental design for a lavender spa bowl, as shown and described.

**DESCRIPTION**

FIG. 1 is a prospective front-top view of the lavender spa bowl.

FIG. 2 is a prospective rear-top view of the lavender spa bowl.

FIG. 3 is a prospective top view of the lavender spa bowl.

FIG. 4 is a prospective bottom view of the lavender spa bowl.

FIG. 5 is a prospective right -side view of the lavender spa bowl.

FIG. 6 is a prospective left-side view of the lavender spa bowl.

FIG. 7 is a prospective front view of the lavender spa bowl.

FIG. 8 is a prospective rear view of the lavender spa bowl; and,

FIG. 9 is a prospective view of the lavender spa bowl mounted in a pedicure spa.

The broken lines in the drawings, particularly those depicting a massage chair and pedicure base shown in FIG. 9, are for illustrative purposes only and form no part of the claimed design.

**1 Claim, 6 Drawing Sheets**

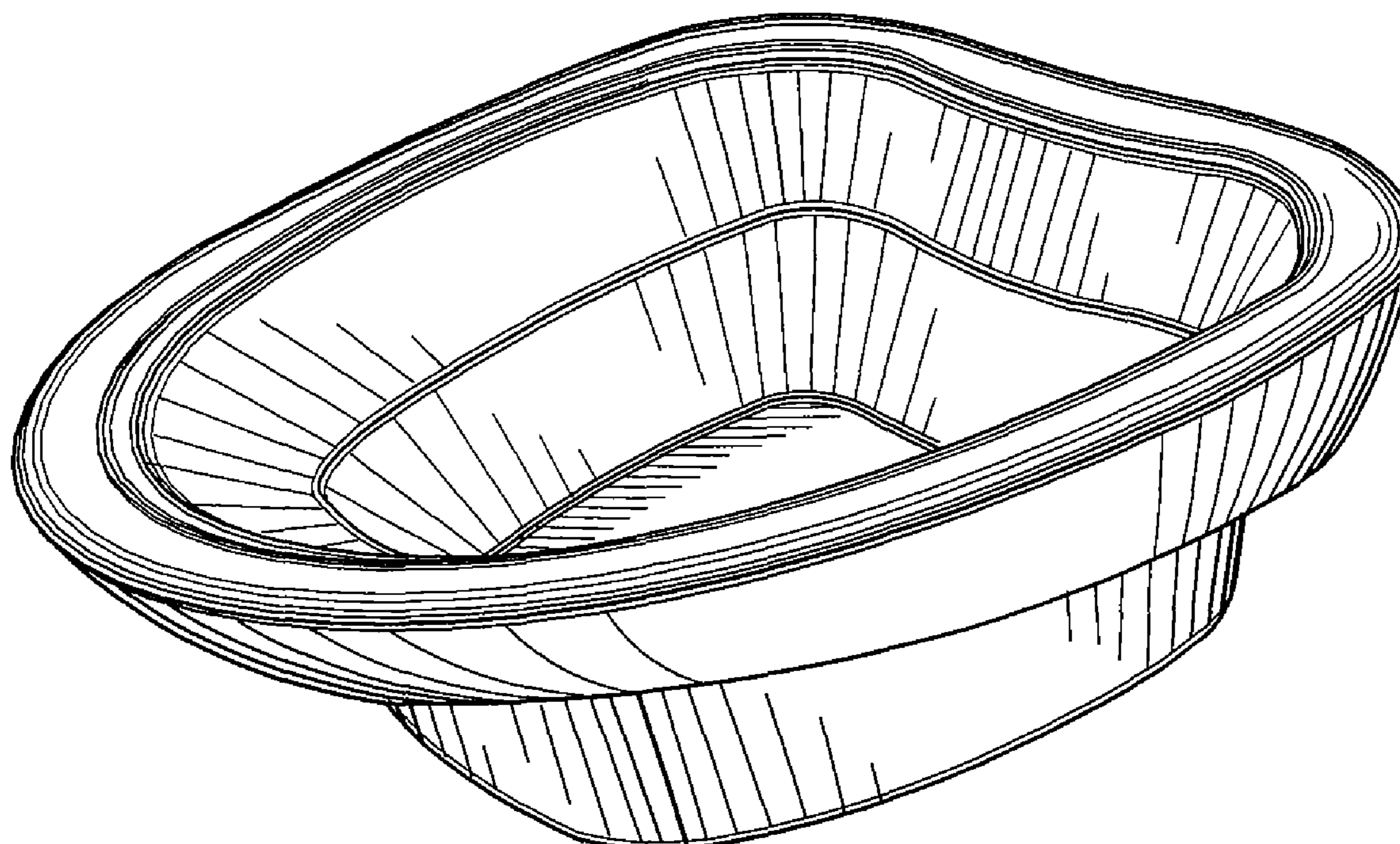

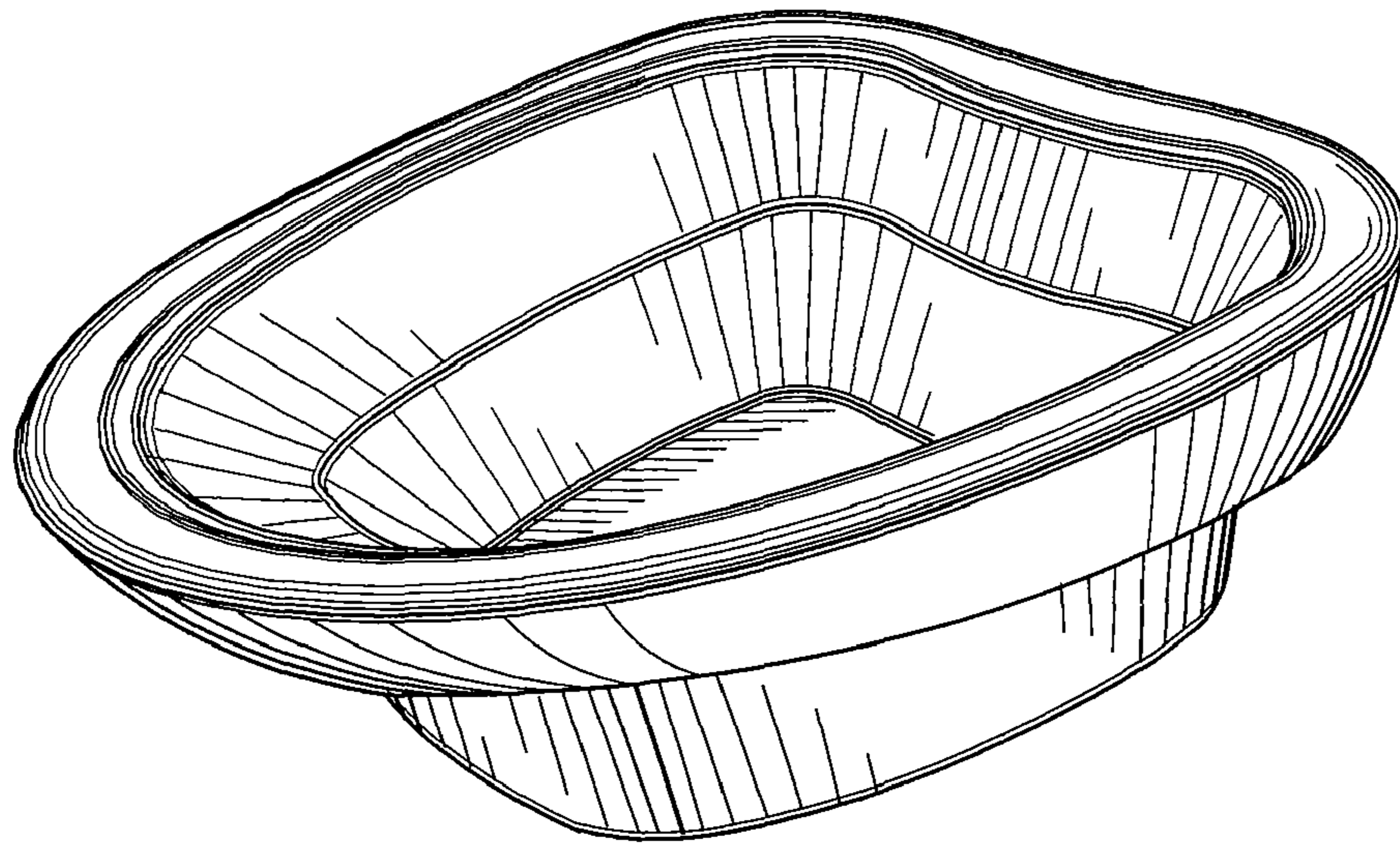

FIG. 1

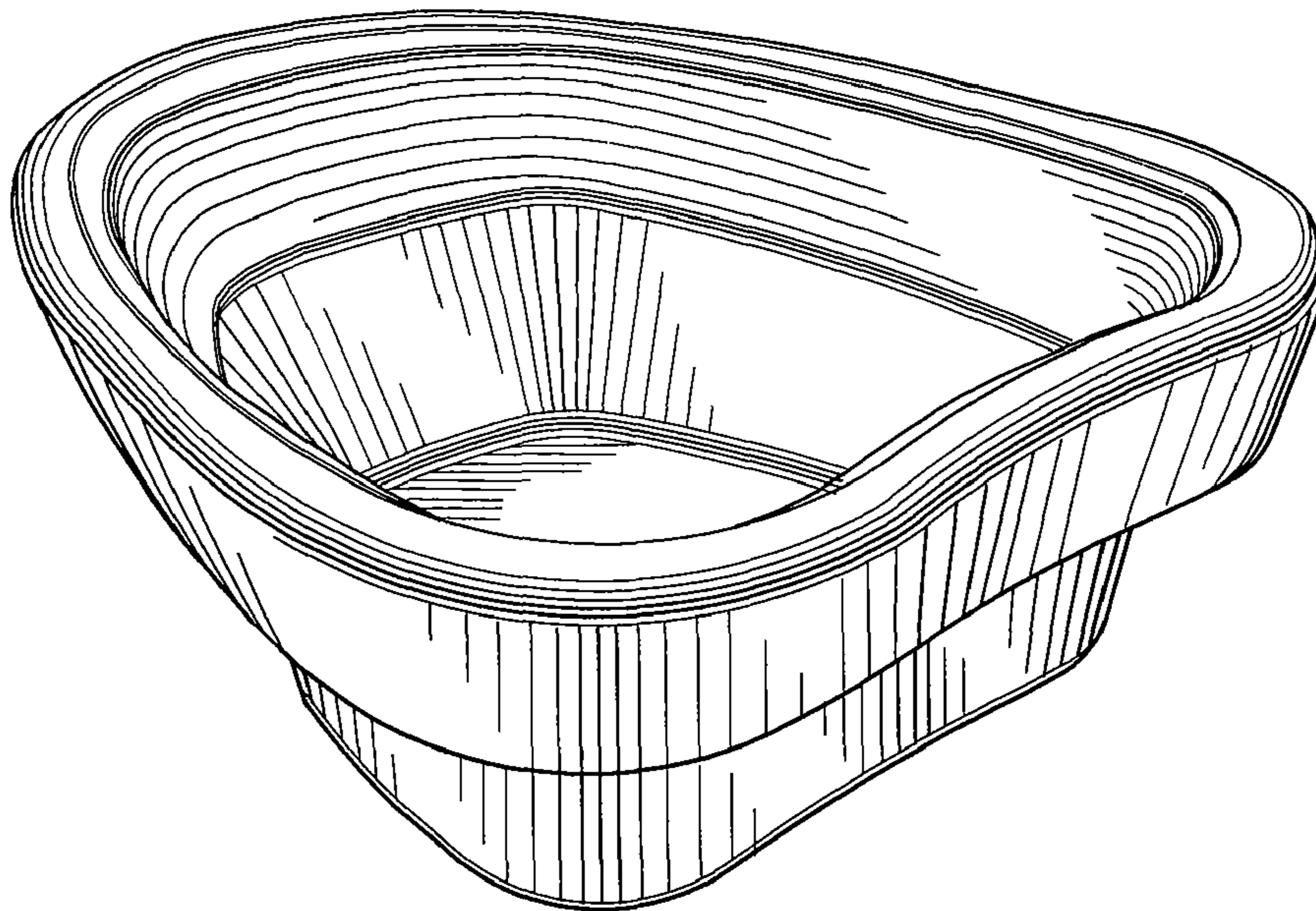

FIG. 2

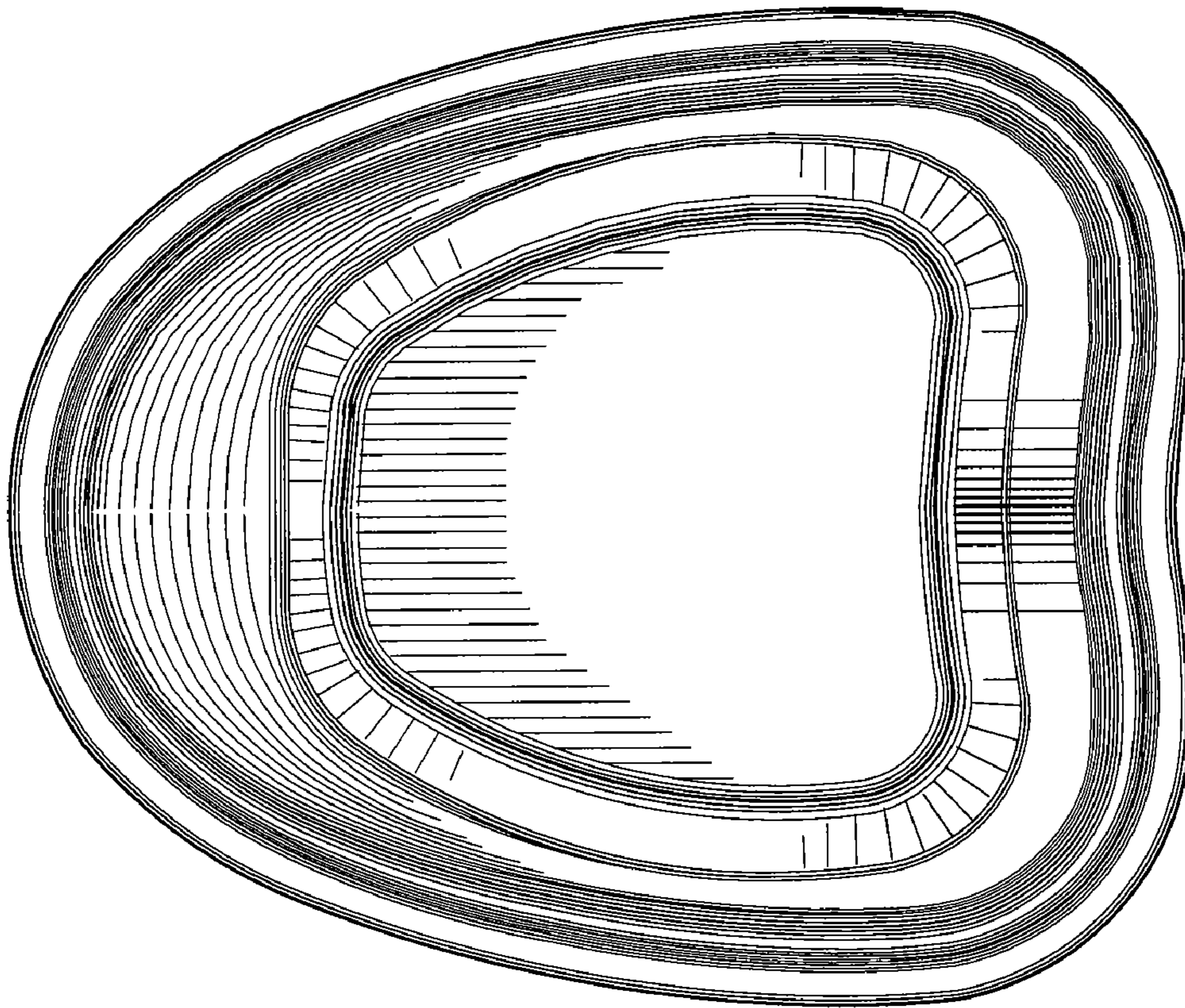

FIG.3

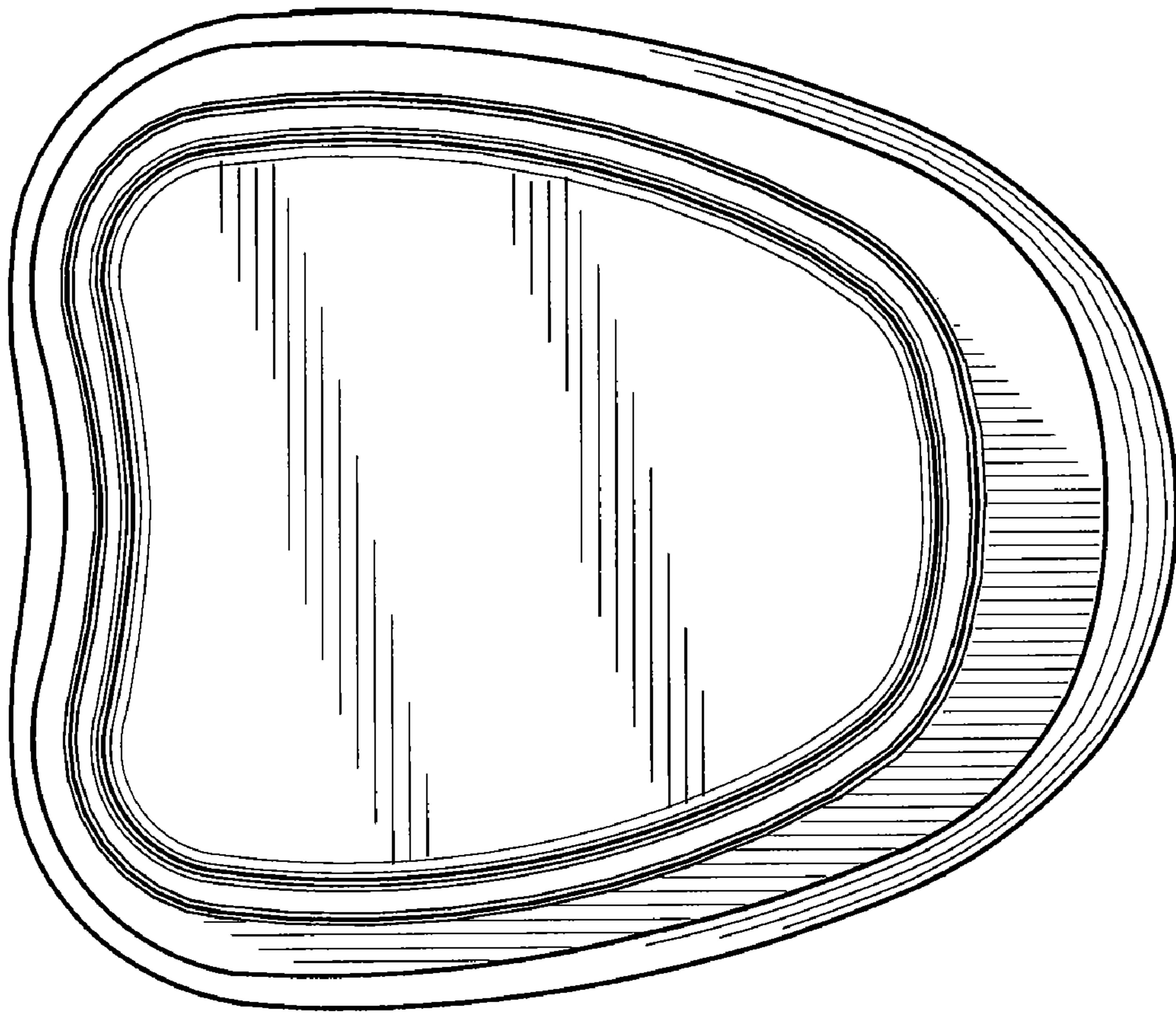

FIG.4

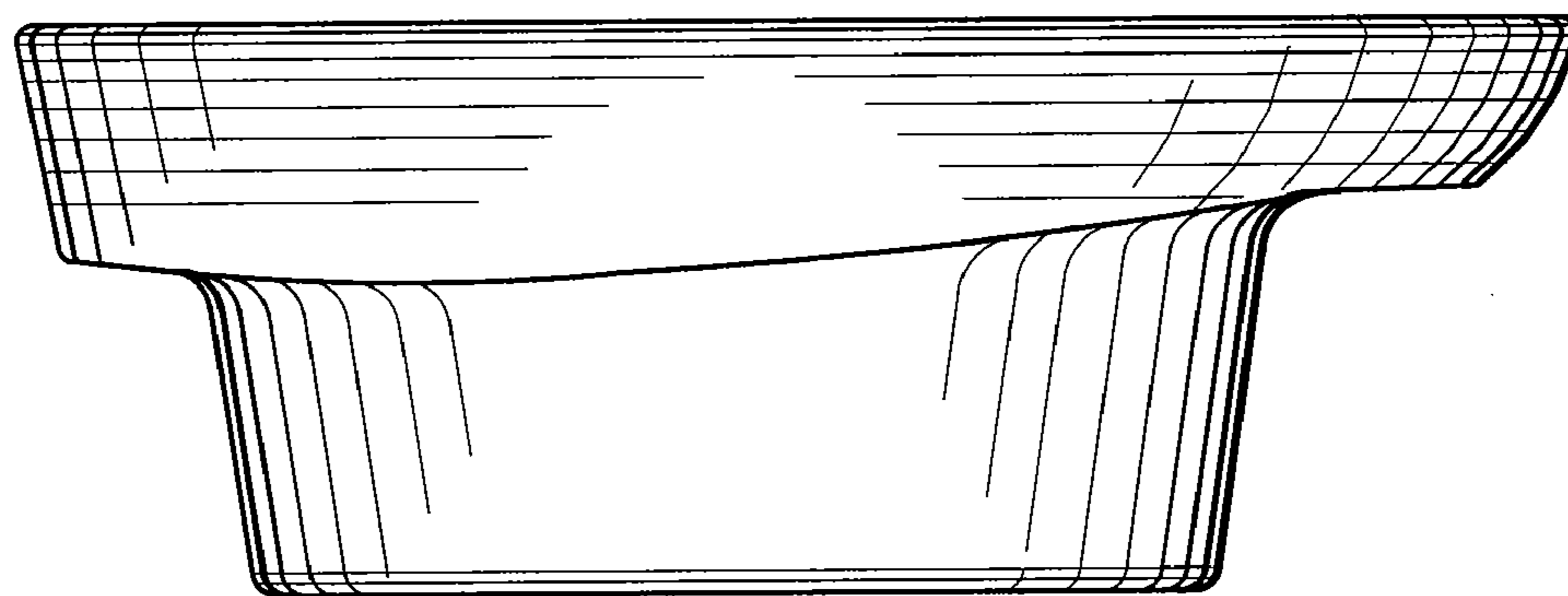

FIG. 5

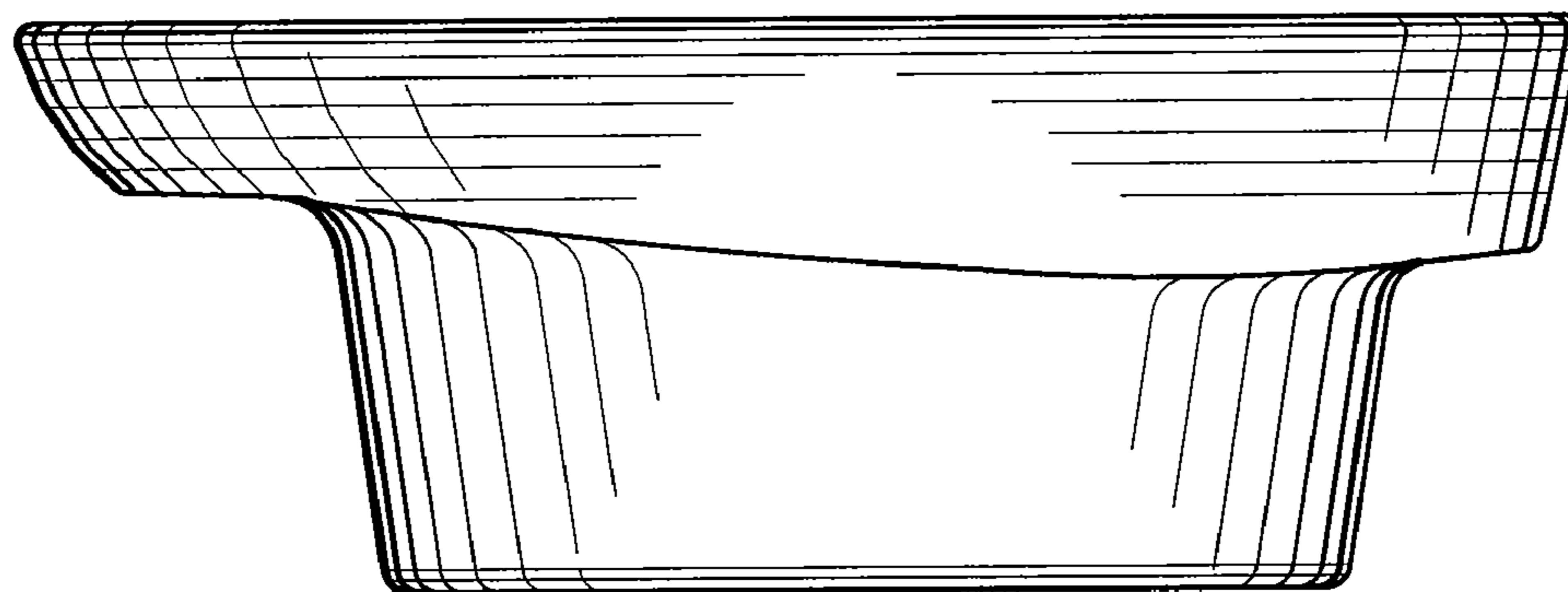

FIG. 6

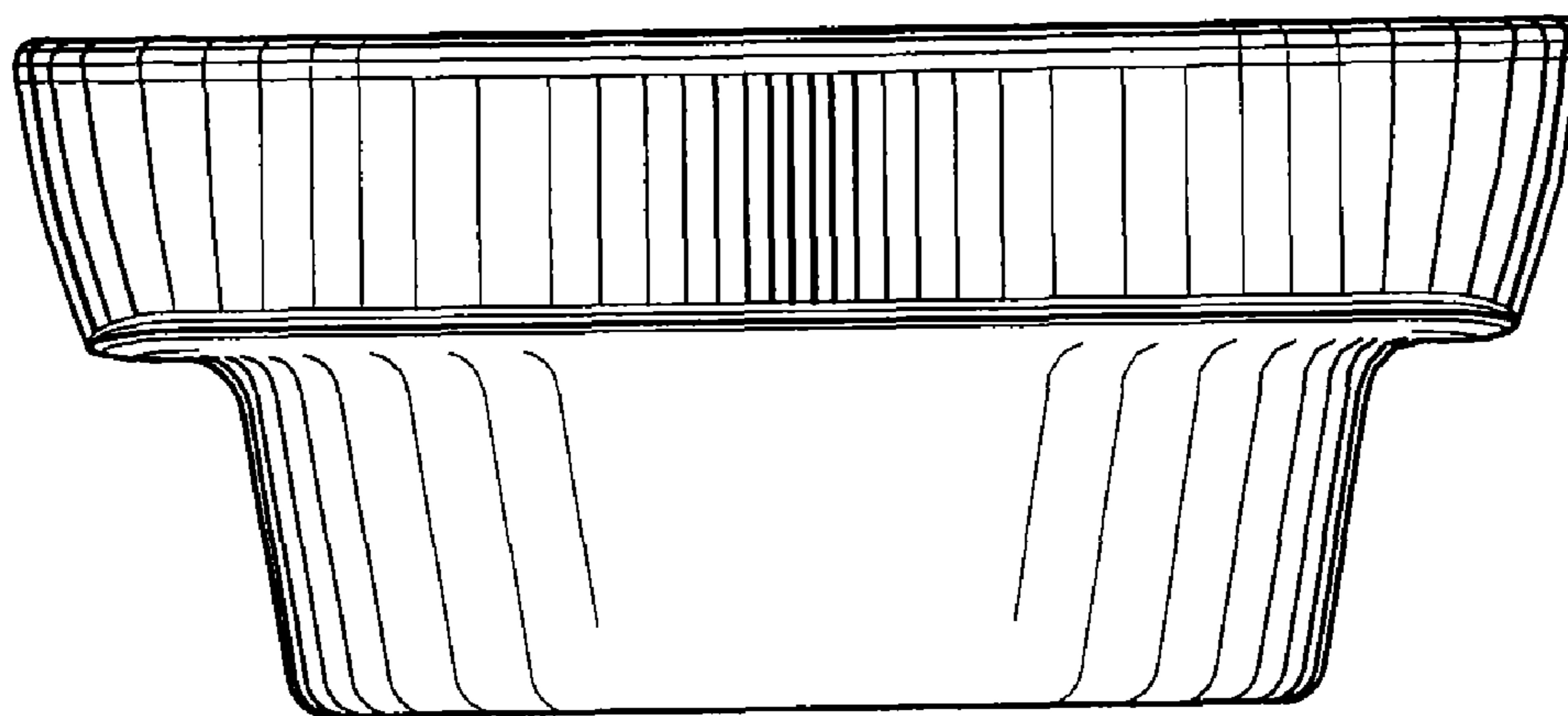

FIG. 7

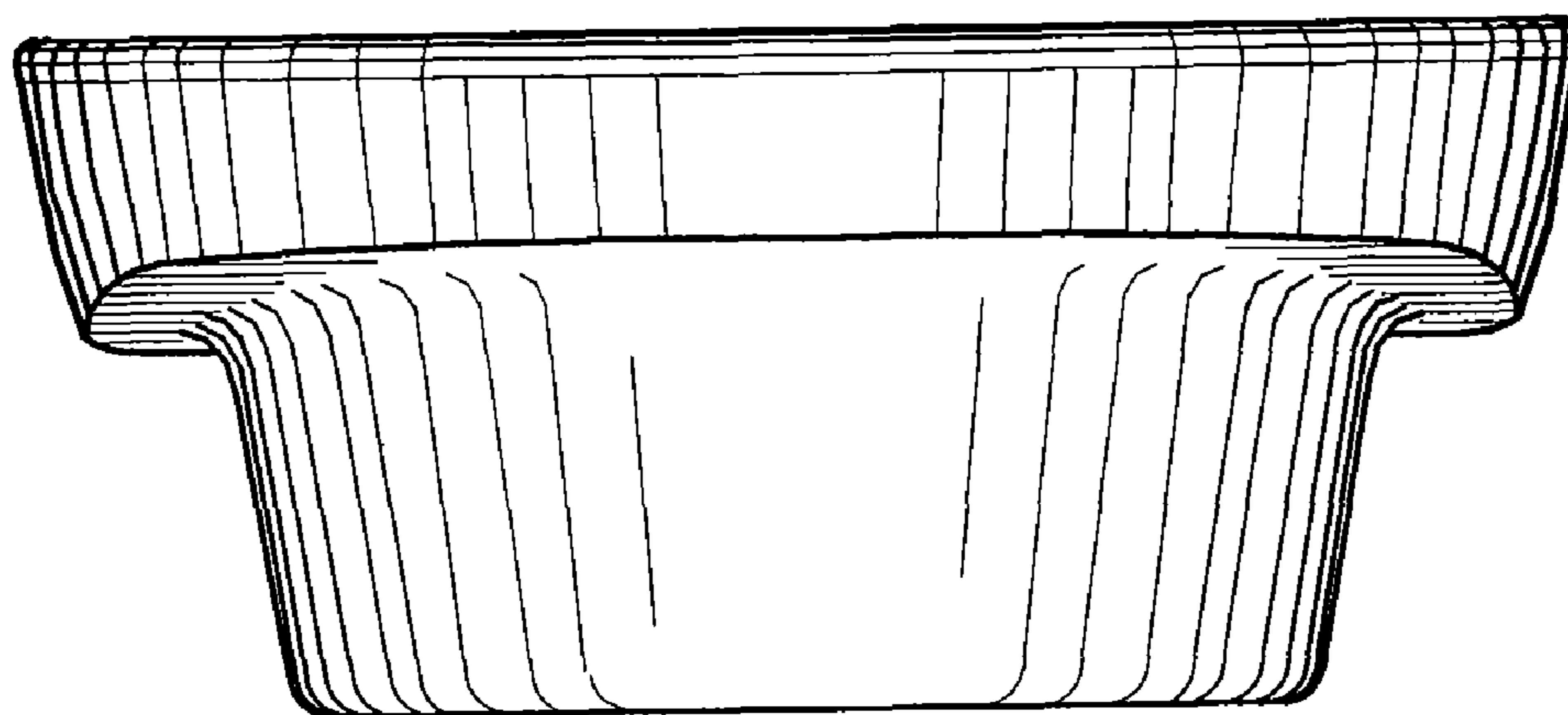

FIG. 8

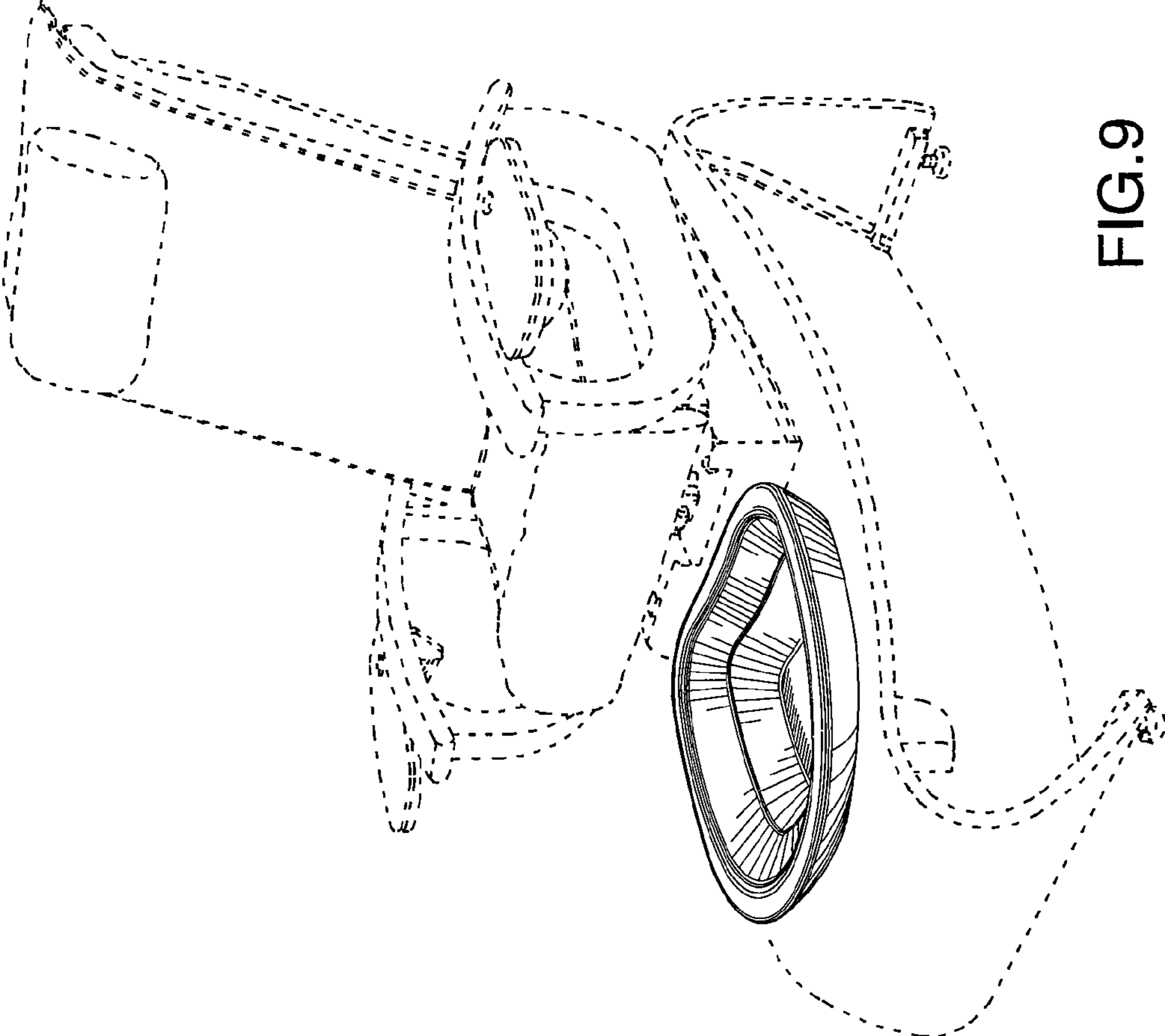

FIG.9