



US00D632750S

(12) **United States Design Patent**
Callowhill et al.

(10) **Patent No.:** **US D632,750 S**

(45) **Date of Patent:** **** Feb. 15, 2011**

(54) **GOLF TRAINING AID**

(75) Inventors: **Jonathan Alfred Callowhill**, Hamilton (CA); **Scott McPherson Chisholm**, Ancaster (CA)

(73) Assignee: **Compression Board Inc.**, Ontario (CA)

(**) Term: **14 Years**

(21) Appl. No.: **29/356,475**

(22) Filed: **Feb. 26, 2010**

(51) **LOC (9) Cl.** **21-02**

(52) **U.S. Cl.** **D21/791; D21/792**

(58) **Field of Classification Search** D21/789, D21/791, 792; 473/150, 162, 168, 218, 273, 473/278

See application file for complete search history.

(56) **References Cited**

U.S. PATENT DOCUMENTS

D331,437 S	12/1992	Wood	
D338,940 S *	8/1993	Pellington	D21/792
5,275,570 A *	1/1994	Hicks	473/273
5,478,081 A	12/1995	Terry	
D366,302 S *	1/1996	Marsh et al.	D21/792
D372,288 S *	7/1996	Deics	D21/791
D397,395 S	8/1998	Massey	
D397,754 S *	9/1998	Nguyen	D21/791
D436,639 S *	1/2001	Haliyo	D21/791
D508,547 S *	8/2005	Llewellyn	D21/791
D524,893 S	7/2006	Rinaldi	

D535,345 S *	1/2007	Davis et al.	D21/792
D550,319 S *	9/2007	Peterson	D21/791
7,614,961 B2	11/2009	Schmutz	

* cited by examiner

Primary Examiner—Mitchell I Siegel

(74) *Attorney, Agent, or Firm*—Bereskin and Parr LLP/S.E.N.C.R.L., s.r.l.

(57) **CLAIM**

The ornamental design for a golf training aid, as shown and described.

DESCRIPTION

FIG. 1 is a top view of a golf training aid according to a first variant of our new design;

FIG. 2 is a perspective view of the golf training aid of FIG. 1;

FIG. 3 is a perspective view of the golf training aid of FIG. 1 in use;

FIG. 4 is a top view of a golf training aid according to a second variant;

FIG. 5 is a top view of a golf training aid according to a third variant;

FIG. 6 is a top view of a golf training aid according to a fourth variant; and,

FIG. 7 is a top view of a golf training aid according to a fifth variant.

The broken line showing is included for the purpose of illustrating and forms no part of the claimed design.

1 Claim, 4 Drawing Sheets

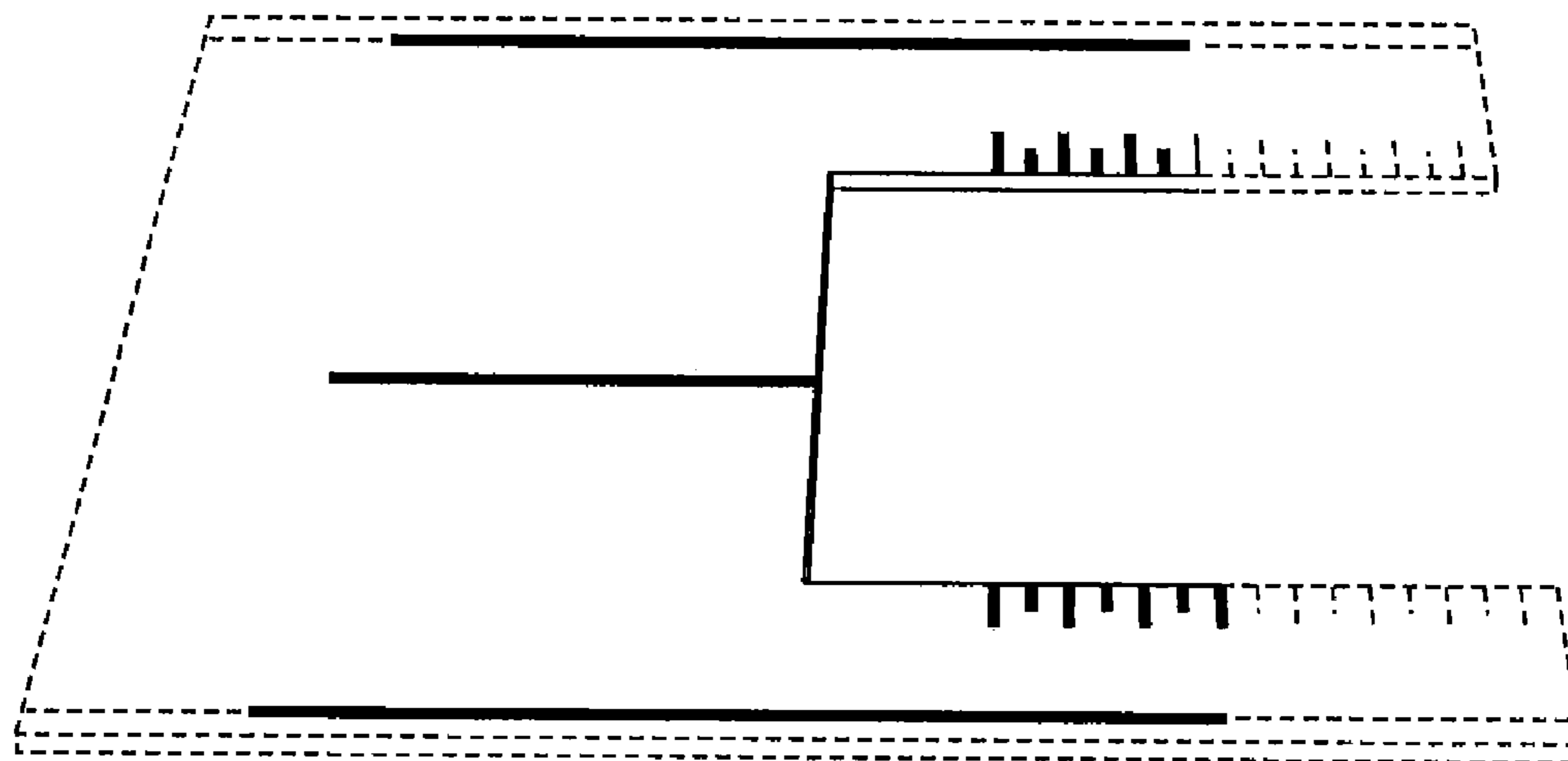

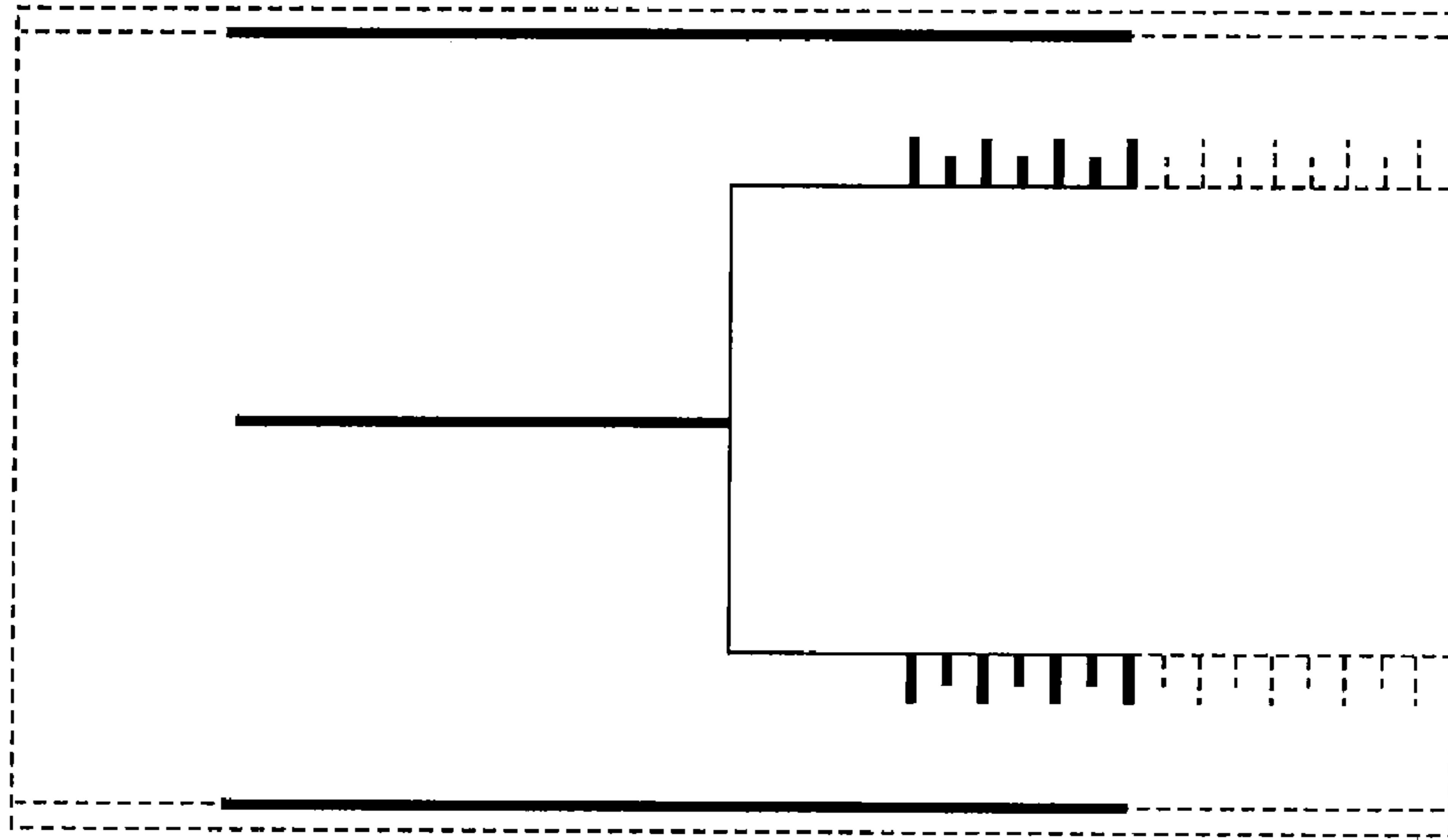

FIG. 1

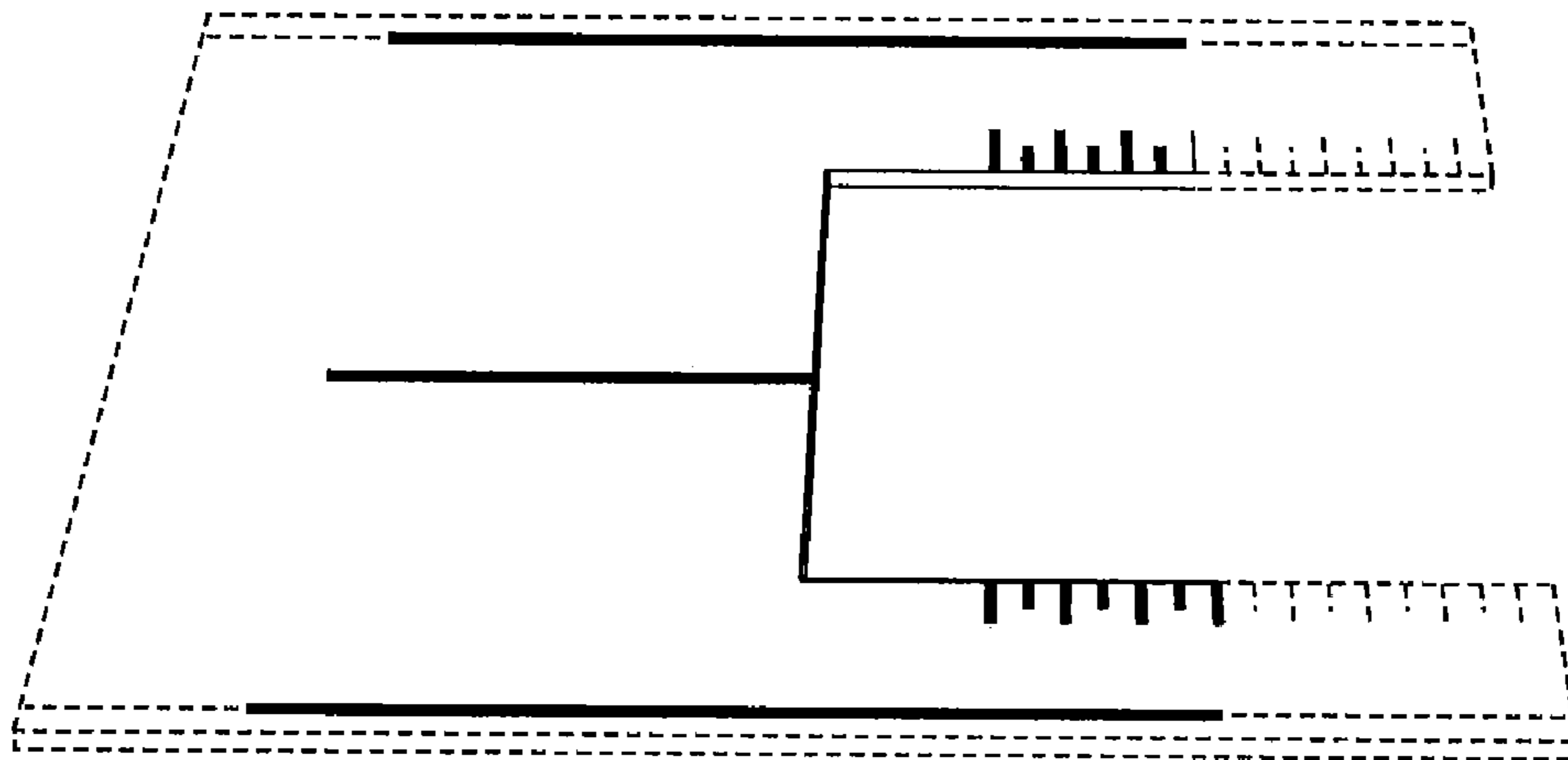

FIG. 2

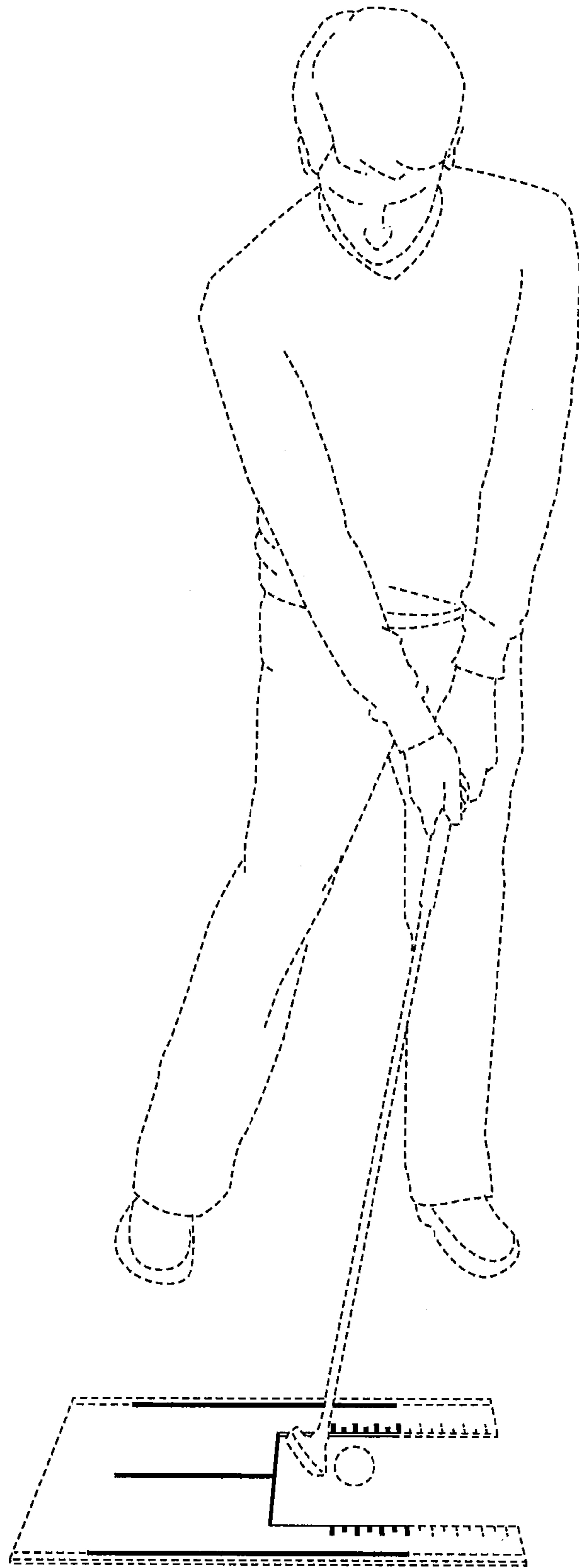

FIG. 3

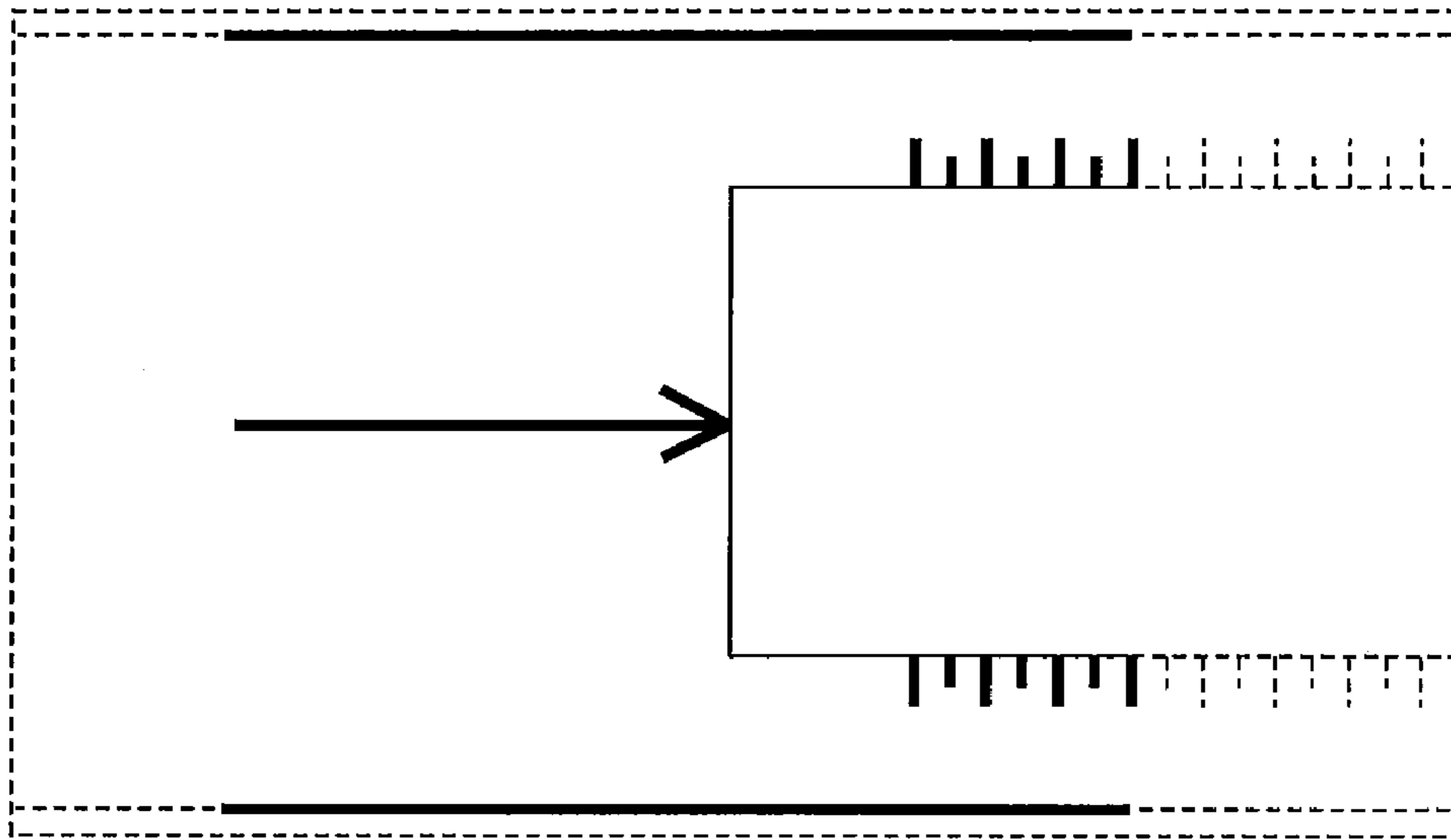

FIG. 4

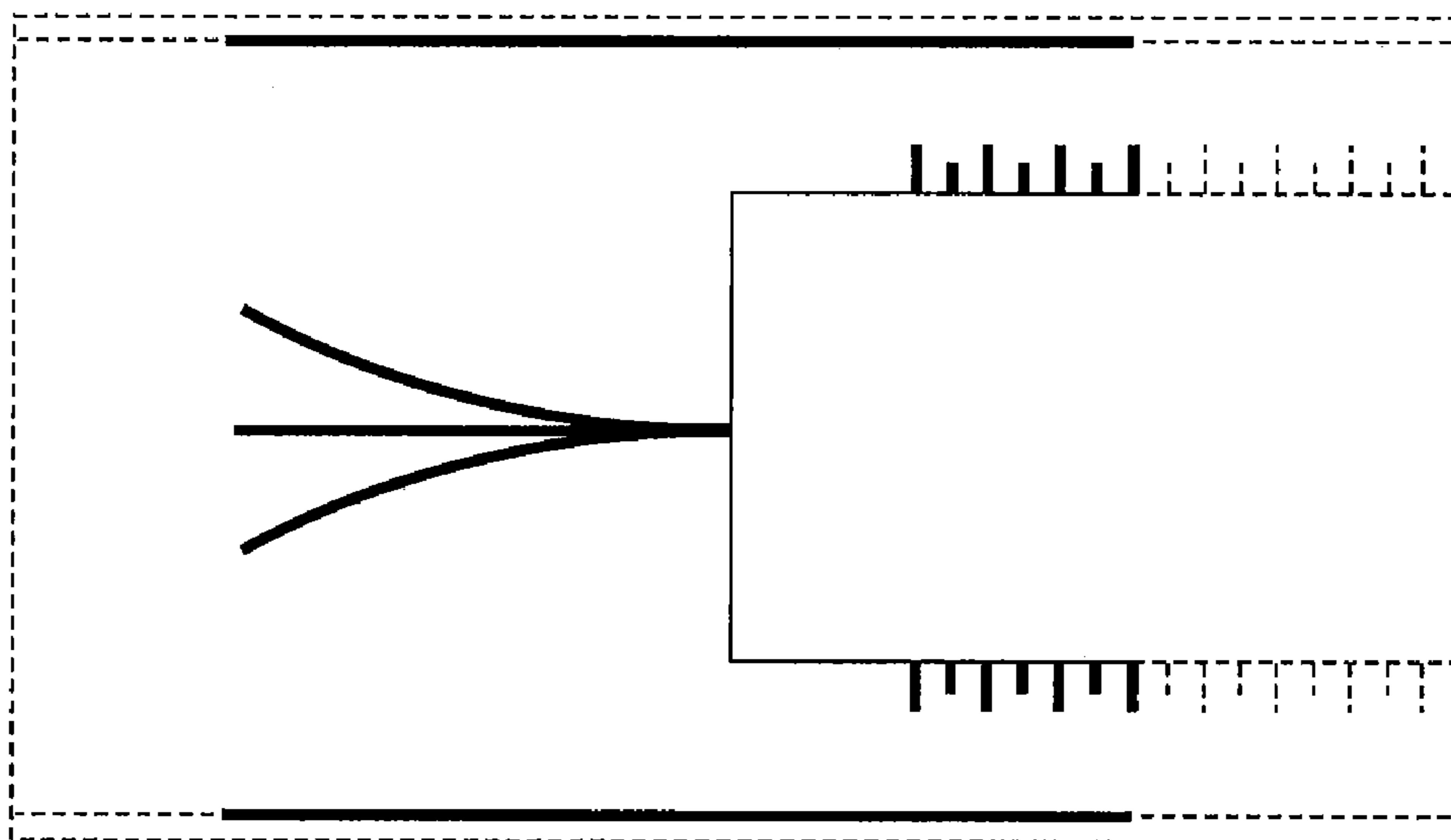

FIG. 5

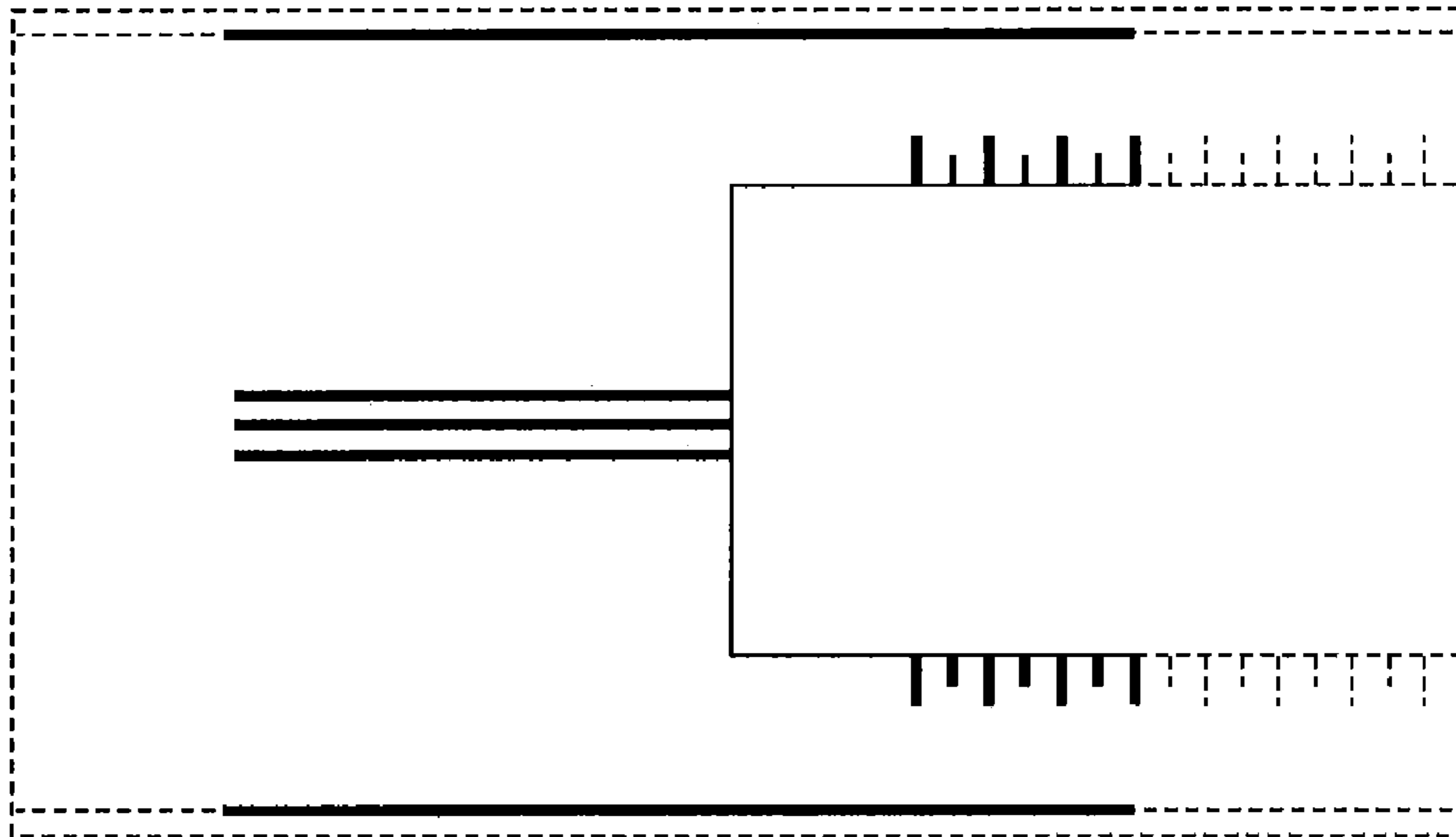

FIG. 6

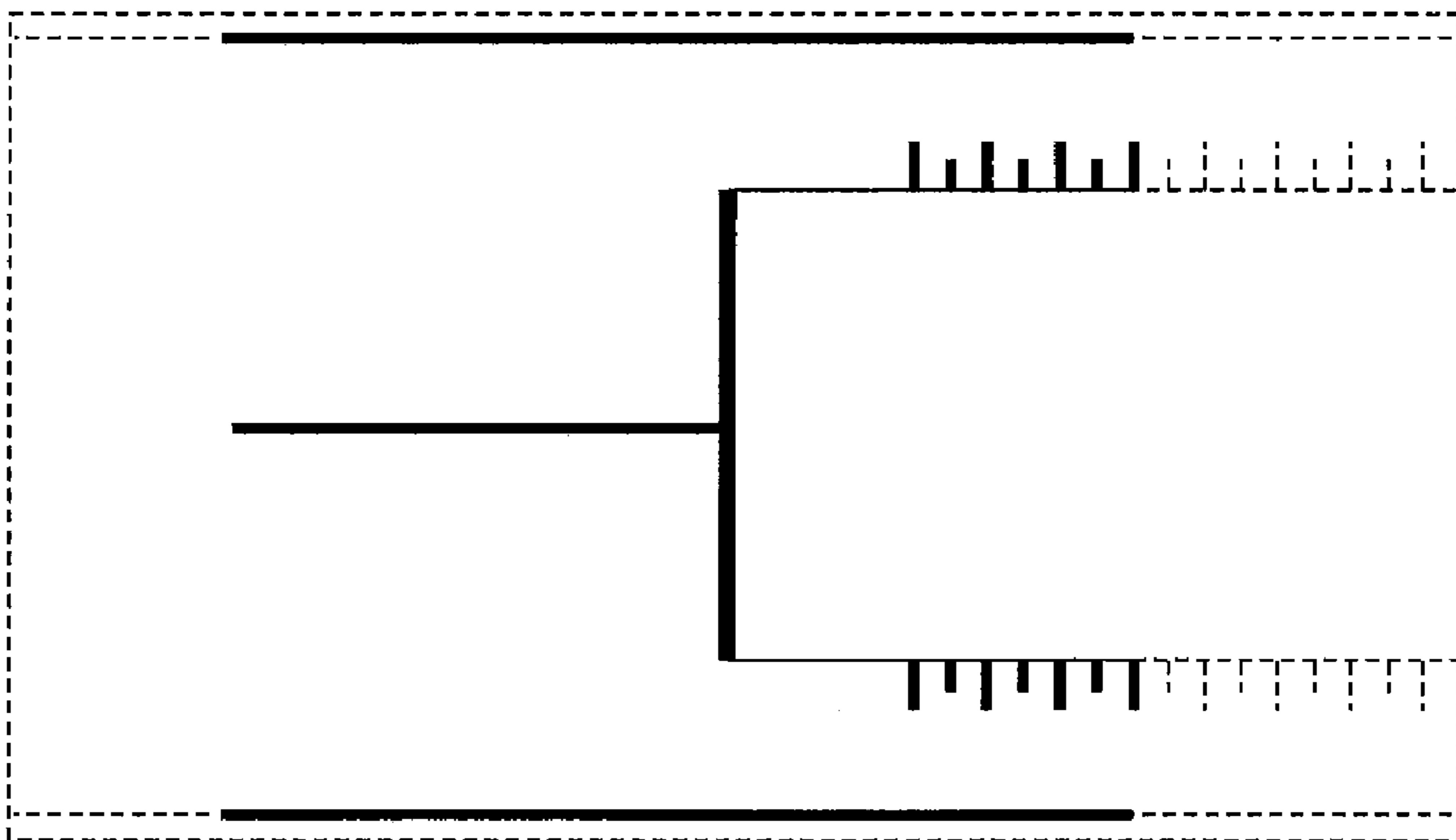

FIG. 7