



US00D632729S

(12) **United States Design Patent**
Goad

(10) **Patent No.:** **US D632,729 S**
(45) **Date of Patent:** **** Feb. 15, 2011**

(54) **GUITAR PICK**

(76) Inventor: **Bradley C. Goad**, 3154 Comber Ct.
NE., Salem, OR (US) 97305

(**) Term: **14 Years**

(21) Appl. No.: **29/353,590**

(22) Filed: **Jan. 11, 2010**

(51) **LOC (9) Cl.** **17-03**

(52) **U.S. Cl.** **D17/20**

(58) **Field of Classification Search** D17/18,
D17/19, 20, 99; 84/322, 320, 321, 315, 8,
84/97, 99, 106, 258, 422.3, 453; 984/123

See application file for complete search history.

(56) **References Cited**

U.S. PATENT DOCUMENTS

2,221,234	A *	11/1940	Frasier	84/322
2,449,890	A	9/1948	Garlick	
2,776,592	A *	1/1957	Di Preta	84/322
3,312,137	A *	4/1967	Oddo	84/322
3,442,169	A *	5/1969	Bowers	84/322
3,699,838	A	10/1972	Montgomery	
3,789,720	A	2/1974	McIntyre	
4,020,732	A *	5/1977	Kelly	84/322
D257,151	S *	9/1980	Burke	D17/20
4,270,433	A *	6/1981	Adamec	84/322
4,395,932	A *	8/1983	Mills	84/322
4,398,444	A *	8/1983	Walker	84/322
4,497,237	A	2/1985	Beall	
4,651,614	A *	3/1987	Cavallo	84/322
D291,809	S *	9/1987	Jasper	D17/20
4,867,032	A *	9/1989	Lukehart	84/322
4,993,301	A	2/1991	de los Santos	
D336,102	S *	6/1993	Hodesh	D17/20
5,253,562	A *	10/1993	Kline	84/322
D346,177	S *	4/1994	Reineck	D17/20
5,341,715	A	8/1994	Hucek	
D358,833	S *	5/1995	Ridley et al.	D17/20
D369,615	S *	5/1996	Latteri	D17/20
5,587,542	A	12/1996	Everly	
5,973,243	A	10/1999	Christenson	
6,054,643	A	4/2000	Chance et al.	

D441,005	S *	4/2001	Parham, Jr.	D17/20
6,342,661	B1	1/2002	Flamm	
6,417,431	B1	7/2002	Wilkinson	
6,777,602	B2	8/2004	Hautamaki et al.	
6,835,881	B1	12/2004	Jackson	
6,949,700	B1	9/2005	Kelly	
7,256,337	B1 *	8/2007	Walker	84/327
D557,330	S	12/2007	Parikh	
D561,237	S *	2/2008	Morris	D17/20
7,371,950	B2 *	5/2008	Benyahia et al.	84/320
D577,379	S *	9/2008	Morris	D17/20
D579,552	S *	10/2008	Oldenburg et al.	D24/110.6
7,589,267	B1 *	9/2009	Sims	84/320
D603,449	S *	11/2009	Whetstone	D17/20
D607,920	S *	1/2010	Bartel	D17/20
2002/0178891	A1	12/2002	Atkin	
2005/0204893	A1	9/2005	Luschniu	
2007/0256533	A1	11/2007	Newmaster	
2008/0110319	A1 *	5/2008	Morris	84/320

(Continued)

Primary Examiner—Mark A Goodwin
(74) *Attorney, Agent, or Firm*—Peter A Haas, Esquire LLC

(57) **CLAIM**

The ornamental design for a guitar pick, as shown and described.

DESCRIPTION

FIG. 1 is a front elevation view of a guitar pick showing my new design;
FIG. 2 is a left side elevation view thereof;
FIG. 3 is a right side elevation view thereof;
FIG. 4 is a top plan view thereof;
FIG. 5 is a bottom plan view thereof; and,
FIG. 6 is an off-set right side perspective view thereof.

1 Claim, 1 Drawing Sheet

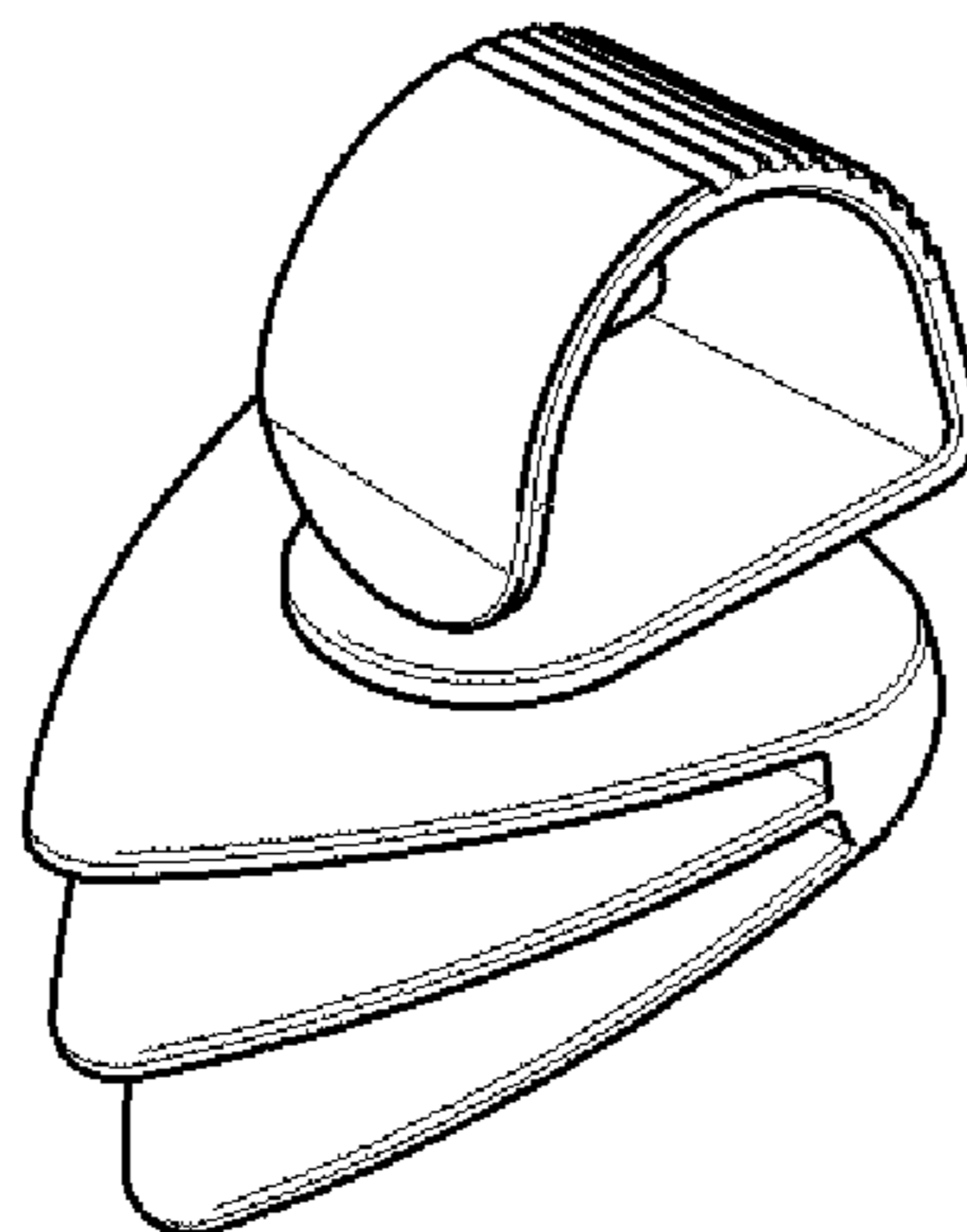

US D632,729 S

Page 2

U.S. PATENT DOCUMENTS	2009/0084244 A1*	4/2009	Goad	84/320	
2008/0163737 A1*	7/2008	Grant	84/320		
2009/0056521 A1*	3/2009	Goad	84/320		* cited by examiner

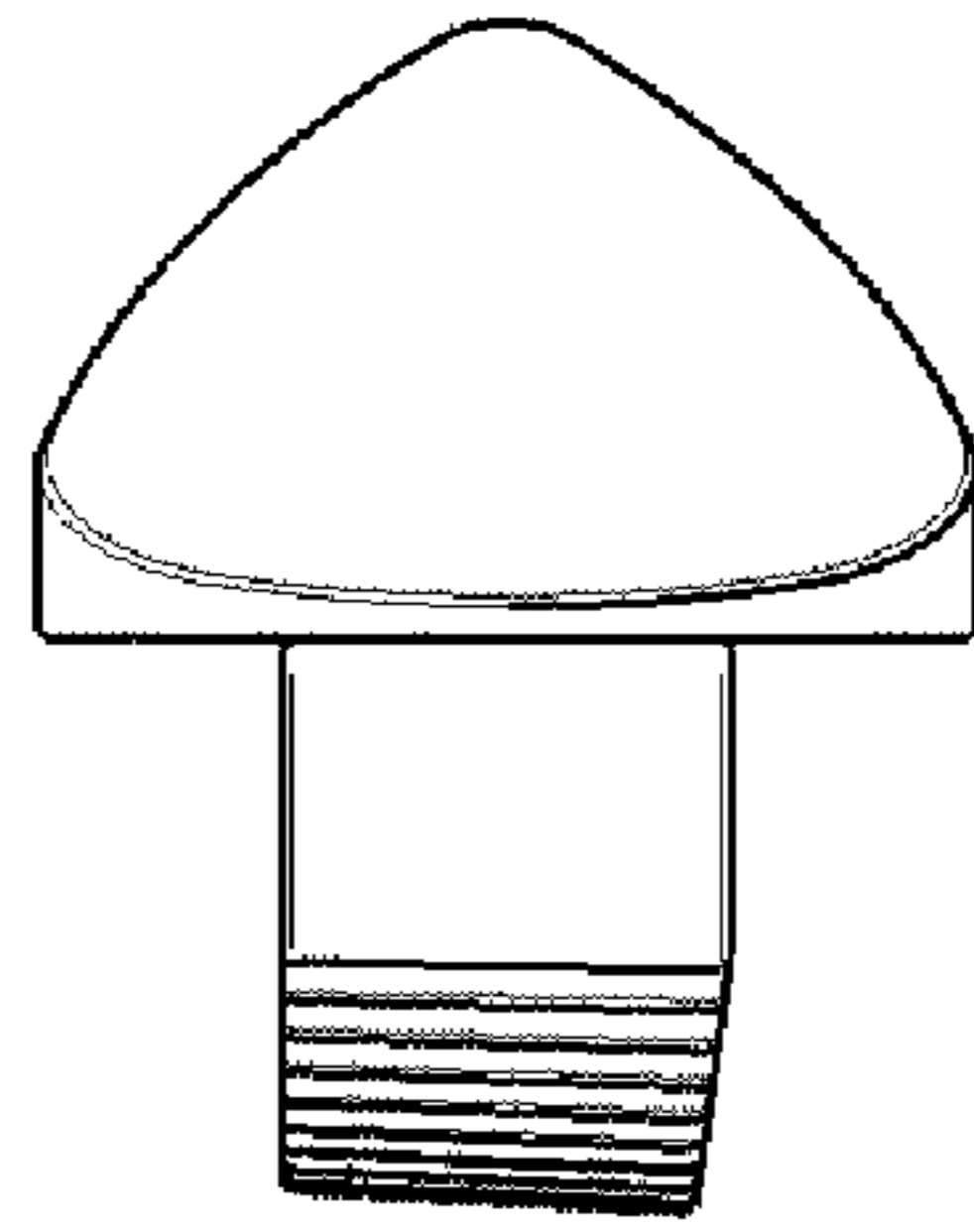

FIG. 4

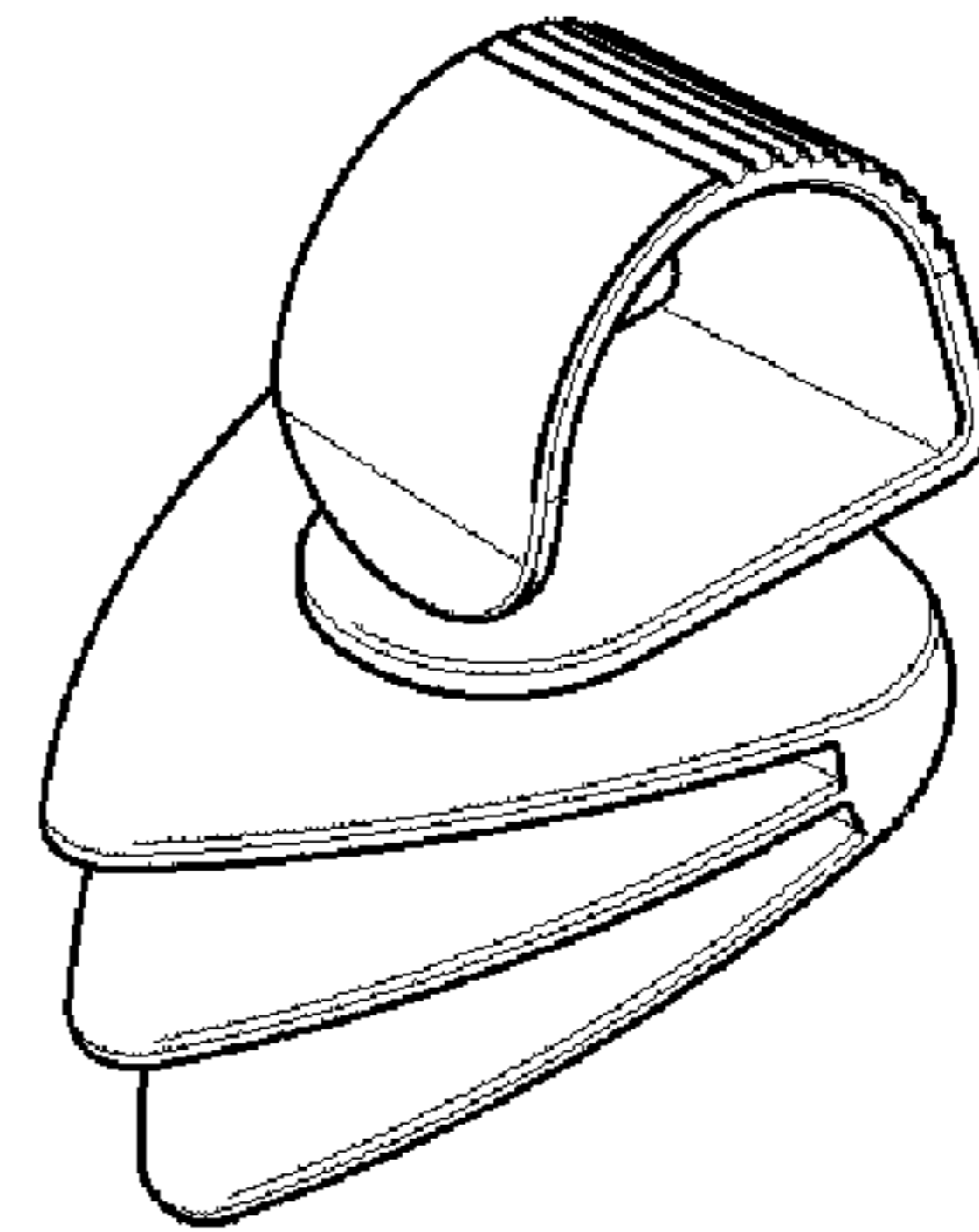

FIG. 6

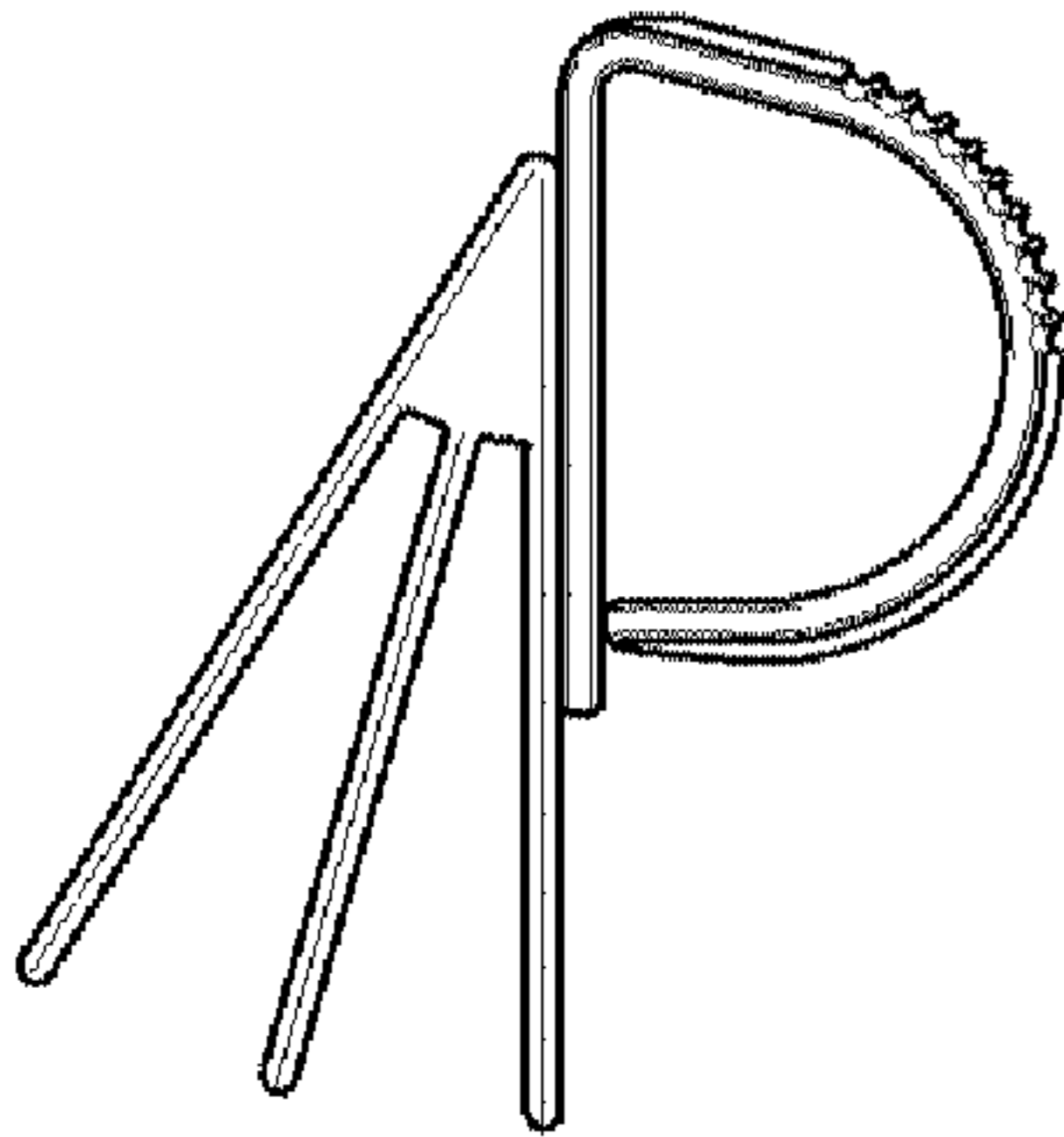

FIG. 2

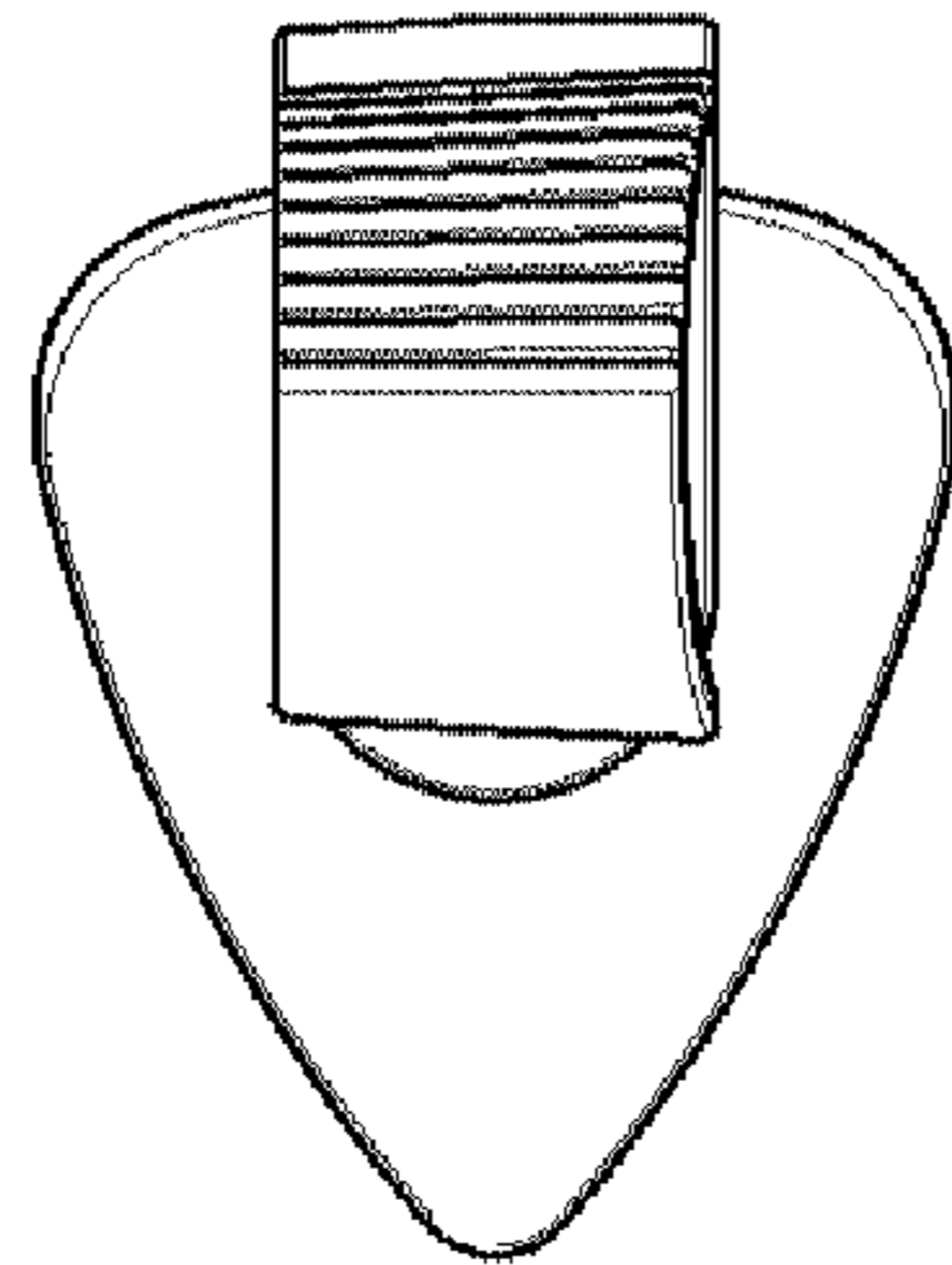

FIG. 1

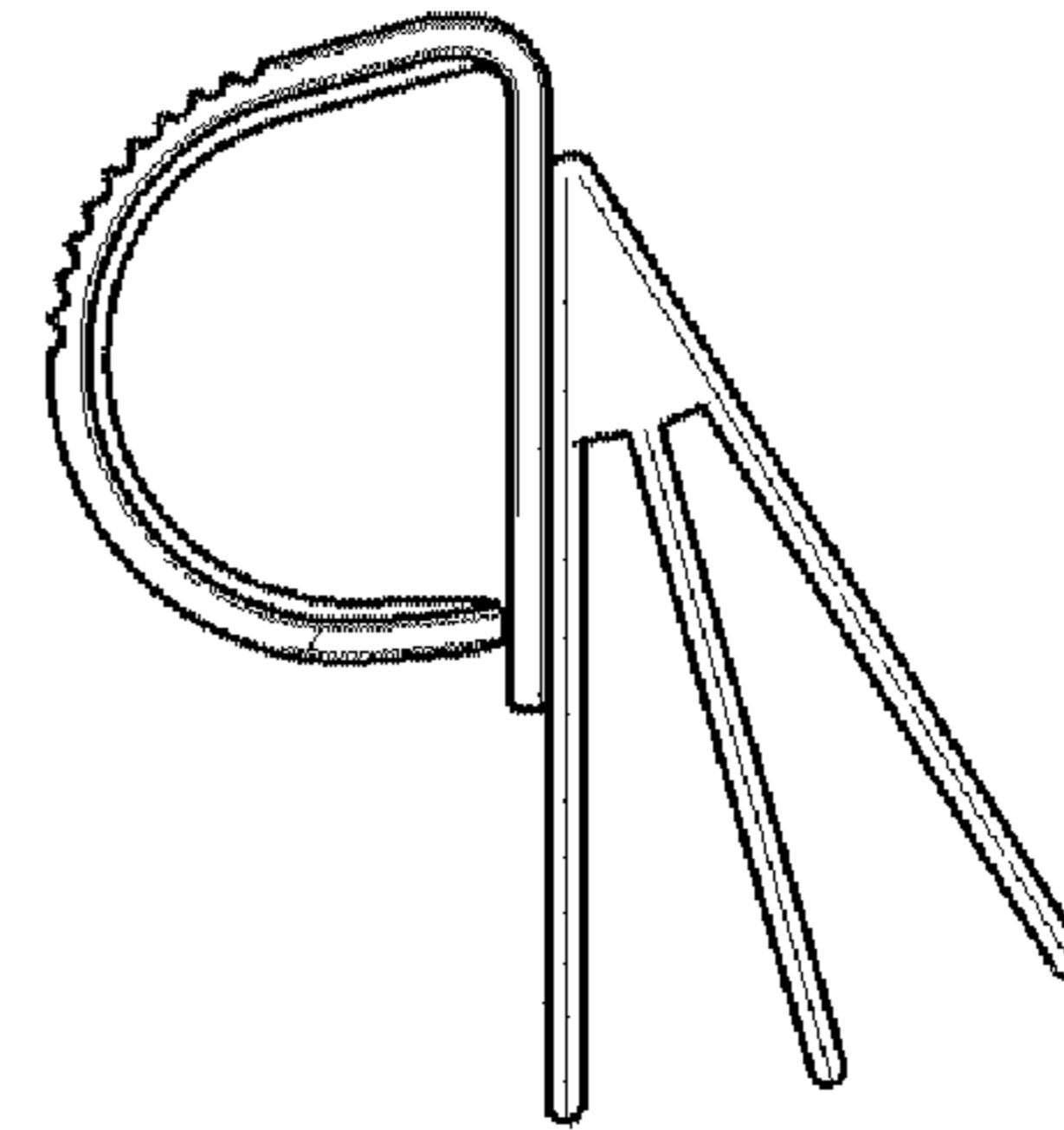

FIG. 3

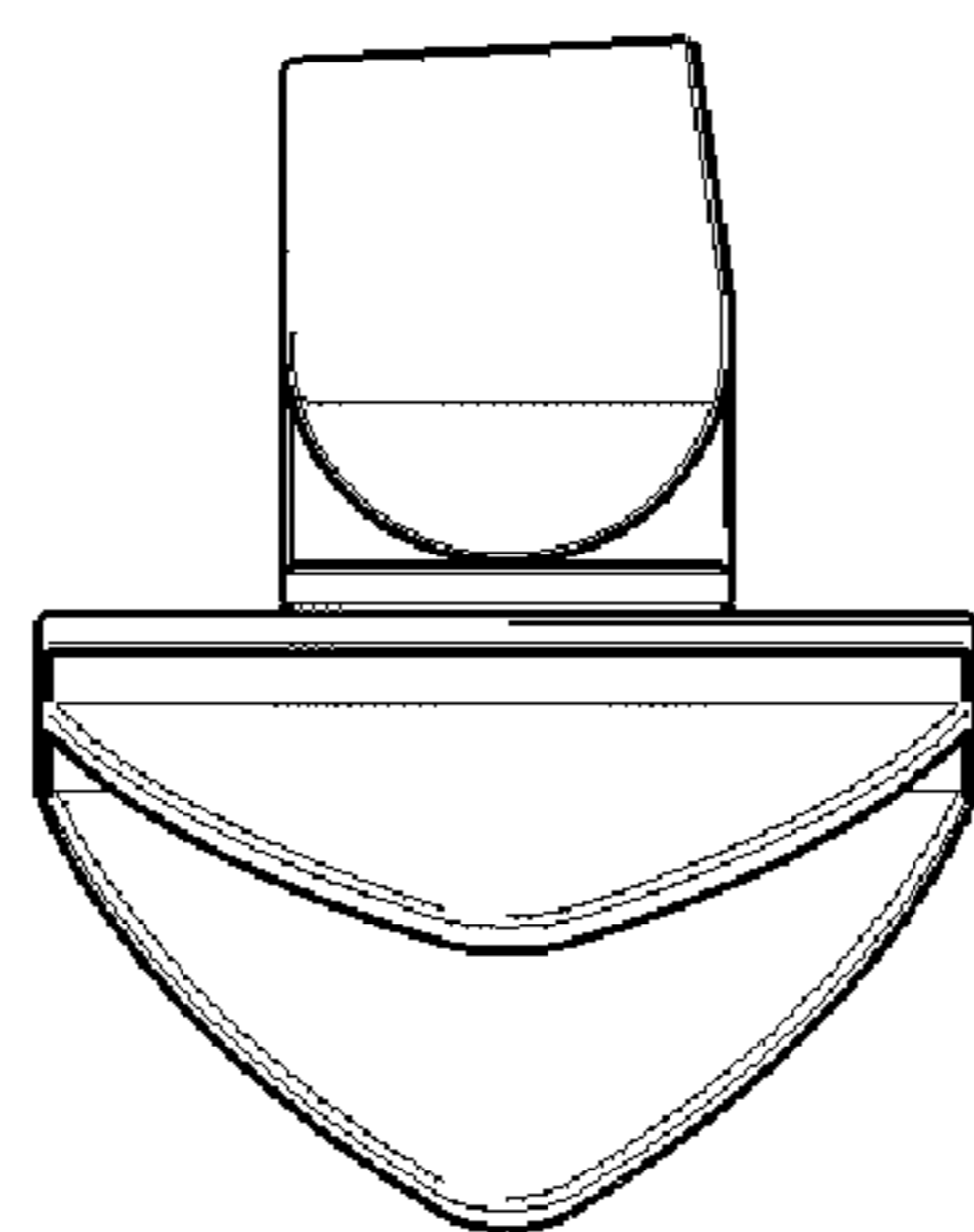

FIG. 5