



US00D632710S

(12) **United States Design Patent**
Brown et al.

(10) **Patent No.:** **US D632,710 S**
(45) **Date of Patent:** **** Feb. 15, 2011**

(54) **MACHINE FOR CUTTING A WINDOW COVERING**

6,140,606 A * 10/2000 Heikilla et al. 219/121.82

(75) Inventors: **Paul Christopher Brown**, Elgin, SC (US); **Brian Bellamy Johnson**, Atlanta, GA (US); **Neil John Varlamoff**, Acworth, GA (US)

(Continued)

OTHER PUBLICATIONS

(73) Assignee: **Newell Window Furnishings, Inc.**, High Pointe, NC (US)

U.S. Appl. No. 12/579,897, filed Oct. 15, 2009.

(Continued)

(**) Term: **14 Years**

Primary Examiner—Patricia Palasik

(21) Appl. No.: **29/366,056**

(74) *Attorney, Agent, or Firm*—Dennis J. Williamson; Moore & Van Allen, PLLC

(22) Filed: **Jul. 19, 2010**

(57) **CLAIM**

(51) **LOC (9) Cl.** **15-09**

We claim the ornamental design for a machine for cutting a window covering, as shown and described.

(52) **U.S. Cl.** **D15/127**

(58) **Field of Classification Search** D15/122, D15/127; D18/38, 39, 53, 54, 55; 29/24.5, 29/560; 83/13, 76.1, 76.8, 100, 167, 196, 83/197, 198, 453, 468.2, 522.19, 859, 929

DESCRIPTION

See application file for complete search history.

(56) **References Cited**

FIG. 1 is a perspective view showing an embodiment of our new design for a machine for cutting a window covering;

U.S. PATENT DOCUMENTS

FIG. 2 is a front view showing our new design shown in FIG. 1;

2,789,639 A	4/1957	Lorentzen	
4,589,312 A	5/1986	Meyers et al.	
4,589,313 A	5/1986	Meyers et al.	
4,730,372 A	3/1988	Tsuchida	
4,819,530 A	4/1989	Huang	
D300,933 S *	5/1989	Gemmani	D15/127
4,907,325 A	3/1990	Hsu	
4,993,131 A	2/1991	Graves et al.	
5,103,702 A	4/1992	Yannazzone	
D331,066 S *	11/1992	Englert	D15/122
5,183,993 A *	2/1993	Sato et al.	219/121.82
D343,626 S *	1/1994	Fan	D15/127
5,339,716 A	8/1994	Sands et al.	
5,456,149 A	10/1995	Elsenheimer et al.	
5,799,557 A	9/1998	Wang	
5,816,126 A	10/1998	Pluber	
6,003,217 A	12/1999	Graves et al.	
6,079,306 A	6/2000	Liu	

FIG. 3 is a back view showing our new design shown in FIG. 1;

FIG. 4 is a top view showing our new design shown in FIG. 1;

FIG. 5 is a bottom view showing our new design shown in FIG. 1;

FIG. 6 is a left side view showing our new design shown in FIG. 1; and,

FIG. 7 is a right side view showing our new design shown in FIG. 1.

The portions shown in broken lines are not part of the claimed design but show the environment in which the design is associated.

1 Claim, 6 Drawing Sheets

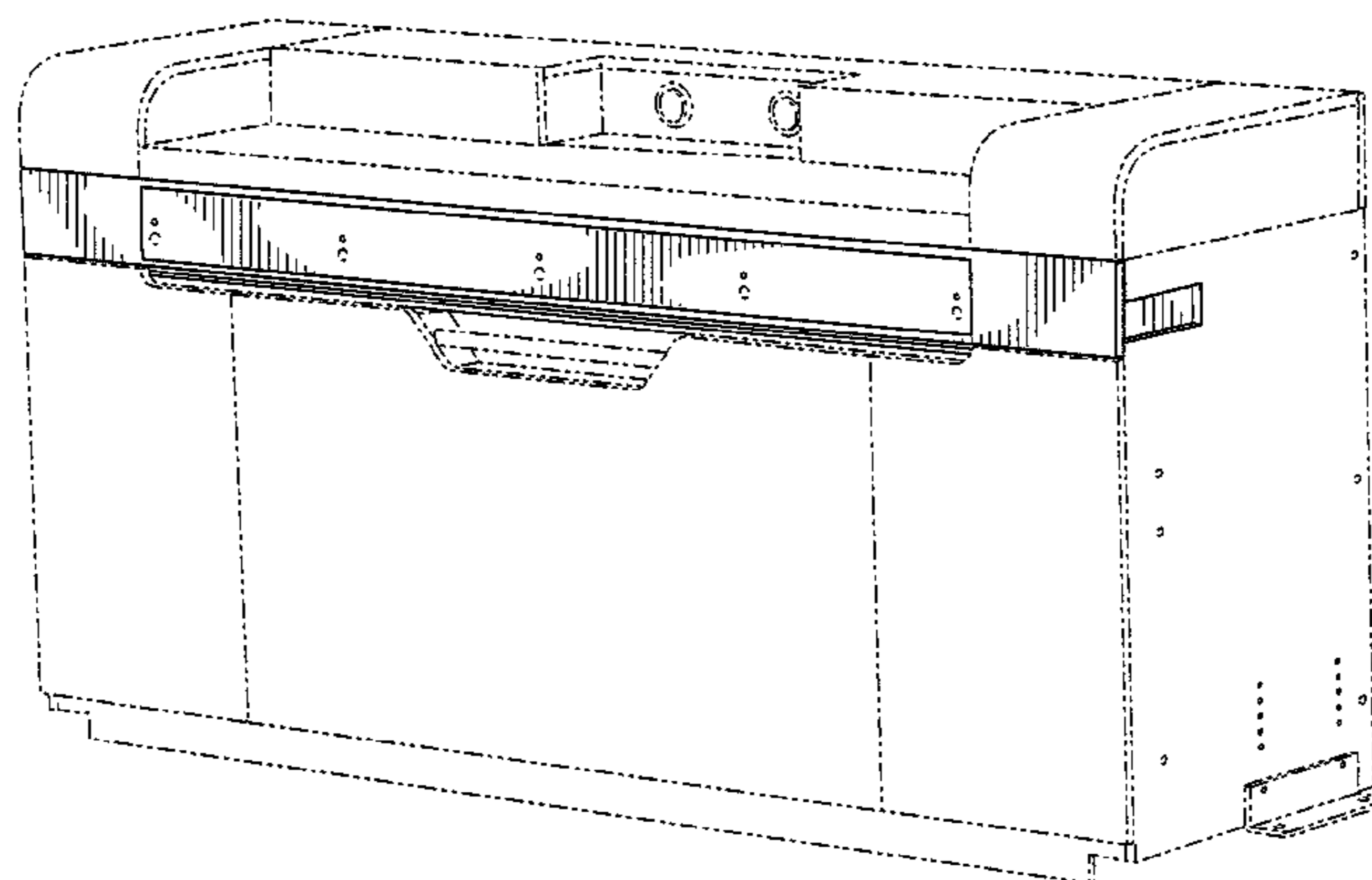

US D632,710 S

Page 2

U.S. PATENT DOCUMENTS

6,240,824 B1 6/2001 Hsu
D445,807 S * 7/2001 Baulk D15/127
6,412,381 B1 7/2002 Wang et al.
6,427,571 B1 8/2002 Hsu
D464,363 S * 10/2002 Saito et al. D15/122
6,604,443 B2 8/2003 Roberts et al.
6,615,698 B2 9/2003 Chuang et al.
D493,808 S * 8/2004 Tanaka et al. D15/199
6,855,911 B1 * 2/2005 Lai 219/121.86
6,945,152 B2 9/2005 Jabbari et al.
6,971,296 B2 12/2005 Lin et al.
6,973,364 B2 12/2005 Schwartz et al.
7,000,516 B2 2/2006 Lin et al.
7,007,576 B2 3/2006 Roberts et al.
D518,497 S * 4/2006 Muraoka et al. D15/199
7,024,977 B2 4/2006 Nien
7,036,412 B2 5/2006 Abdollahzadeh
7,040,205 B2 5/2006 Roberts et al.
7,044,043 B2 5/2006 Cheng
7,069,832 B2 7/2006 Roberts et al.
7,069,833 B2 7/2006 Roberts et al.
7,118,028 B2 10/2006 Liu et al.
D557,295 S * 12/2007 Formanek D15/127
7,467,578 B2 12/2008 Marocco
D595,345 S * 6/2009 Yagi et al. D18/53
D619,165 S * 7/2010 Sakurai D18/53
D619,166 S * 7/2010 Ishizawa et al. D18/53
7,752,724 B2 7/2010 Kollman et al.
2003/0066403 A1 4/2003 Lin et al.
2003/0106880 A1 * 6/2003 Lai 219/121.6

2003/0140756 A1 7/2003 Lin et al.
2004/0173076 A1 9/2004 Potts
2006/0065086 A1 3/2006 Swopes et al.
2006/0156882 A1 7/2006 Kollman et al.
2006/0179991 A1 8/2006 Nien et al.
2007/0000363 A1 1/2007 Kollman et al.
2009/0019978 A1 1/2009 Kollman
2009/0031876 A1 2/2009 Caputo et al.
2009/0064835 A1 3/2009 Nien
2009/0071307 A1 3/2009 Kollman
2009/0107313 A1 4/2009 Nien et al.
2010/0107833 A1 5/2010 Birch et al.
2010/0107839 A1 5/2010 Roberts et al.

OTHER PUBLICATIONS

U.S. Appl. No. 12/579,892, filed Oct. 15, 2009.
U.S. Appl. No. 12/939,946, filed Jul. 19, 2010.
U.S. Appl. No. 12/838,958, filed Jul. 19, 2010.
U.S. Appl. No. 12/838,993, filed Jul. 19, 2010.
U.S. Appl. No. 12/839,083, filed Jul. 19, 2010.
U.S. Appl. No. 12/839,027, filed Jul. 19, 2010.
U.S. Appl. No. 12/839,092, filed Jul. 19, 2010.
U.S. Appl. No. 12/838,975, filed Jul. 21, 2010.
U.S. Appl. No. 29/366,051, filed Jul. 19, 2010.
U.S. Appl. No. 29/366,052, filed Jul. 19, 2010.
U.S. Appl. No. 29/366,054, filed Jul. 19, 2010.
U.S. Appl. No. 29/366,058, filed Jul. 19, 2010.
U.S. Appl. No. 29/366,059, filed Jul. 19, 2010.
U.S. Appl. No. 29/366,061, filed Jul. 19, 2010.

* cited by examiner

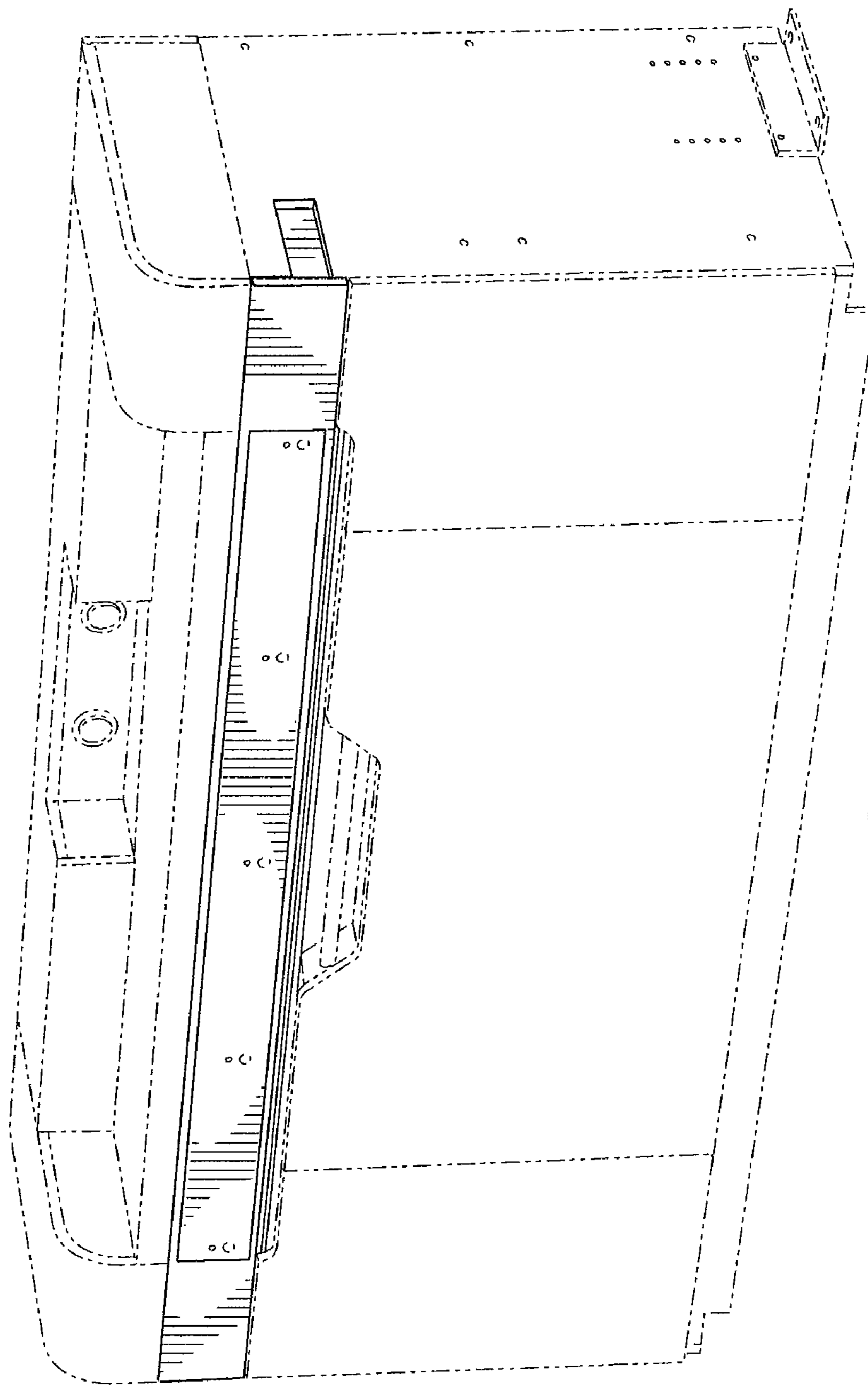

FIG. 1

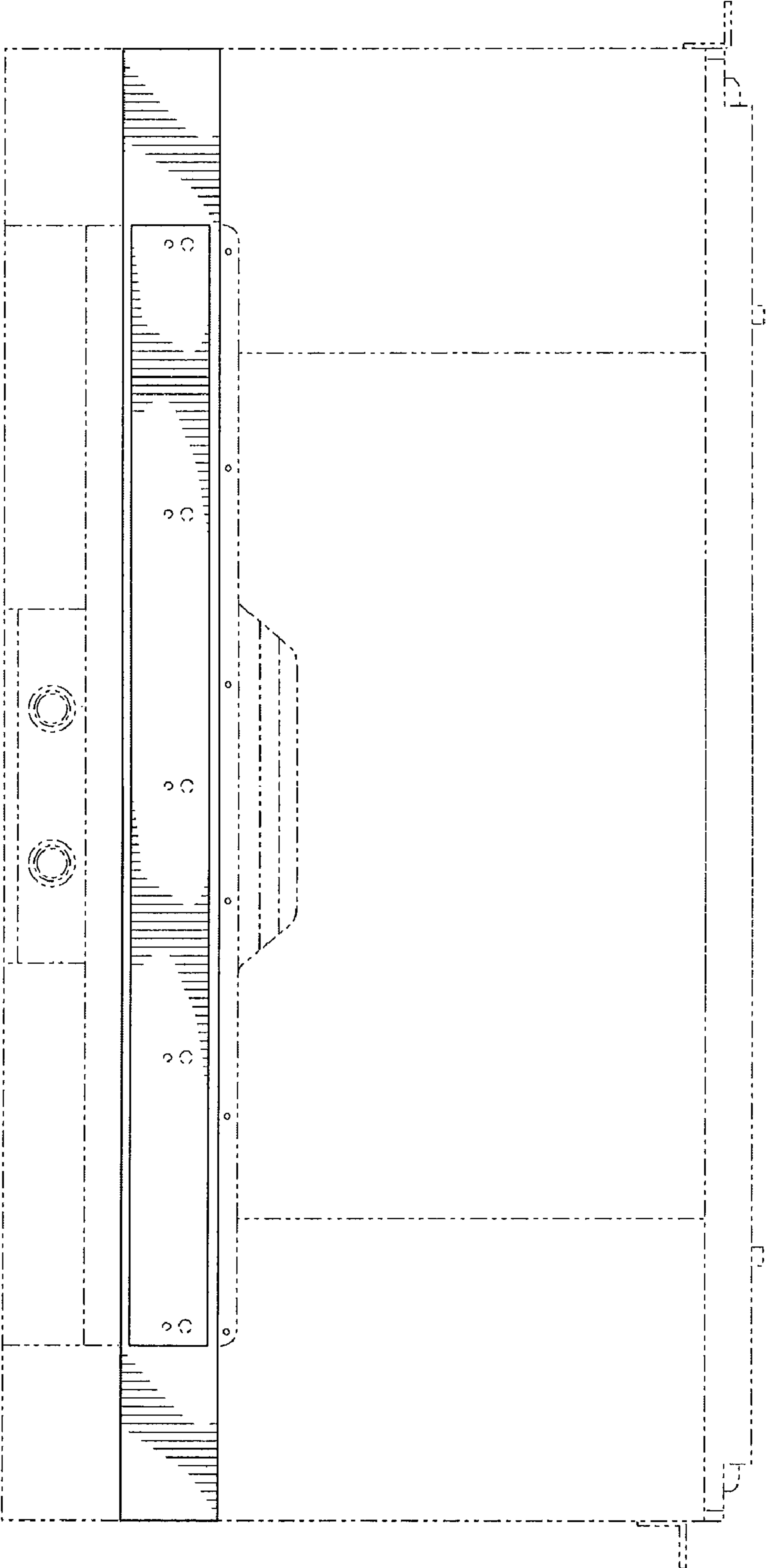

FIG. 2

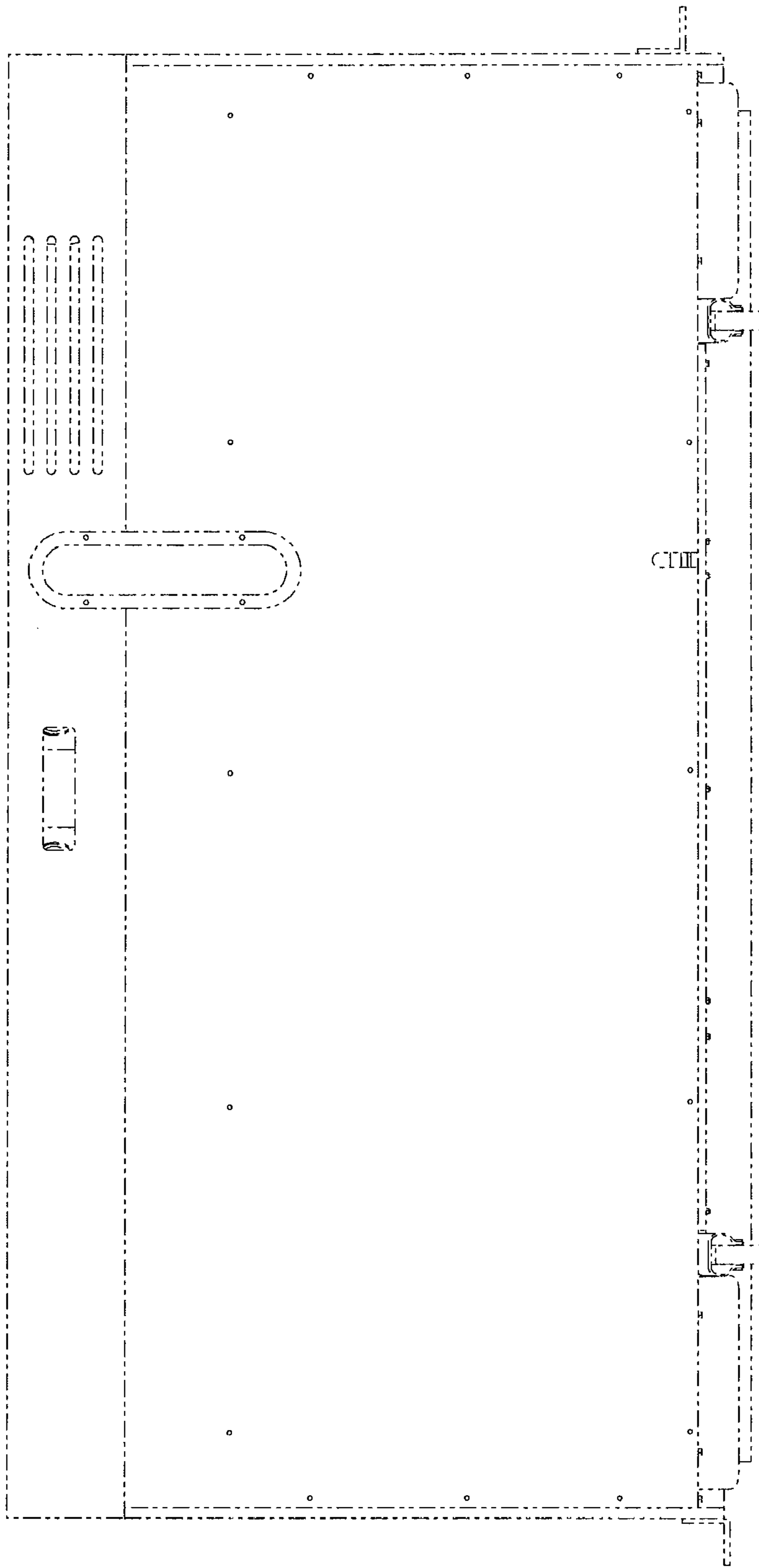

FIG. 3

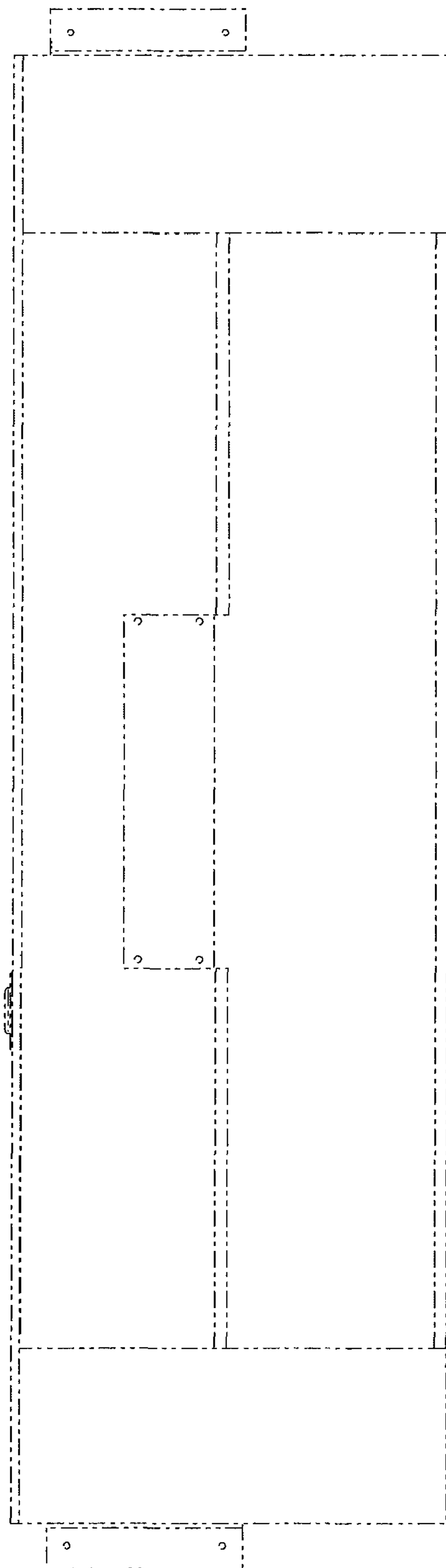

FIG. 4

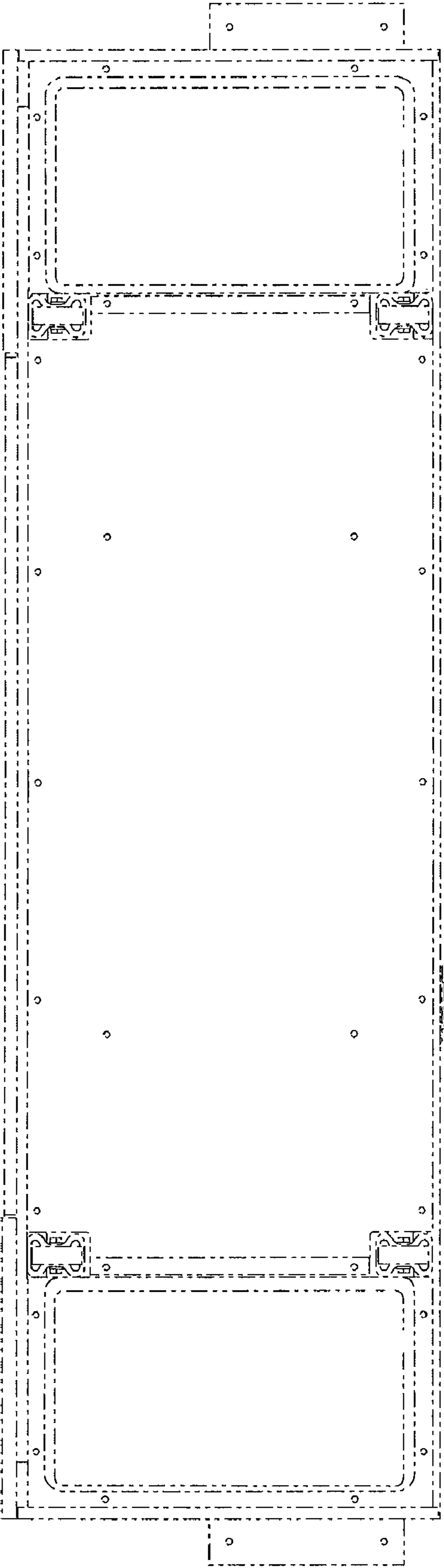

FIG. 5

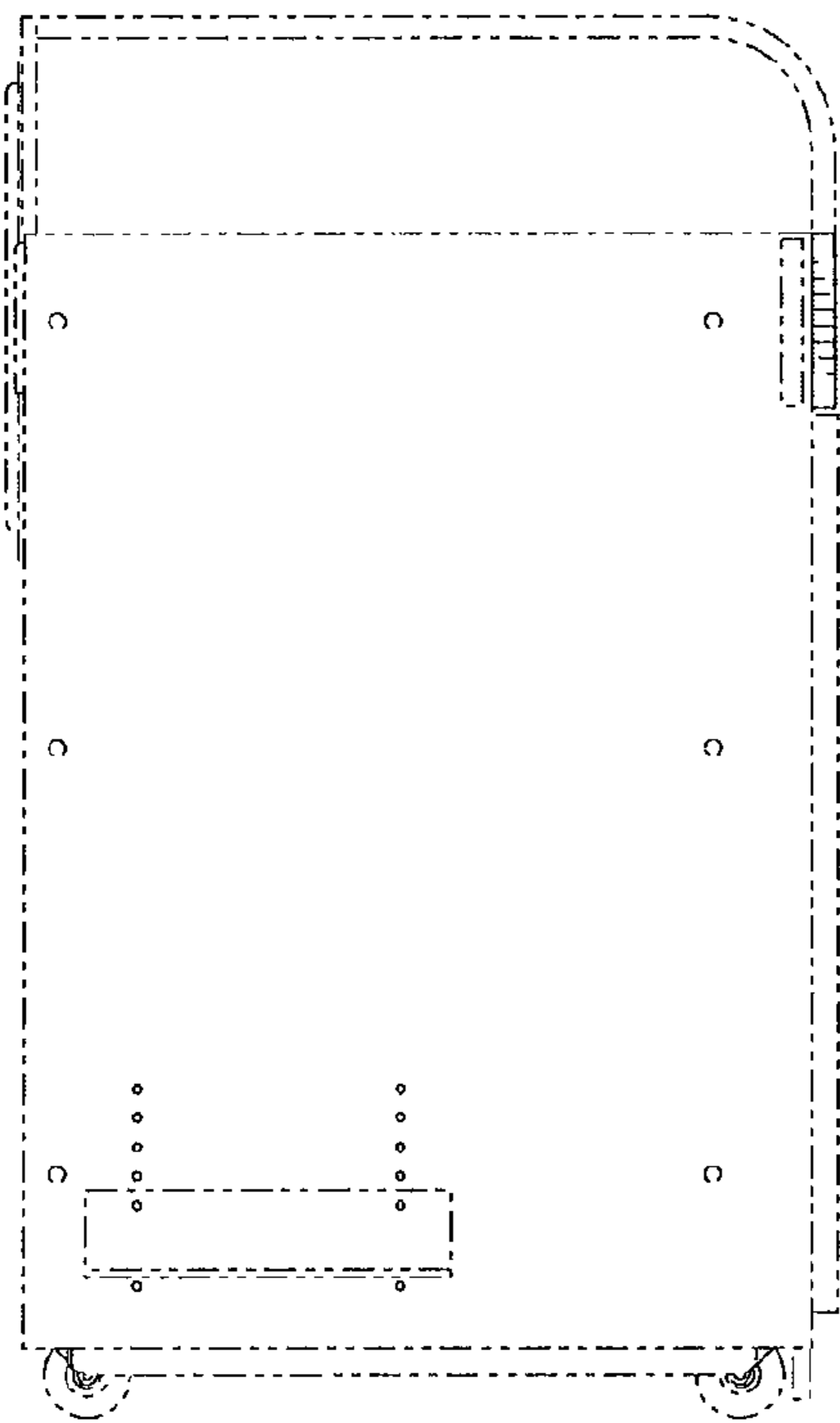

FIG. 6

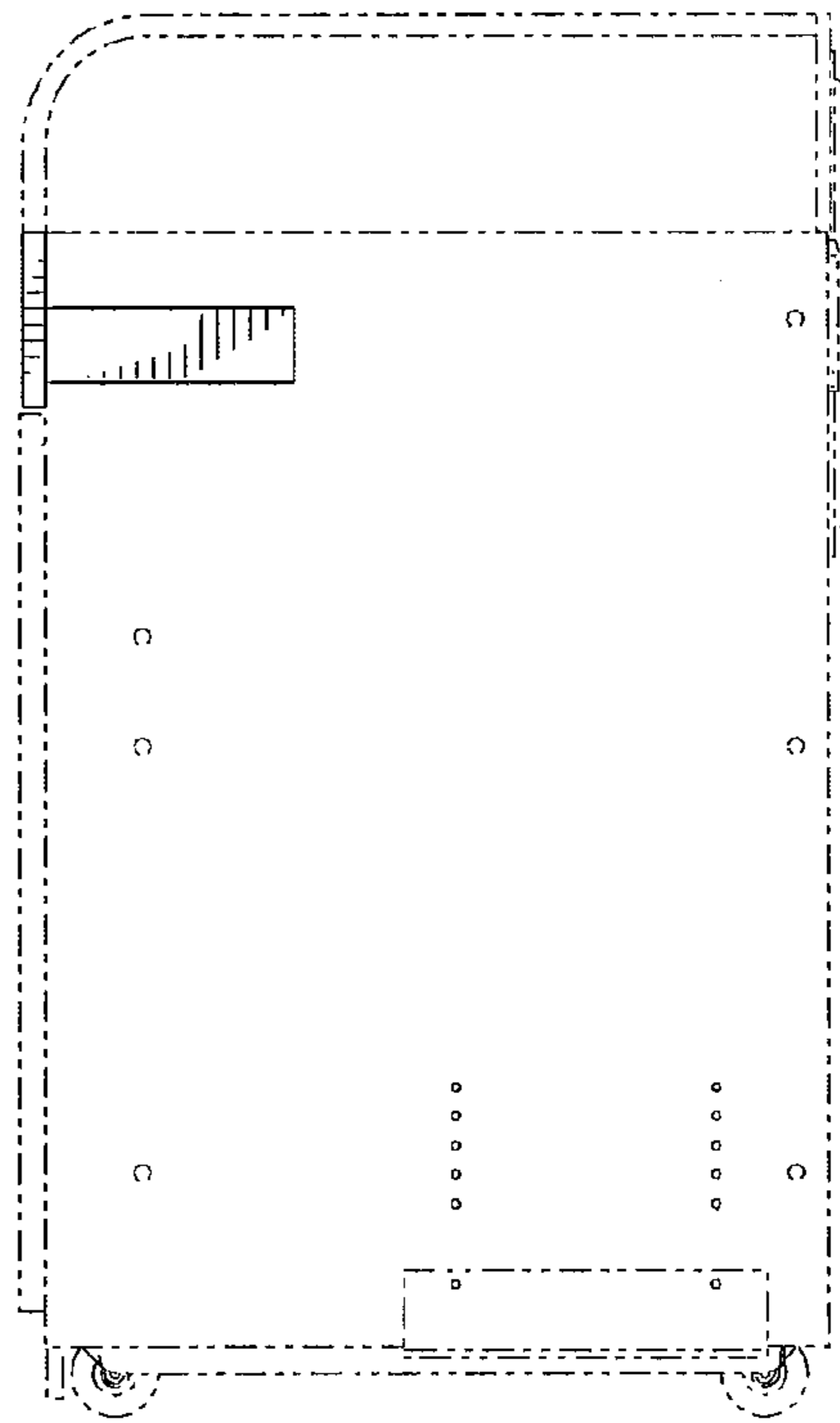

FIG. 7