

US00D632583S

(12) **United States Design Patent**  
**Eisenberger et al.**

(10) **Patent No.:** **US D632,583 S**  
(45) **Date of Patent:** **\*\* Feb. 15, 2011**

(54) **BOTTLE**

D549,589 S 8/2007 Lavigne  
D567,667 S 4/2008 Kikuchi  
D574,257 S 8/2008 Zeidan  
D595,591 S 7/2009 Andiano

(75) Inventors: **Harald Eisenberger**, New York, NY (US); **Sandra Monteparo**, Brooklyn, NY (US); **Dorothy Oge-Nichols**, Somerset, NJ (US); **Melanie Wiesenthal**, Brooklyn, NY (US)

(73) Assignee: **Victoria's Secret Stores Brand Management, Inc.**, Reynoldsburg, OH (US)

(\*\*) Term: **14 Years**

(21) Appl. No.: **29/349,243**

(22) Filed: **Mar. 19, 2010**

(51) **LOC (9) Cl.** ..... **09-01**  
(52) **U.S. Cl.** ..... **D9/661; D9/662**  
(58) **Field of Classification Search** ..... D9/600,  
D9/629, 655-664, 667, 723, 548; D11/157;  
206/457-458, 527; 220/890

See application file for complete search history.

(56) **References Cited**

**U.S. PATENT DOCUMENTS**

D74,600 S \* 3/1928 Gibson ..... D9/661  
D154,480 S 7/1949 High  
D158,365 S \* 5/1950 Fantel ..... D9/544  
D237,619 S \* 11/1975 Doherty ..... D9/661  
D427,074 S 6/2000 Harkness  
D474,107 S 5/2003 Osborne  
D481,957 S 11/2003 Modjeski  
D516,917 S 3/2006 Baron  
D529,813 S 10/2006 Modjeski  
D530,213 S 10/2006 Modjeski  
D530,216 S 10/2006 Modjeski  
D537,358 S 2/2007 Donegan et al.  
D542,147 S \* 5/2007 Donegan et al. .... D9/661

**OTHER PUBLICATIONS**

Marc Jacobs Daisy: Women's Fragrance <http://www.sephora.com/>, undated.

Suddz Soap Company—Decorative Soaps—Seashells Flowers Animals Americana <http://www.suddz.com/decorative.html>, Copyright 1999-2008.

Trademark Registration No. 2805992, Bottle Design, Filing date Oct. 23, 2002.

Trademark Registration No. 3443970, Bottle Design, Published Mar. 25, 2008.

Trademark Application No. 77696917, Prior Registration 2805992, Bottle Design, Filing date Mar. 18, 2009.

\* cited by examiner

*Primary Examiner*—Sandra Morris

(74) *Attorney, Agent, or Firm*—Ward & Olivo

(57) **CLAIM**

The ornamental design for a bottle, as shown and described.

**DESCRIPTION**

FIG. 1 is a perspective view of a bottle;

FIG. 2 is a front view thereof;

FIG. 3 is a rear view thereof;

FIG. 4 is a right side view thereof;

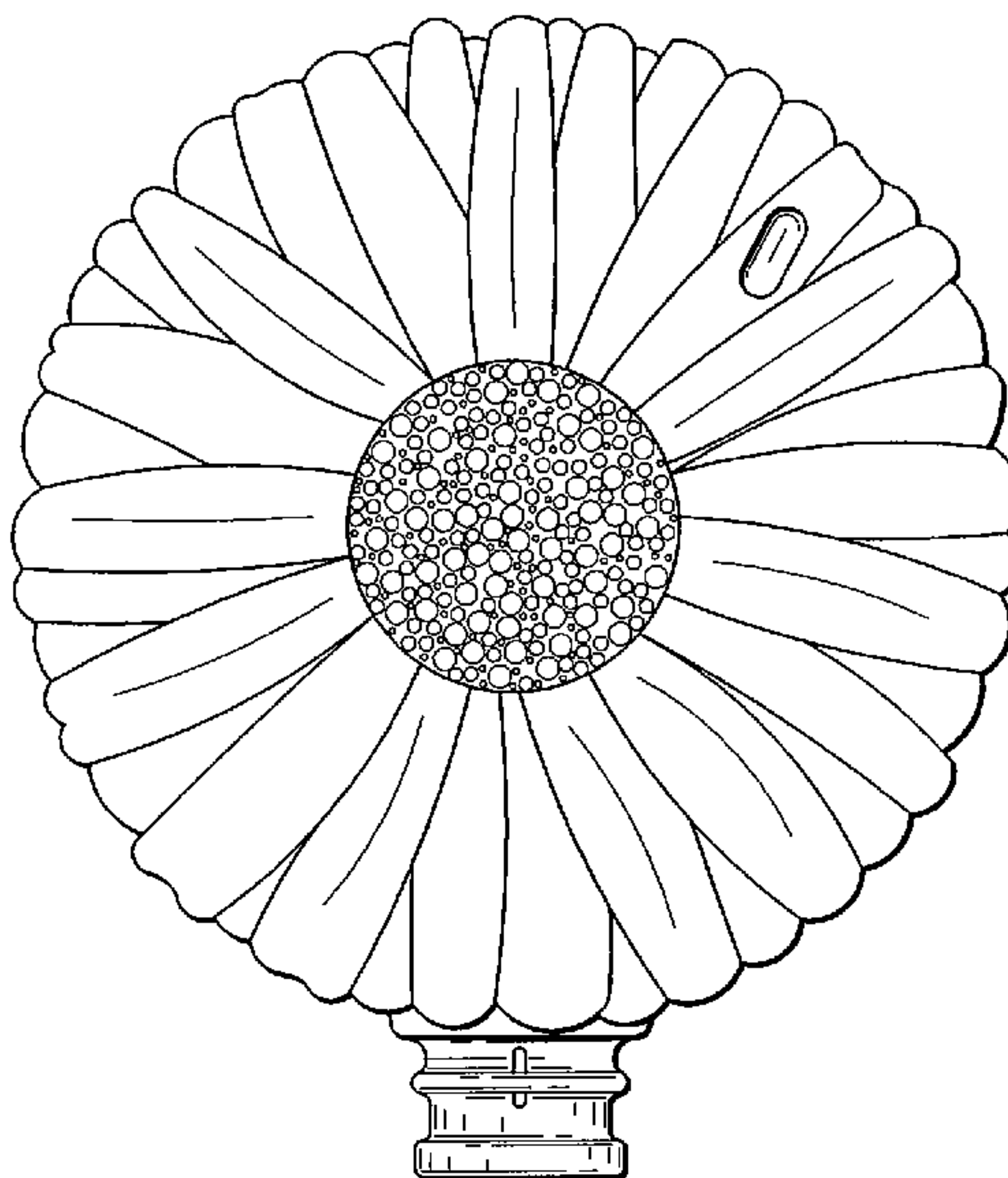
FIG. 5 is a left side view thereof;

FIG. 6 is a top view thereof; and,

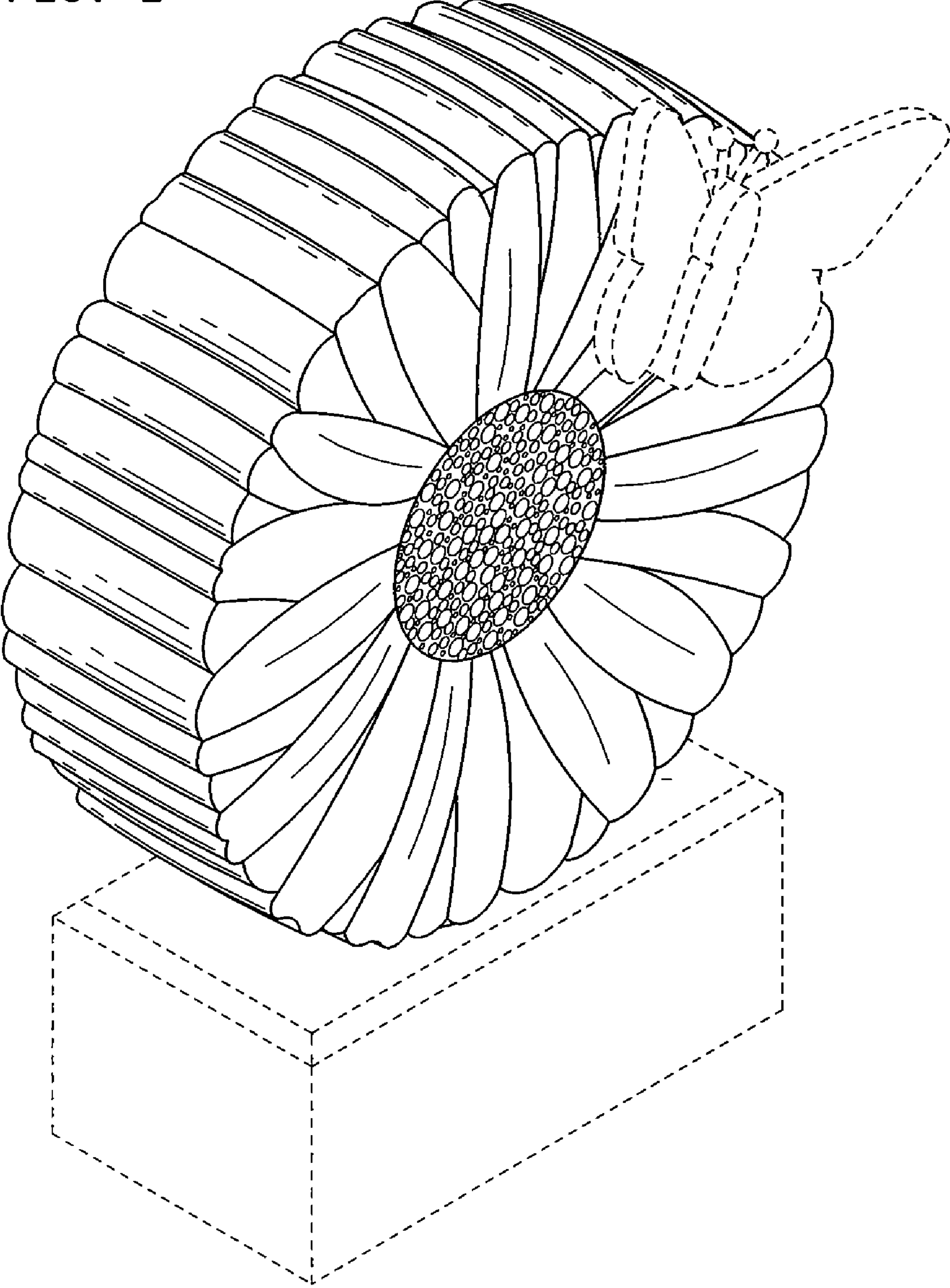
FIG. 7 is a bottom view thereof.

The broken lines shown in the figures are for illustrative purposes only and form no part of the claimed design.

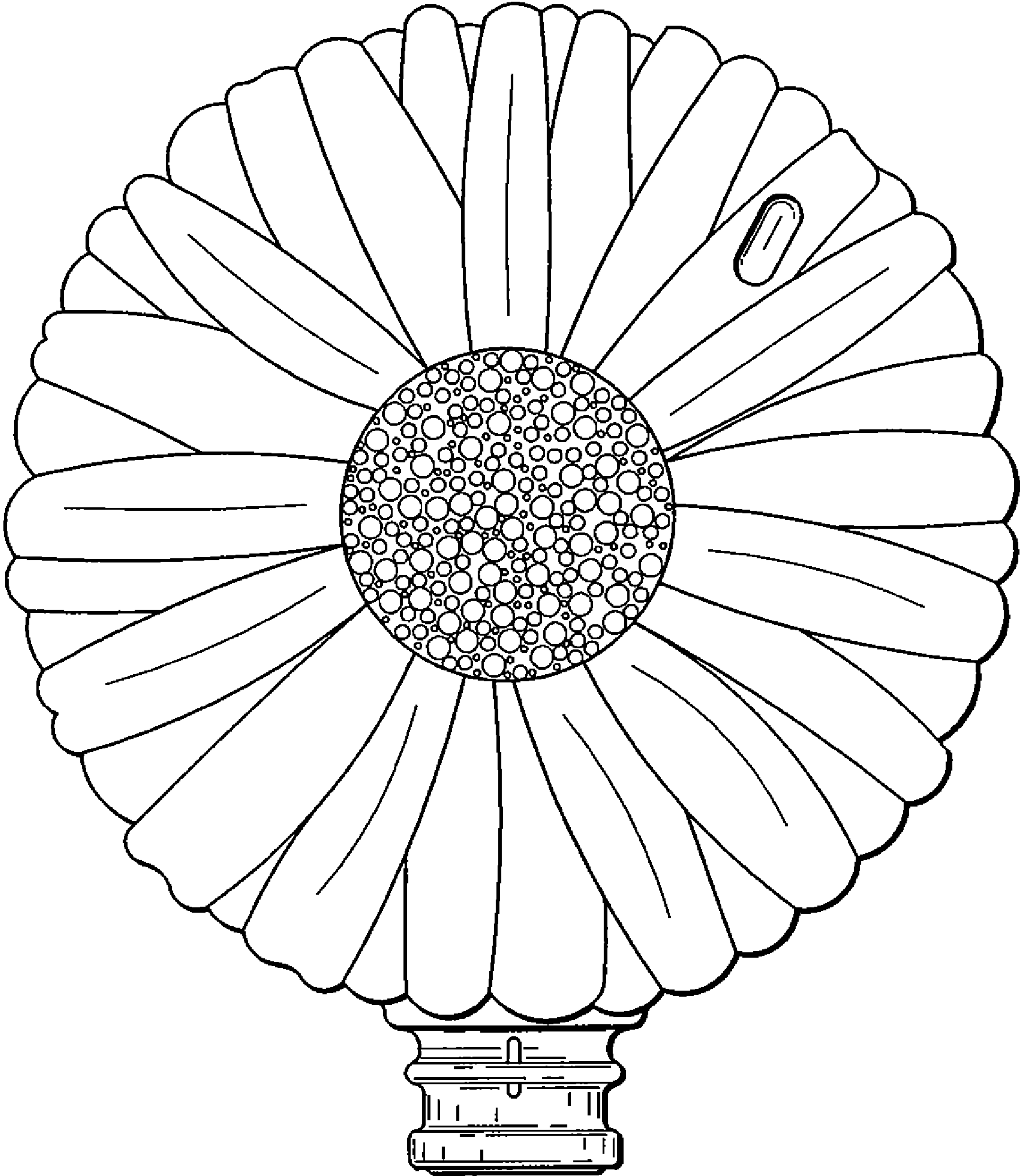
**1 Claim, 5 Drawing Sheets**



**FIG. 1**

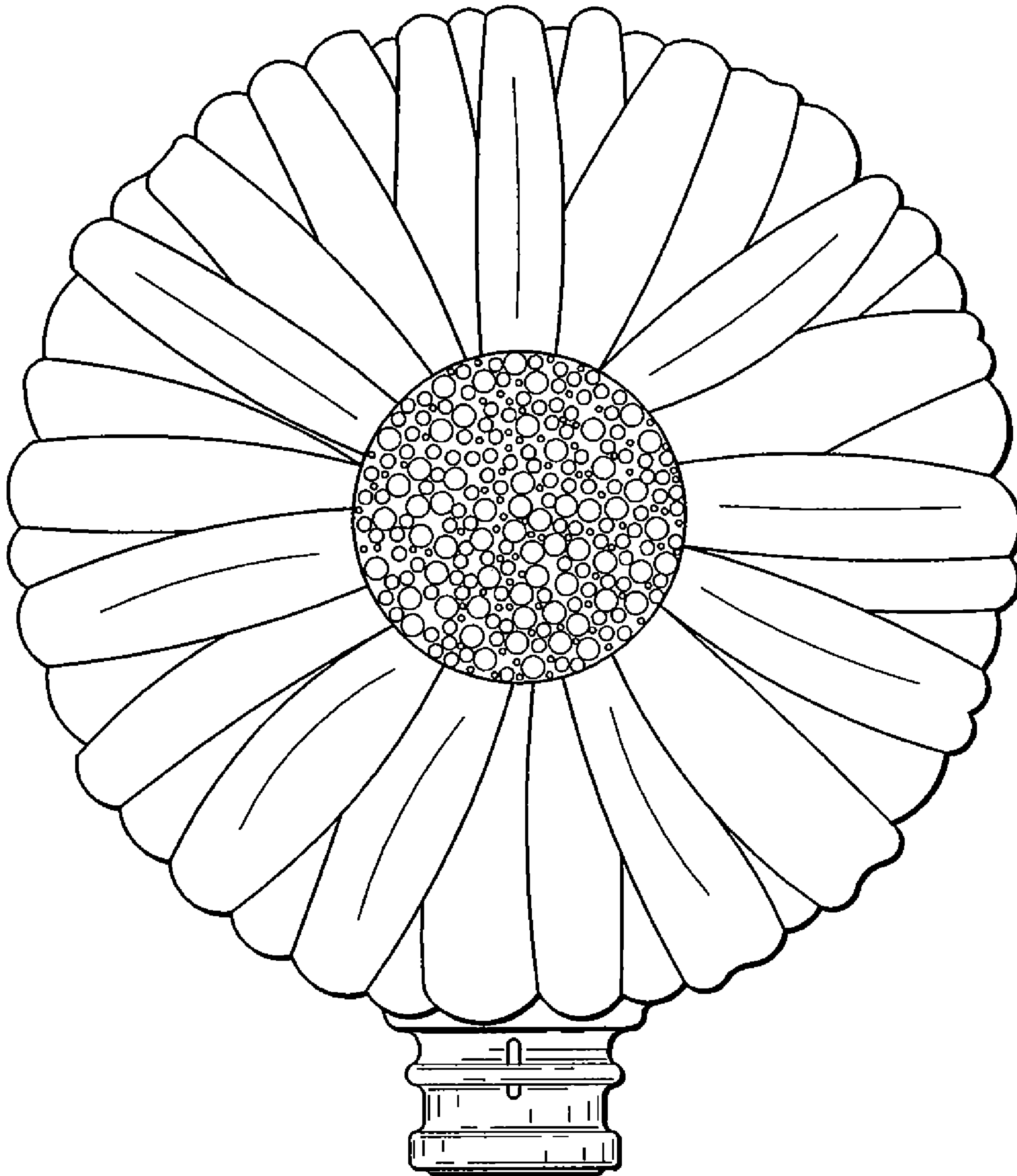


**FIG. 2**

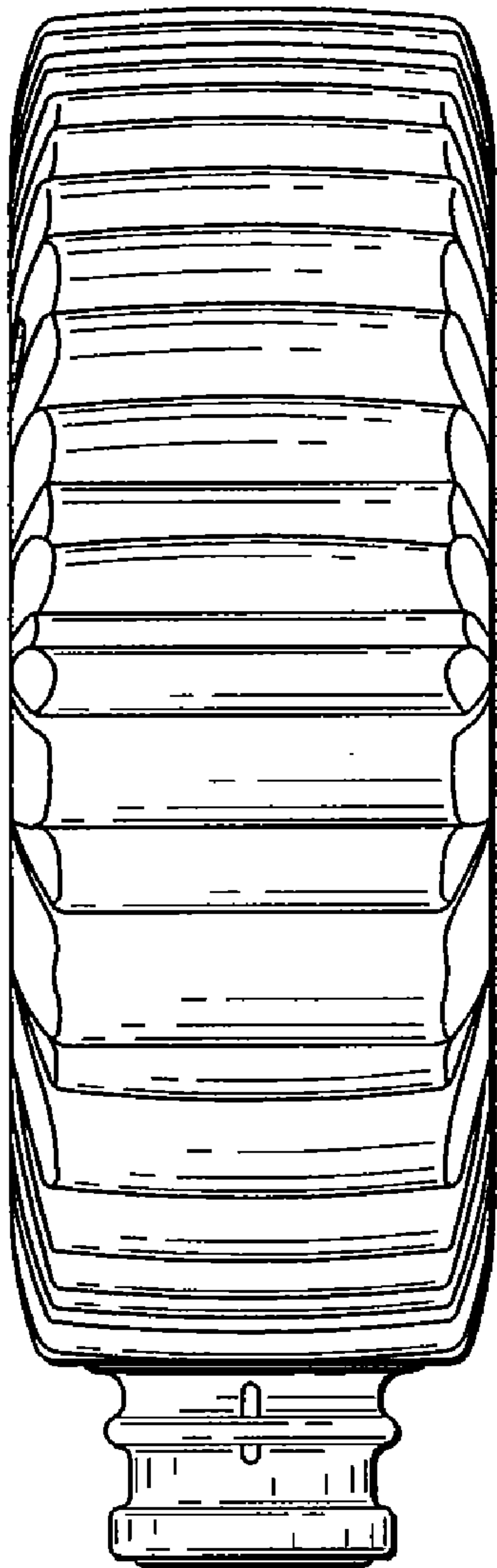




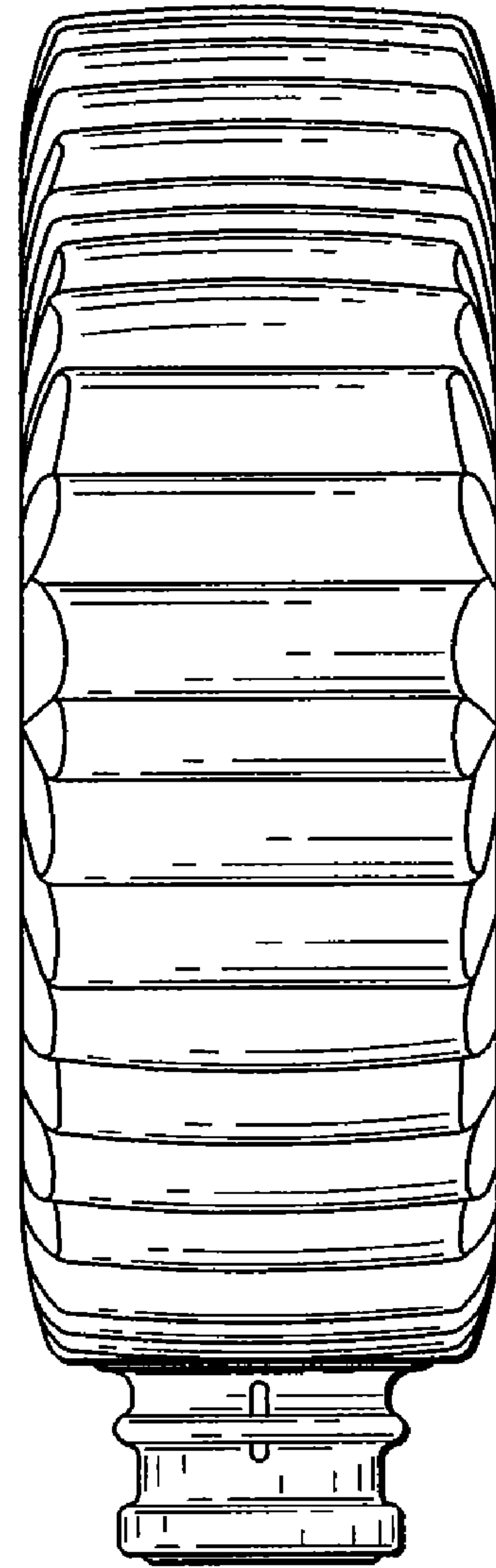
**FIG. 3**



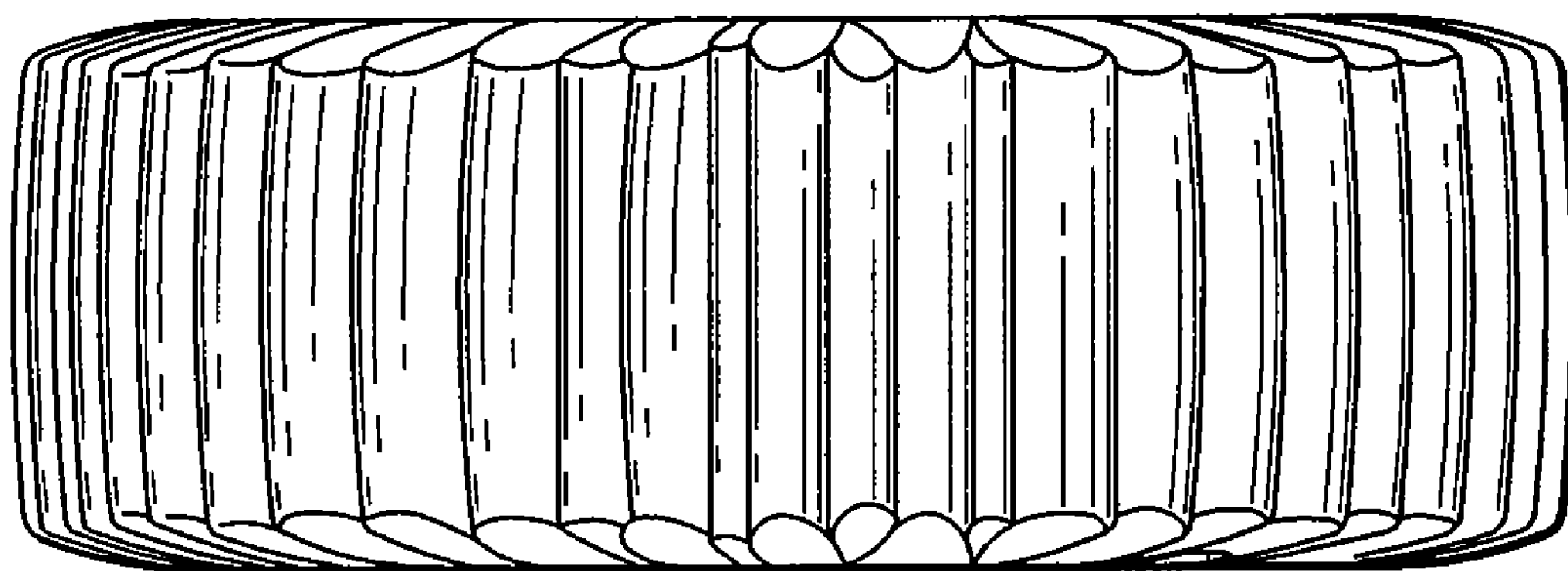
**FIG. 4**



**FIG. 5**



**FIG. 6**



**FIG. 7**

