



US00D632550S

(12) **United States Design Patent**
Watanabe

(10) **Patent No.:** **US D632,550 S**
(45) **Date of Patent:** **** Feb. 15, 2011**

(54) **GROMMET**

DESCRIPTION

(75) Inventor: **Yasuhiro Watanabe**, Yokohama (JP)

(73) Assignee: **Nifco Inc.**, Yokohama-Shi,
Kanagawa-Ken (JP)

(**) Term: **14 Years**

(21) Appl. No.: **29/347,982**

(22) Filed: **Aug. 30, 2010**

(30) **Foreign Application Priority Data**

Mar. 3, 2010 (JP) 2010-005021

(51) **LOC (9) Cl.** **08-08**

(52) **U.S. Cl.** **D8/382**

(58) **Field of Classification Search** D8/382,
D8/349, 354; D11/86; 411/508-510; 403/300,
403/345

See application file for complete search history.

(56) **References Cited**

U.S. PATENT DOCUMENTS

D293,882 S * 1/1988 Takahashi D8/386
D374,610 S * 10/1996 Shimazu D8/382
D390,776 S * 2/1998 Ueno D8/382
D456,699 S * 5/2002 Nakanishi D8/382

(Continued)

Primary Examiner—Holly H Baynham

Assistant Examiner—Sheryl Lane

(74) *Attorney, Agent, or Firm*—Manabu Kanesaka

(57) **CLAIM**

The ornamental design for a grommet, as shown and described.

FIG. 1 is a front view of a grommet showing my new design, a rear view being the same as the front view;

FIG. 2 is a plan view thereof;

FIG. 3 is a right side view thereof, a left side view being the same as the right side view;

FIG. 4 is a bottom side view thereof;

FIG. 5 is a sectional view thereof taken along line 5—5 in FIG. 2;

FIG. 6 is a sectional view thereof taken along line 6—6 in FIG. 2;

FIG. 7 is a front view of an axis portion of the grommet, a rear view being the same as the front view;

FIG. 8 is a plan view of the axis portion of the grommet;

FIG. 9 is a right side view of the axis portion of the grommet, a left side view being the same as the right side view;

FIG. 10 is a bottom view of the axis portion of the grommet;

FIG. 11 is a sectional view of the axis portion of the grommet taken along line 11—11 in FIG. 8;

FIG. 12 is a sectional view of the axis portion of the grommet taken along line 12—12 in FIG. 8;

FIG. 13 is a front view of a main body of the grommet, a rear view being the same as the front view;

FIG. 14 is a plan view of the main body of the grommet;

FIG. 15 is a right side view of the main body of the grommet, a left side view being the same as the right side view;

FIG. 16 is a bottom view of the main body of the grommet; and,

FIG. 17 is a sectional view of the main body of the grommet taken along line 17—17 in FIG. 14.

FIGS. 7-17 are shown separated for ease of illustration.

1 Claim, 6 Drawing Sheets

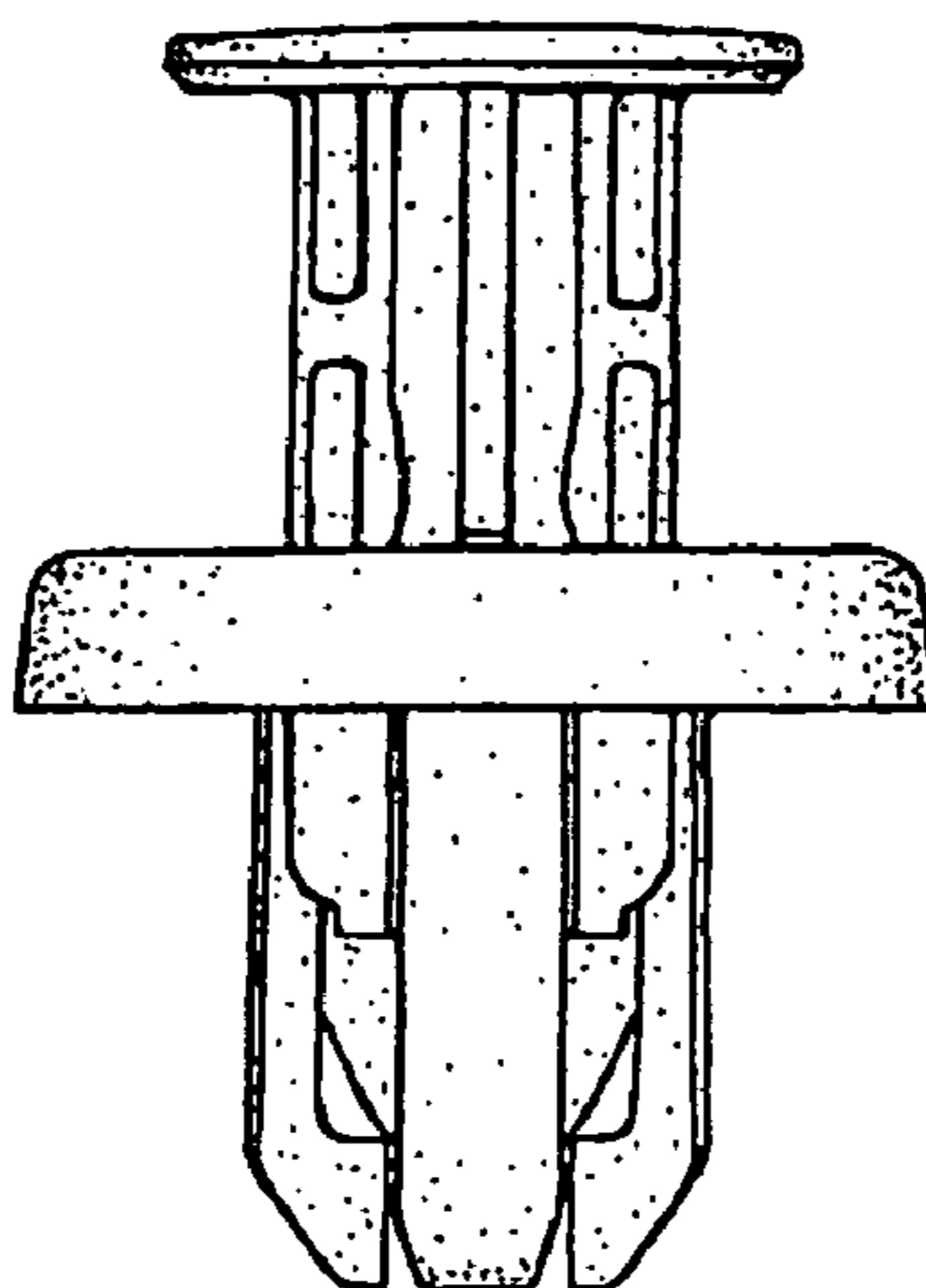

US D632,550 S

Page 2

U.S. PATENT DOCUMENTS

D498,414 S *	11/2004	Yoneoka	D8/382	D589,333 S *	3/2009	Nakazato	D8/382
6,910,840 B2 *	6/2005	Anscher	411/41	D590,241 S *	4/2009	Kubo et al.	D8/382
D564,344 S *	3/2008	Nakazato	D8/382	D617,178 S *	6/2010	Sakai	D8/382
D566,534 S *	4/2008	Okada	D8/382	D625,587 S *	10/2010	Obuchi et al.	D8/382
D566,535 S *	4/2008	Asano et al.	D8/382	2005/0244250 A1 *	11/2005	Okada et al.	411/508

* cited by examiner

Fig. 1

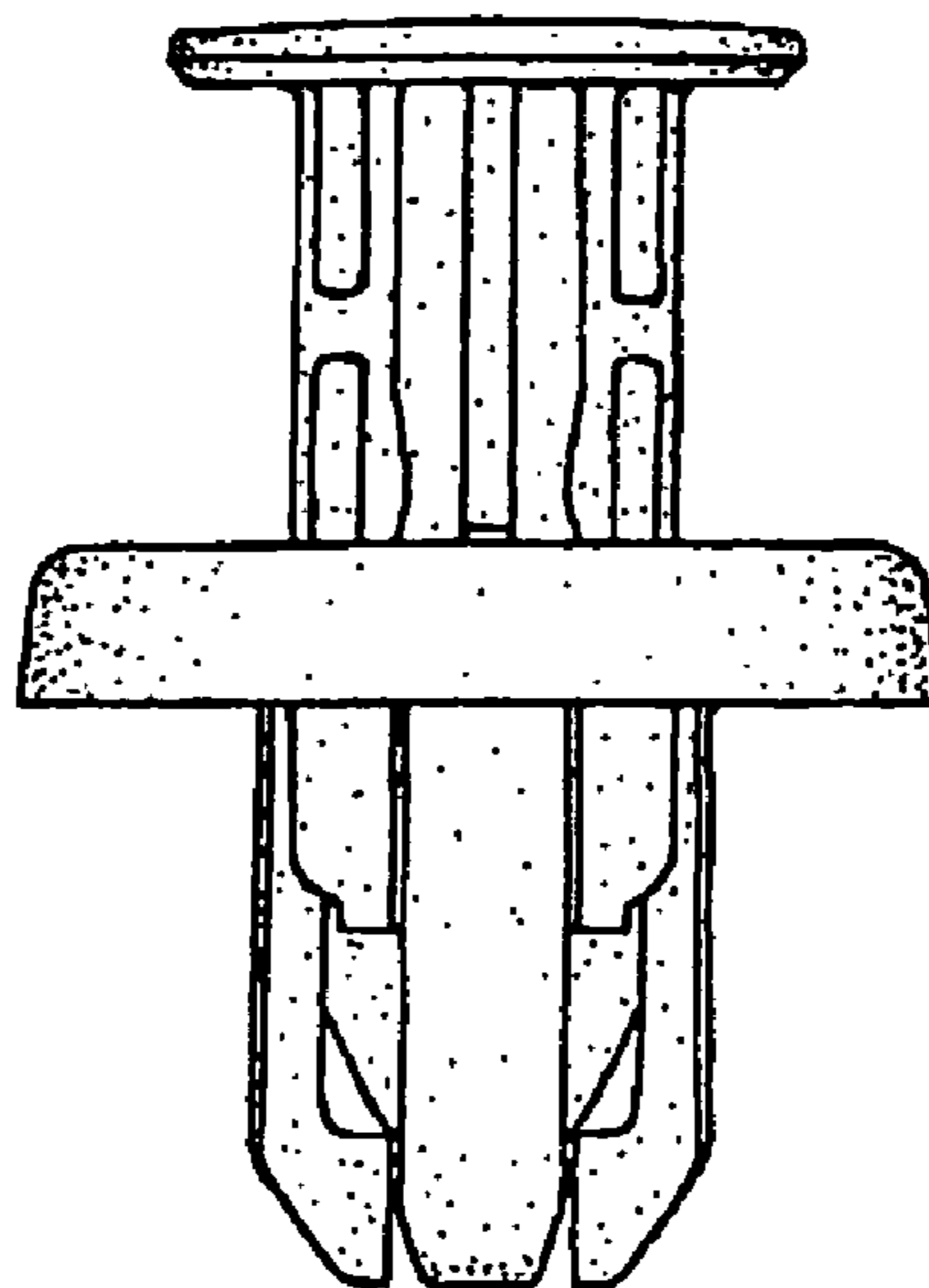

Fig. 2

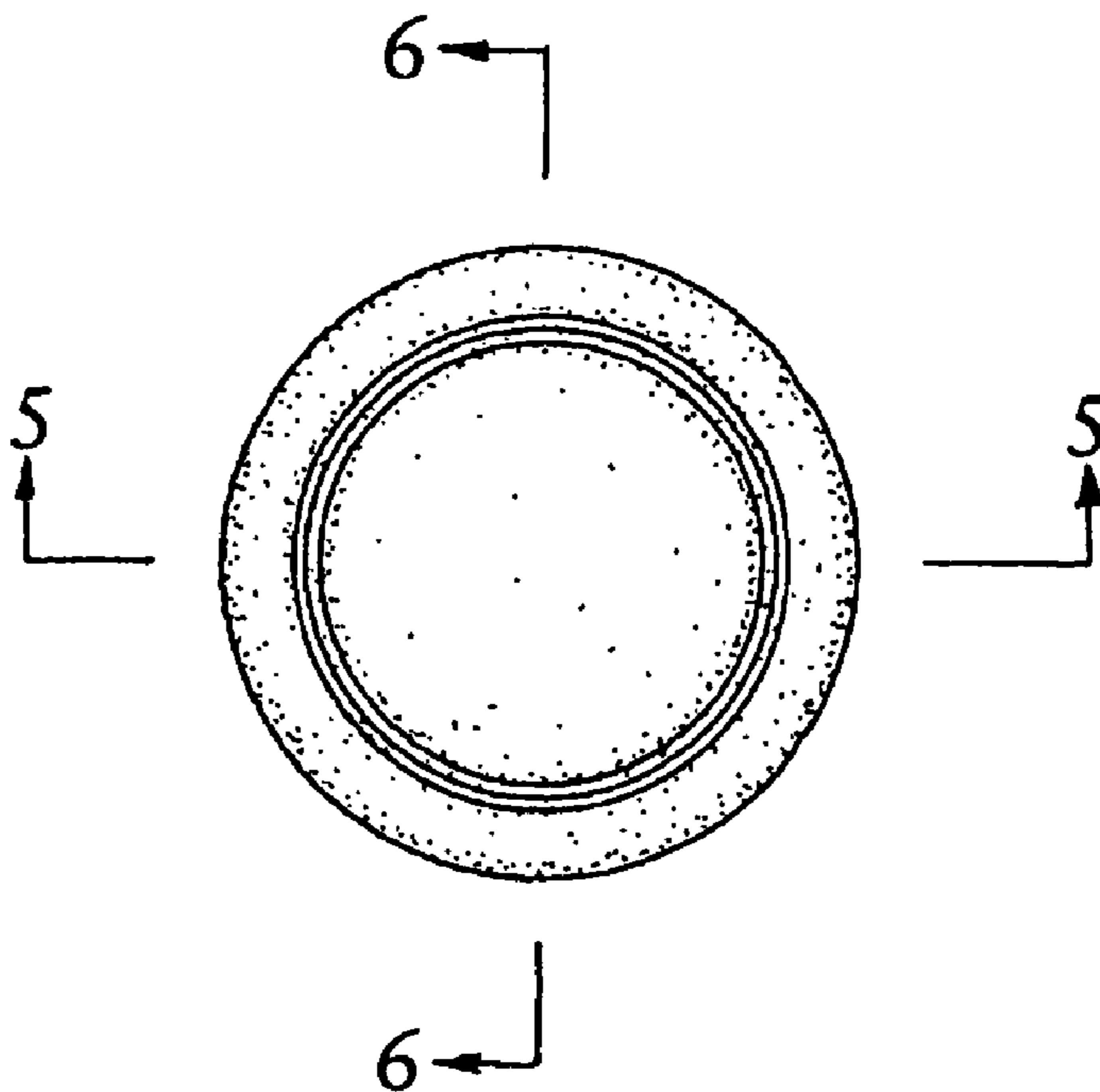

Fig. 3

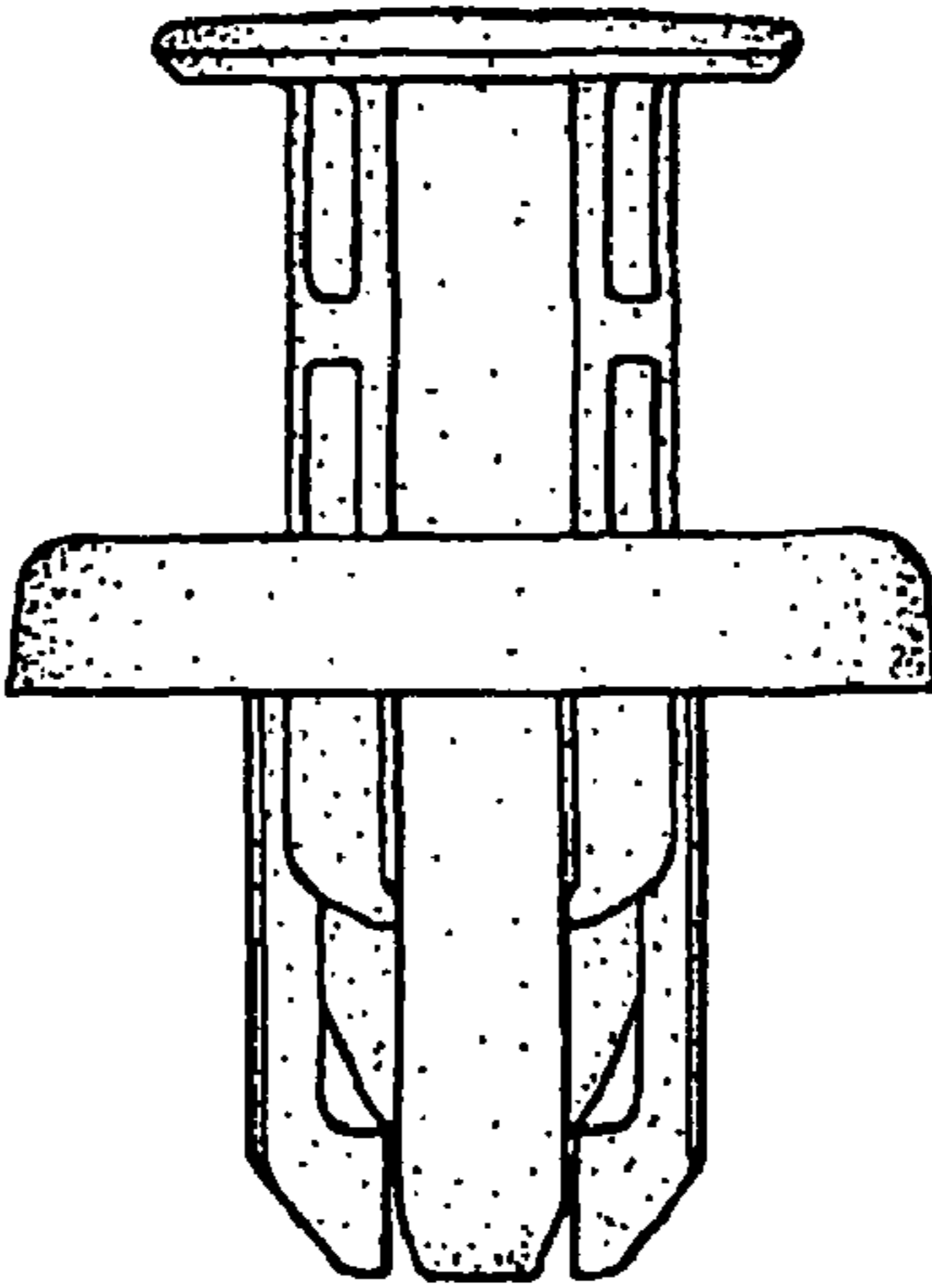

Fig. 4

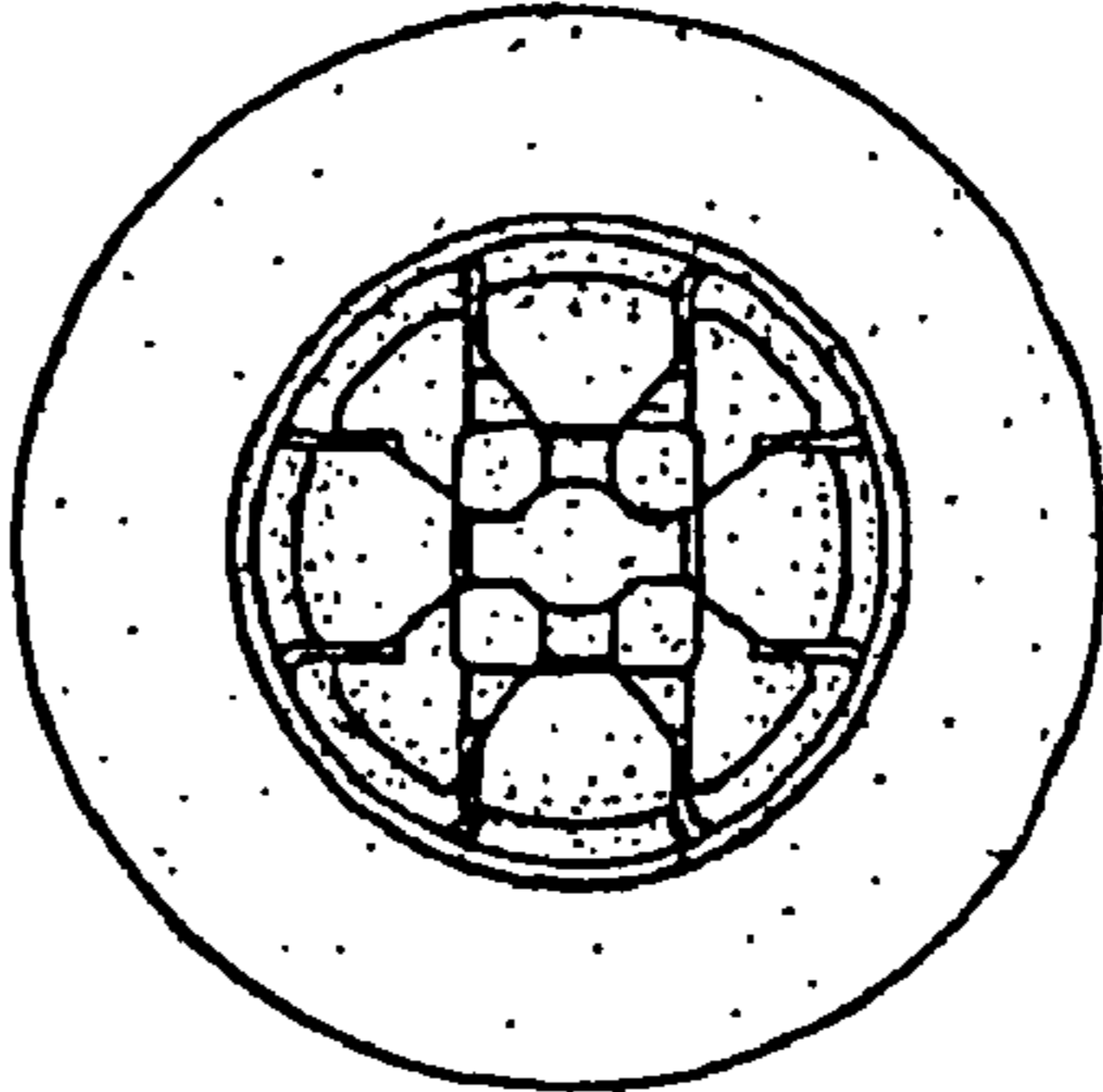

Fig. 5

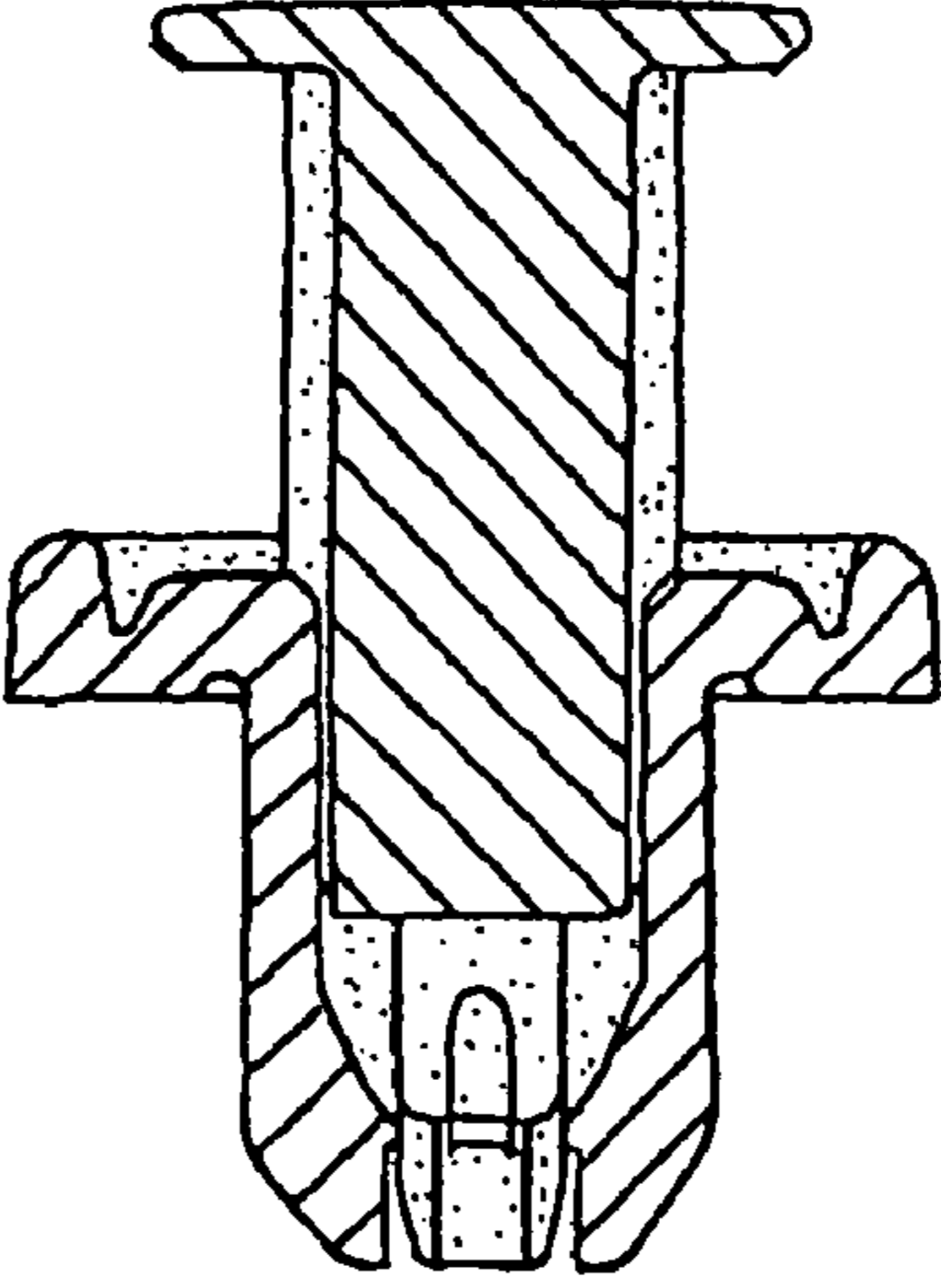

Fig. 6

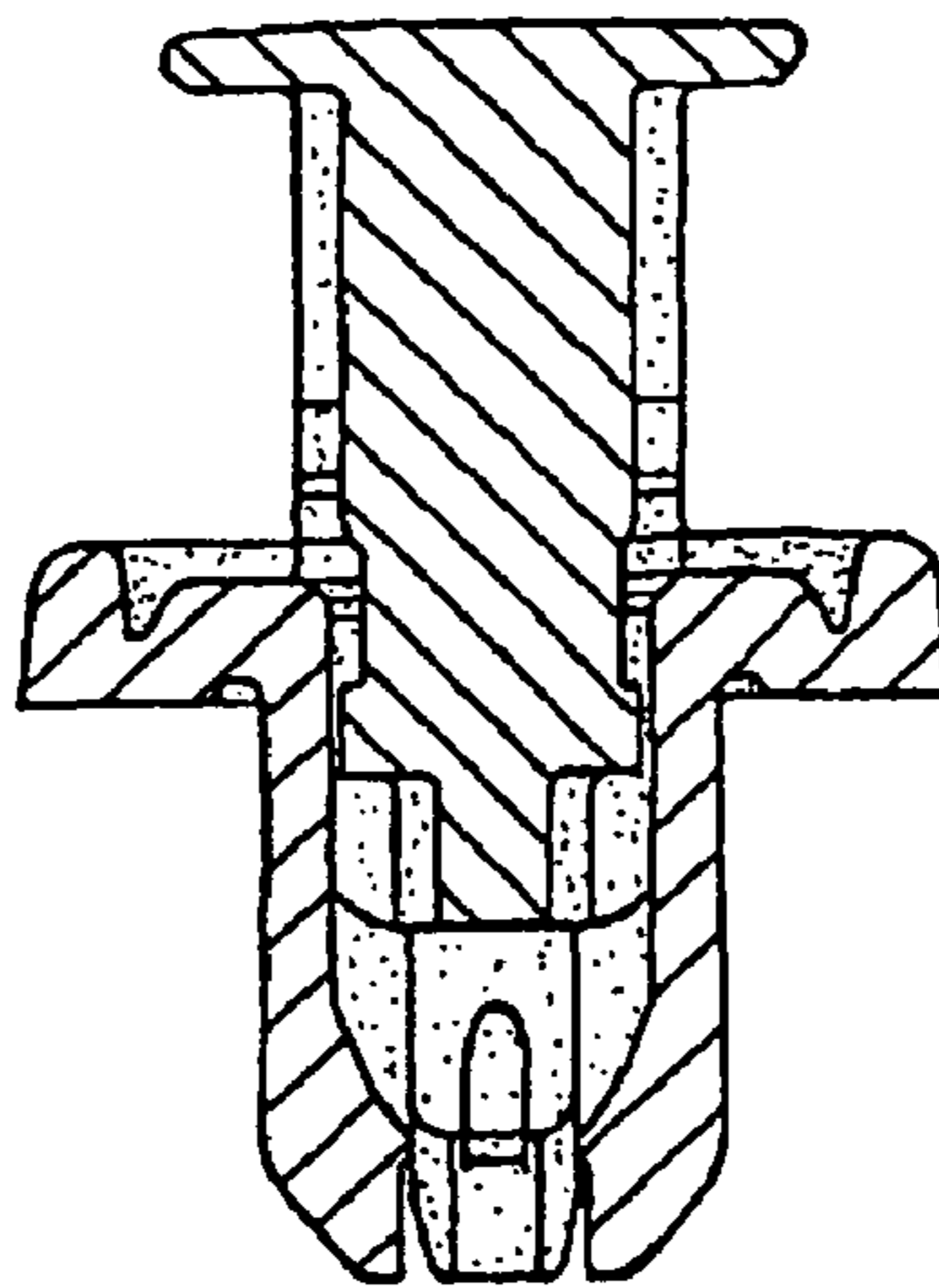

Fig. 7

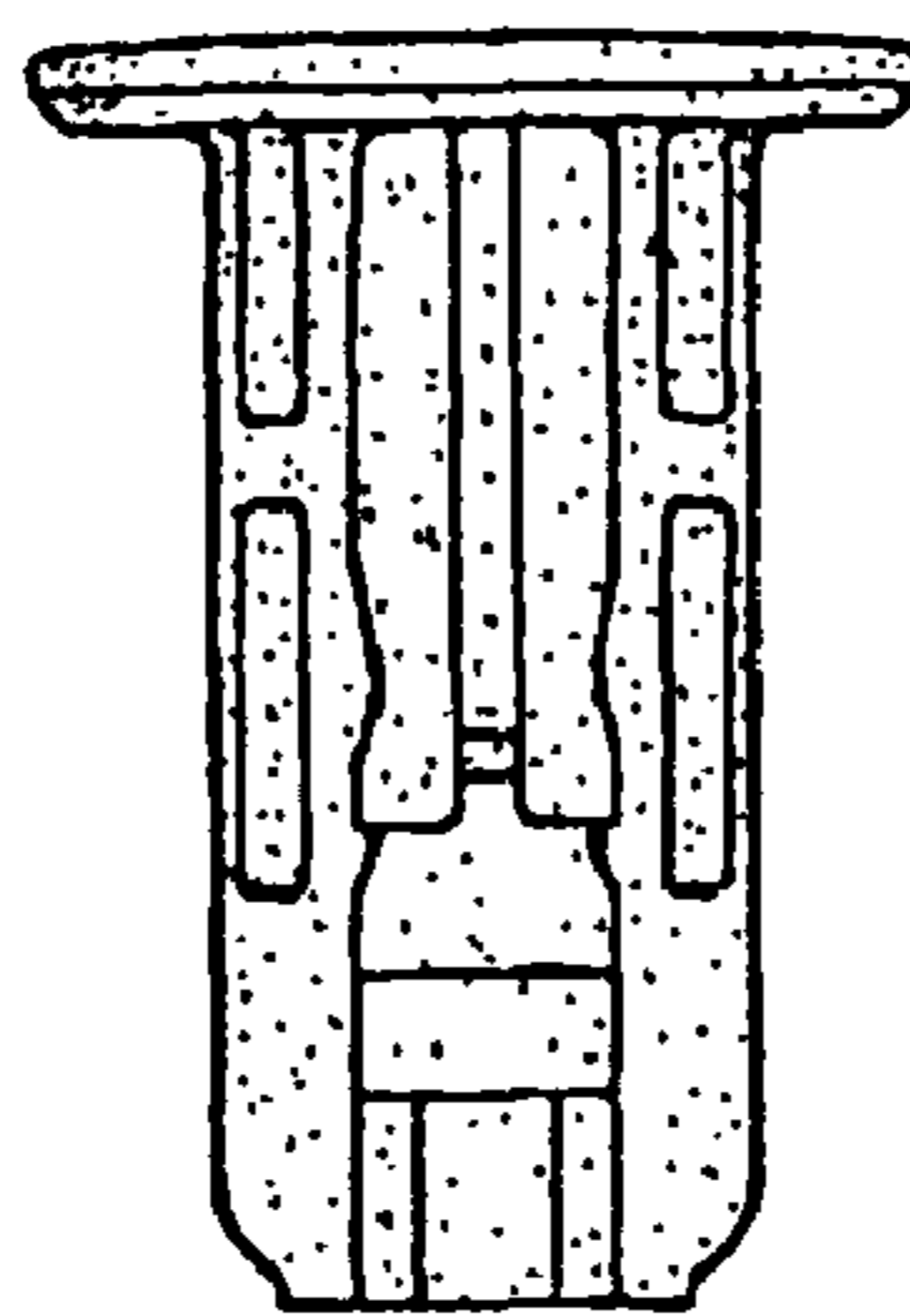

Fig. 8

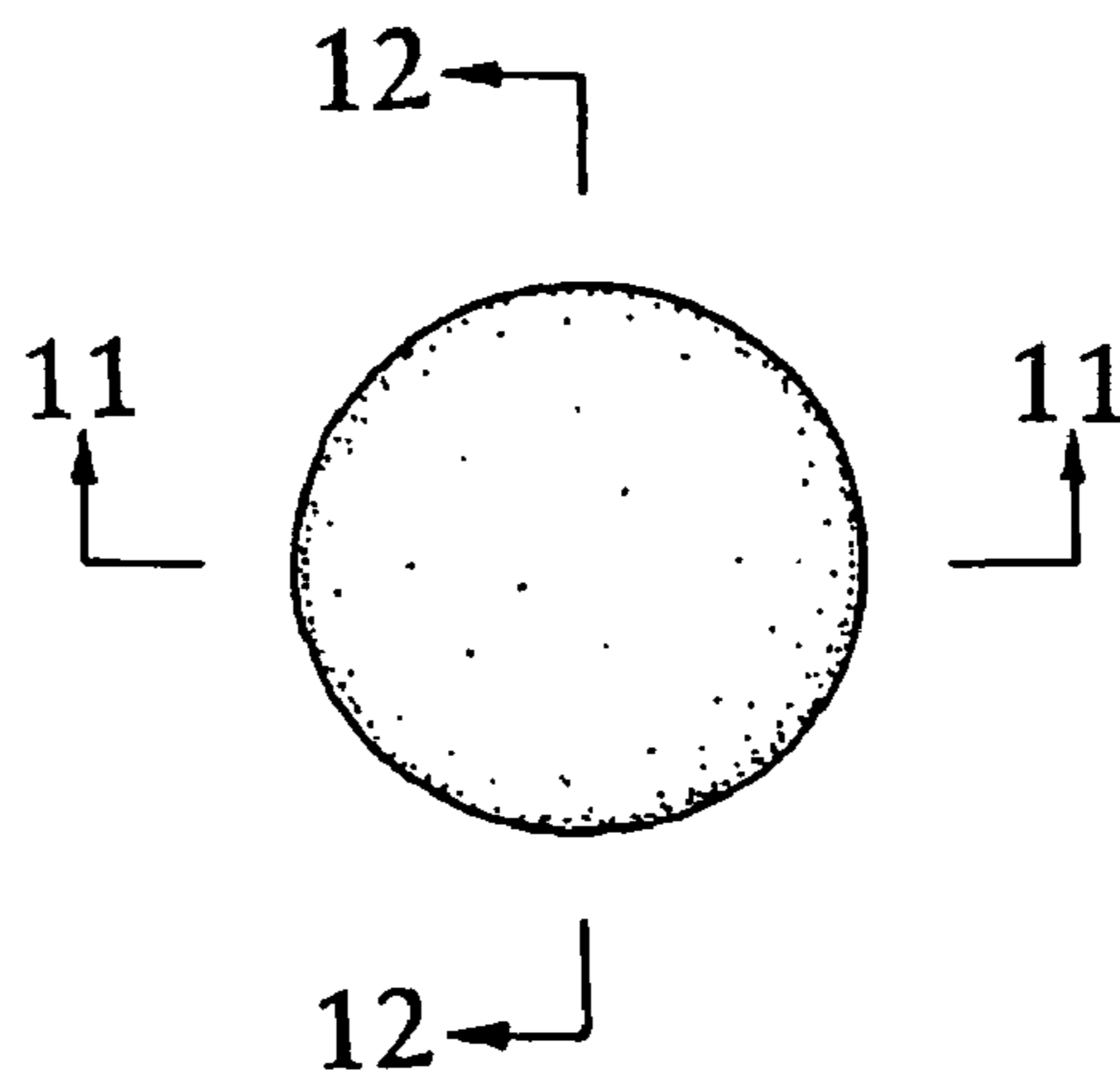

Fig. 9

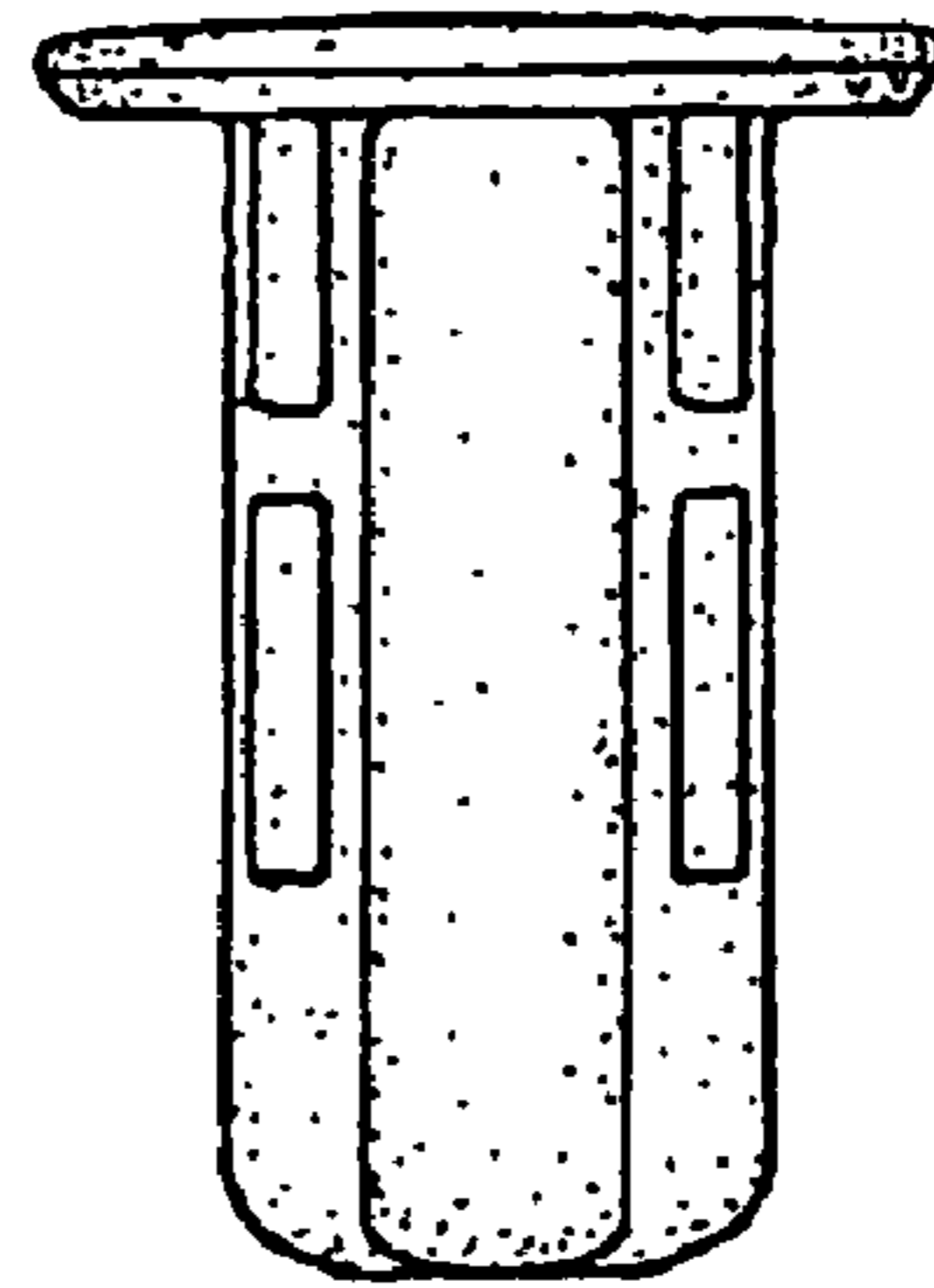

Fig. 10

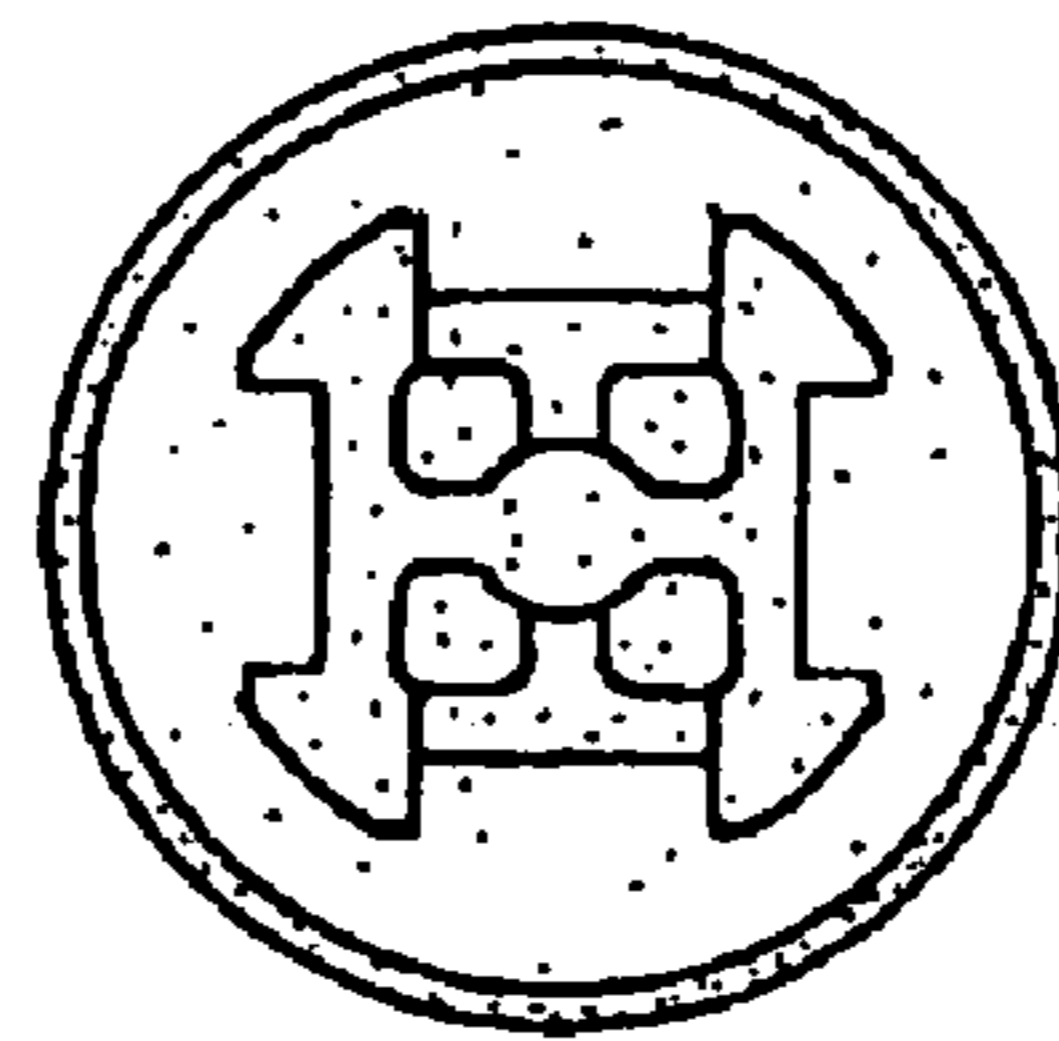

Fig. 11

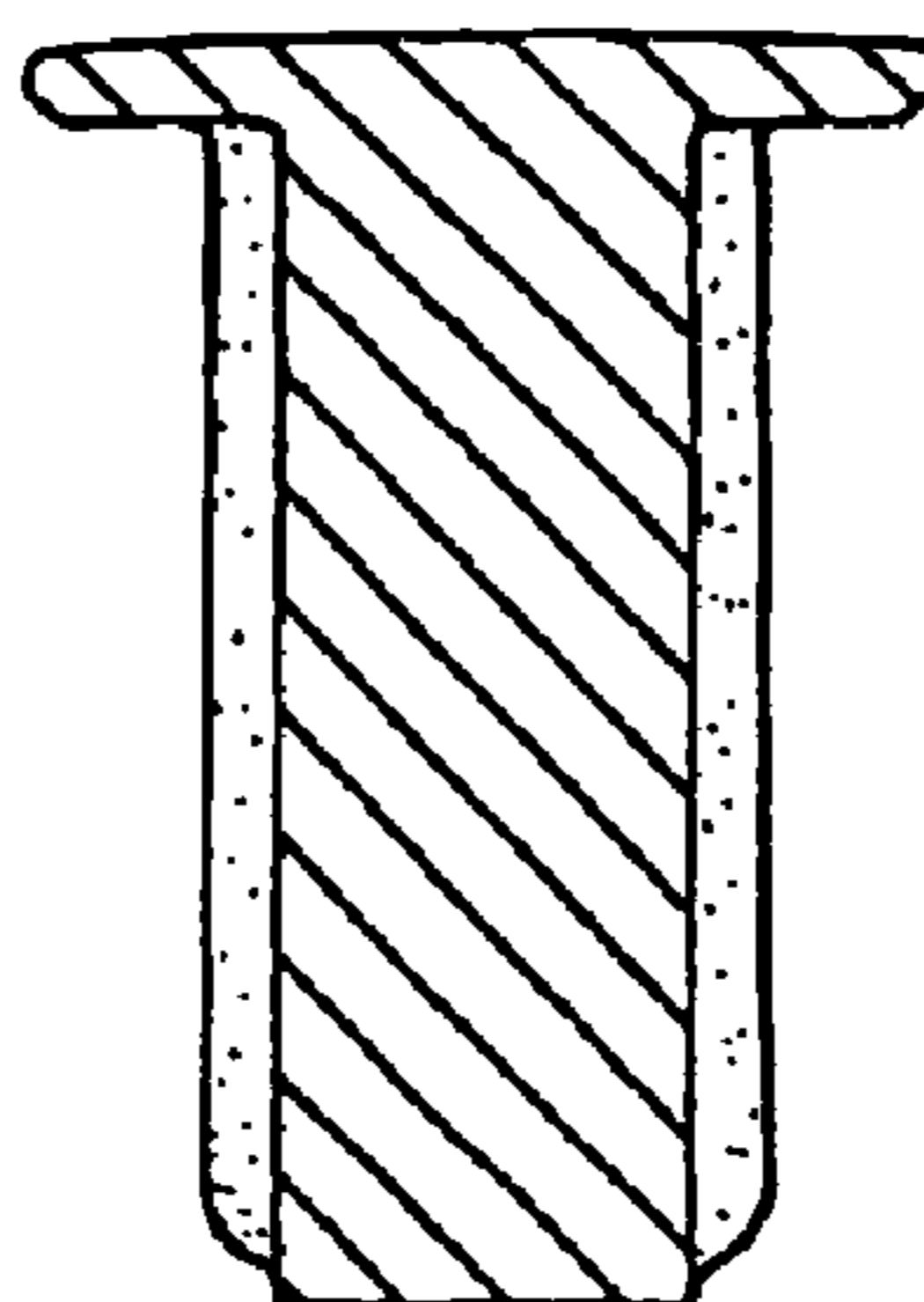

Fig. 12

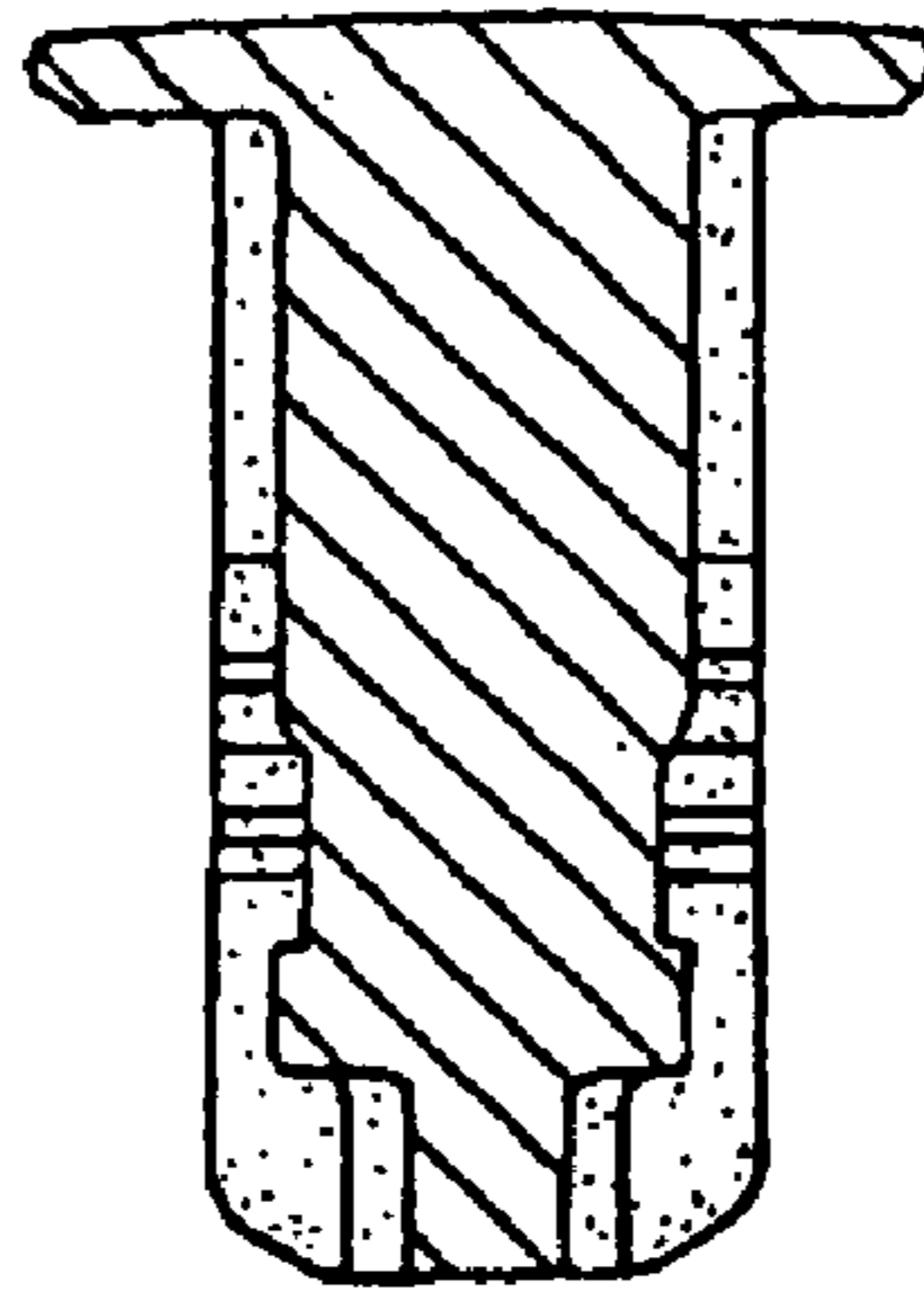

Fig. 13

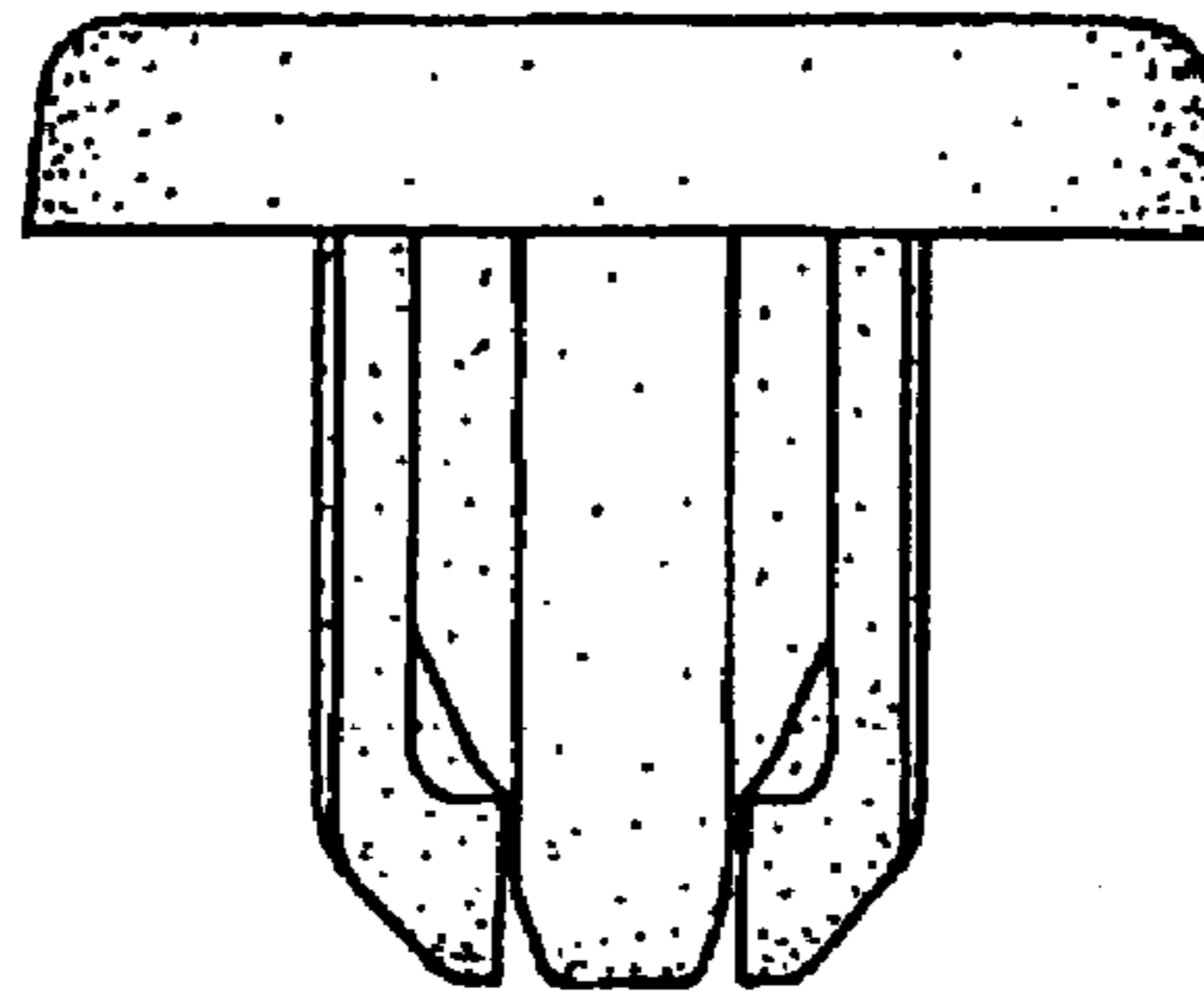

Fig. 14

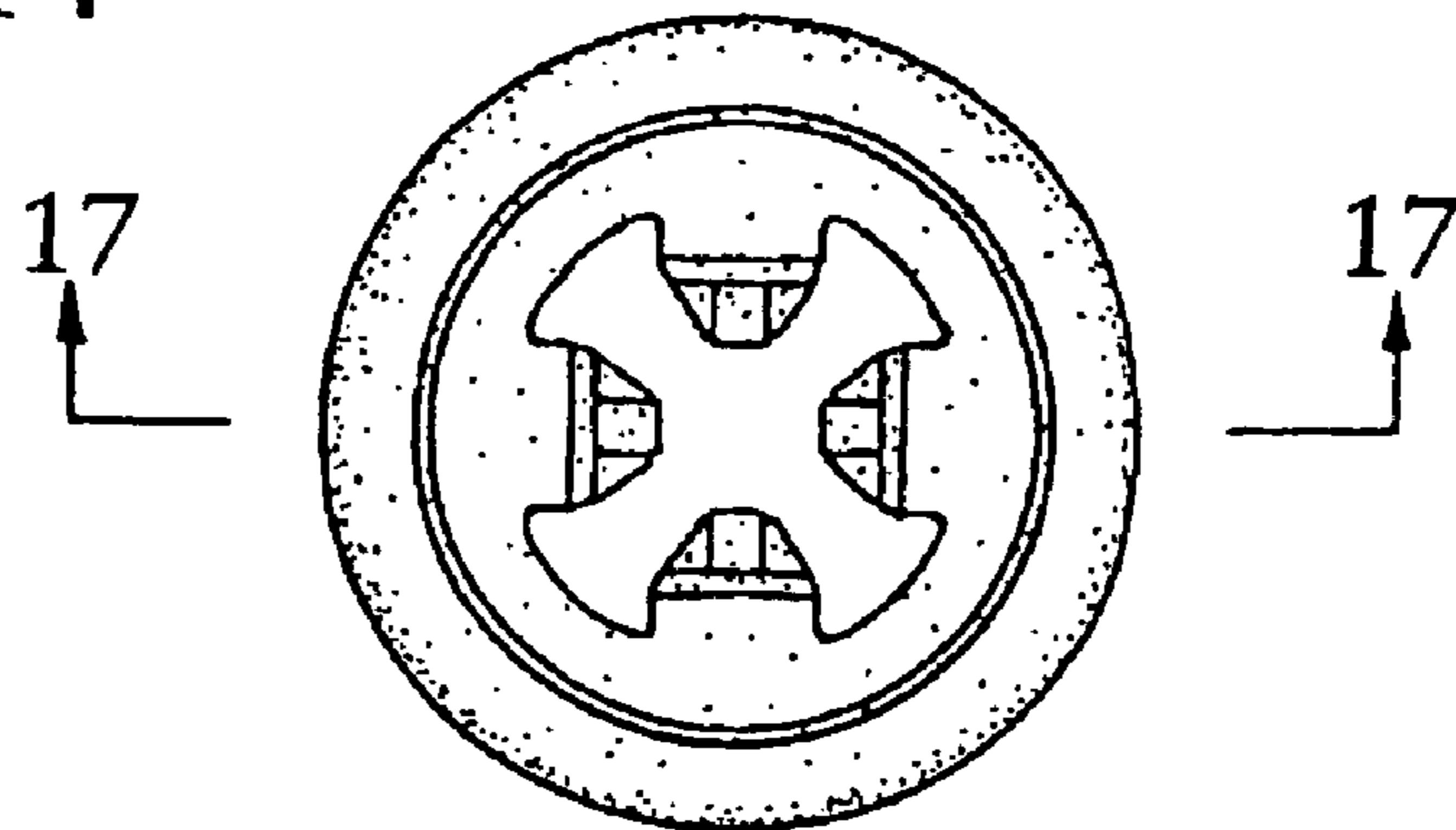

Fig. 15

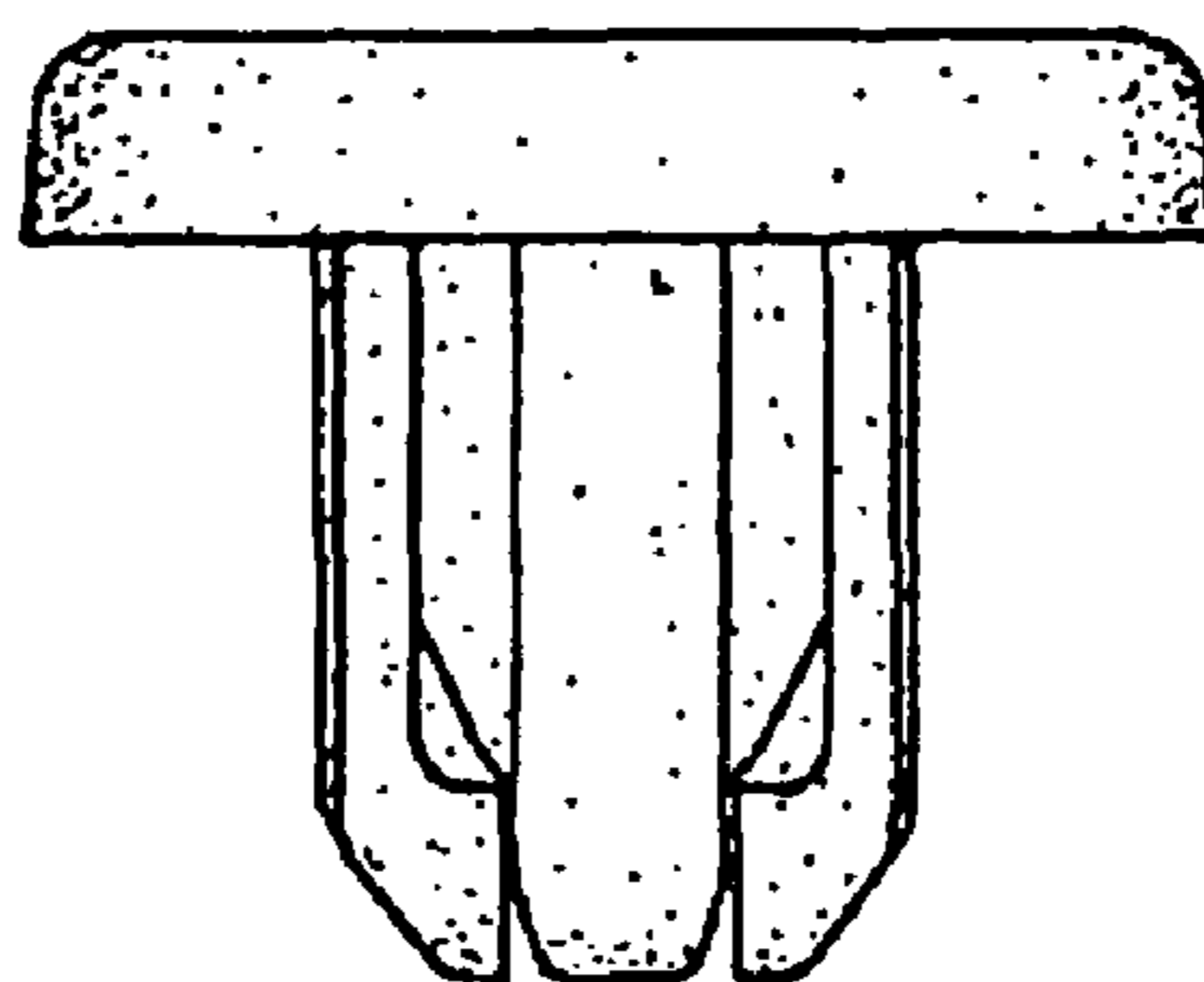

Fig. 16

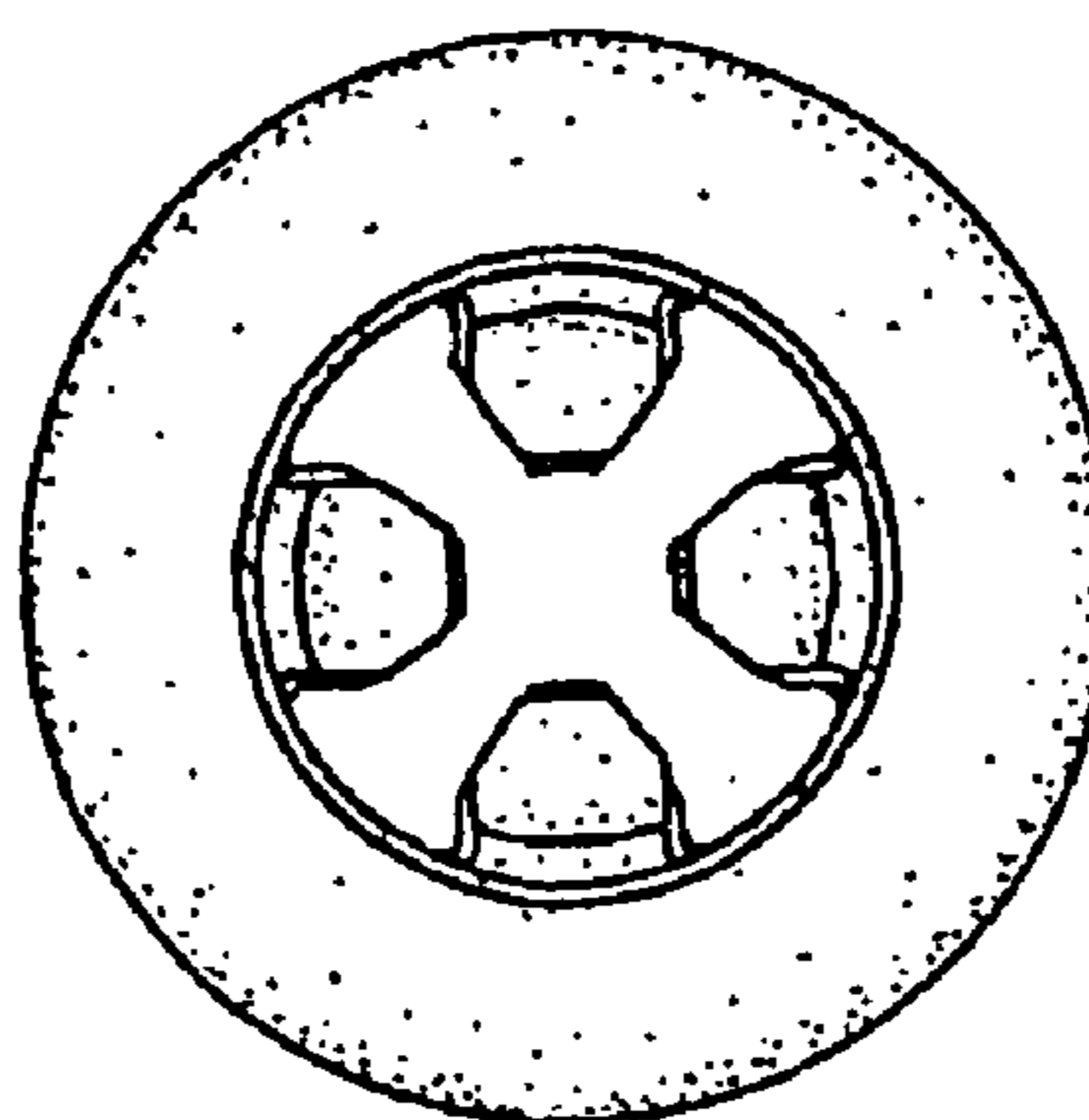

Fig. 17

