



US00D632482S

(12) **United States Design Patent**
Gois

(10) **Patent No.:** **US D632,482 S**

(45) **Date of Patent:** **** Feb. 15, 2011**

(54) **PURSE RING WITH EXTENDED APERTURE**

Primary Examiner—Holly H Baynham

(74) *Attorney, Agent, or Firm*—Nydegger & Associates

(76) **Inventor:** **John F. Gois**, 4803 La Cruz Dr., La Mesa, CA (US) 91941

(57) **CLAIM**

(**) **Term:** **14 Years**

The ornamental design for a purse ring with extended aperture, as shown.

(21) **Appl. No.:** **29/365,128**

(22) **Filed:** **Jul. 2, 2010**

DESCRIPTION

(51) **LOC (9) Cl.** **03-01**

FIG. 1 is a top plan view of the purse ring with its sleeve positioned to establish an enclosed aperture;

(52) **U.S. Cl.** **D3/318**

FIG. 2 is a front view of the purse ring;

(58) **Field of Classification Search** D8/367;
248/301, 304

FIG. 3 is a rear view of the purse ring;

See application file for complete search history.

FIG. 4 is a right side view of the purse ring;

FIG. 5 is a left side view of the purse ring;

(56) **References Cited**

U.S. PATENT DOCUMENTS

5,287,645 A * 2/1994 Gois 43/14

5,505,013 A * 4/1996 Gois 43/14

FIG. 6 is a bottom view of the purse ring; and,

FIG. 7 is a top plan view of the purse ring with its sleeve repositioned to provide access into the aperture.

* cited by examiner

1 Claim, 2 Drawing Sheets

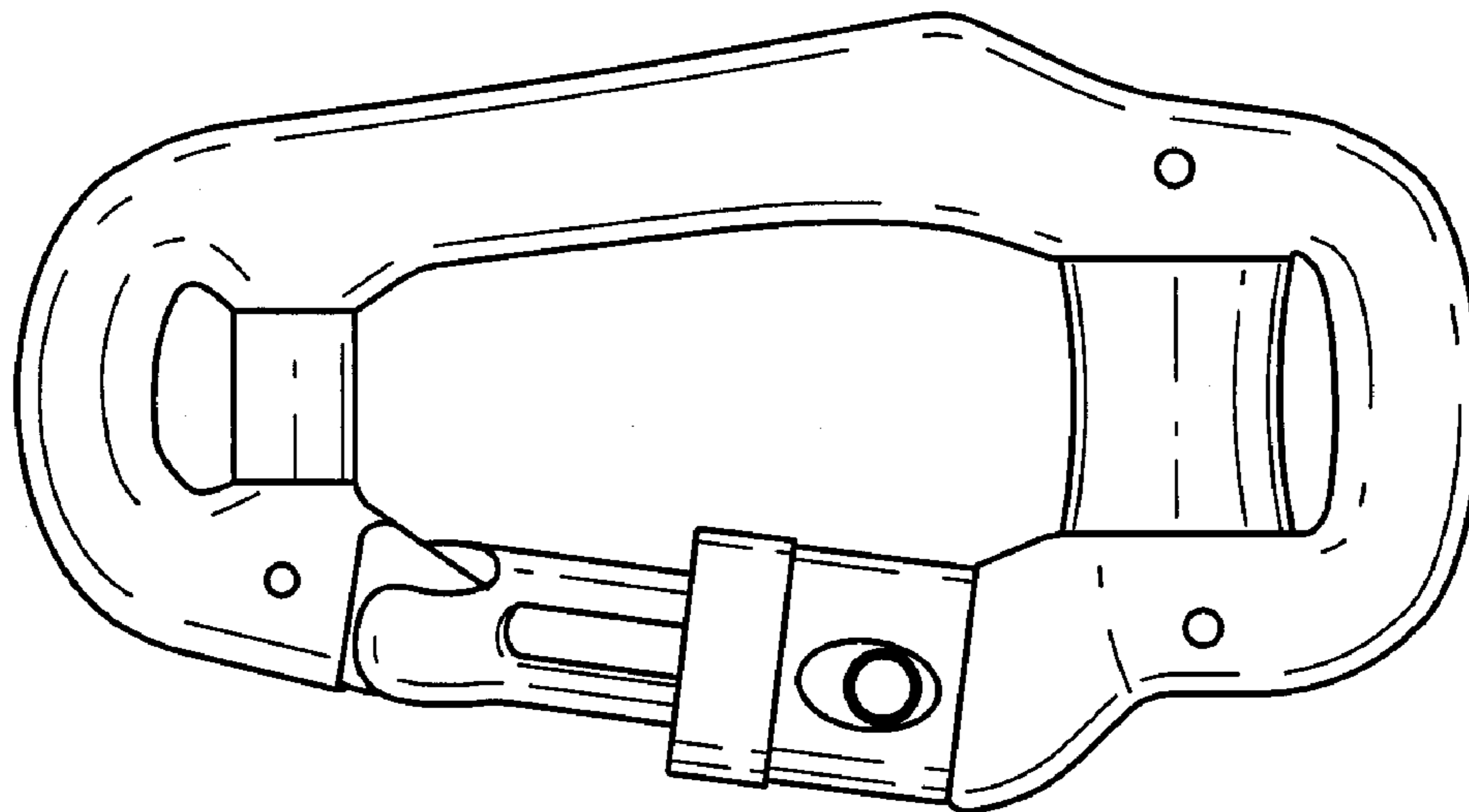

FIG. 1

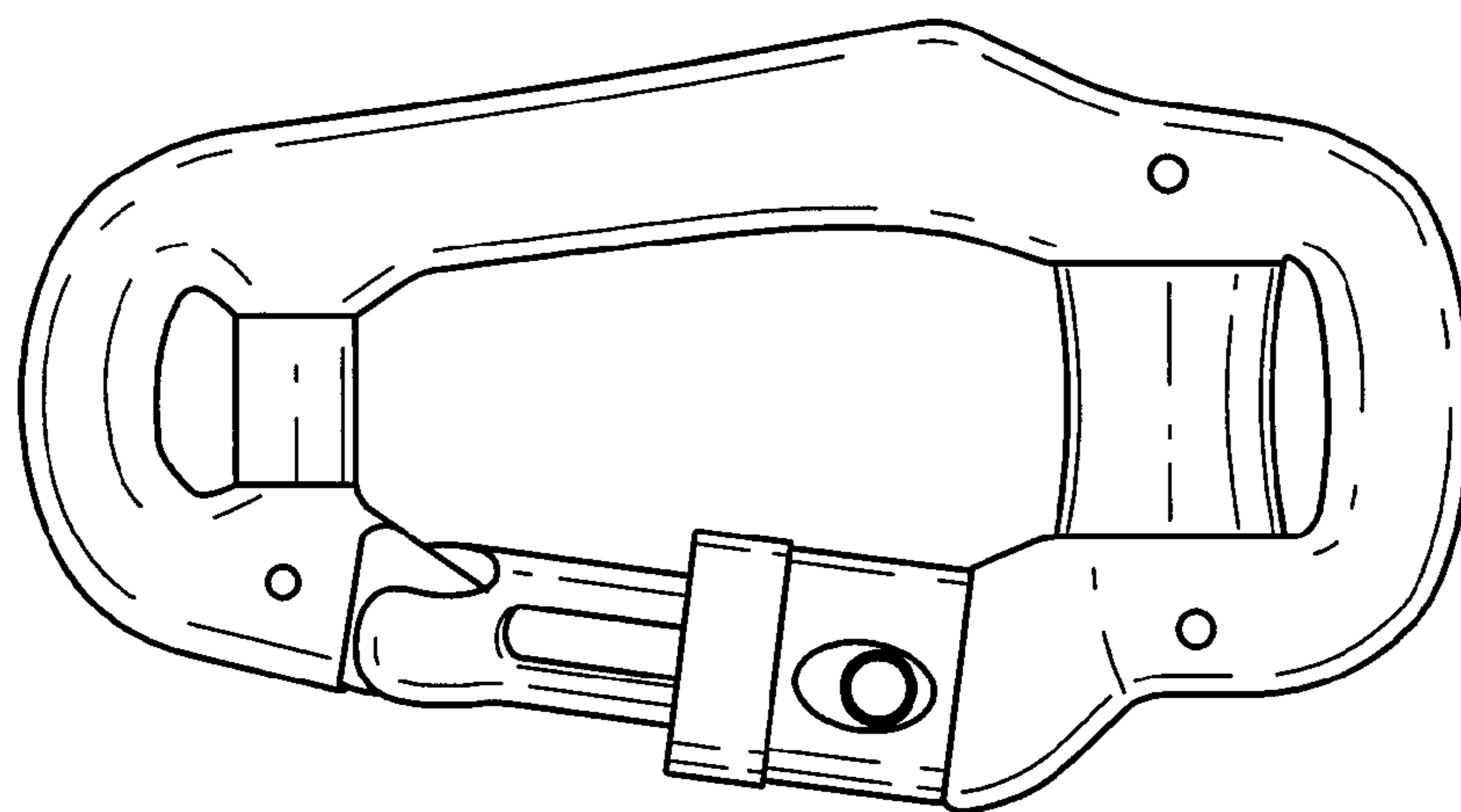

FIG. 2

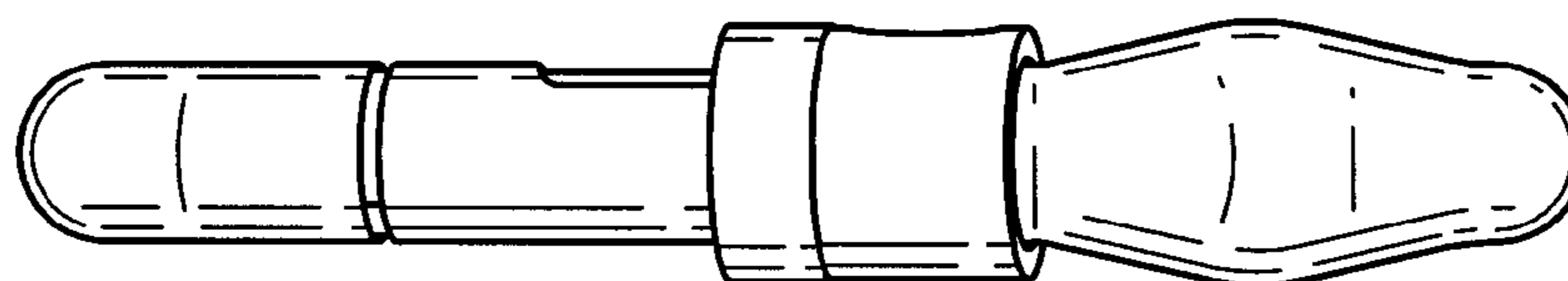

FIG. 3

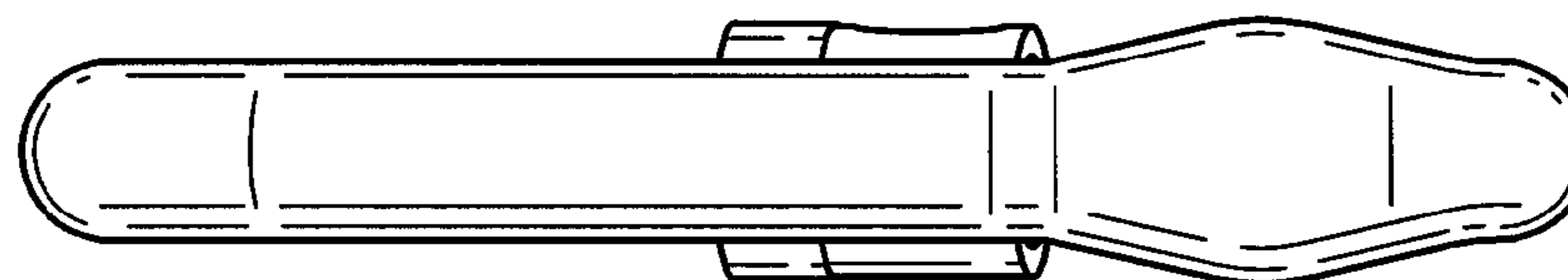

FIG. 4

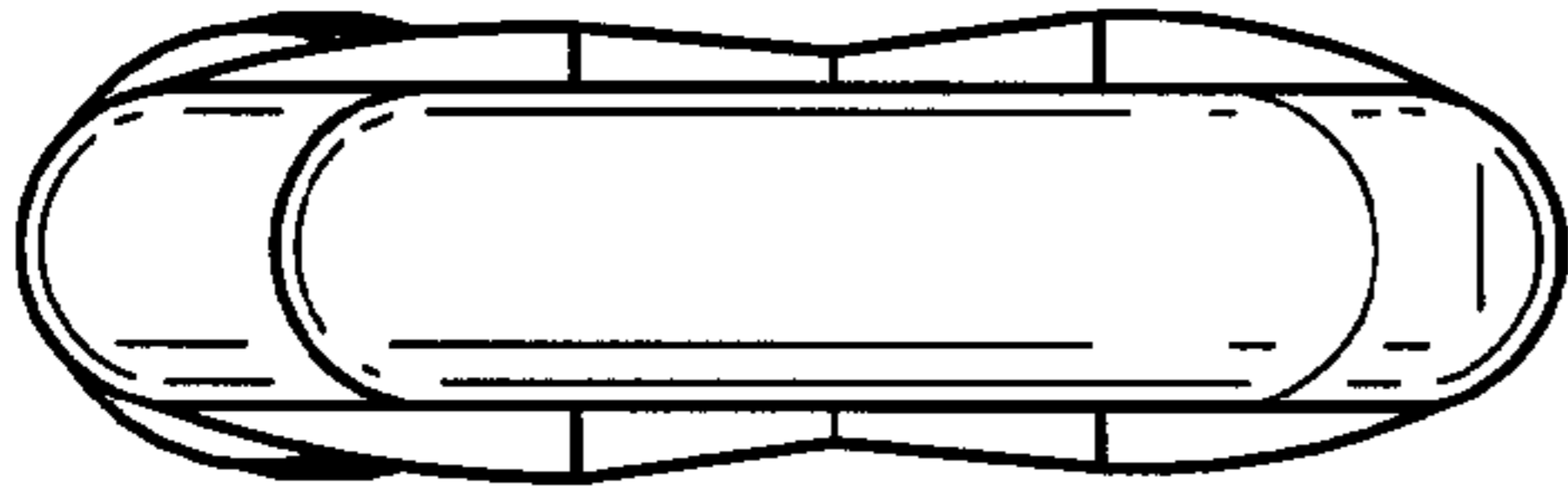

FIG. 5

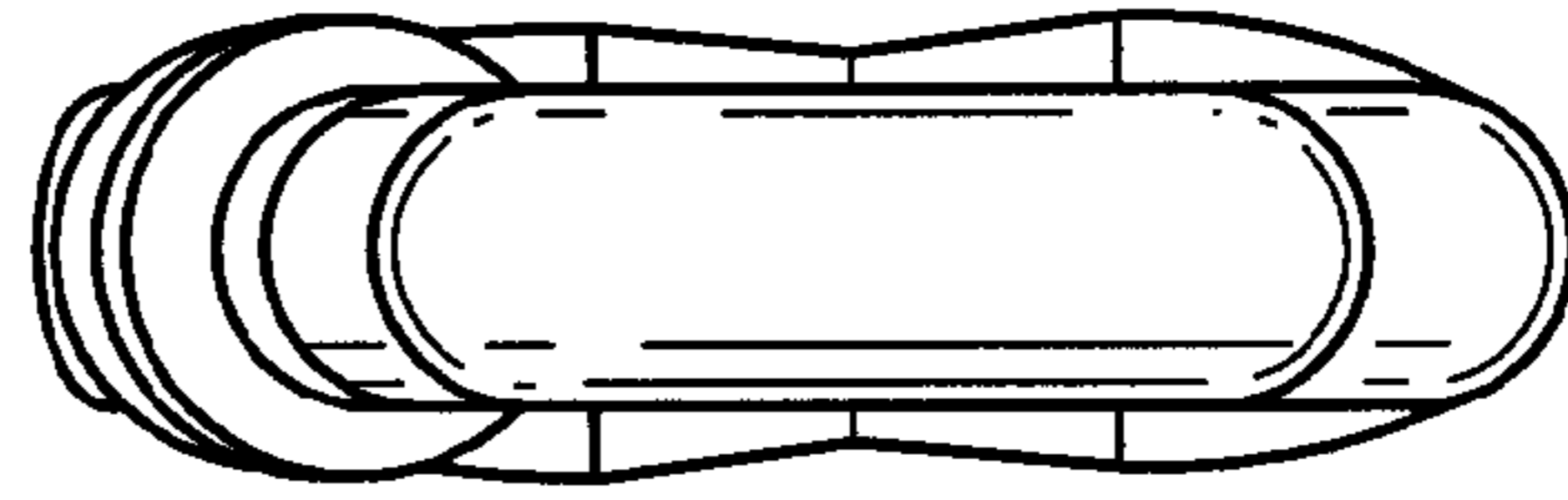

FIG. 6

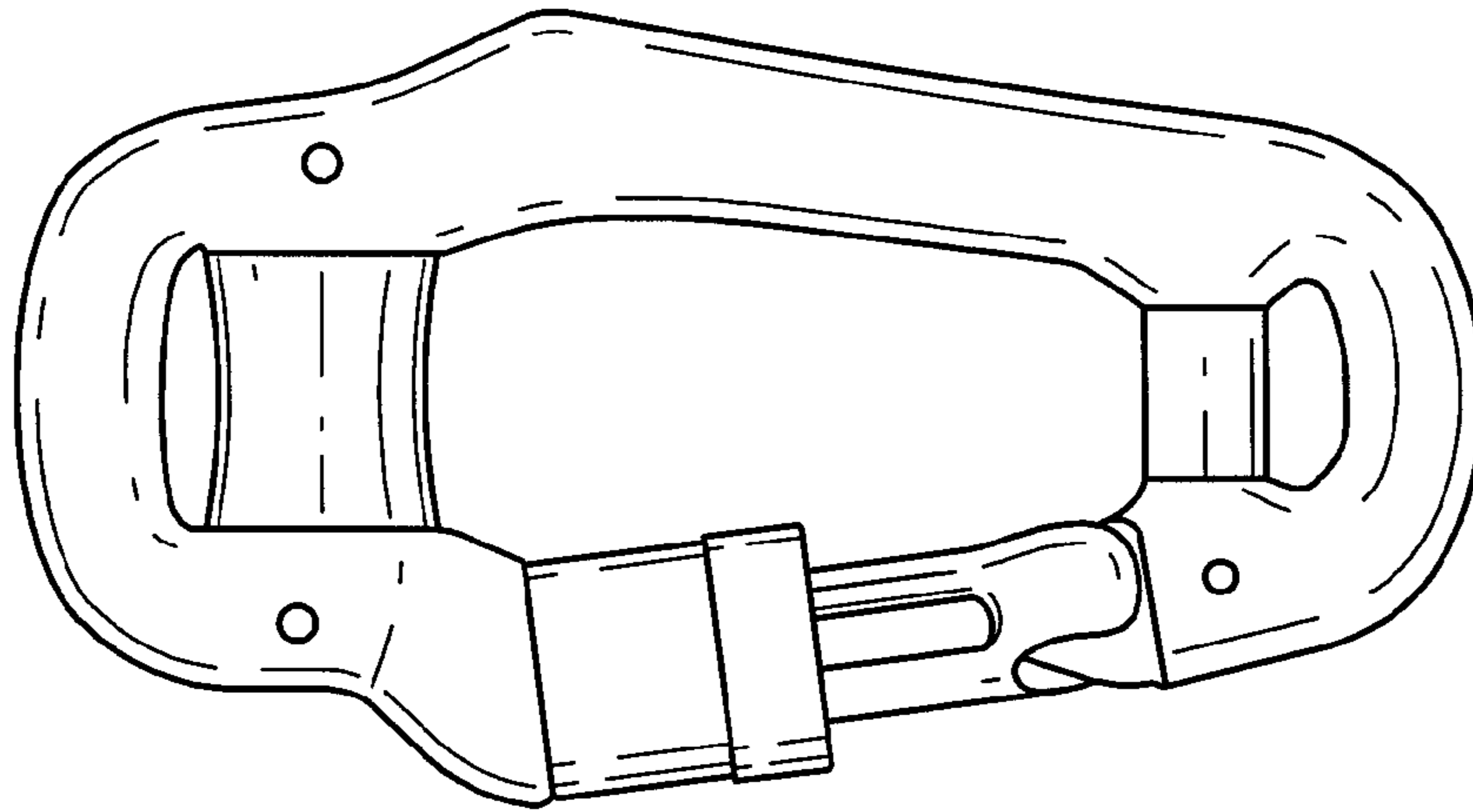

FIG. 7

