



US00D632424S

(12) **United States Design Patent**
Fesler et al.

(10) **Patent No.:** **US D632,424 S**
(45) **Date of Patent:** **** Feb. 8, 2011**

(54) **REAR TAIL LIGHT BEZEL FOR VEHICLE BODY**

(75) Inventors: **Carrie Ann Fesler**, Phoenix, AZ (US);
Christopher Lampert Fesler, Phoenix, AZ (US)

(73) Assignee: **Fesler Productions, LLC**, Scottsdale, AZ (US)

(**) Term: **14 Years**

(21) Appl. No.: **29/360,946**

(22) Filed: **May 3, 2010**

(51) **LOC (9) Cl.** **26-99**

(52) **U.S. Cl.** **D26/139**

(58) **Field of Classification Search** D26/28-36,
D26/139; 362/61, 80, 81, 82, 83, 325, 376
See application file for complete search history.

(56) **References Cited**

U.S. PATENT DOCUMENTS

D316,461 S	4/1991	McGlothlin	
D355,039 S *	1/1995	Winick	D26/139
D387,469 S	12/1997	Saleen	
D432,064 S	10/2000	Hartog	
D440,694 S *	4/2001	Jeffries	D26/139
D494,706 S *	8/2004	Tsai	D26/139
D571,500 S *	6/2008	Lin	D26/139
D584,196 S	1/2009	Ebel et al.	
D587,175 S	2/2009	Bauer et al.	
D596,540 S	7/2009	Hayashi et al.	
D603,755 S	11/2009	Peters	
D608,249 S	1/2010	Peters	

OTHER PUBLICATIONS

Excerpt from Chevrolet.com website regarding "All New Camaro". [online]. General Motors, 2010 [retrieved on May 4, 2010]. Retrieved from the Internet: <URL: http://www.chevrolet.com/vehicles/2010/camaro/overview.do?seo=goo_|_2008_Chevy_Retention_|_IMG_2009_Chevy_Camaro_|_Camaro_2010_|_2010_chevrolet_camaro>.

Excerpt from Chevrolet.com website—photo-captioned "The RS Package features sinister-looking taillamps", Close-up photo of rear tail light of 2010 Chevy Camaro Coupe [online]. General Motors, 2010 [retrieved on May 4, 2010]. Retrieved from the Internet: <URL: <http://www.chevrolet.com/camaro-car/pictures/>>.

Excerpt from Chevrolet.com website—photo-captioned "LT in Silver Ice Metallic with available RS Package", Photo of rear tail light of 2010 Chevy Camaro Coupe [online]. General Motors, 2010 [retrieved on May 4, 2010]. Retrieved from the Internet: <URL: <http://www.chevrolet.com/camaro-car/pictures/>>.

(Continued)

Primary Examiner—Marcus A Jackson

(74) *Attorney, Agent, or Firm*—Fennemore Craig, P.C.; Susan Stone Rosenfield

(57) **CLAIM**

The ornamental design for a rear tail light bezel for vehicle body, as shown and described.

DESCRIPTION

FIG. 1 is a front perspective view of the first embodiment of a rear tail light bezel for a vehicle body; the second embodiment, which is omitted for convenience of illustration, is understood to be a minor image of the first embodiment;

FIG. 2 is an enlarged front perspective view of the first embodiment;

FIG. 3 is a rear perspective view thereof;

FIG. 4 is a front elevational view thereof;

FIG. 5 is a rear elevational view thereof;

FIG. 6 is a top plan view thereof;

FIG. 7 is a bottom plan view thereof;

FIG. 8 is a right side elevational view thereof; and,

FIG. 9 is a left side elevational view thereof.

The vehicle portions show in broken lines are for illustrative purposes only and form no part of the claimed design.

1 Claim, 7 Drawing Sheets

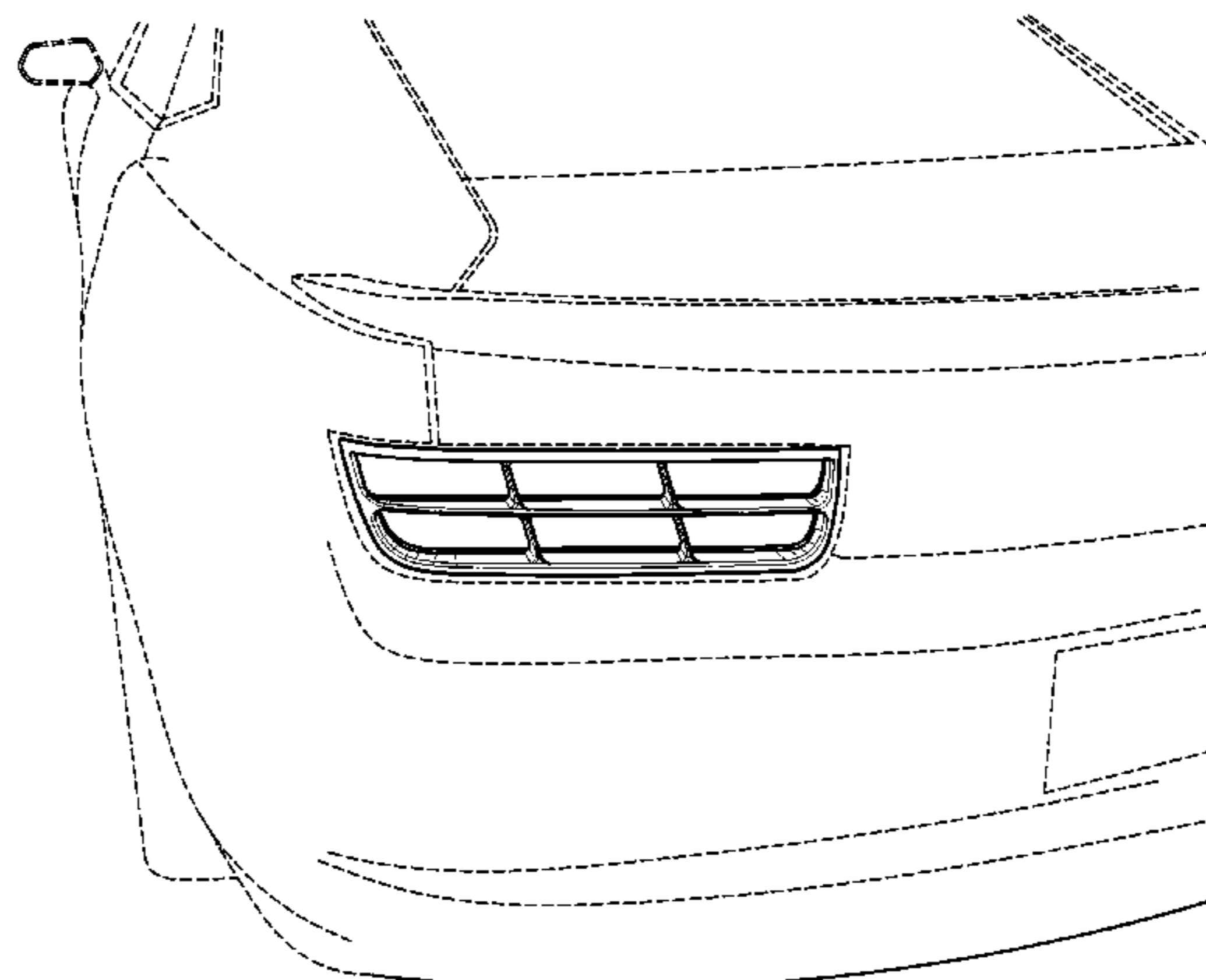

OTHER PUBLICATIONS

2010 Chevrolet Camaro Brochure, dated Mar. 2009, [retrieved on Aug. 12, 2010]. Retrieved from the Internet <URL: <http://www.chevrolet.com/assets/en/pdf/brochures/Camaro.pdf>>.

Excerpt from Chevrolet.com website regarding “All New Camaro” [online]. General Motors, 2010 [retrieved on May 4, 2010]. Retrieved from the Internet: <URL: http://www.chevrolet.com/vehicles/2010/camaro/overview.do?seo=goo_|_2008_Chevy_Retention_|_IMG_2009_Chevy_Camaro_|_Camaro_2010_|_2010_chevrolet_camaro> [shows photos of the 2010 Chevy Camaro, which was first released on or about Mar. 2009].

Excerpt from Chevrolet.com website—photo-captioned “The RS Package features sinister-looking taillamps”, Close-up photo of rear

tail light of 2010 Chevy Camaro Coupe [online]. General Motors, 2010 [retrieved on May 4, 2010]. Retrieved from the Internet: <URL: <http://www.chevrolet.com/camaro-car/pictures/>>. [shows photos of the 2010 Chevy Camaro, which was first released on or about Mar. 2009].

Excerpt from Chevrolet.com website—photo-captioned “LT in Silver Ice Metallic with available RS Package”, Photo of rear tail light of 2010 Chevy Camaro Coupe [online]. General Motors, 2010 [retrieved on May 4, 2010]. Retrieved from the Internet: <URL: <http://www.chevrolet.com/camaro-car/pictures/>>. [shows photos of the 2010 Chevy Camaro, which was first released on or about Mar. 2009].

* cited by examiner

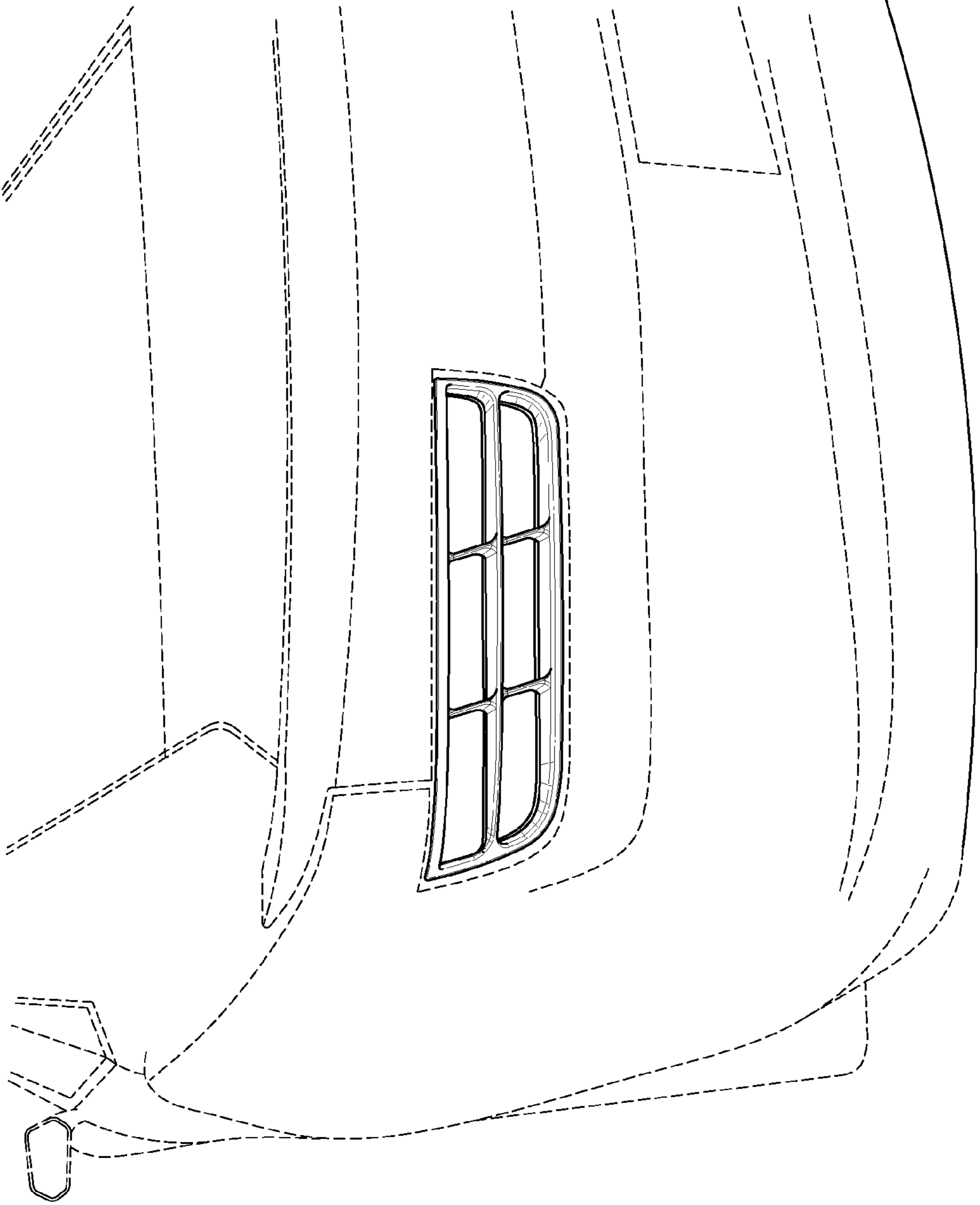

FIG. 1

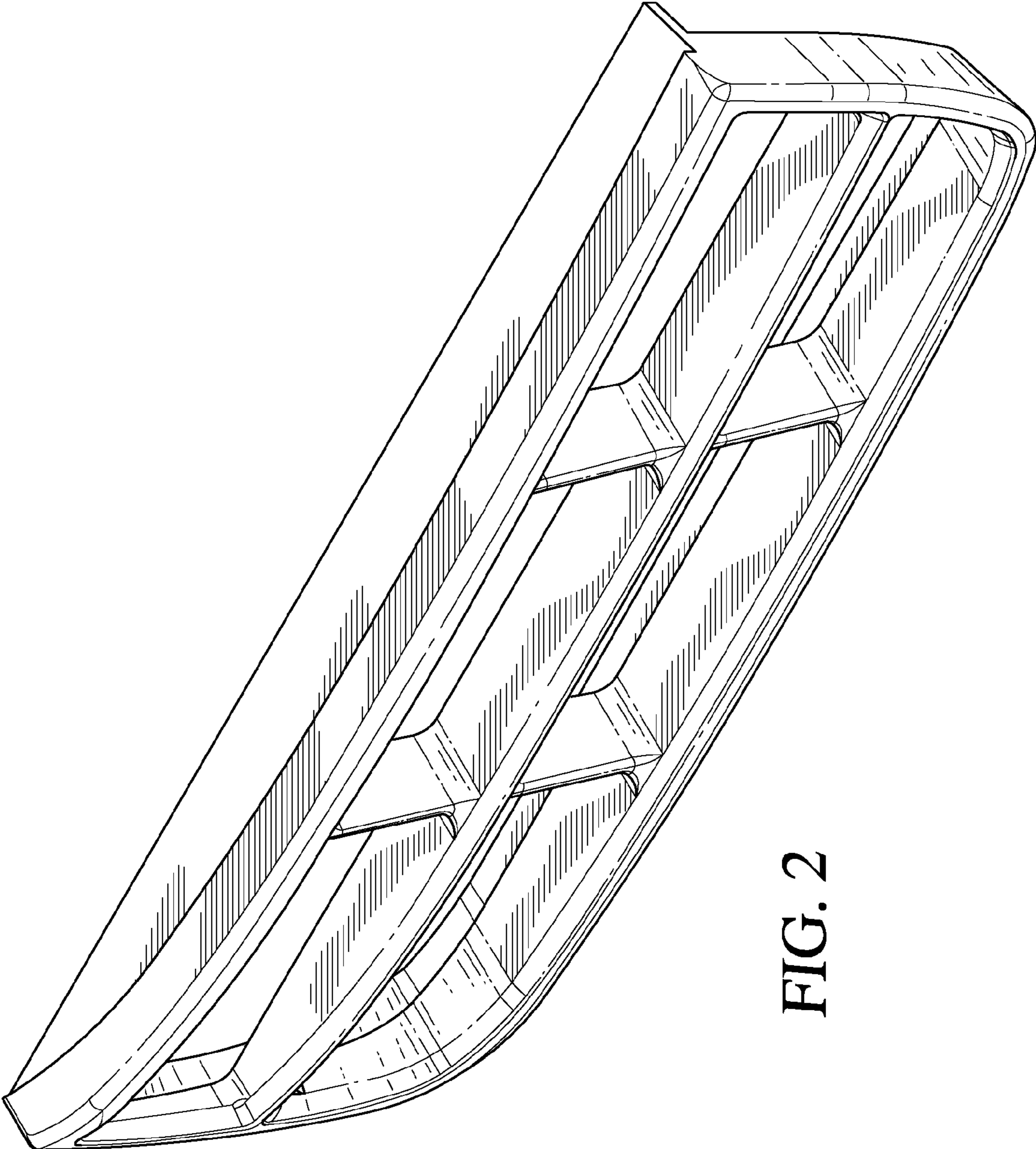

FIG. 2

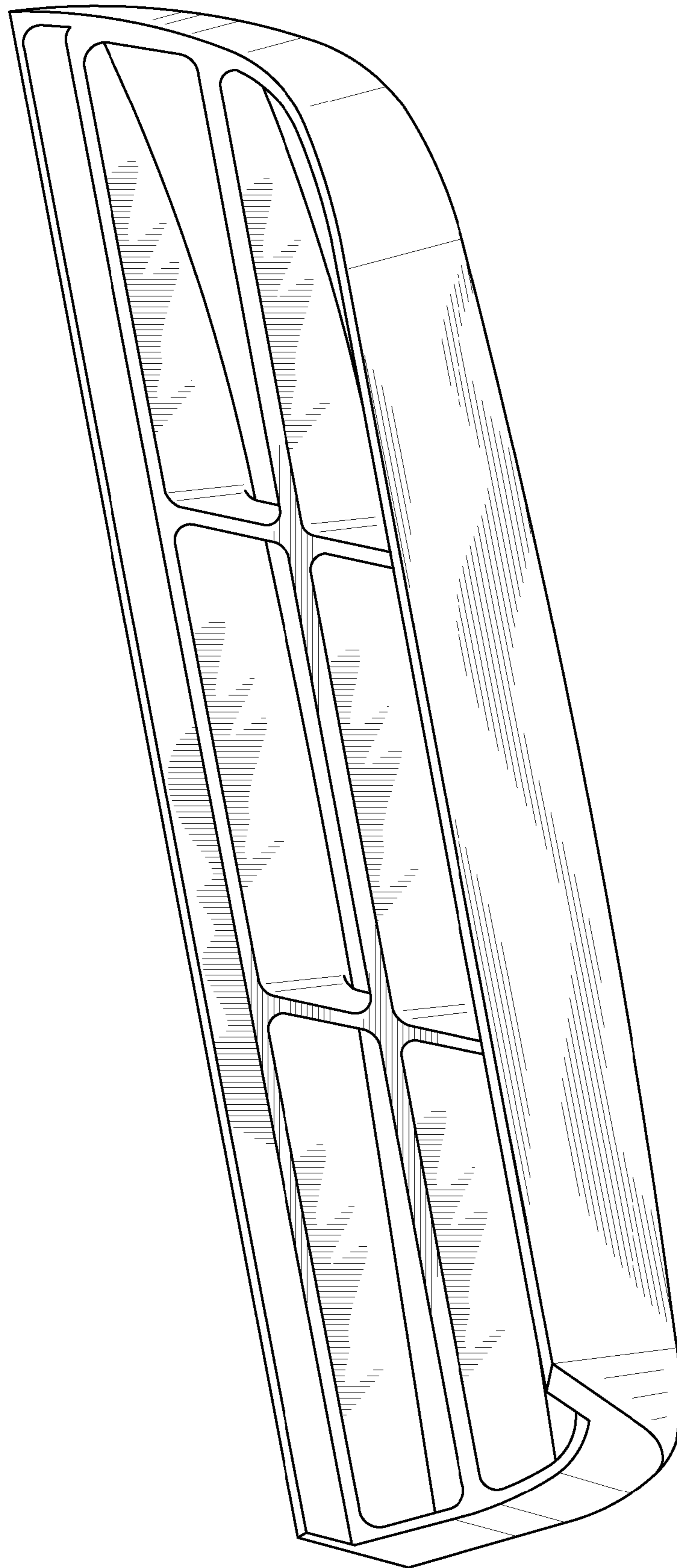

FIG. 3

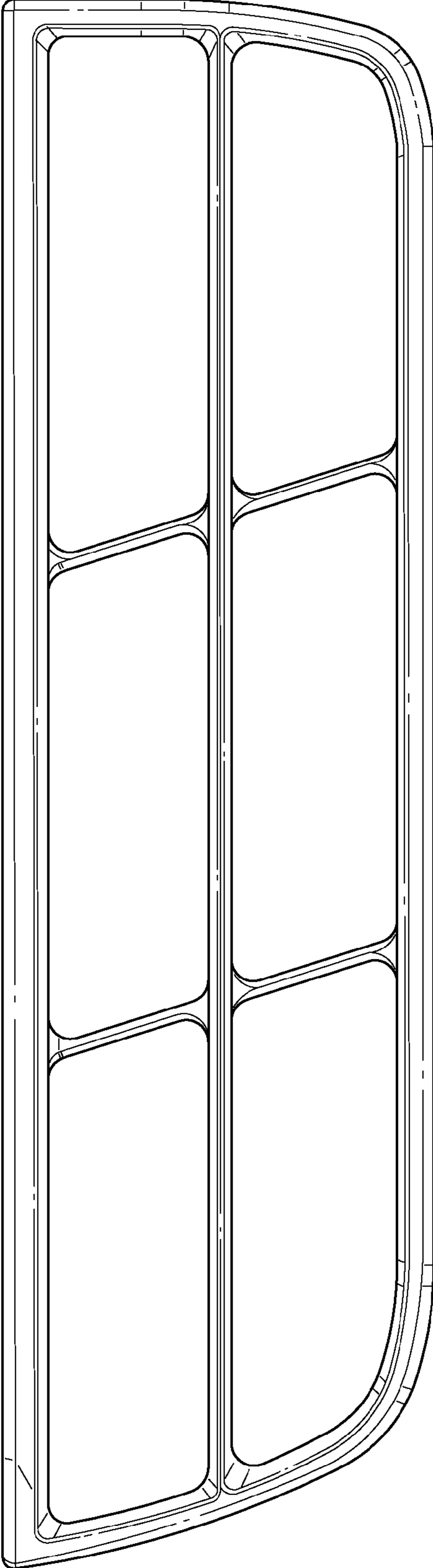

FIG. 4

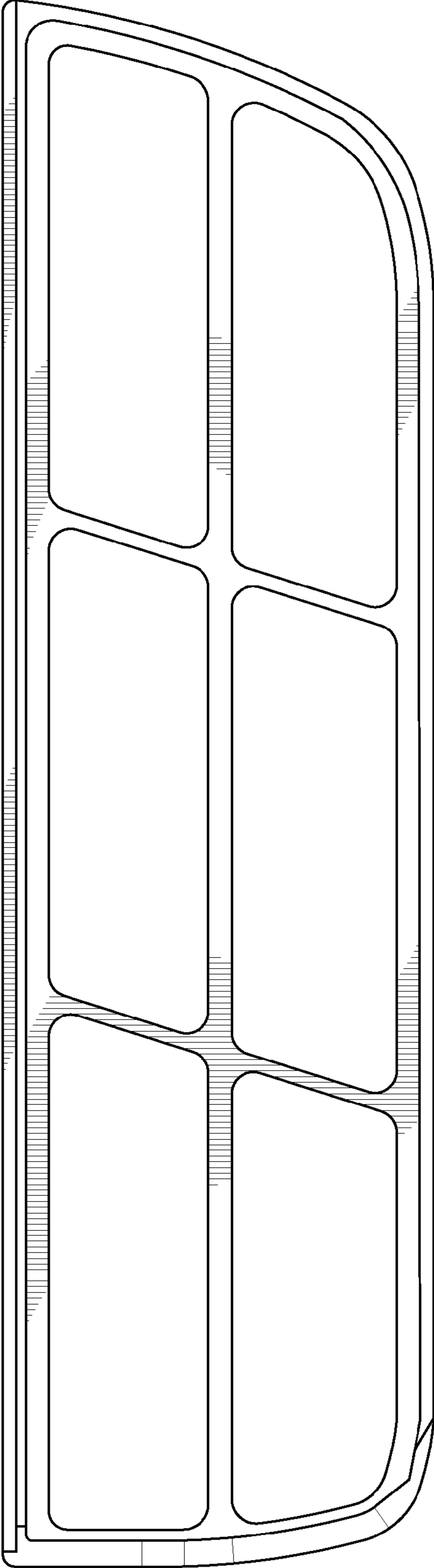

FIG. 5

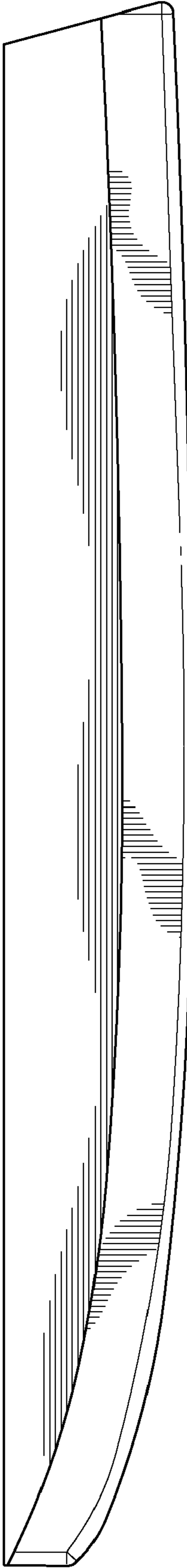

FIG. 6

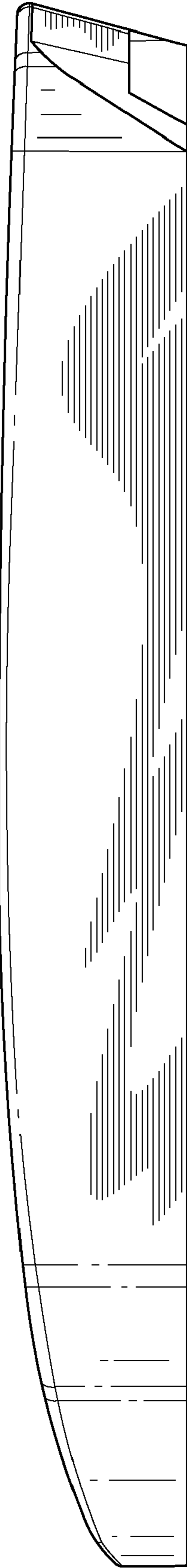

FIG. 7

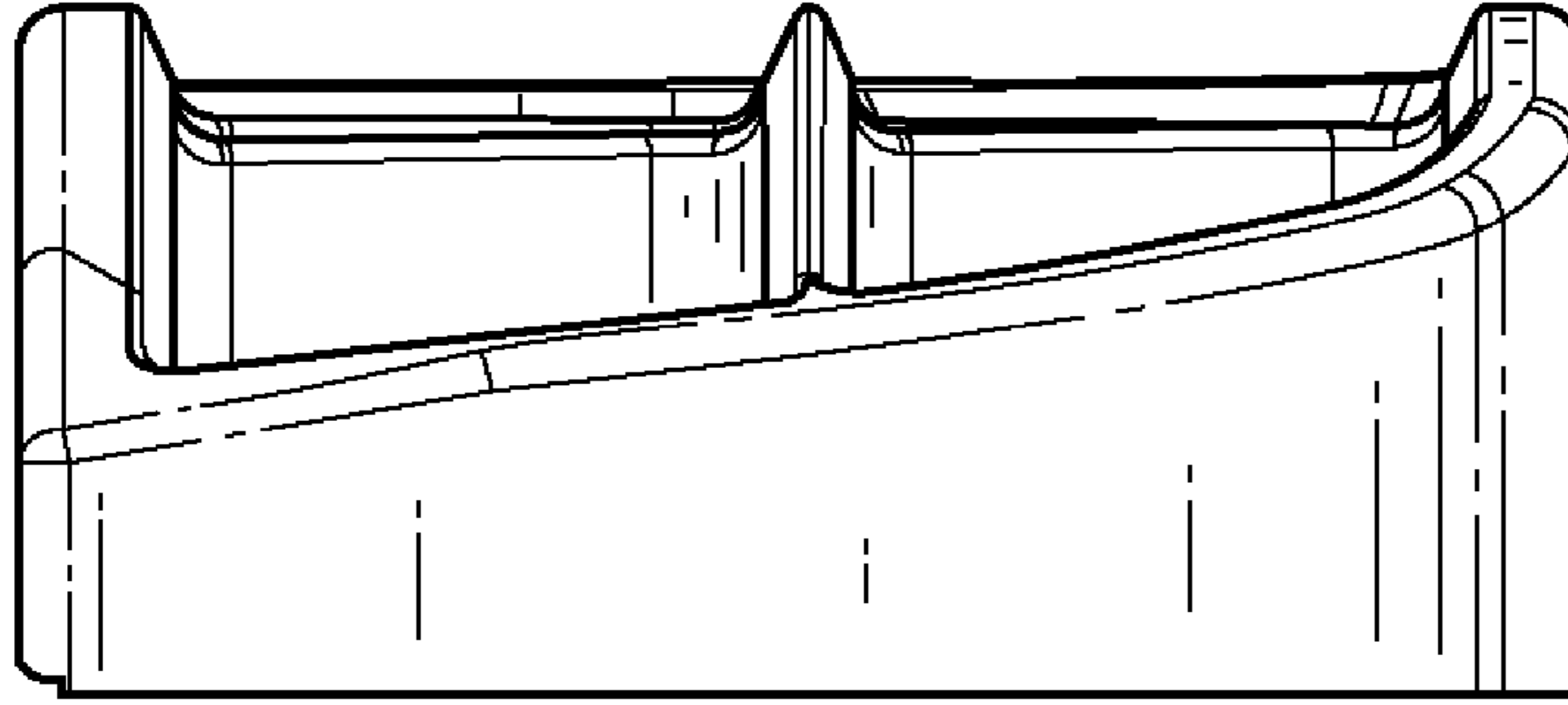

FIG. 9

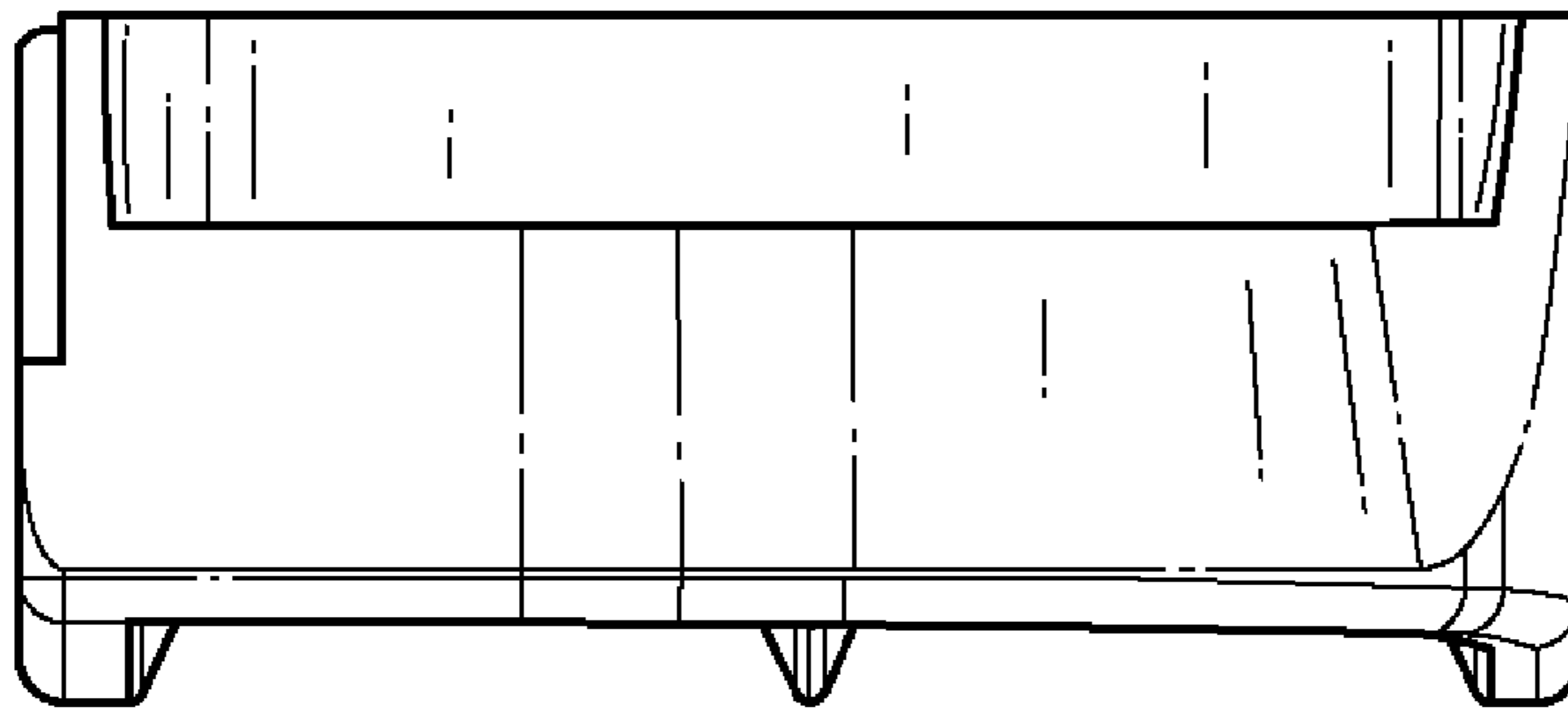

FIG. 8