



US00D632377S

(12) **United States Design Patent**
Blachford et al.

(10) **Patent No.:** **US D632,377 S**

(45) **Date of Patent:** **** Feb. 8, 2011**

(54) **AIR FRESHENER DEVICE**

(75) Inventors: **Marcus Blachford**, Warwick (GB);
James Holt, Warwick (GB); **David Law**,
Warwick (GB); **Tom Peach**, Warwick
(GB); **Tim Sharpe**, Warwick (GB)

(73) Assignee: **Reckitt & Colman (Overseas) Limitd**,
Slough, Berkshire (GB)

(**) Term: **14 Years**

(21) Appl. No.: **29/359,232**

(22) Filed: **Apr. 7, 2010**

(30) **Foreign Application Priority Data**

Jan. 22, 2010 (EM) 001660275-0001

(51) **LOC (9) Cl.** **28-99**

(52) **U.S. Cl.** **D23/366**

(58) **Field of Classification Search** D23/355-369;
D28/5, 6; 261/DIG. 17, DIG. 42, DIG. 65,
261/DIG. 88, DIG. 89; 392/386, 390, 391,
392/392, 394, 395, 389, 393; 239/34, 35,
239/43-45, 53, 56, 57, 60, 326, 42, 50, 55
See application file for complete search history.

(56) **References Cited**

U.S. PATENT DOCUMENTS

D338,522 S * 8/1993 Muderlak D23/366
D358,090 S * 5/1995 Morikawa D6/553
D363,981 S * 11/1995 Muderlak D23/366
D372,966 S * 8/1996 Chen D23/366
D406,330 S * 3/1999 Chen D23/366

D407,477 S * 3/1999 Chen D23/366
D409,740 S * 5/1999 Gallagher et al. D23/366
D413,663 S * 9/1999 Chen D23/366
D425,190 S * 5/2000 Morikawa D23/366
D439,320 S * 3/2001 Lee D23/366
D468,627 S * 1/2003 Dampney D9/693
D471,970 S * 3/2003 Gallagher et al. D23/366
D533,931 S * 12/2006 Miller et al. D23/366
D573,706 S * 7/2008 Zlotnik et al. D23/366
D604,824 S * 11/2009 Paolazzi et al. D23/366

* cited by examiner

Primary Examiner—Sandra Snapp

(74) *Attorney, Agent, or Firm*—Norris McLaughlin &
Marcus, PA

(57) **CLAIM**

The ornamental design for an air freshener device, as shown
and described.

DESCRIPTION

FIG. 1 is a front perspective view of our air freshener device;
FIG. 2 is a front elevational view thereof;
FIG. 3 is a rear elevational view thereof;
FIG. 4 is a right side elevational view thereof;
FIG. 5 is a left side elevational view thereof
FIG. 6 is a top plan view thereof; and,
FIG. 7 is a bottom plan view thereof.

The broken lines shown in the drawing views are included for
illustrative purposes only, and form no part of the claimed
design.

1 Claim, 6 Drawing Sheets

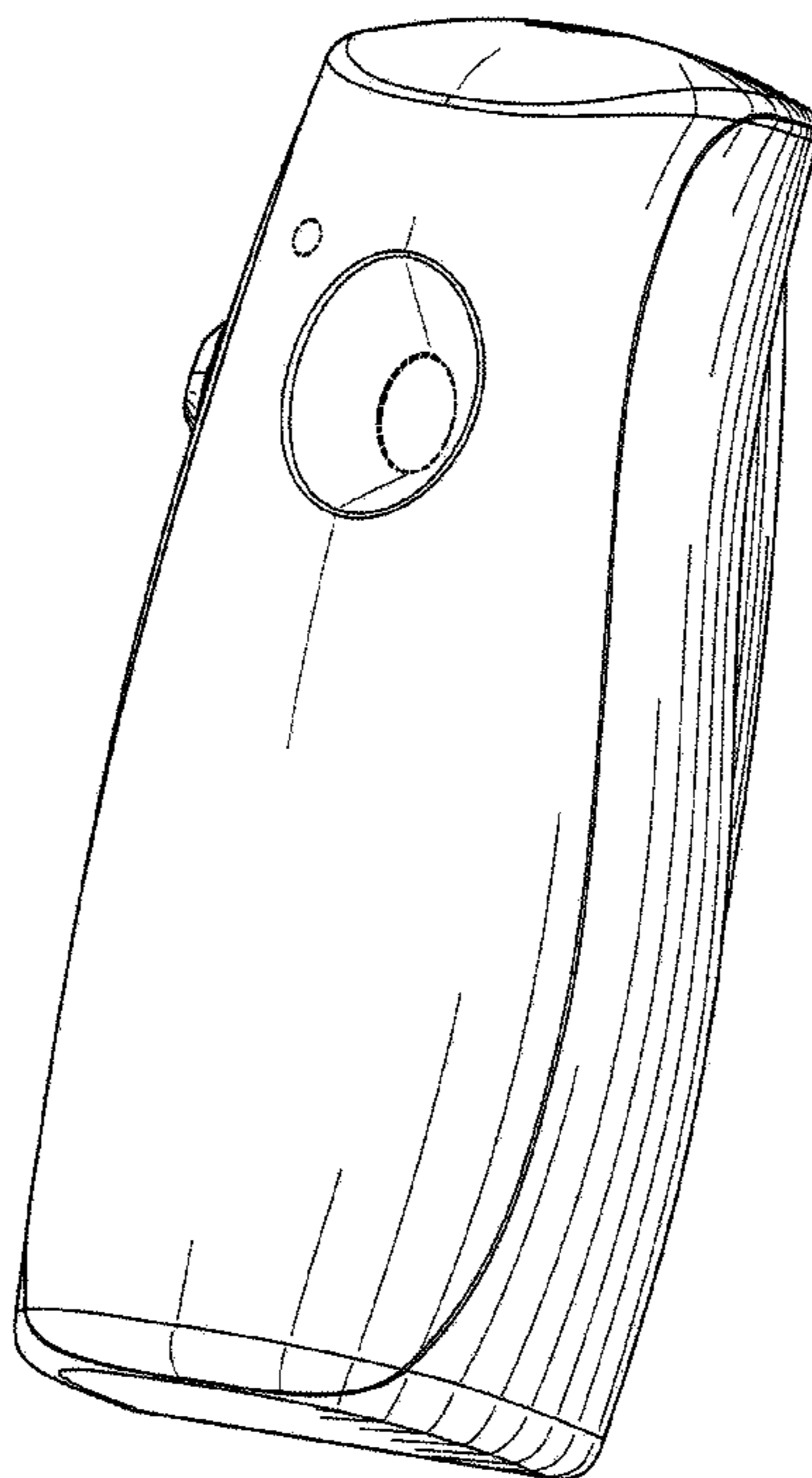

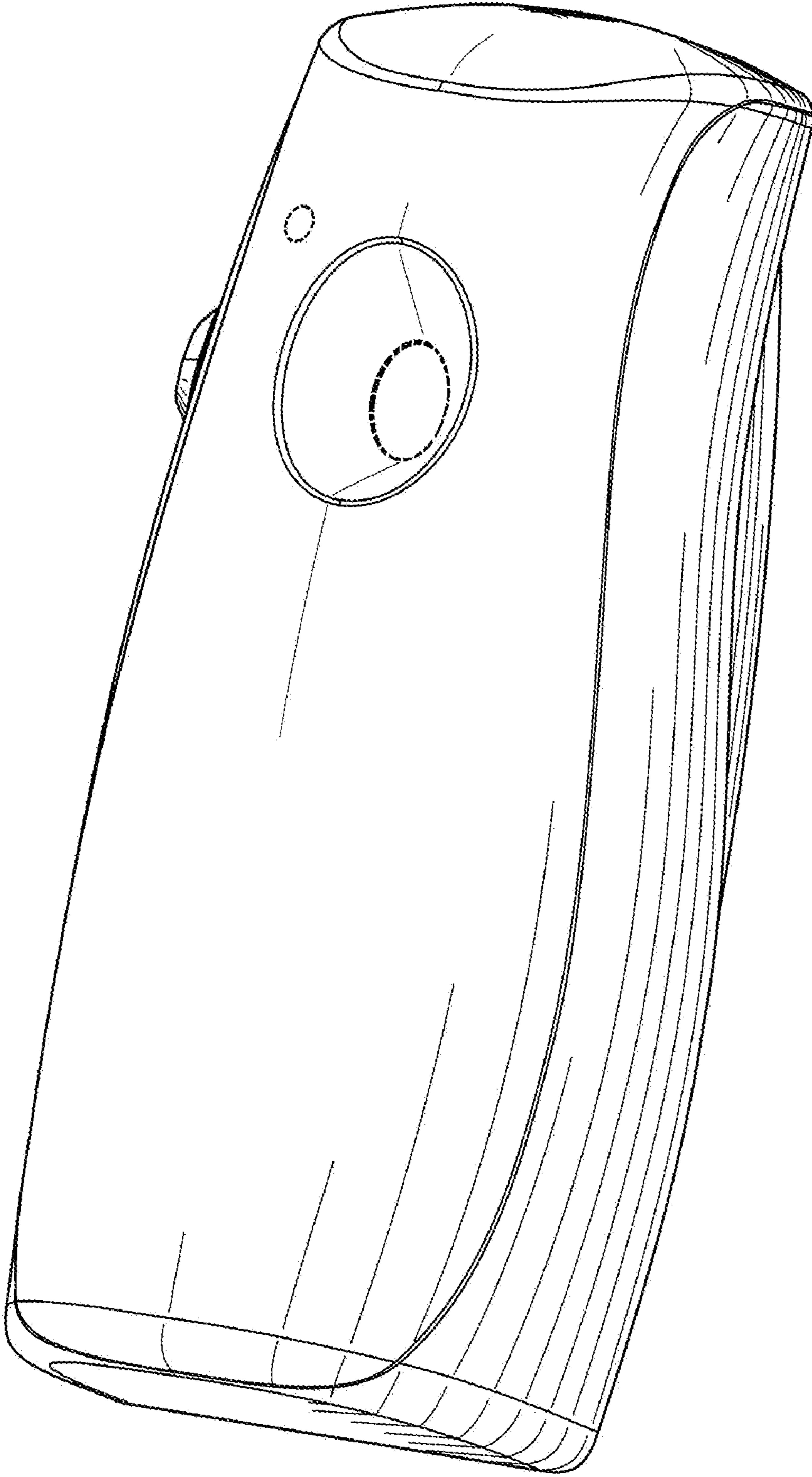

Fig.1

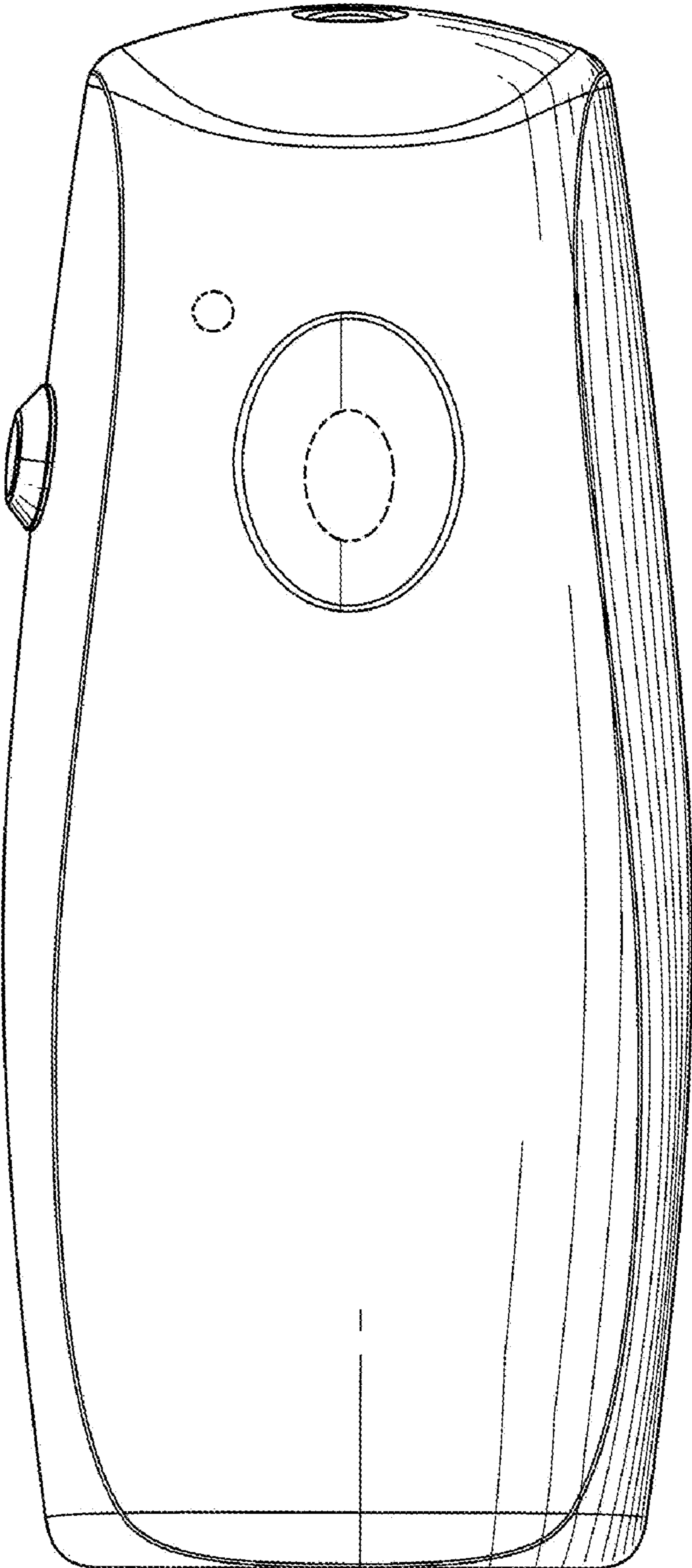

Fig.2

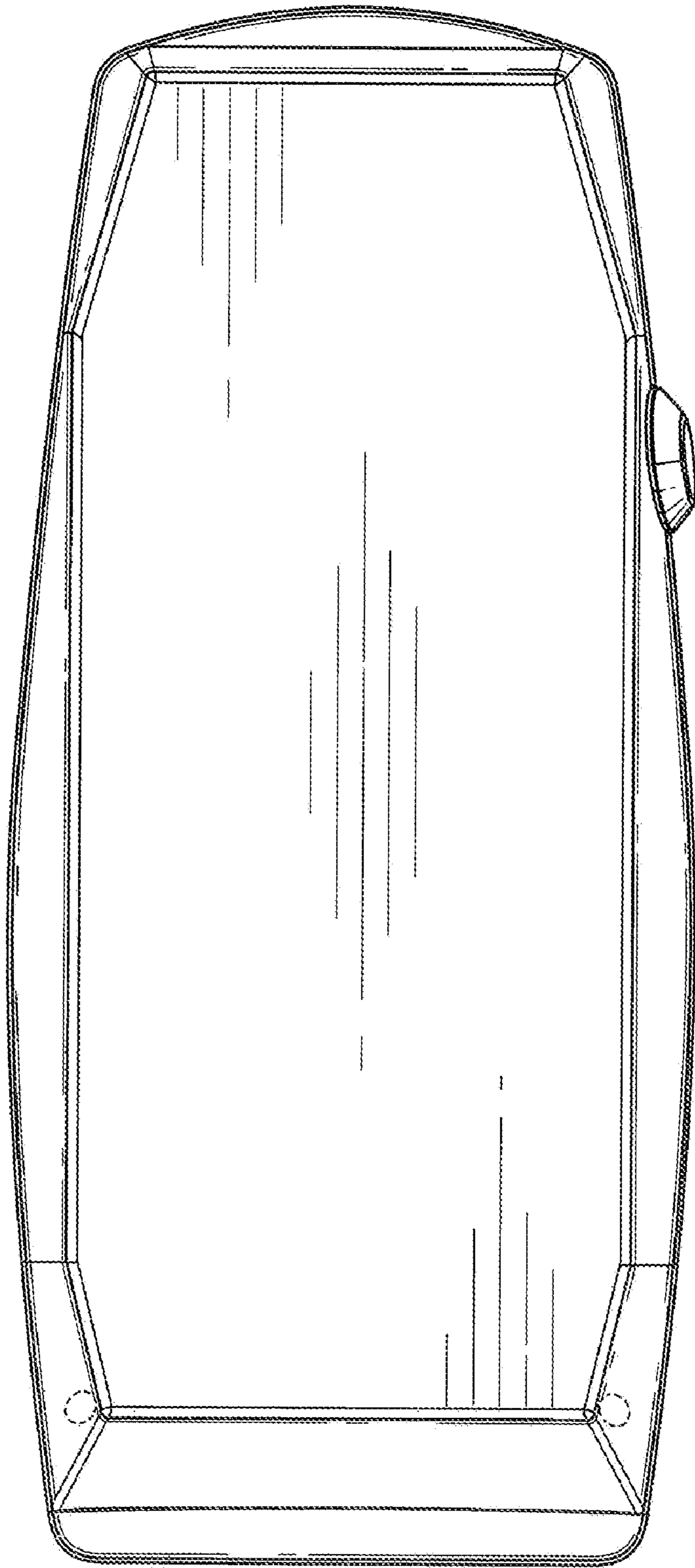

Fig.3

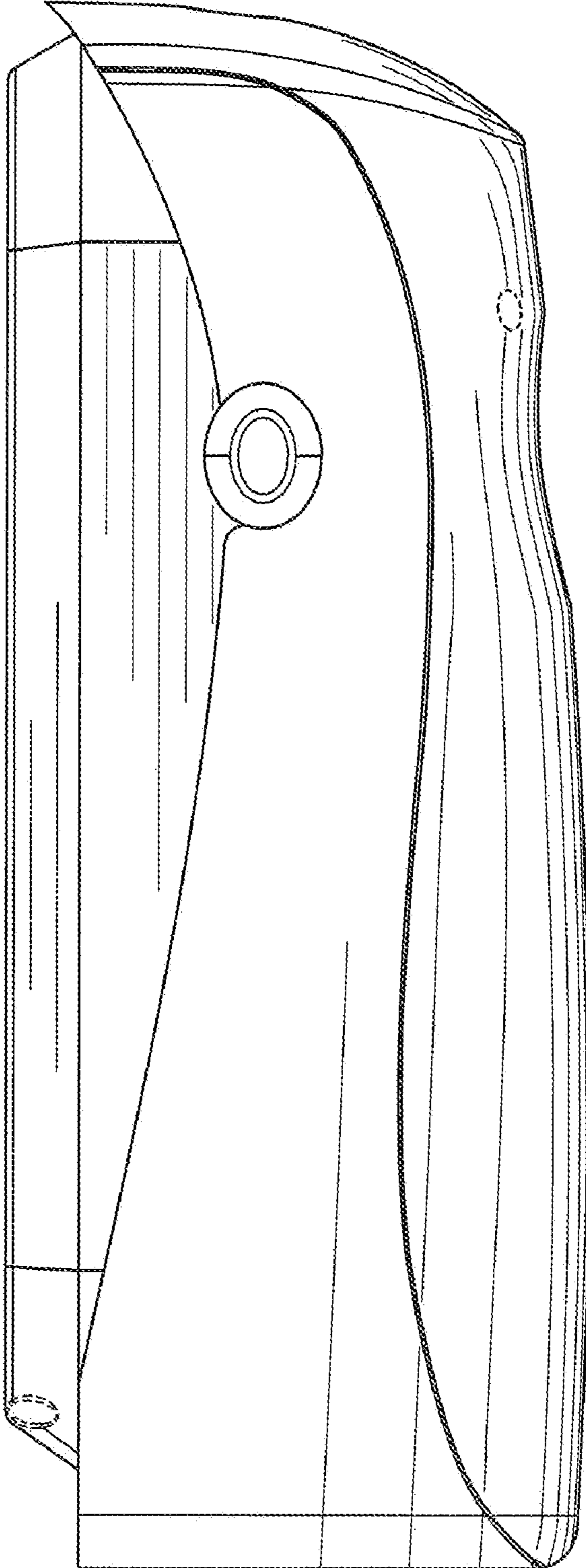

Fig.4

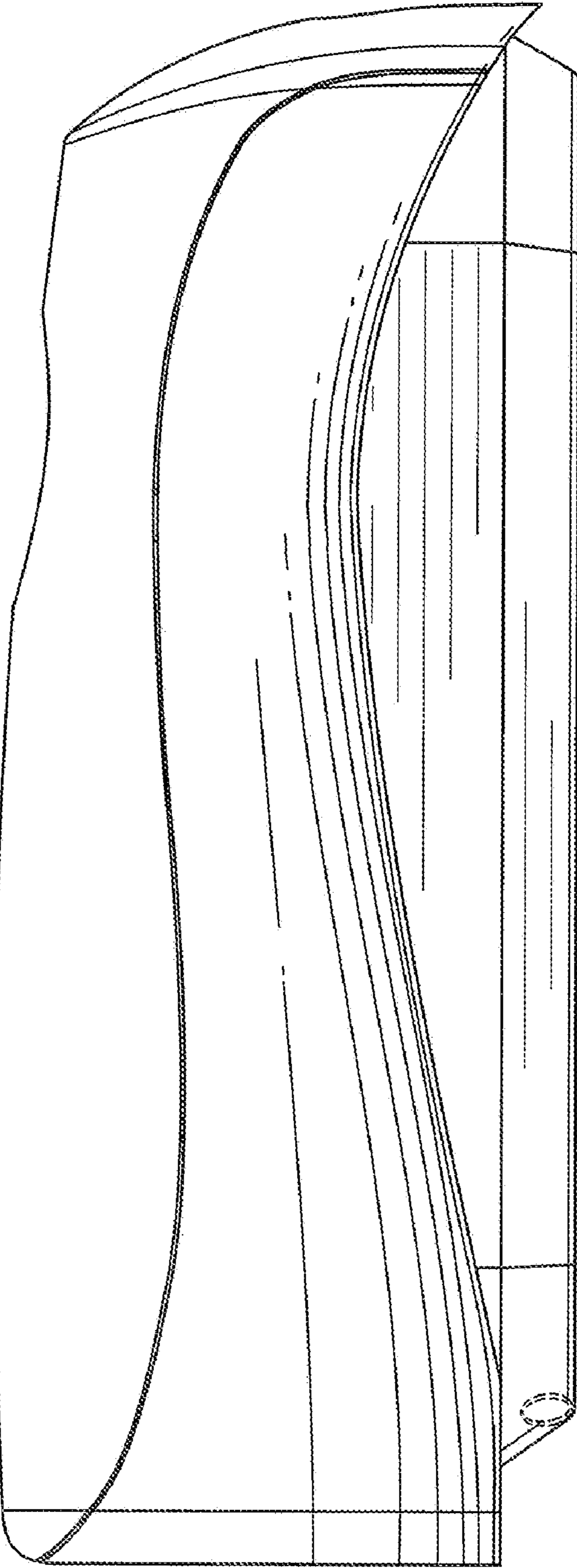

Fig.5

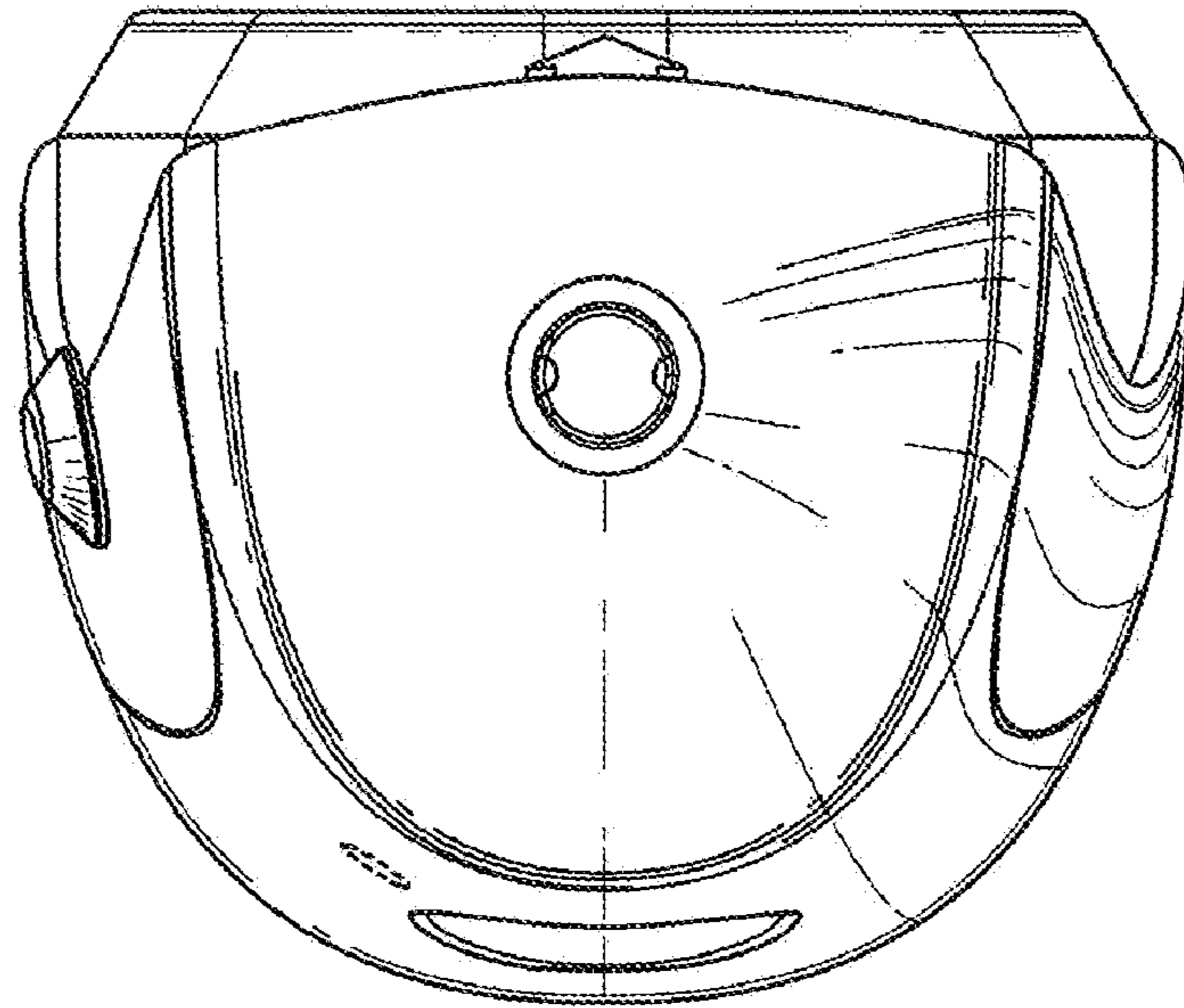

Fig.6

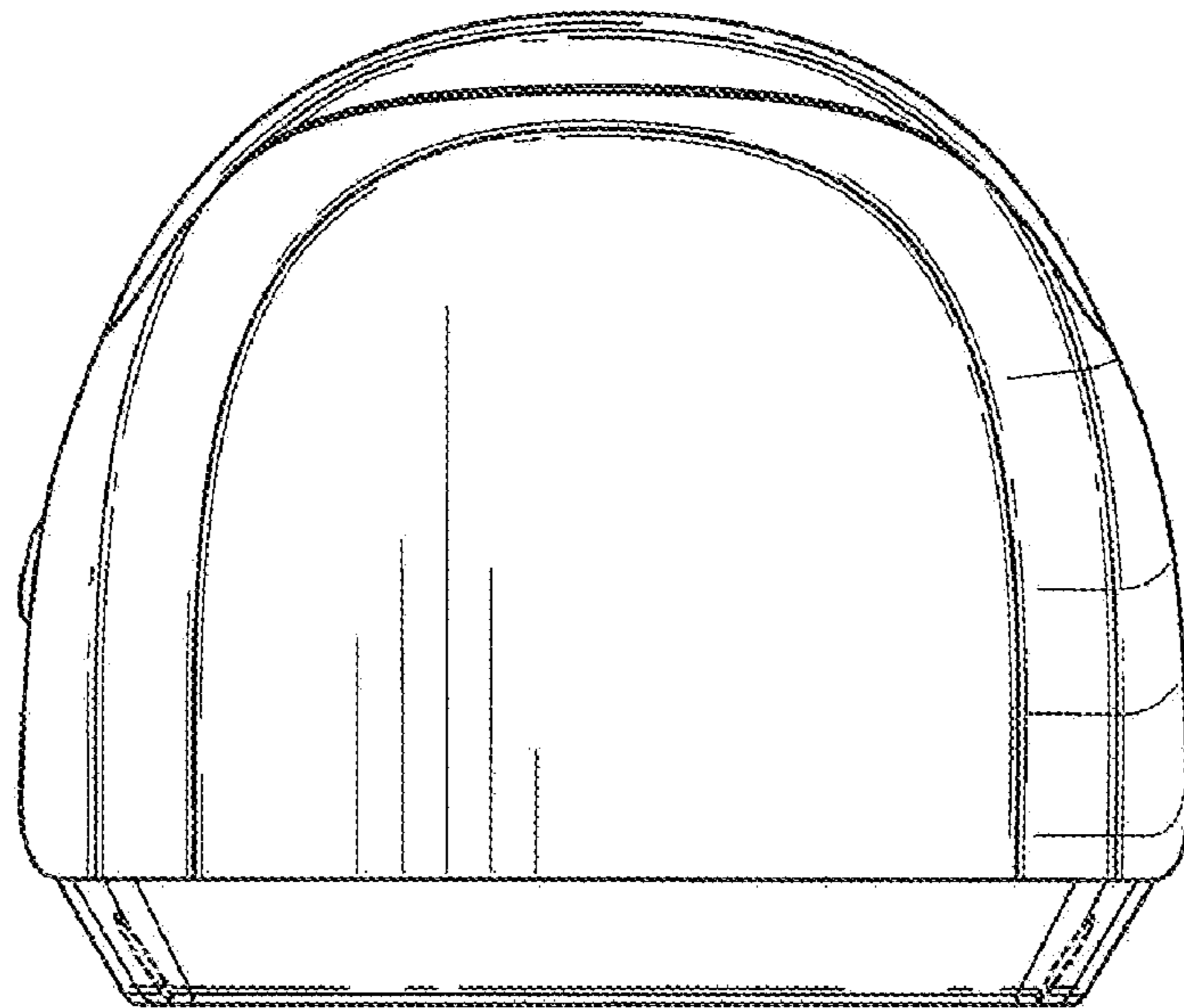

Fig.7

UNITED STATES PATENT AND TRADEMARK OFFICE
CERTIFICATE OF CORRECTION

PATENT NO. : D632,377 S
APPLICATION NO. : 29/359232
DATED : February 8, 2011
INVENTOR(S) : Marcus Blachford et al.

Page 1 of 1

It is certified that error appears in the above-identified patent and that said Letters Patent is hereby corrected as shown below:

Title Pg, Item (73) Assignee:

“Reckitt & Colman (Overseas) Limitd”

Should read:

-- Reckitt & Colman (Overseas) Limited--

Signed and Sealed this
Third Day of May, 2011

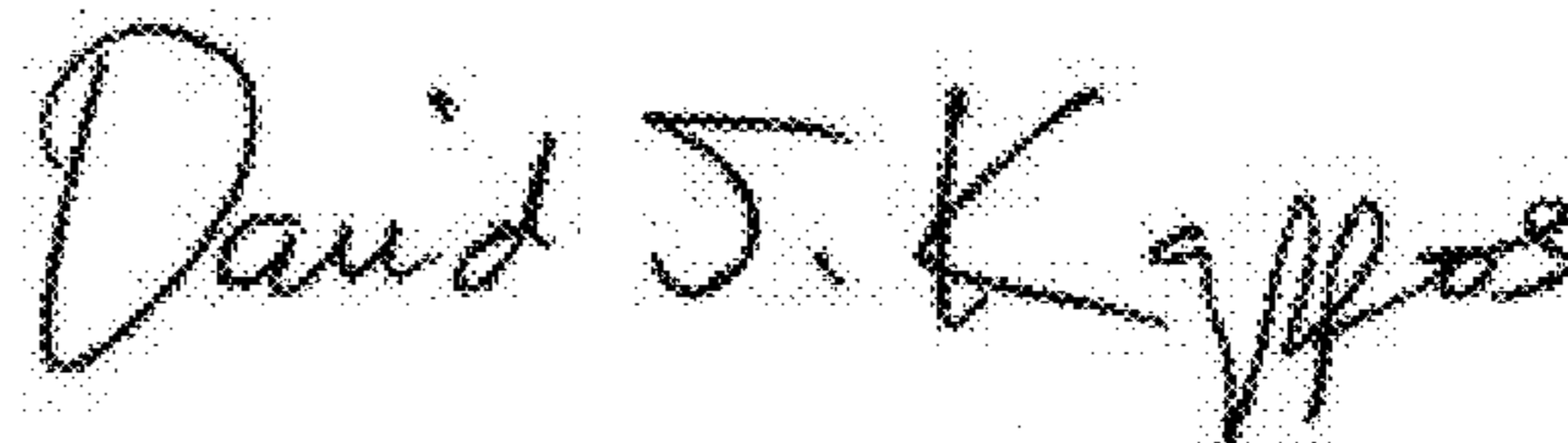
A handwritten signature in black ink that reads "David J. Kappos". The signature is written in a cursive, slightly slanted style.

David J. Kappos
Director of the United States Patent and Trademark Office