



US00D632351S

(12) **United States Design Patent**
Scott et al.

(10) **Patent No.:** **US D632,351 S**
(45) **Date of Patent:** **** Feb. 8, 2011**

(54) **GOLF BALL MARKER AND LEVEL**

(76) Inventors: **John Scott**, 705 Mosaic Cir., Oceanside, CA (US) 92057; **Mark Doherty**, 3310 Cheyenne Ave., San Diego, CA (US) 92117

(**) Term: **14 Years**

(21) Appl. No.: **29/354,817**

(22) Filed: **Jan. 29, 2010**

(51) **LOC (9) Cl.** **21-02**

(52) **U.S. Cl.** **D21/794**

(58) **Field of Classification Search** D21/789,
D21/793, 794; D10/65, 69; 473/285, 251,
473/241, 404, 406, 282; 33/324, 398, 390,
33/365, 373, 377, 384

See application file for complete search history.

(56) **References Cited**

U.S. PATENT DOCUMENTS

D249,657 S * 9/1978 Griffiths D10/69

(Continued)

Primary Examiner—Mitchell I Siegel

(74) *Attorney, Agent, or Firm*—Eleanor M Musick; Procopio, Cory, Hargreaves & Savitch, LLP

(57) **CLAIM**

The ornamental design of a golf ball marker and level, as shown.

DESCRIPTION

FIG. 1 is a side perspective view of the golf ball marker and level showing our new design;

FIG. 2 is a front view of the golf ball marker and level as shown in FIG. 1;

FIG. 3 is rear view of the golf ball marker and level as shown in FIG. 1;

FIG. 4 is a left side view of the golf ball marker and level as shown in FIG. 1;

FIG. 5 is a right side view of the golf ball marker and level as shown in FIG. 1;

FIG. 6 is a top view of the golf ball marker and level as shown in FIG. 1;

FIG. 7 is a bottom view of the golf ball marker and level as shown in FIG. 1;

FIG. 8 is a side perspective view of the golf ball marker and level that shows a second embodiment of FIG. 1, the only difference being the addition of an elongated recess in the golf ball marker and level top surface, it being understood that all other surfaces not shown in FIGS. 8-13 are the same as those of the first embodiment;

FIG. 9 is a front view of the golf ball marker and level as shown in FIG. 8;

FIG. 10 is a left side view of the golf ball marker and level as shown in FIG. 8;

FIG. 11 is a right side view of the golf ball marker and level as shown in FIG. 8;

FIG. 12 is a top view of the golf ball marker and level as shown in FIG. 8;

FIG. 13 is a bottom view of the golf ball marker and level as shown in FIG. 8;

FIG. 14 is a side perspective view of the golf ball marker and level that shows a third embodiment of FIG. 1, the only difference being the addition of an elongated recess that contains the word "Levelhead" and a logo in the golf ball marker and level top surface, it being understood that all other surfaces not shown in FIGS. 14-19 are the same as those of the first embodiment;

FIG. 15 is a front view of the golf ball marker and level as shown in FIG. 14;

FIG. 16 is a left side view of the golf ball marker and level as shown in FIG. 14;

FIG. 17 is a right side view of the golf ball marker and level as shown in FIG. 14;

FIG. 18 is a top view of the golf ball marker and level as shown in FIG. 14; and,

FIG. 19 is a bottom view of the marker as shown in FIG. 14.

1 Claim, 10 Drawing Sheets

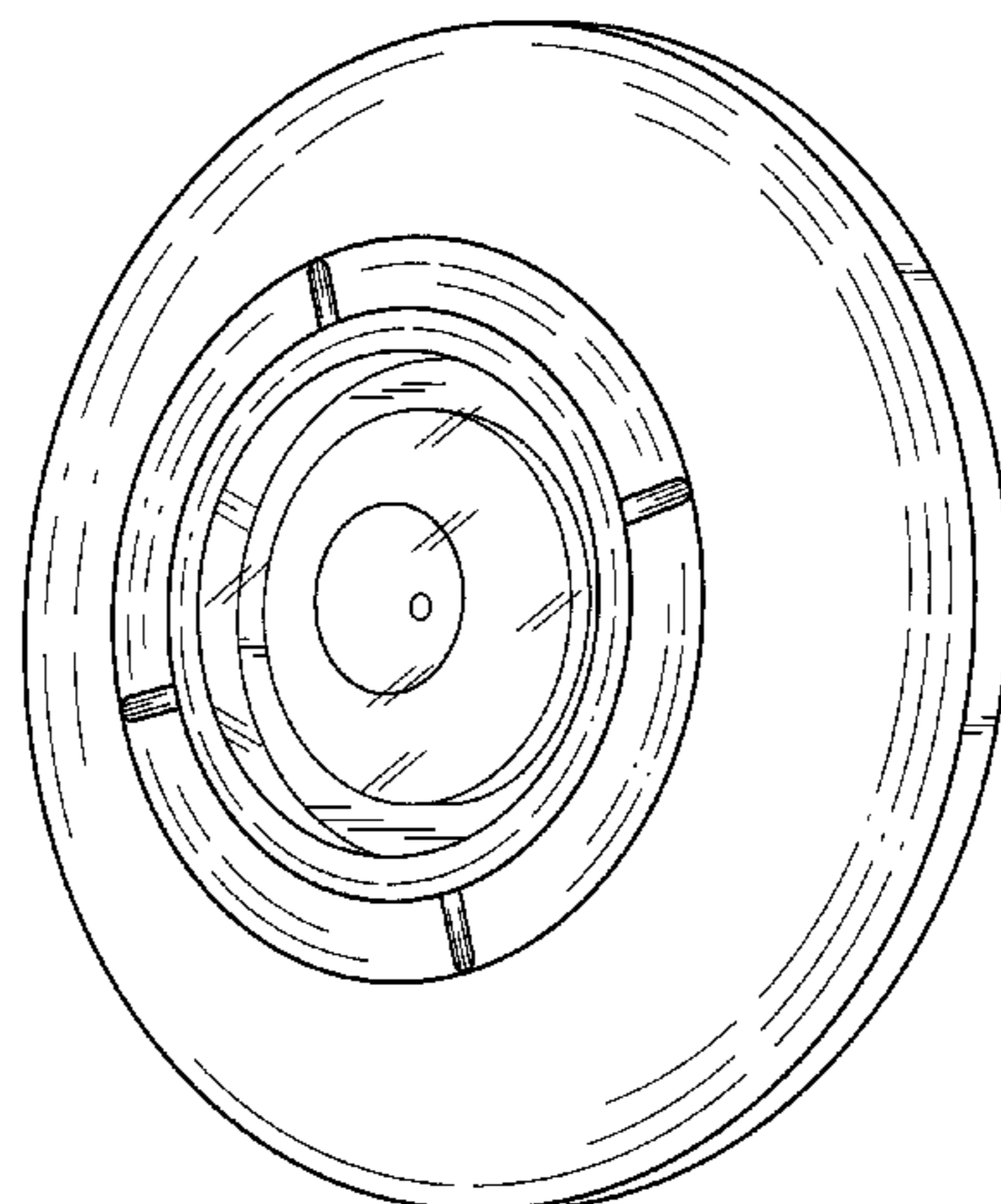

US D632,351 S

Page 2

U.S. PATENT DOCUMENTS

4,822,052	A *	4/1989	Dimmick et al.	473/285	D444,529	S *	7/2001	Wagner	D21/789
4,824,114	A *	4/1989	Catalano	473/251	D517,149	S *	3/2006	Shutter et al.	D21/794
5,157,842	A *	10/1992	Swanda	33/365	D560,739	S *	1/2008	Bernatz et al.	D21/794
5,174,572	A *	12/1992	Ho	473/241	D582,498	S *	12/2008	Austin	D21/791
5,476,258	A *	12/1995	Frisone	473/404	D609,123	S *	2/2010	Pace	D10/65
6,095,933	A *	8/2000	Smith	473/404	2002/0115506	A1 *	8/2002	Kim	473/406

* cited by examiner

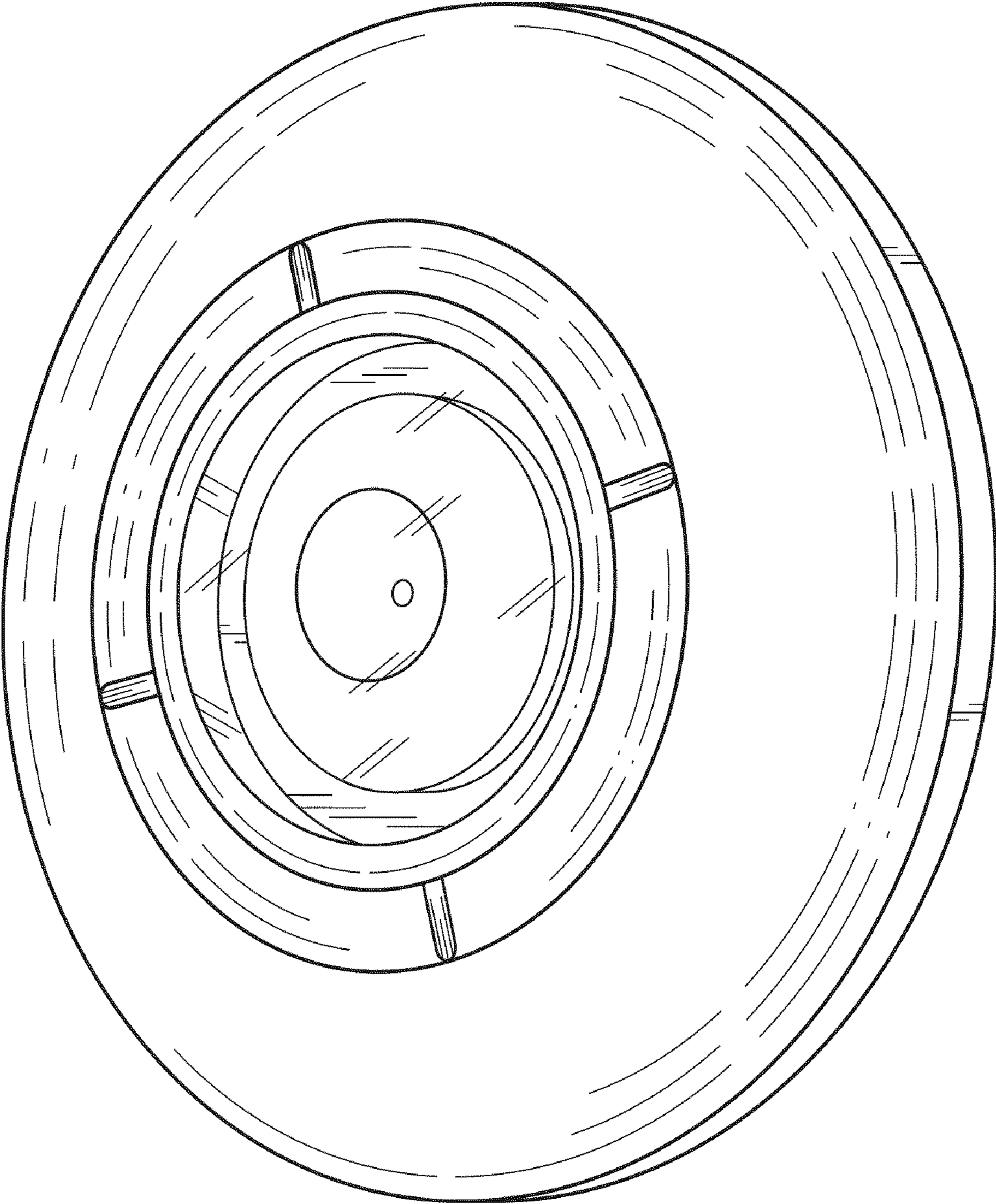

FIG. 1

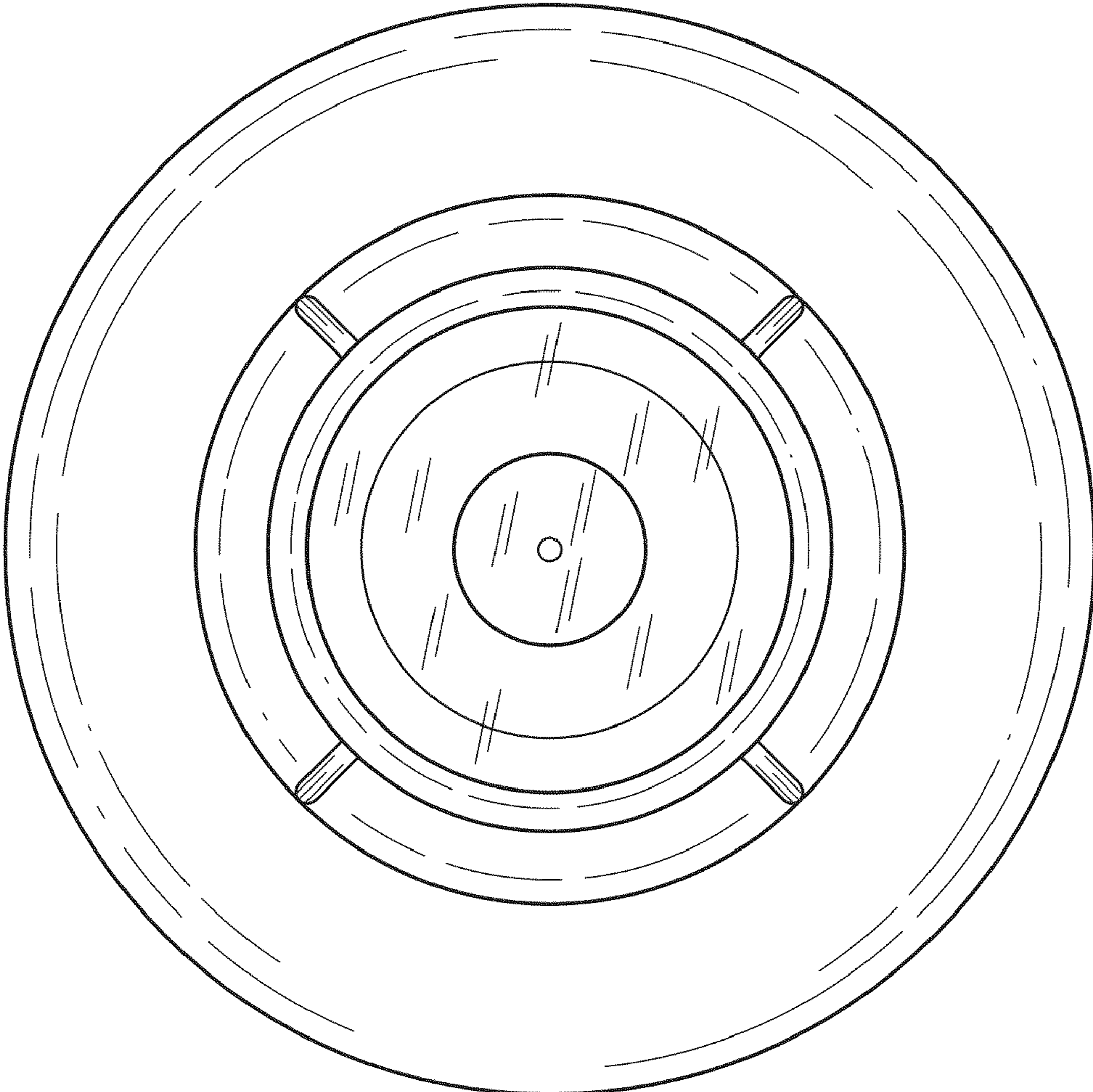

FIG. 2

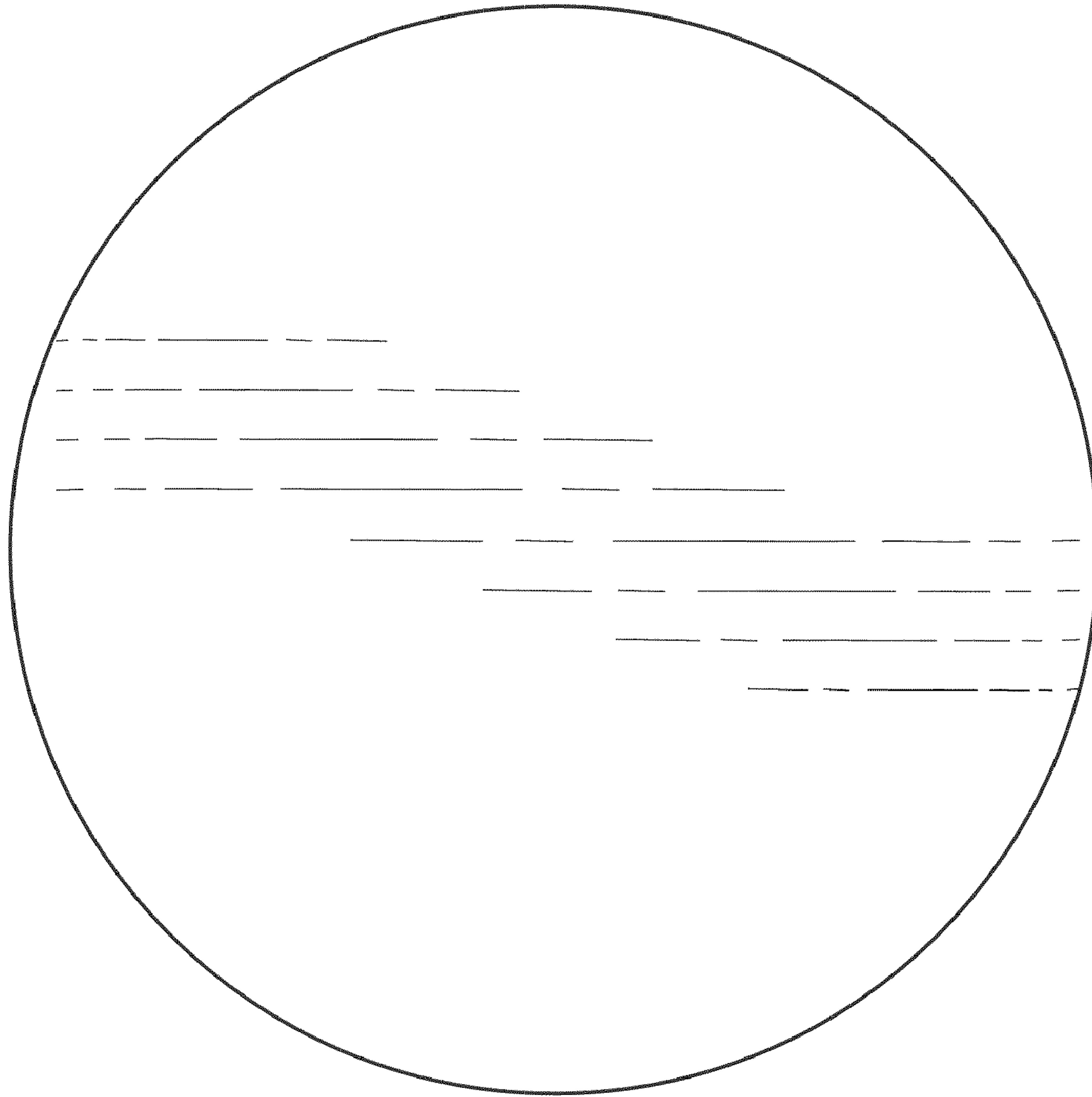

FIG. 3

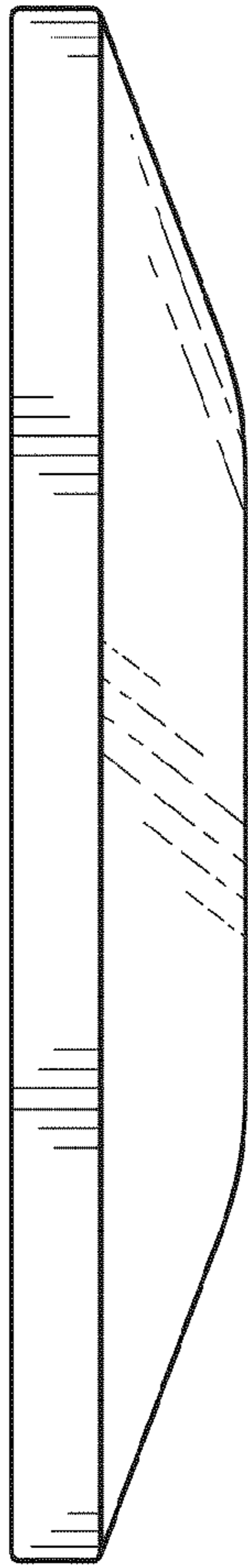

FIG. 4

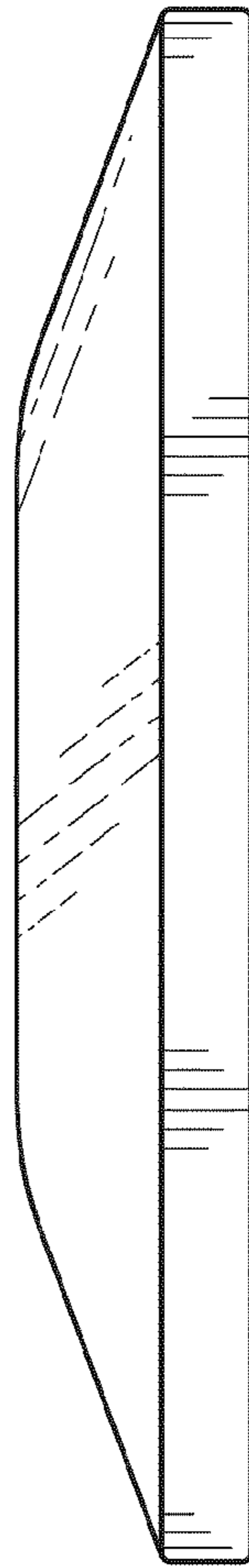

FIG. 5

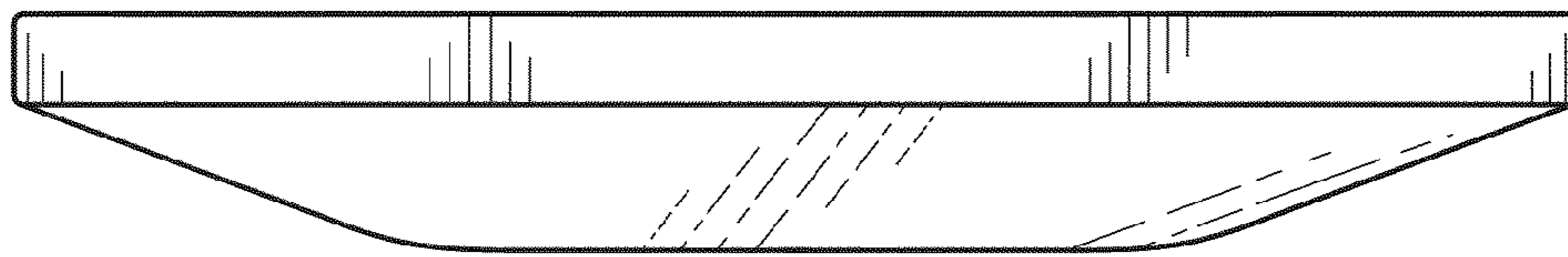

FIG. 6

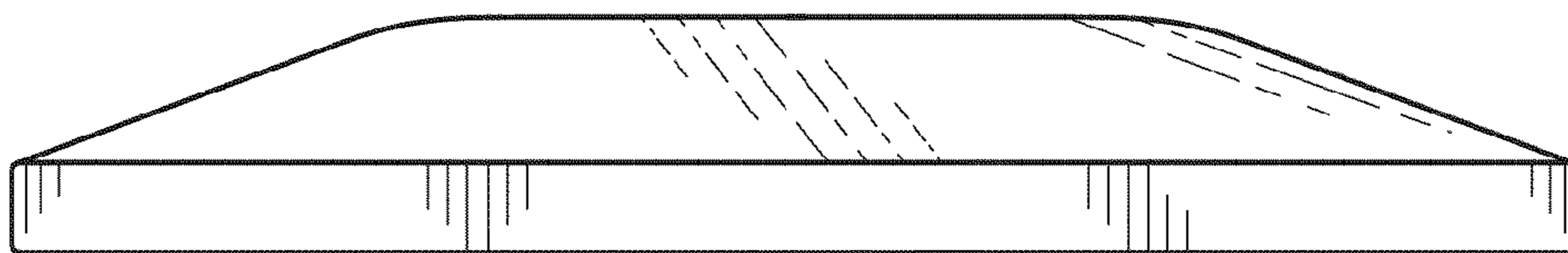

FIG. 7

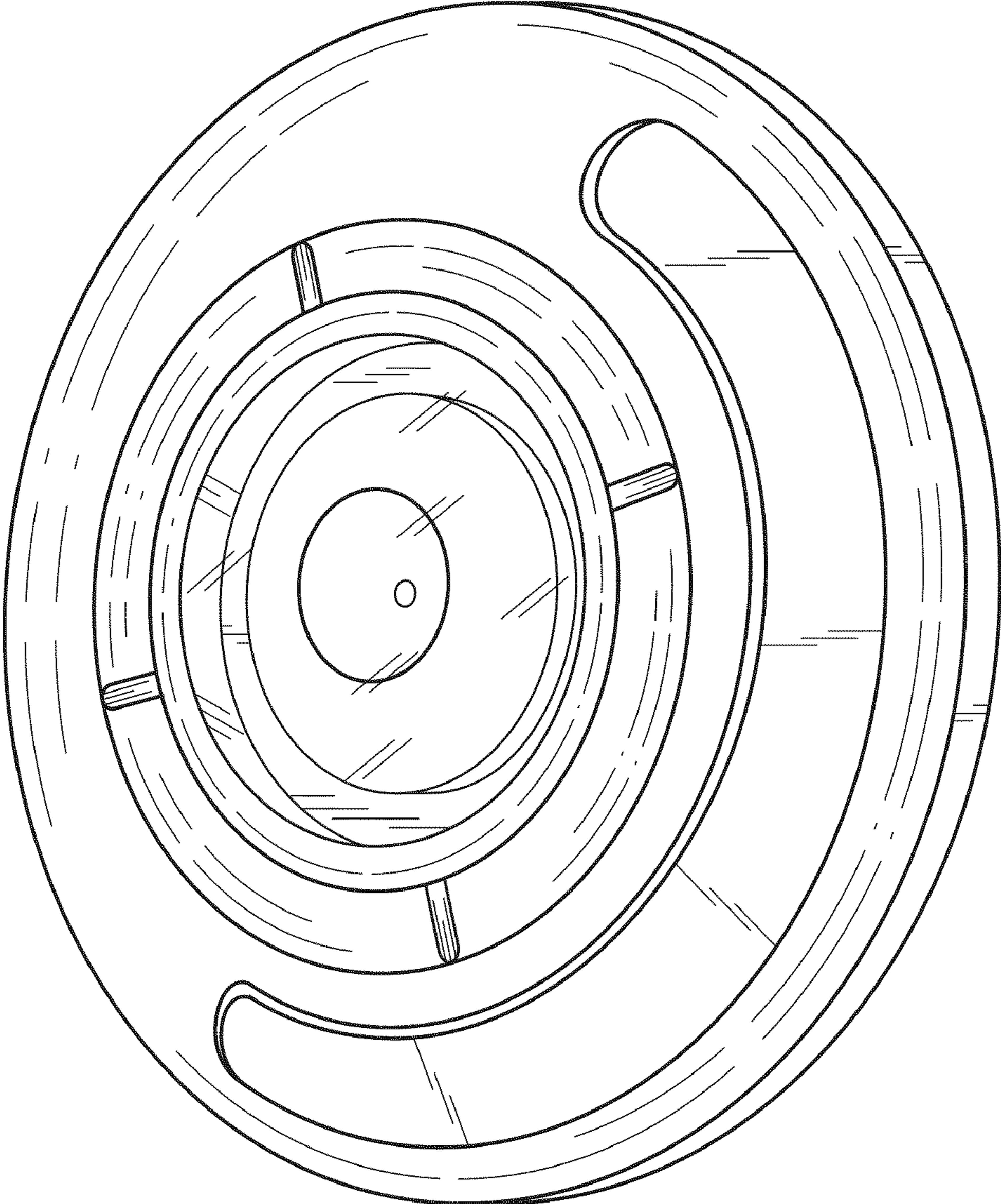

FIG. 8

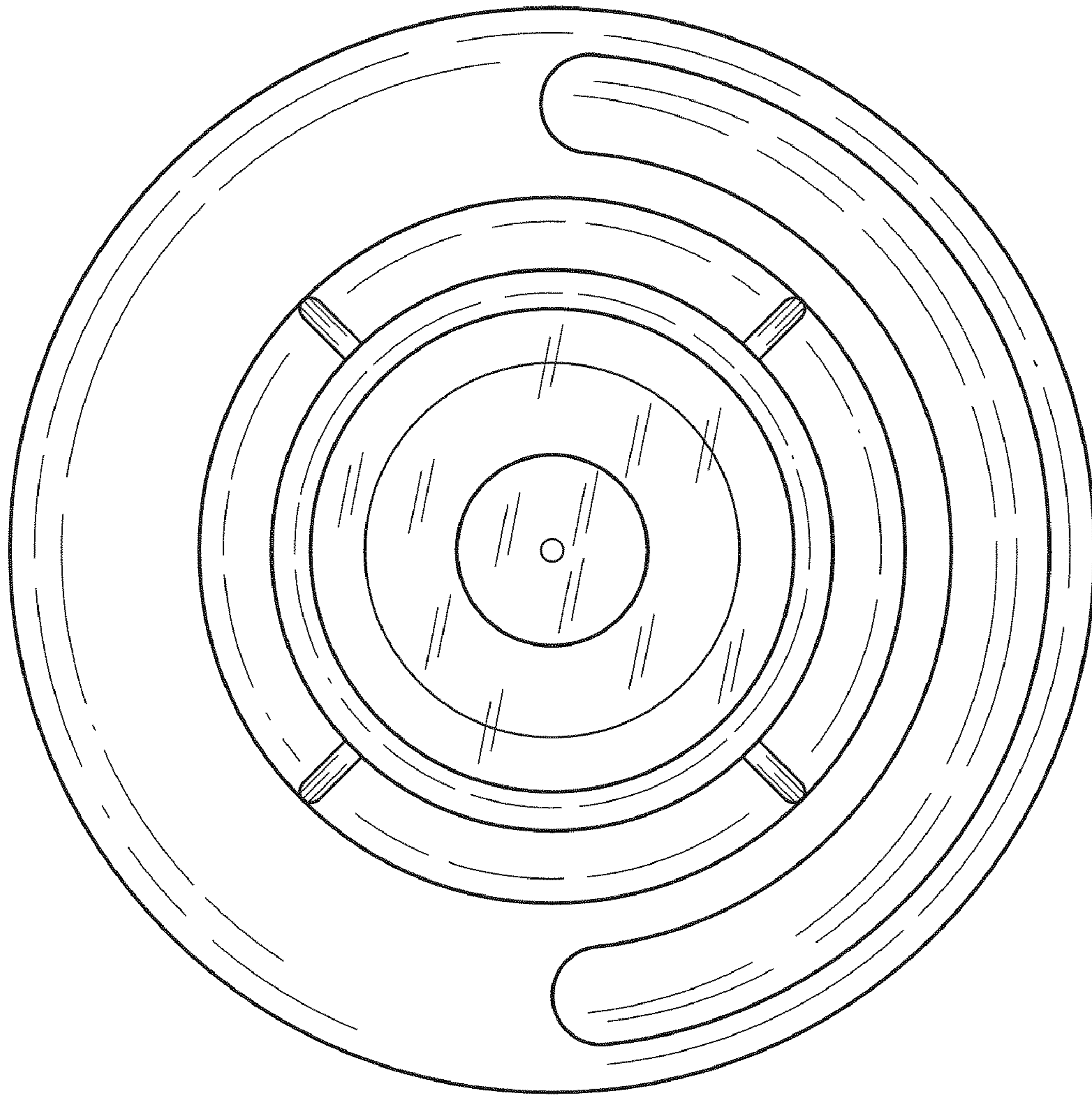

FIG. 9

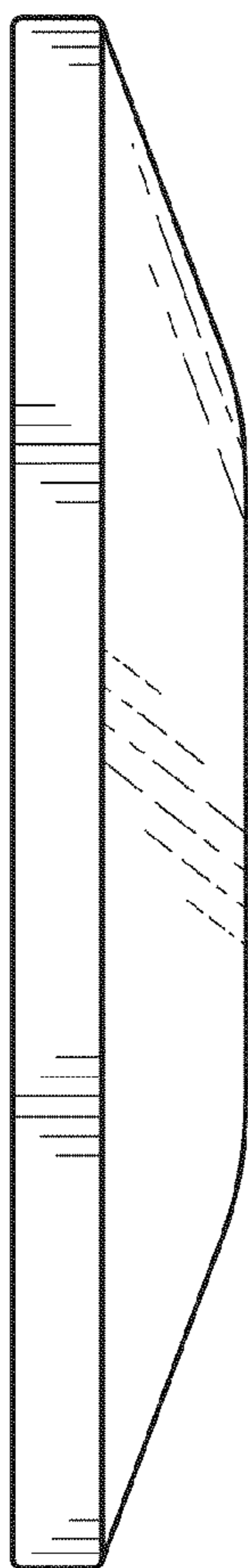

FIG. 10

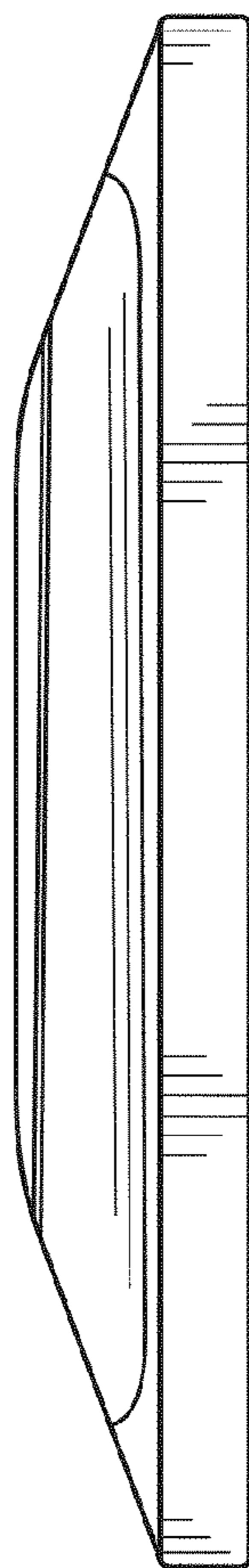

FIG. 11

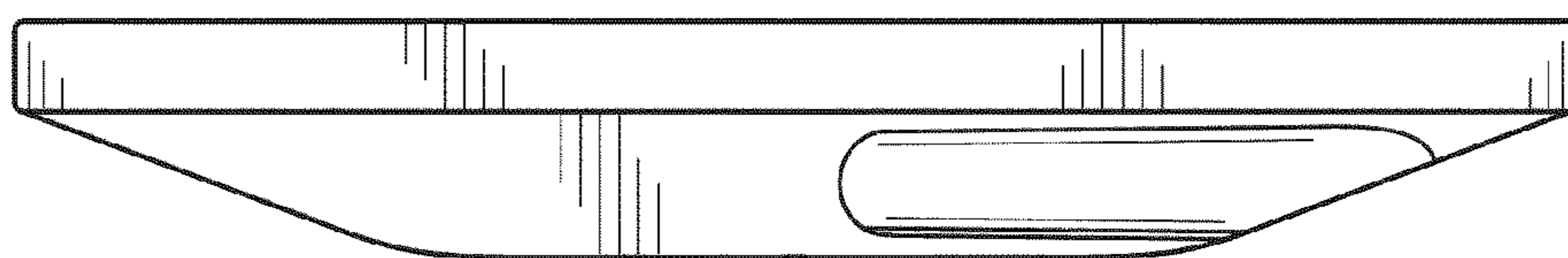

FIG. 12

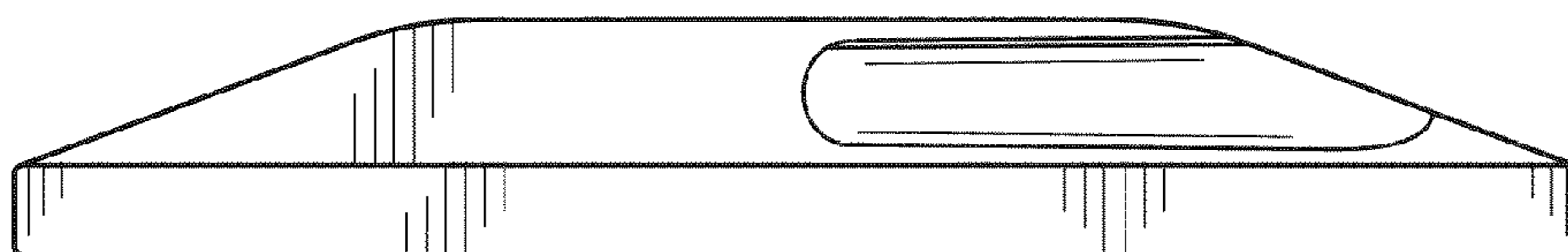

FIG. 13

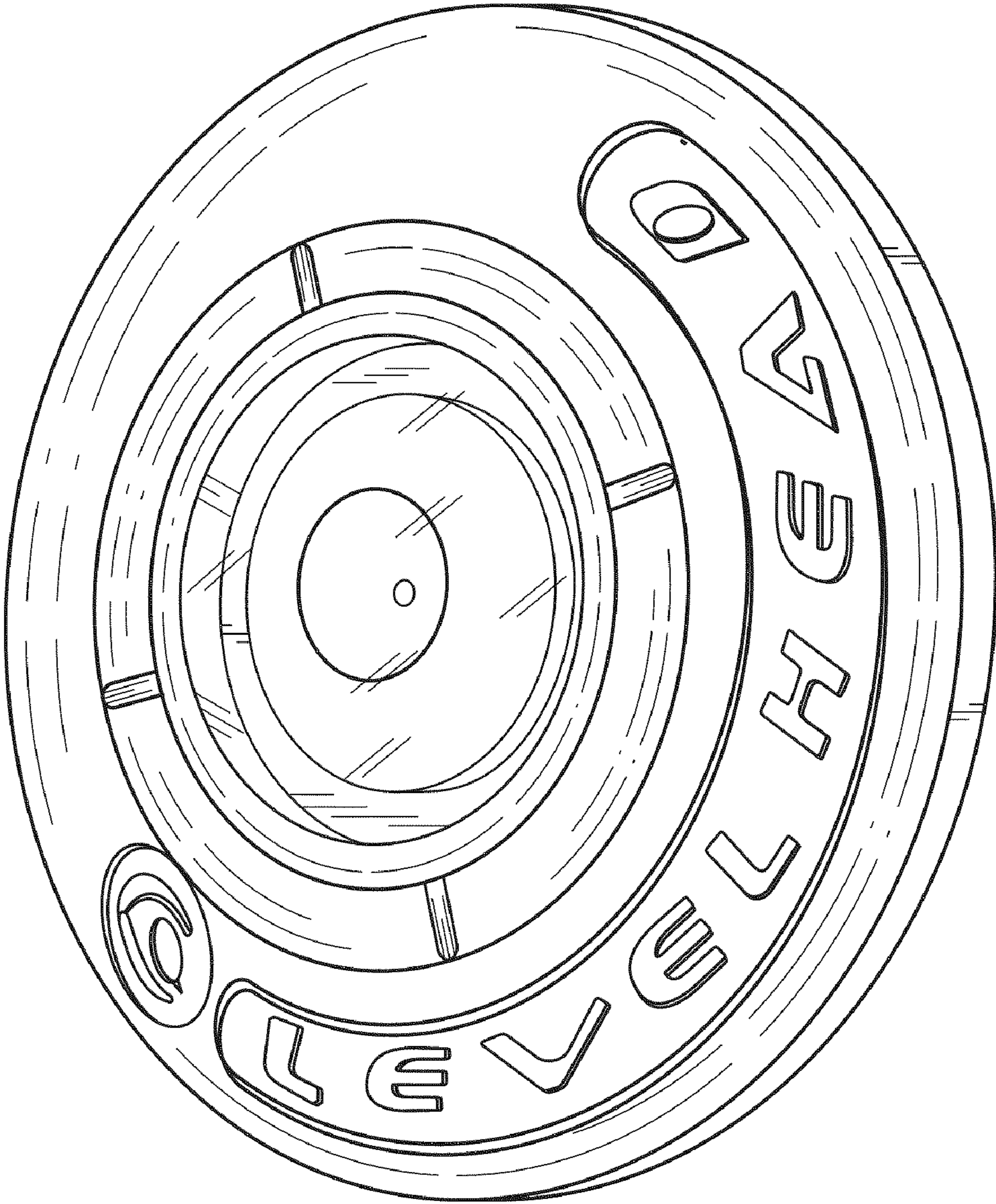

FIG. 14

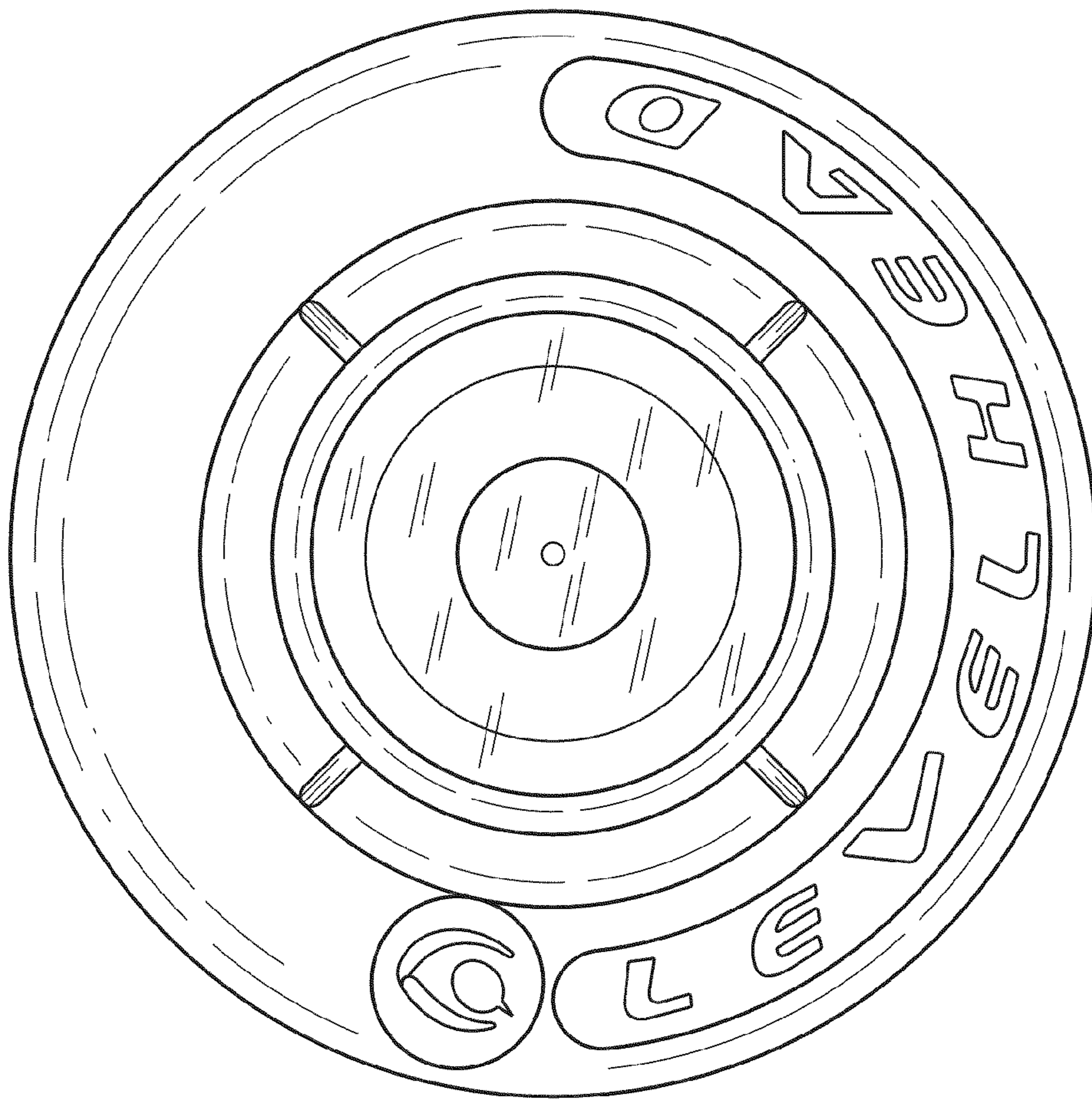

FIG. 15

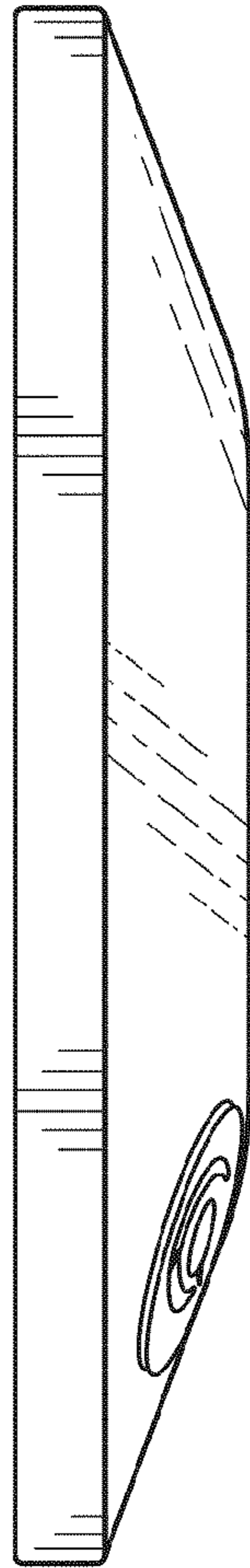

FIG. 16

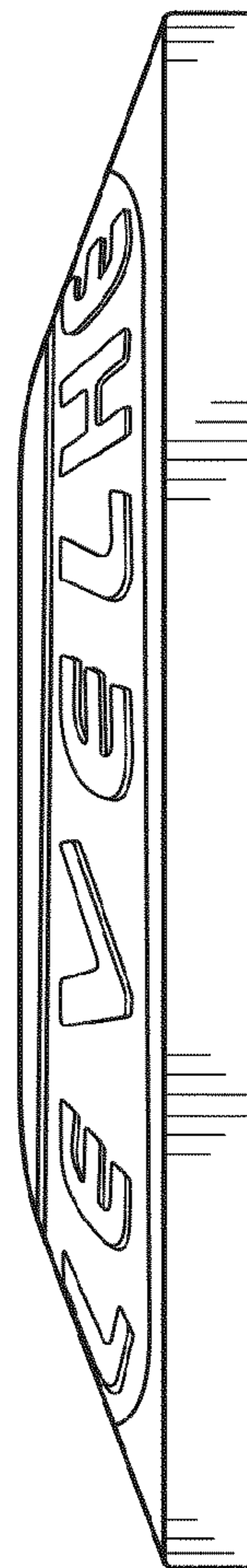

FIG. 17

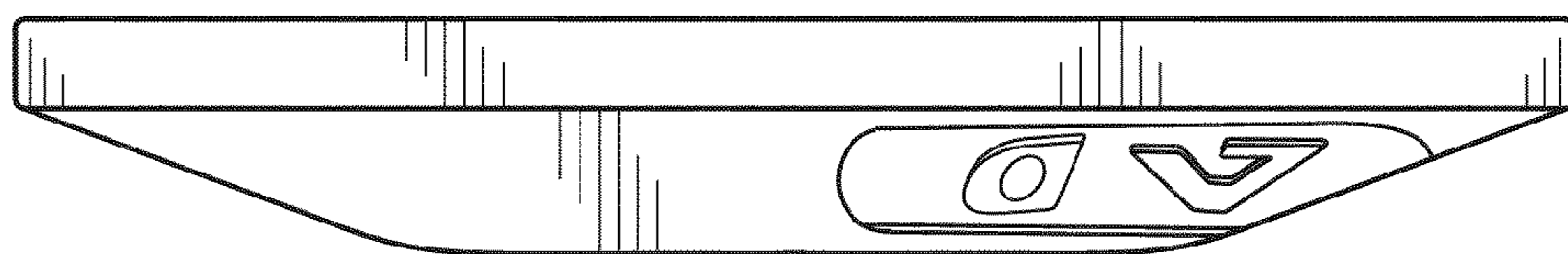

FIG. 18

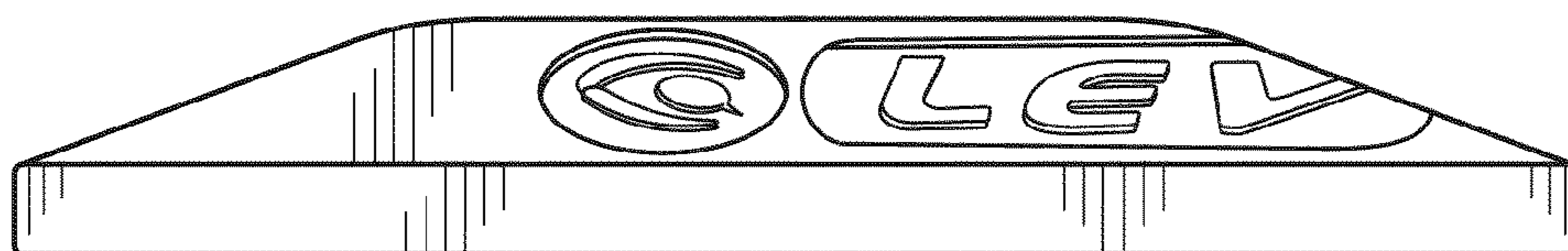

FIG. 19