

US00D632313S

(12) **United States Design Patent**
Kelley

(10) **Patent No.:** **US D632,313 S**

(45) **Date of Patent:** **** *Feb. 8, 2011**

- (54) **PORTION OF A WHEEL LOADER**
- (75) Inventor: **Craig Kelley**, Dunlap, IL (US)
- (73) Assignee: **Caterpillar Inc**, Peoria, IL (US)
- (*) Notice: This patent is subject to a terminal disclaimer.
- (**) Term: **14 Years**
- (21) Appl. No.: **29/355,496**
- (22) Filed: **Feb. 9, 2010**
- (51) **LOC (9) Cl.** **15-03**
- (52) **U.S. Cl.** **D15/33; D15/30; D15/31**
- (58) **Field of Classification Search** D15/24–26,
D15/22–23, 31, 33, 32, 30; 37/455, 442,
37/443; 414/685, 694, 722, 724; 180/89.1,
180/89.12, 298, 900, 68.5
See application file for complete search history.

D500,056	S *	12/2004	DeYoung et al.	D15/33
6,854,523	B2 *	2/2005	Takahashi	172/3
D549,738	S *	8/2007	Hiraoka et al.	D15/25
D590,846	S *	4/2009	Kinsinger et al.	D15/25
D593,582	S *	6/2009	Ono et al.	D15/23
D594,035	S *	6/2009	Ono et al.	D15/23
2002/0060081	A1 *	5/2002	McGugan	172/4.5
2003/0221845	A1 *	12/2003	Takahashi	172/3
2004/0149463	A1 *	8/2004	Maeda et al.	172/297
2005/0252669	A1 *	11/2005	LaReau et al.	172/776

OTHER PUBLICATIONS

CAT, 950H Wheel Loader, Catalog, pp. 1-28, 2007, U.S.A.
CAT, 962H Wheel Loader, Catalog, pp. 1-32, 2007, U.S.A.

* cited by examiner

Primary Examiner—Mark A Goodwin

(74) *Attorney, Agent, or Firm*—Jeff A. Ruppel

(57) **CLAIM**

The ornamental design for a portion of a wheel loader, as shown and described.

DESCRIPTION

FIG. 1 is a left side view of a portion of a wheel loader showing my new design;

FIG. 2 is a right side view thereof;

FIG. 3 is a top plan view thereof;

FIG. 4 is a front view thereof;

FIG. 5 is a rear view thereof; and,

FIG. 6 is a left rear perspective view thereof.

The broken lines of the figures showing additional portions of the wheel loader are included for the purpose of illustrating environmental structure and form no part of the claimed design.

1 Claim, 6 Drawing Sheets

(56) **References Cited**
U.S. PATENT DOCUMENTS

D184,216	S *	1/1959	Erlacher et al.	D15/23
D188,840	S *	9/1960	Beyer, Jr. et al.	D15/23
3,527,315	A *	9/1970	Hampton	180/238
3,858,661	A *	1/1975	Hallam et al.	172/1
3,889,976	A *	6/1975	Jesswein	280/400
D238,955	S *	2/1976	Peterson	D21/537
4,213,507	A *	7/1980	Horrer et al.	172/784
D275,107	S *	8/1984	Crabiel et al.	D15/25
4,535,860	A *	8/1985	Waggoner	180/24.05
4,679,634	A *	7/1987	Bulmahn	172/250
4,696,486	A *	9/1987	Ruhter	280/400
D364,408	S *	11/1995	Bryant et al.	D15/25
5,474,147	A *	12/1995	Yesel et al.	180/197
D410,930	S *	6/1999	Kim et al.	D15/25
D412,506	S *	8/1999	Boyer et al.	D15/25
6,230,818	B1 *	5/2001	Slunder	172/789

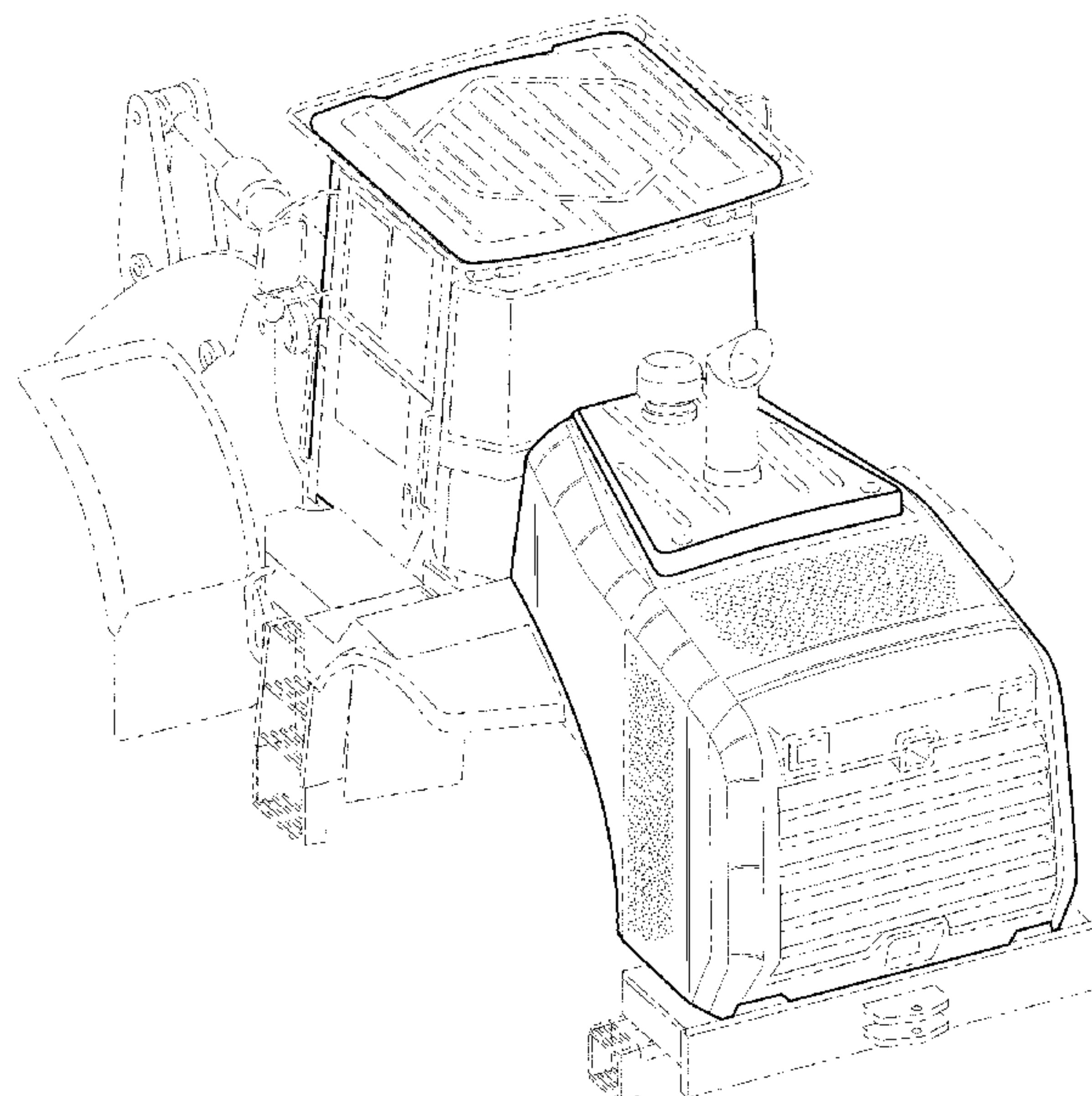
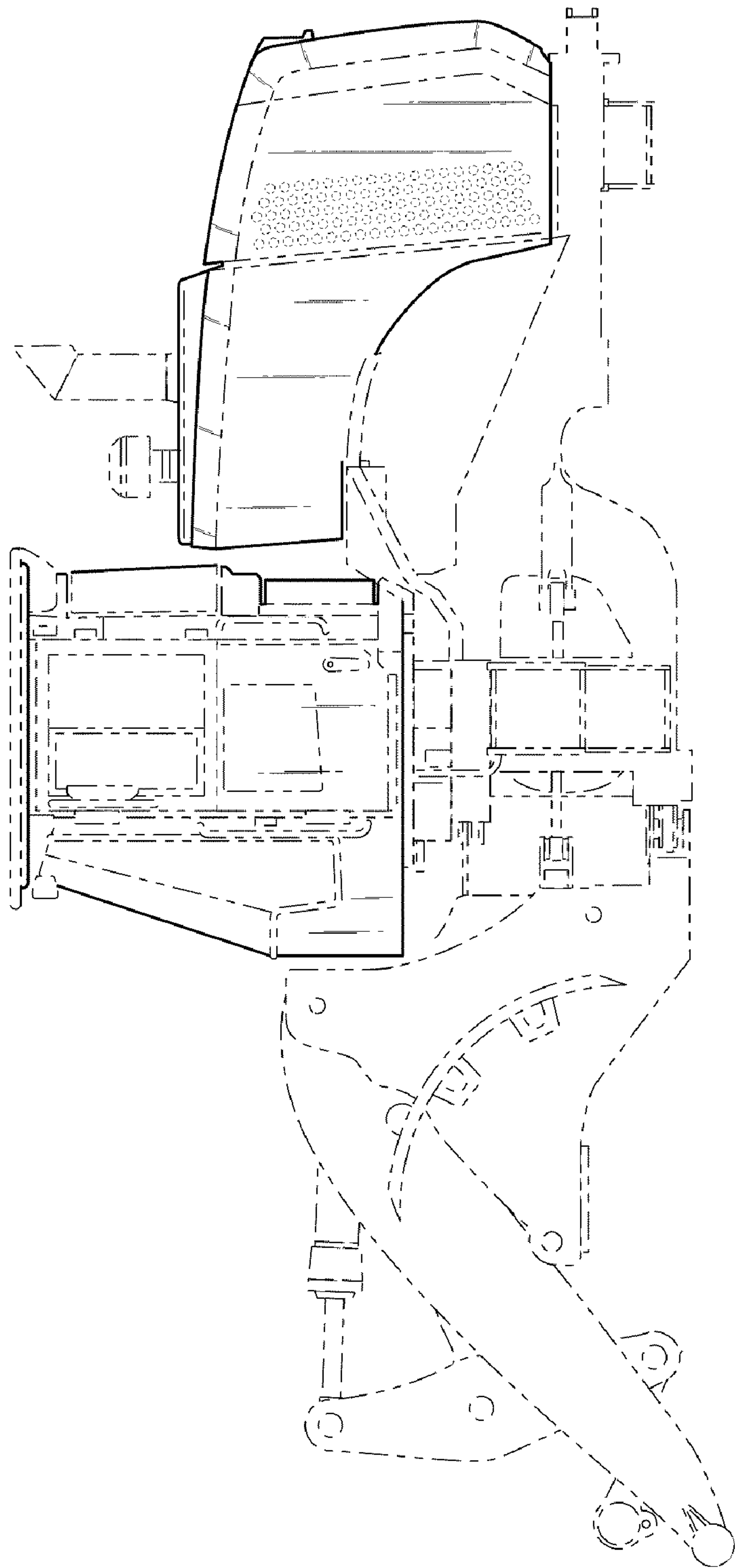

FIG. 1



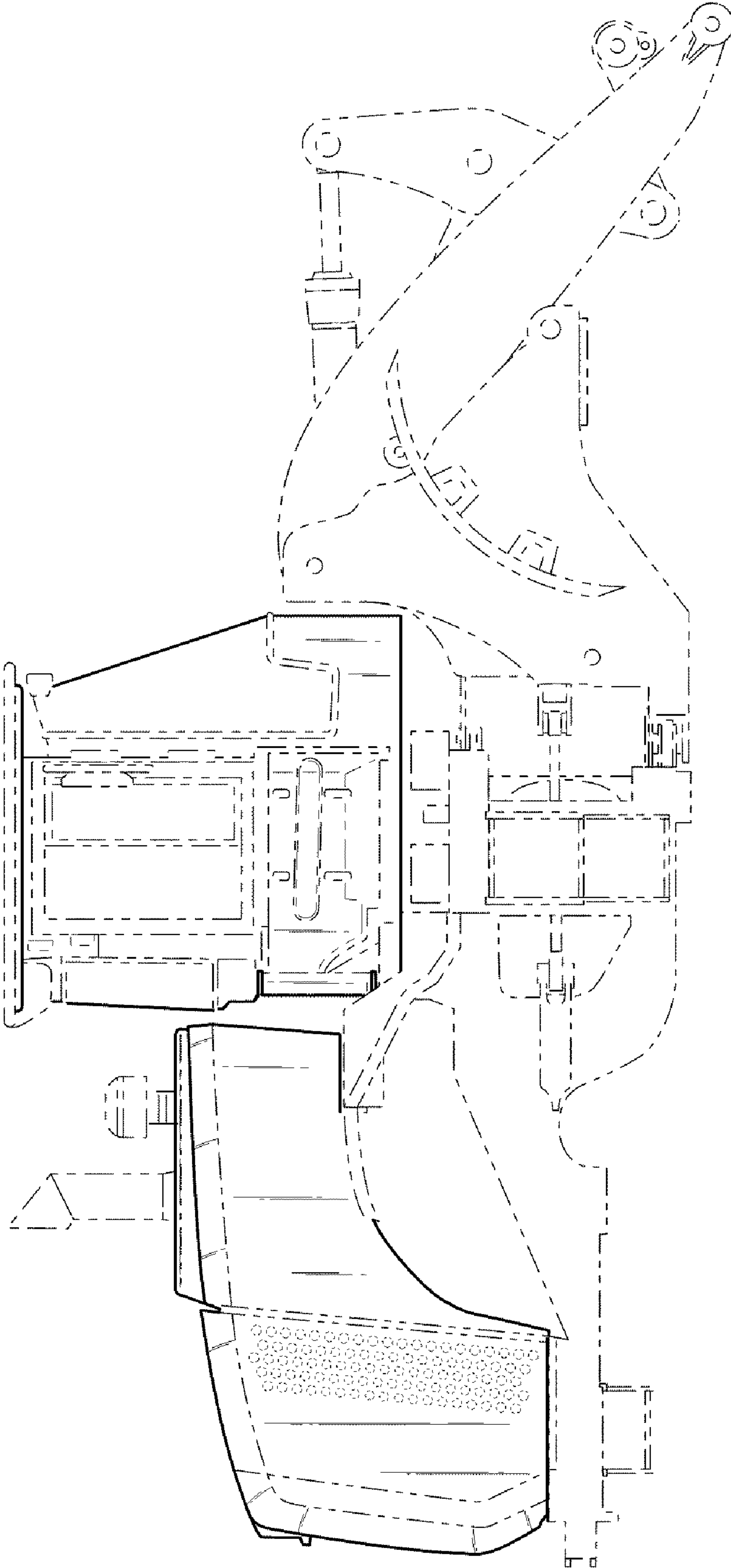

FIG. 2

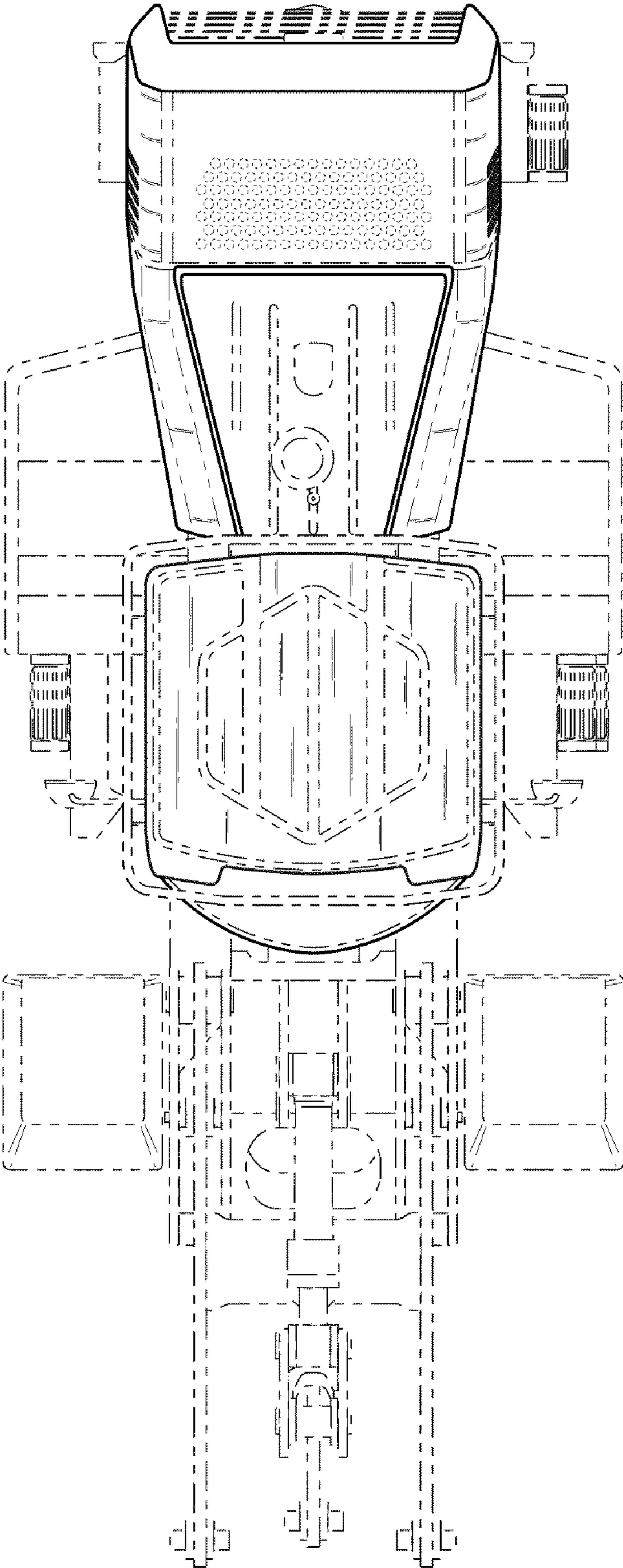

FIG. 3

FIG. 4

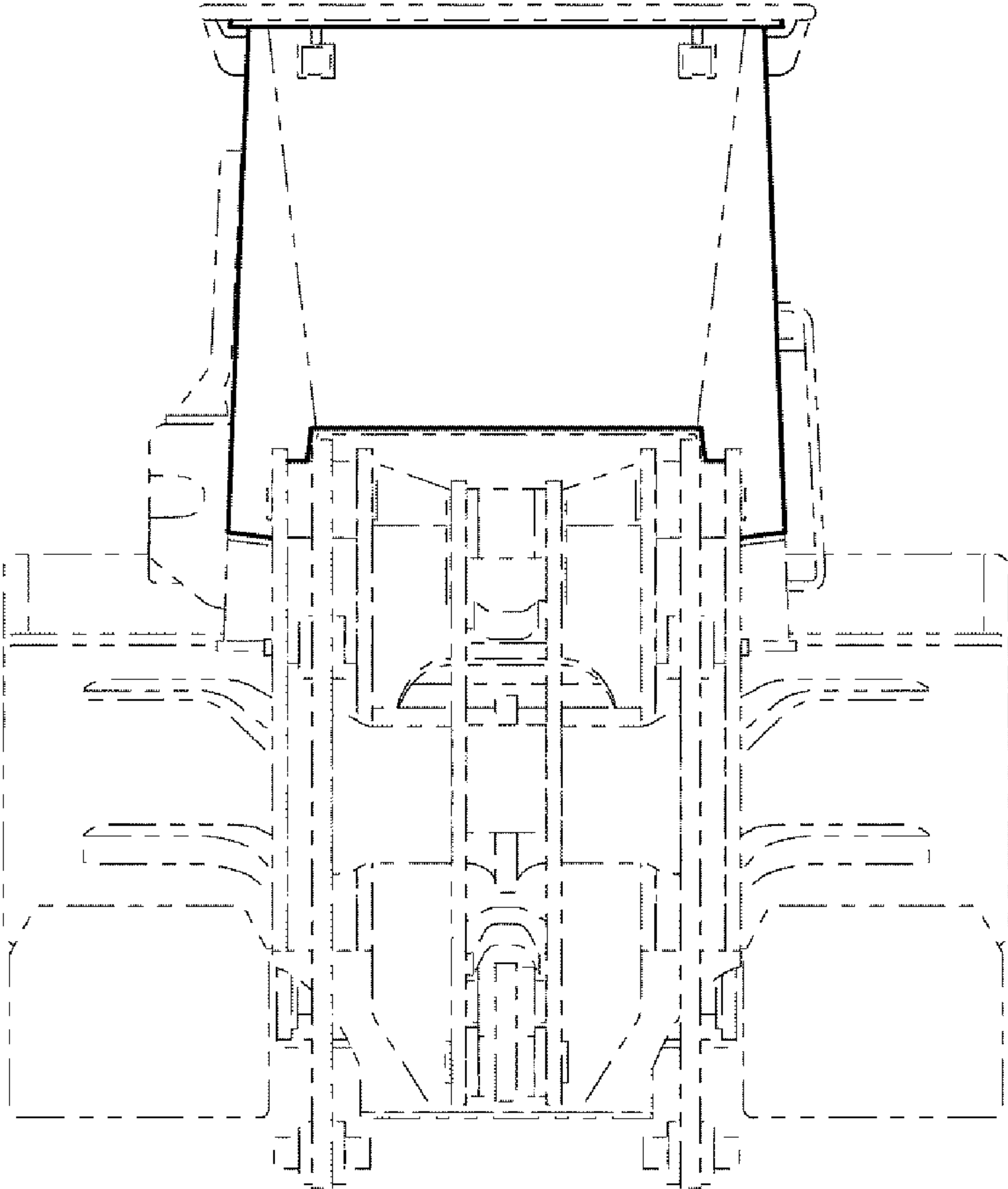
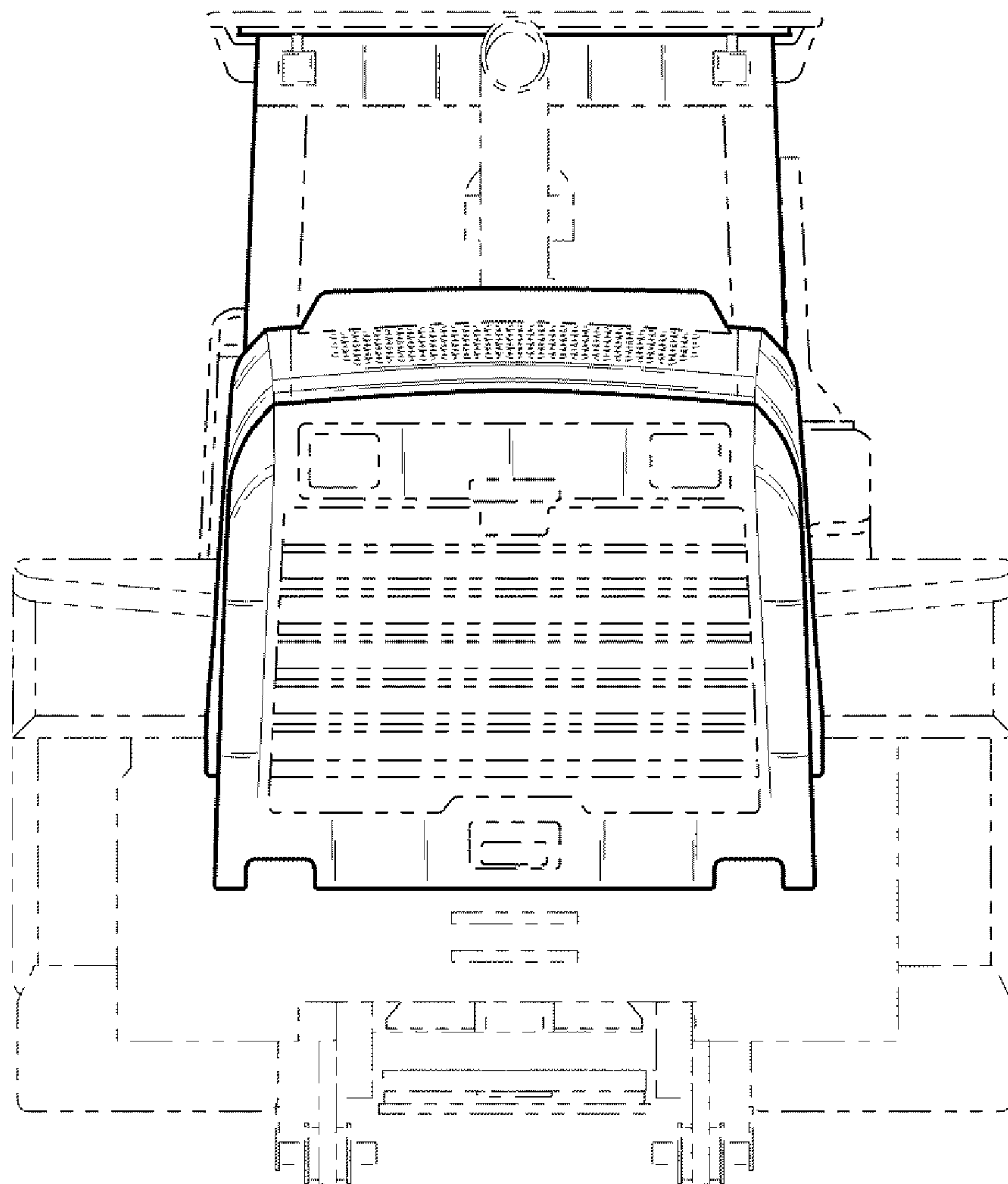

FIG. 5



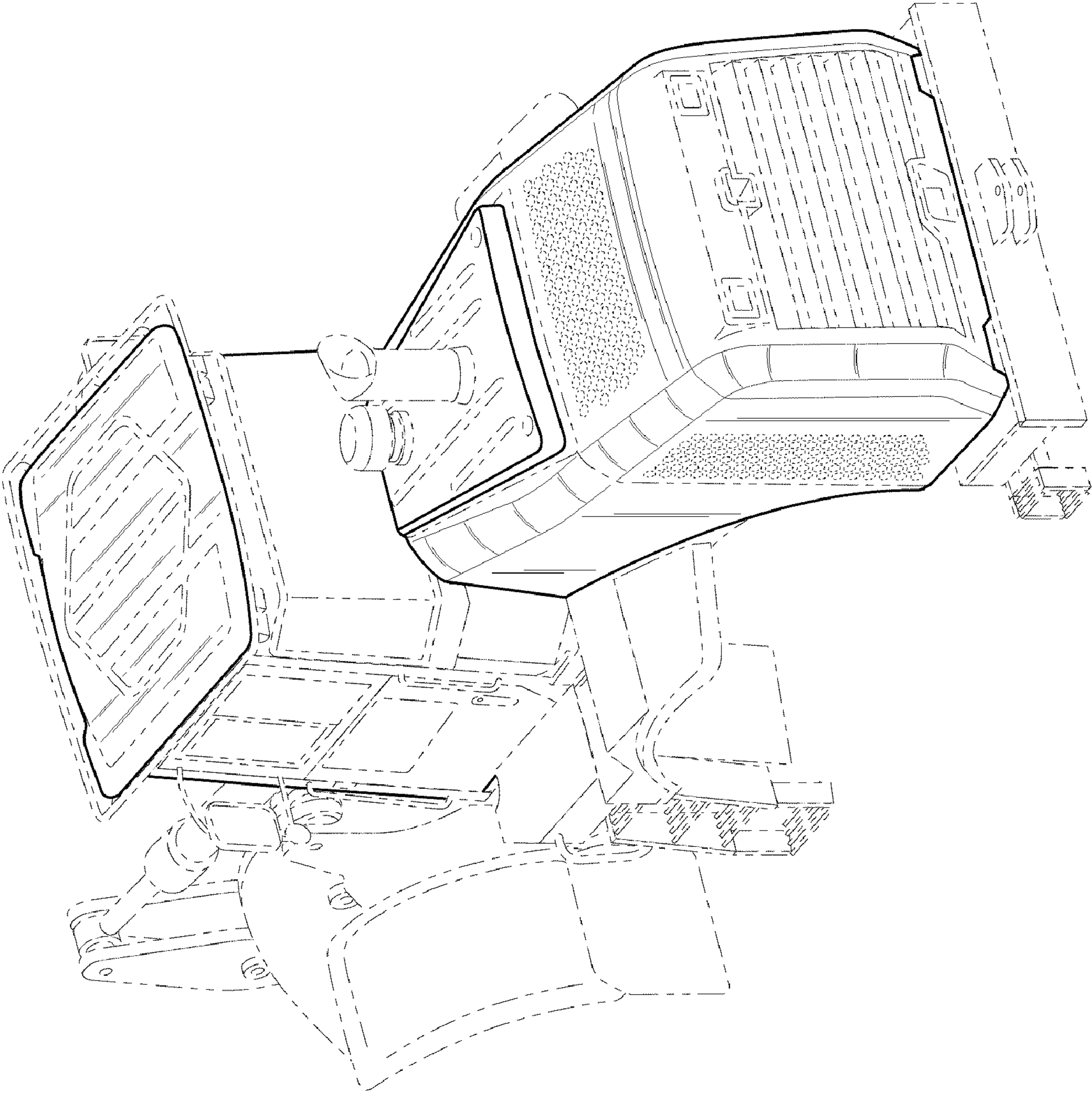

FIG. 6