



US00D632269S

(12) **United States Design Patent**
Garra et al.

(10) **Patent No.:** **US D632,269 S**
(45) **Date of Patent:** **** Feb. 8, 2011**

(54) **COMMUNICATION DEVICE**

(75) Inventors: **Lan Ting L. Garra**, Sunrise, FL (US);
Chi T. Tran, Weston, FL (US)

(73) Assignee: **Motorola, Inc.**, Schaumburg, IL (US)

(**) Term: **14 Years**

(21) Appl. No.: **29/363,108**

(22) Filed: **Jun. 4, 2010**

(51) **LOC (9) Cl.** **14-03**

(52) **U.S. Cl.** **D14/137**

(58) **Field of Classification Search** D14/135,
D14/137, 139, 157, 188, 197-198, 257, 258,
D14/138 R, 138 AA, 138 C, 138, 138 AD,
D14/138 AC, 138 G, 147, 218, 341-347;
361/814; 455/90.1-90.3

See application file for complete search history.

(56) **References Cited**

U.S. PATENT DOCUMENTS

D340,451 S * 10/1993 Beaumont et al. D14/138 AD
D387,758 S * 12/1997 Oross et al. D14/137

(Continued)

OTHER PUBLICATIONS

Motorola CP125, [online], [retrieved on Mar. 24, 2009]. Retrieved from Internet ,<URL: <http://www.talktwoway.com>>.*

Primary Examiner—Jeffrey D Asch

Assistant Examiner—Bridget L Eland

(74) *Attorney, Agent, or Firm*—Barbara R. Doutre; Anthony P. Curtis

(57) **CLAIM**

The ornamental design for a communication device, as shown and described.

DESCRIPTION

FIG. 1 is a front perspective view of a first embodiment of an ornamental design for a communication device;

FIG. 2 is a rear perspective view of the first embodiment thereof;

FIG. 3 is a front view of the first embodiment thereof;

FIG. 4 is a rear view of the first embodiment thereof;

FIG. 5 is a first side view of the first embodiment thereof;

FIG. 6 is a second side view of the first embodiment thereof;

FIG. 7 is a top view of the first embodiment thereof; and

FIG. 8 is a bottom view of the first embodiment thereof.

FIG. 9 is a front perspective view of a second embodiment of an ornamental design for a communication device;

FIG. 10 is a rear perspective view of the second embodiment thereof;

FIG. 11 is a front view of the second embodiment thereof;

FIG. 12 is a rear view of the second embodiment thereof;

FIG. 13 is a first side view of the second embodiment thereof;

FIG. 14 is a second side view of the second embodiment thereof;

FIG. 15 is a top view of the second embodiment thereof; and,

FIG. 16 is a bottom view of the second embodiment thereof.

The broken lines shown in FIGS. 1-8, that are immediately adjacent to the shaded areas, and define unshaded regions, represent the bounds of the first embodiment, while all other broken lines are directed to environment and are for illustrative purposes only; the broken lines form no part of the first embodiment.

1 Claim, 10 Drawing Sheets

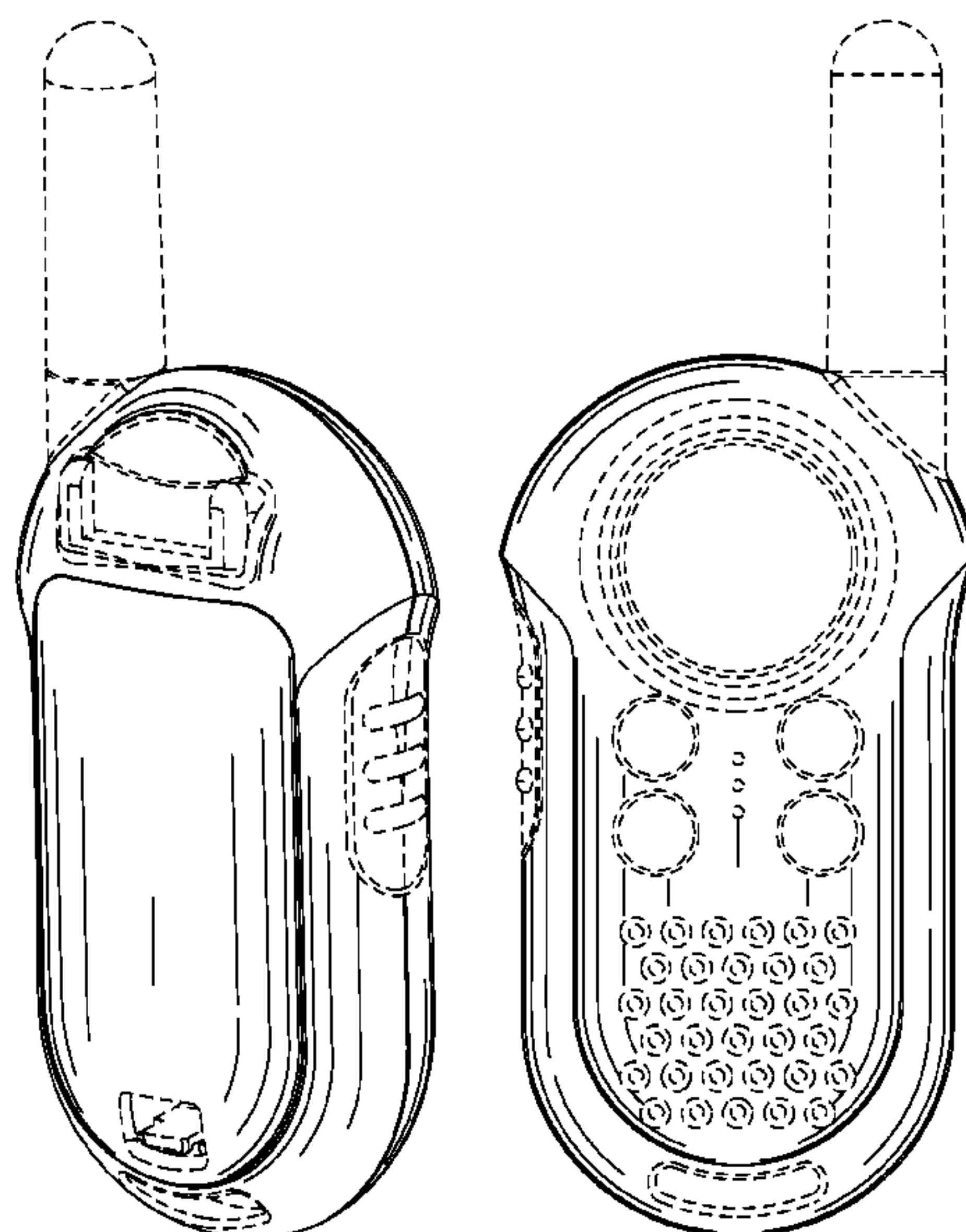

US D632,269 S

Page 2

U.S. PATENT DOCUMENTS

D389,827 S *	1/1998	Oross et al.	D14/137	D493,155 S *	7/2004	Robertson, Jr. et al.	D14/137
D395,882 S *	7/1998	Oross et al.	D14/137	D499,391 S *	12/2004	Robertson, Jr. et al.	D14/147
5,896,277 A *	4/1999	Leon et al.	361/814	D500,486 S *	1/2005	Zeitman	D14/188
6,071,640 A *	6/2000	Robertson et al.	429/100	D510,332 S *	10/2005	Haase et al.	D14/137
D433,001 S *	10/2000	Haase et al.	D14/137	D519,477 S *	4/2006	Liu et al.	D14/137
D433,395 S *	11/2000	Wong	D14/137	D564,997 S *	3/2008	Tran et al.	D14/137
D433,396 S *	11/2000	Wong	D14/137	D564,998 S *	3/2008	Tran et al.	D14/137
6,473,631 B1 *	10/2002	Siddoway et al.	455/575.1	D566,075 S *	4/2008	Leng et al.	D14/137
D467,565 S *	12/2002	Pesqueira et al.	D14/137	D576,127 S *	9/2008	Tran et al.	D14/137
D467,888 S *	12/2002	Mirabelli et al.	D14/137	D576,128 S *	9/2008	Tran et al.	D14/137
D481,025 S *	10/2003	Cebe et al.	D14/137	2004/0051497 A1 *	3/2004	Richards et al.	320/103
				2010/0203849 A1 *	8/2010	Straub	455/90.2

* cited by examiner

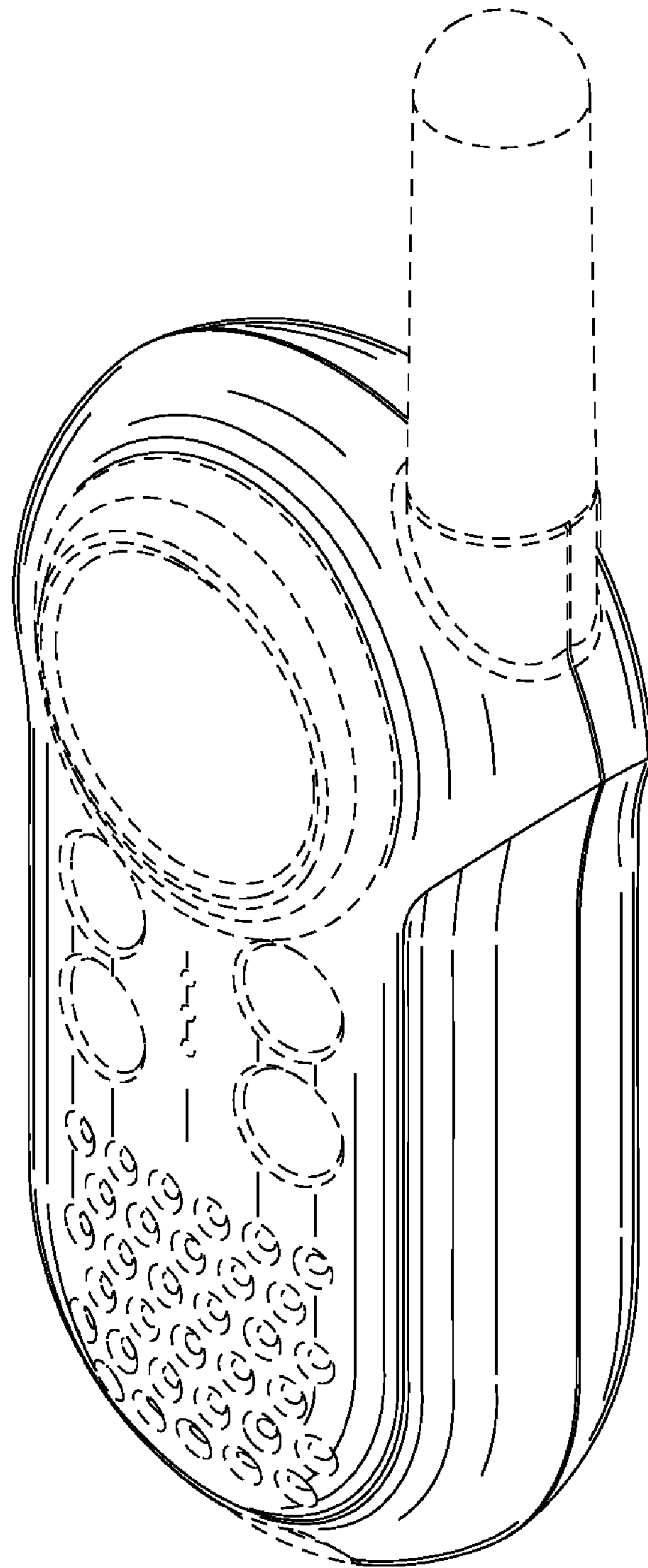

FIG. 1

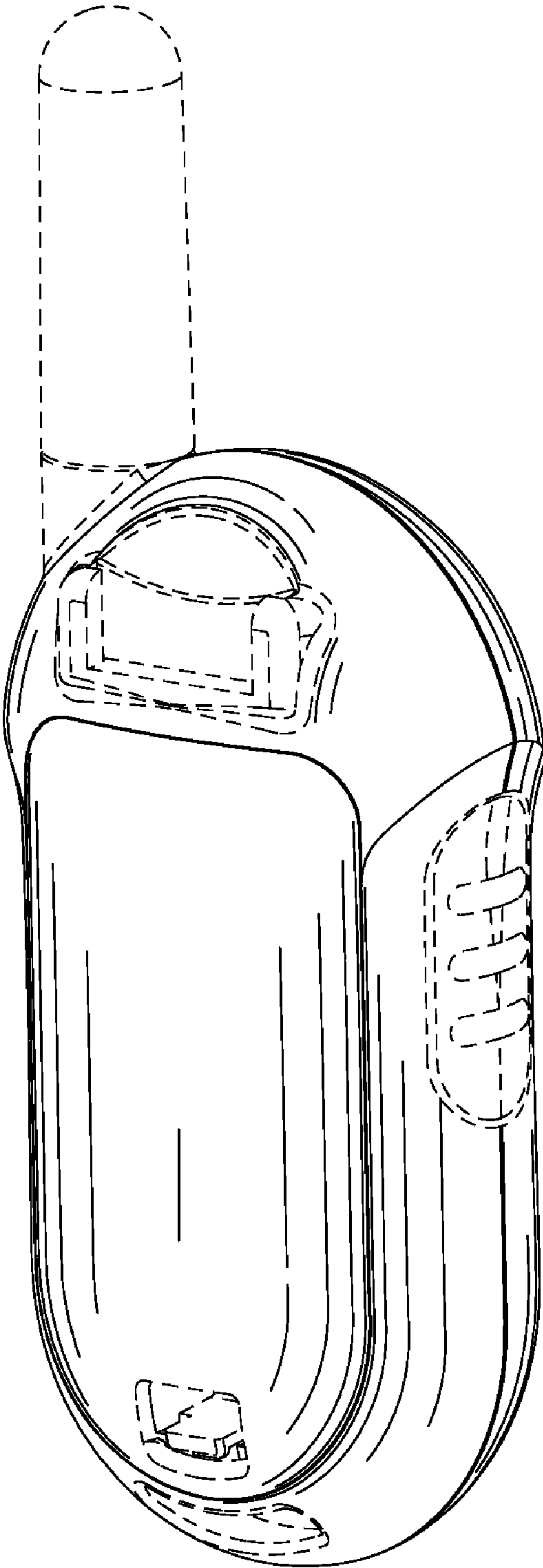

FIG. 2

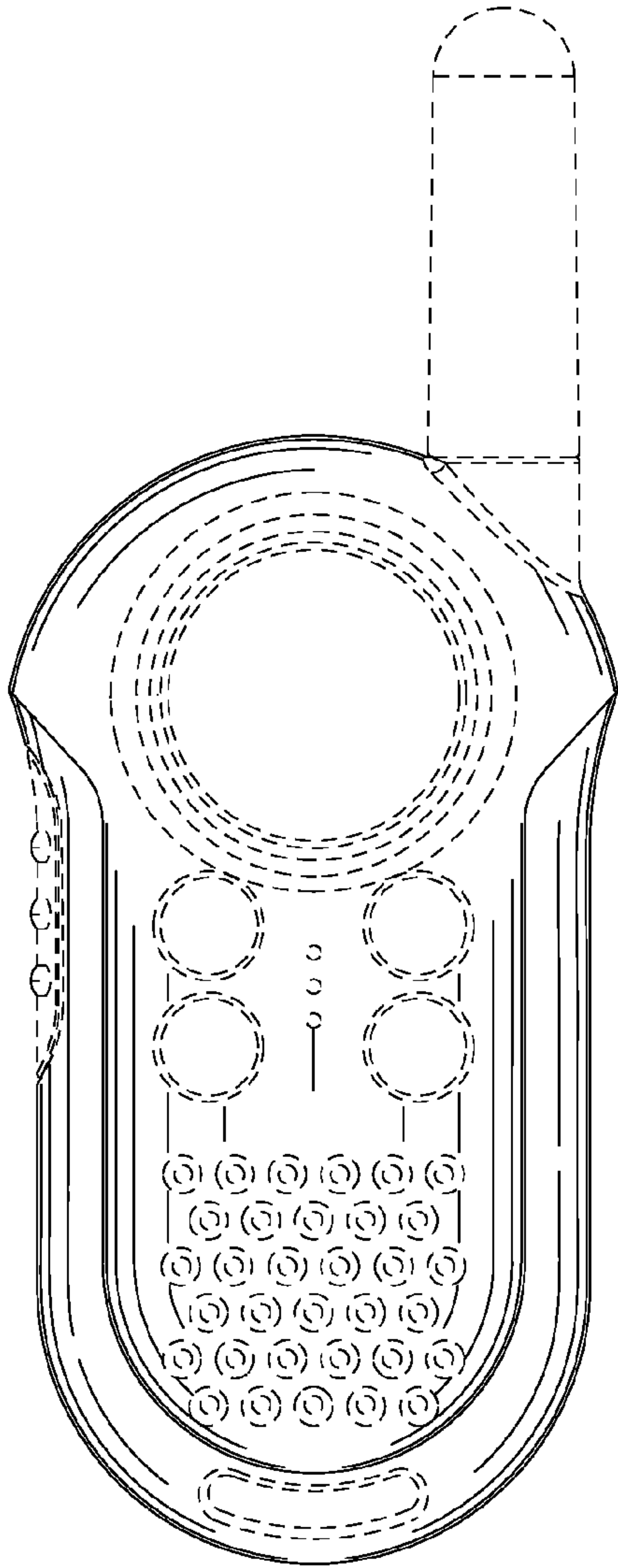

FIG. 3

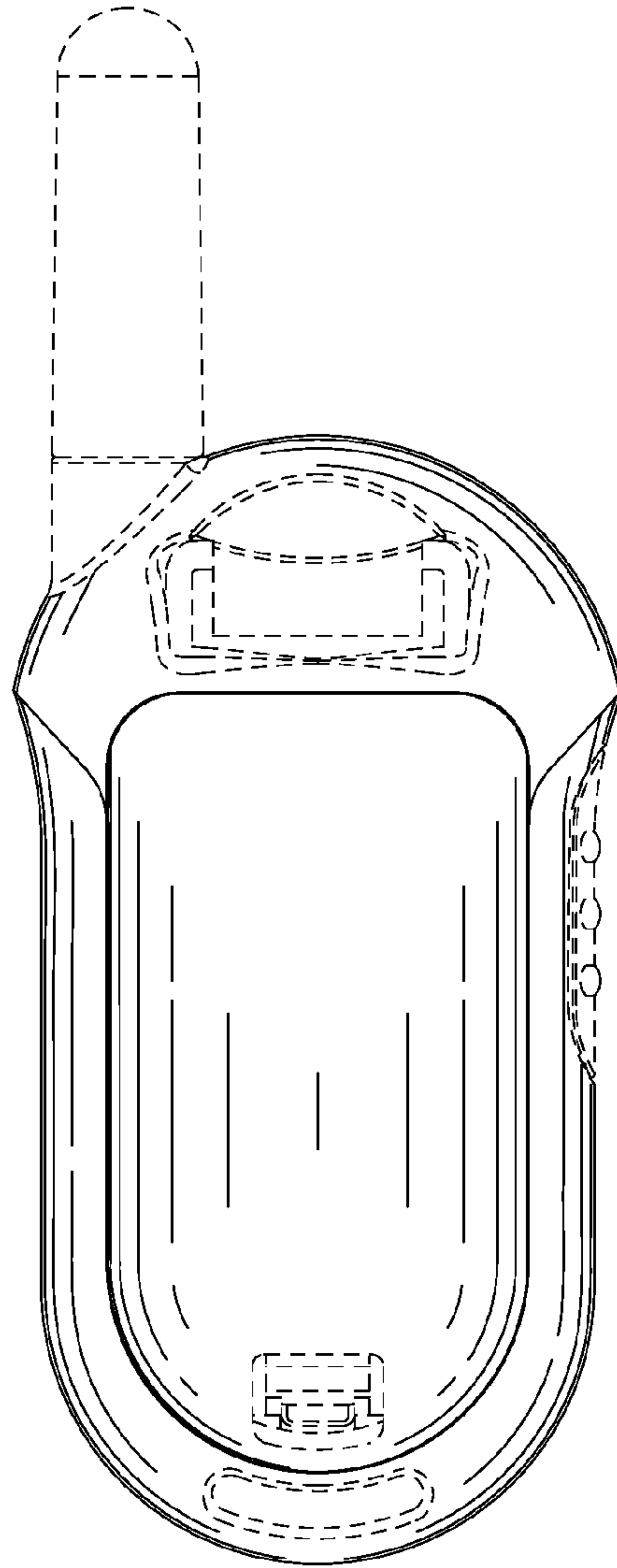

FIG. 4

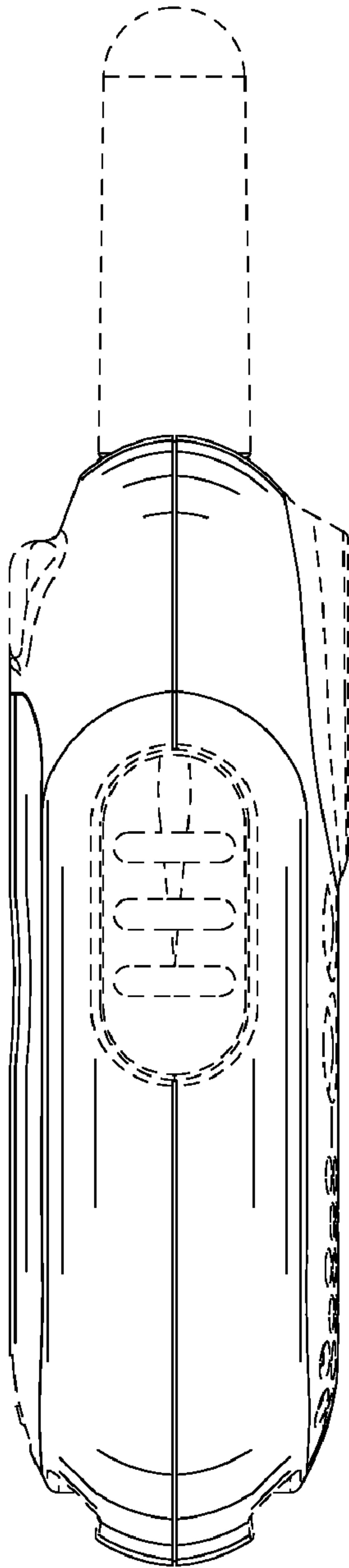

FIG. 5

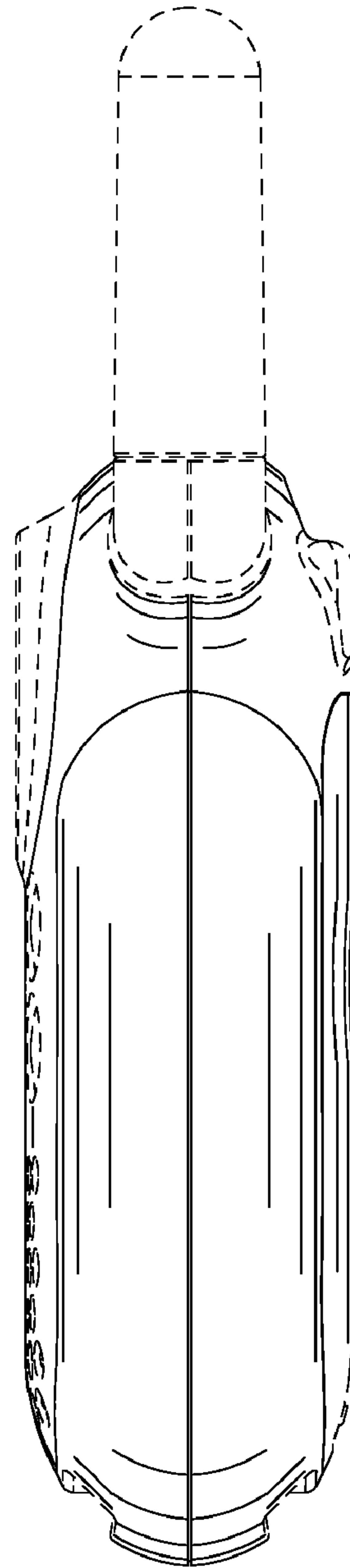

FIG. 6

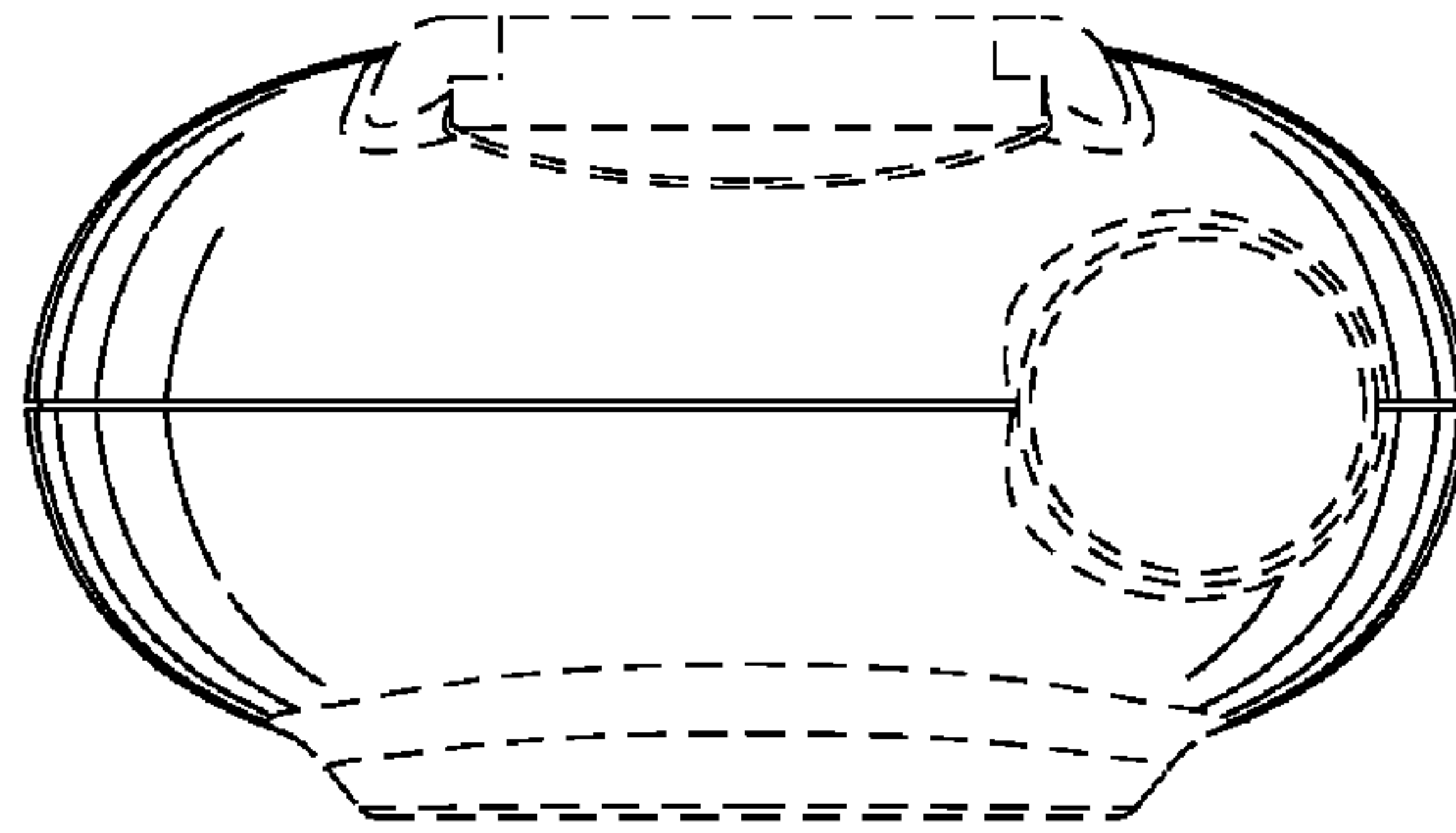

FIG. 7

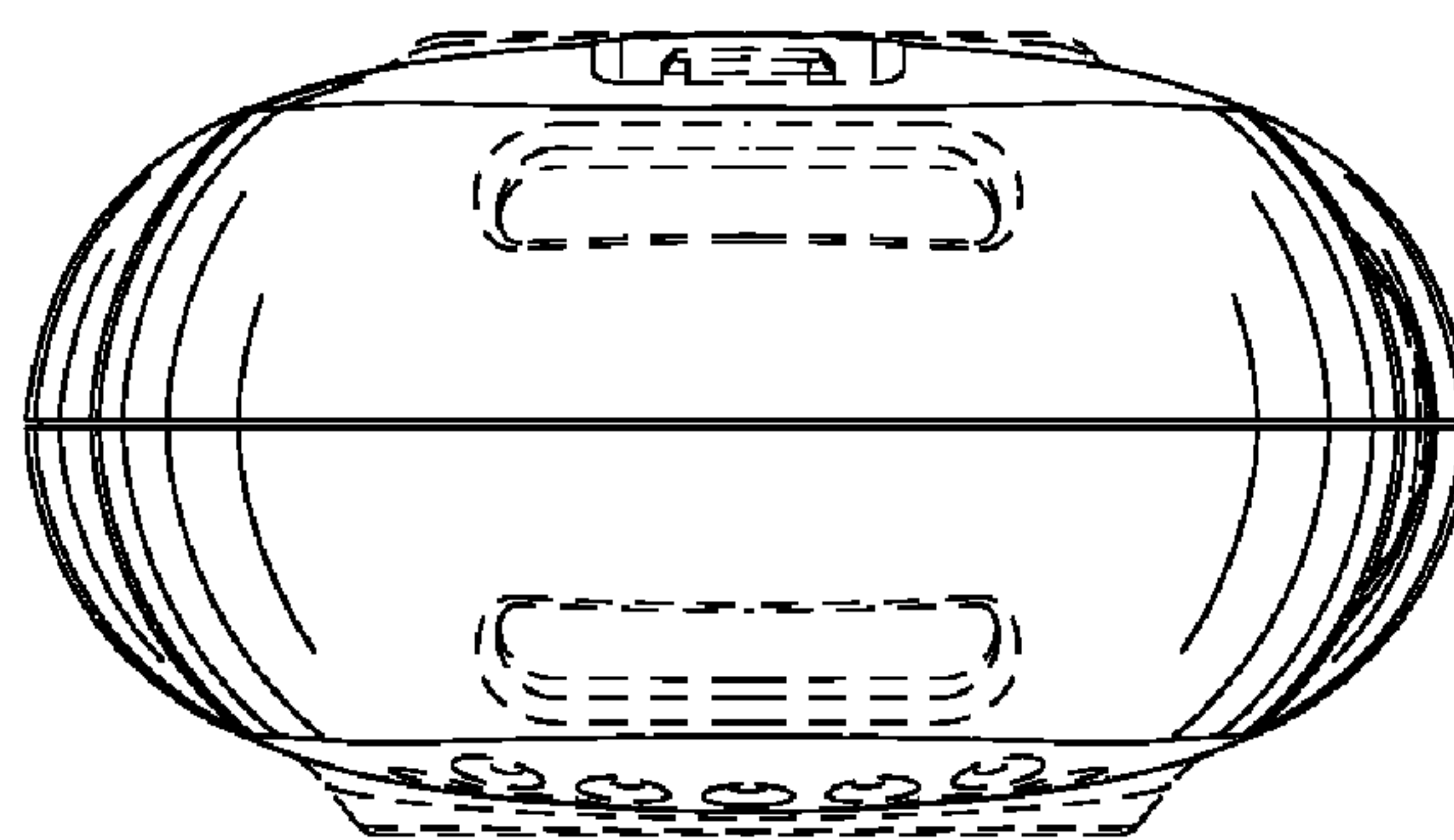

FIG. 8

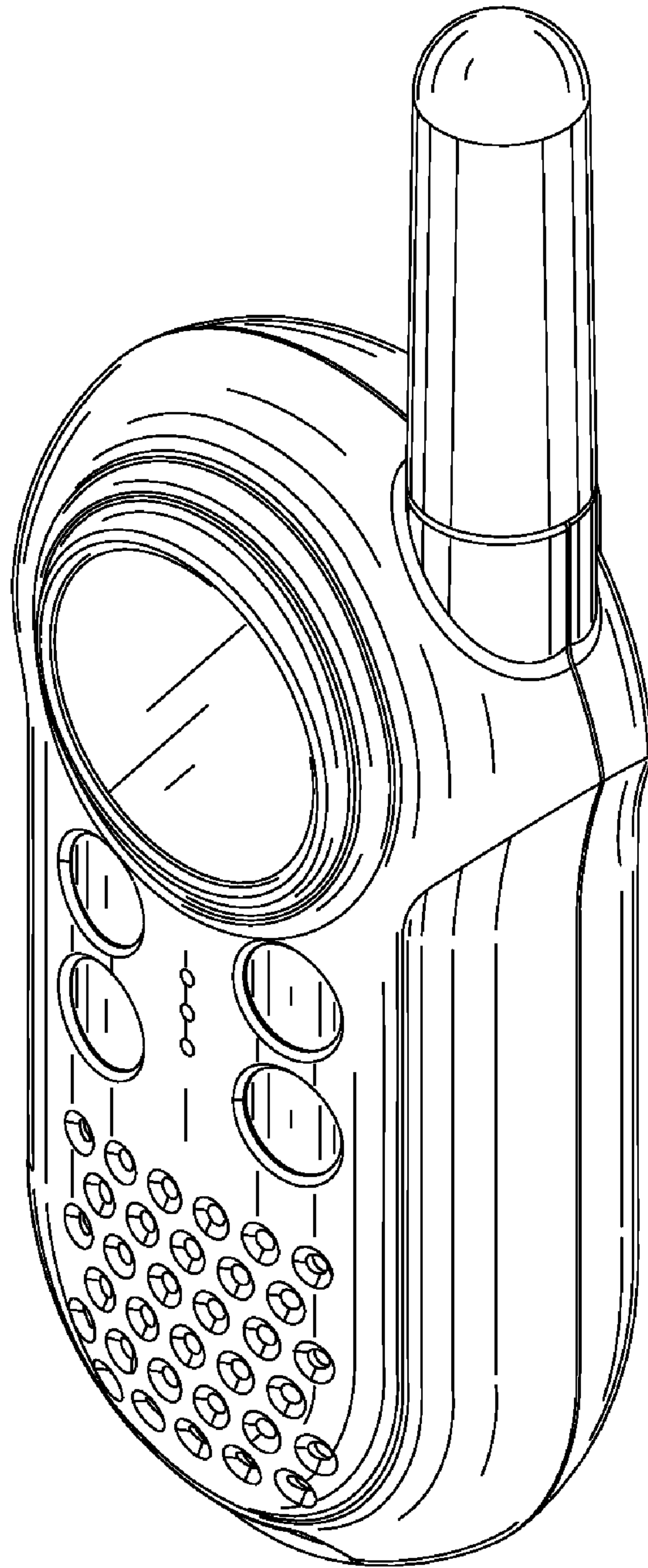

FIG. 9

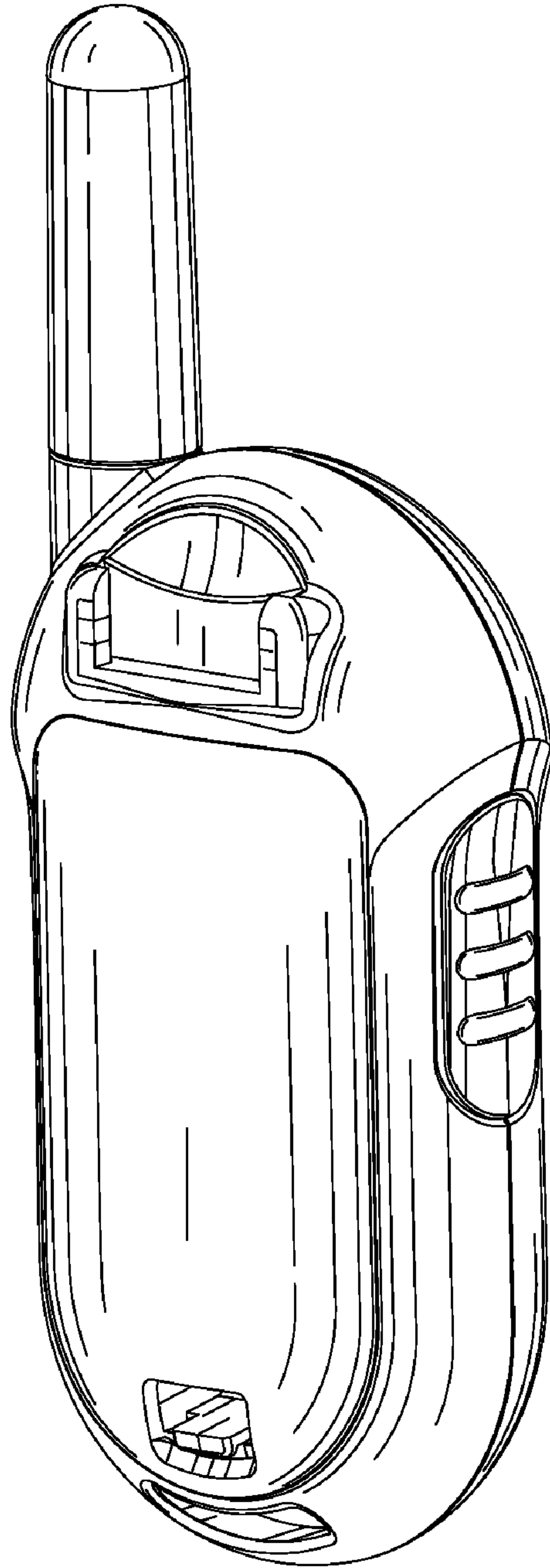

FIG. 10

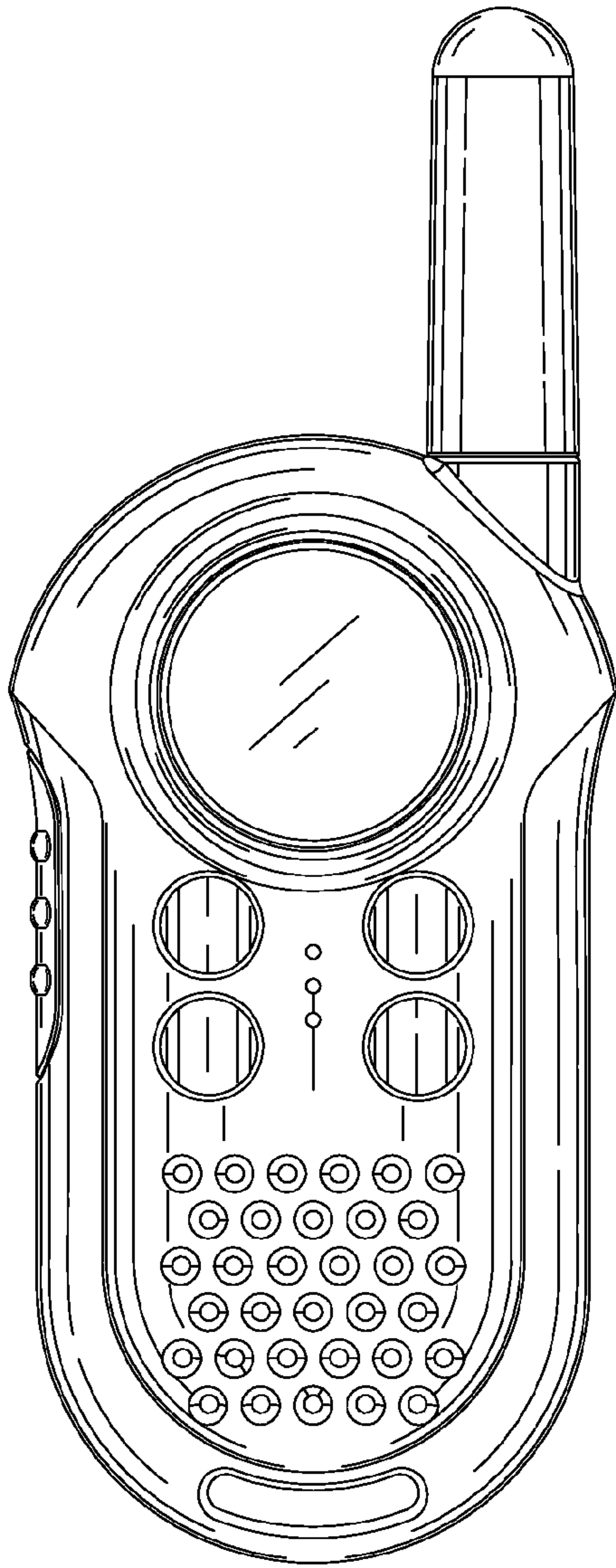

FIG. 11

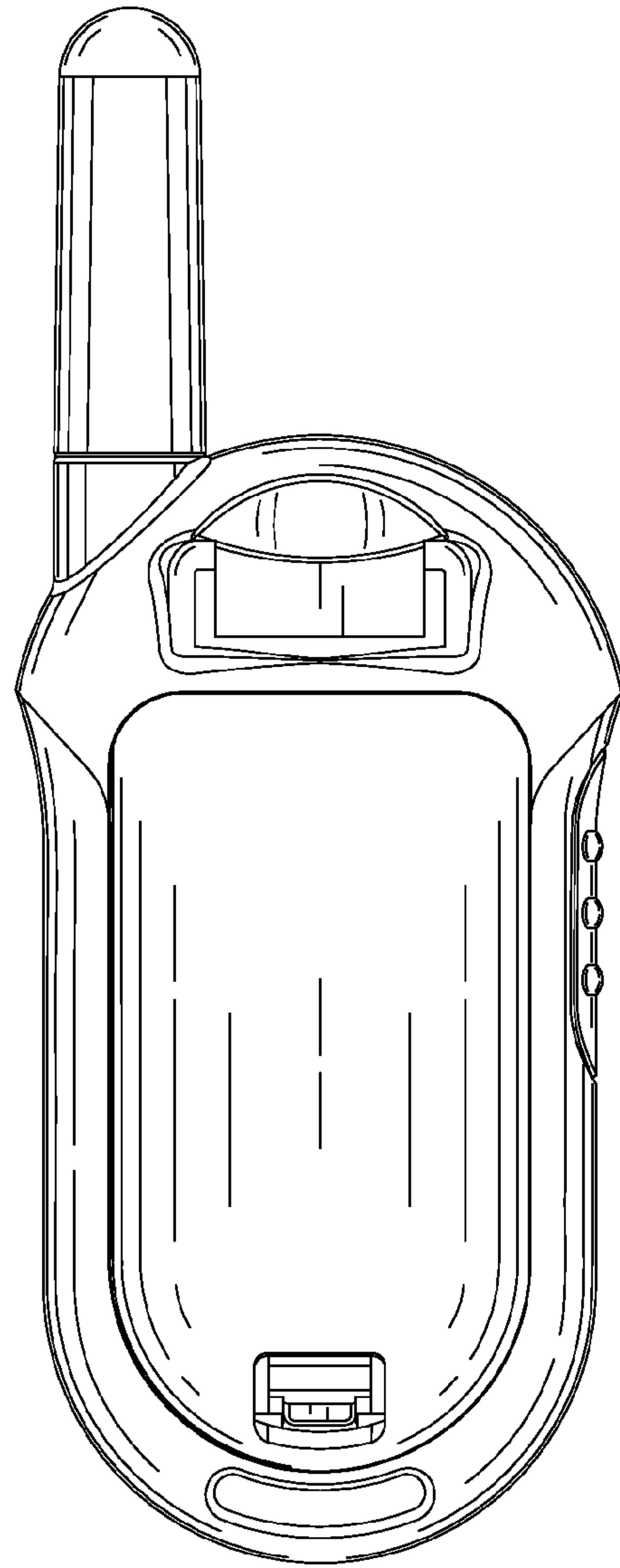

FIG. 12

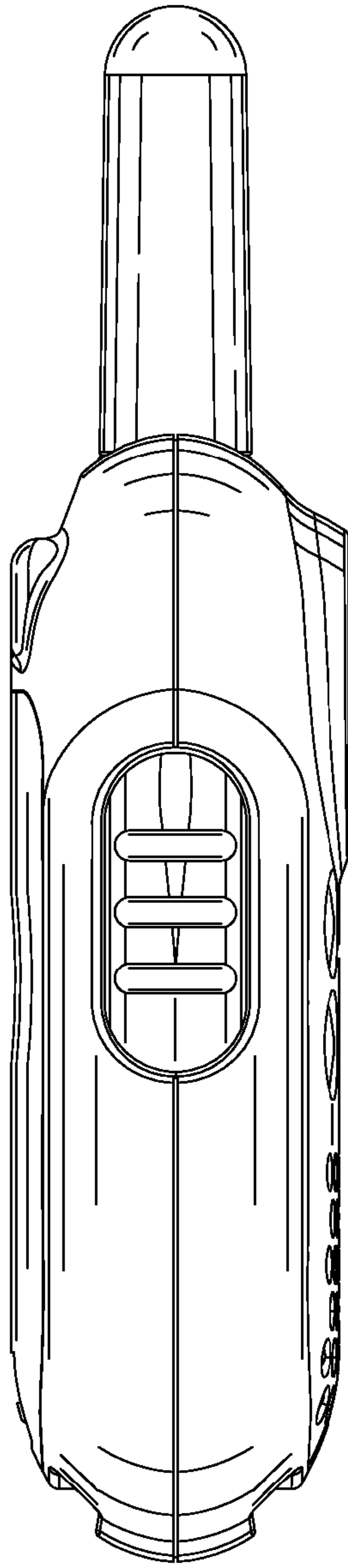

FIG. 13

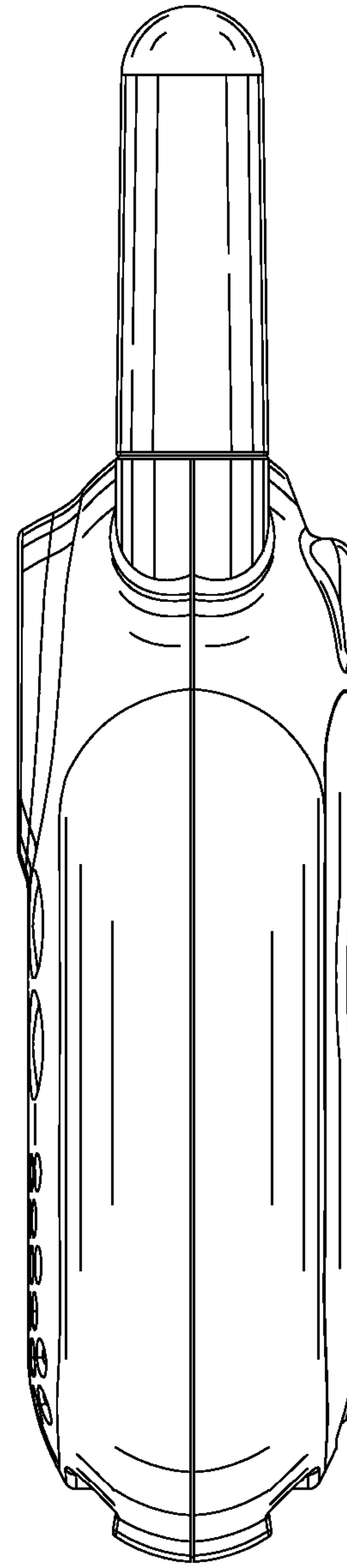

FIG. 14

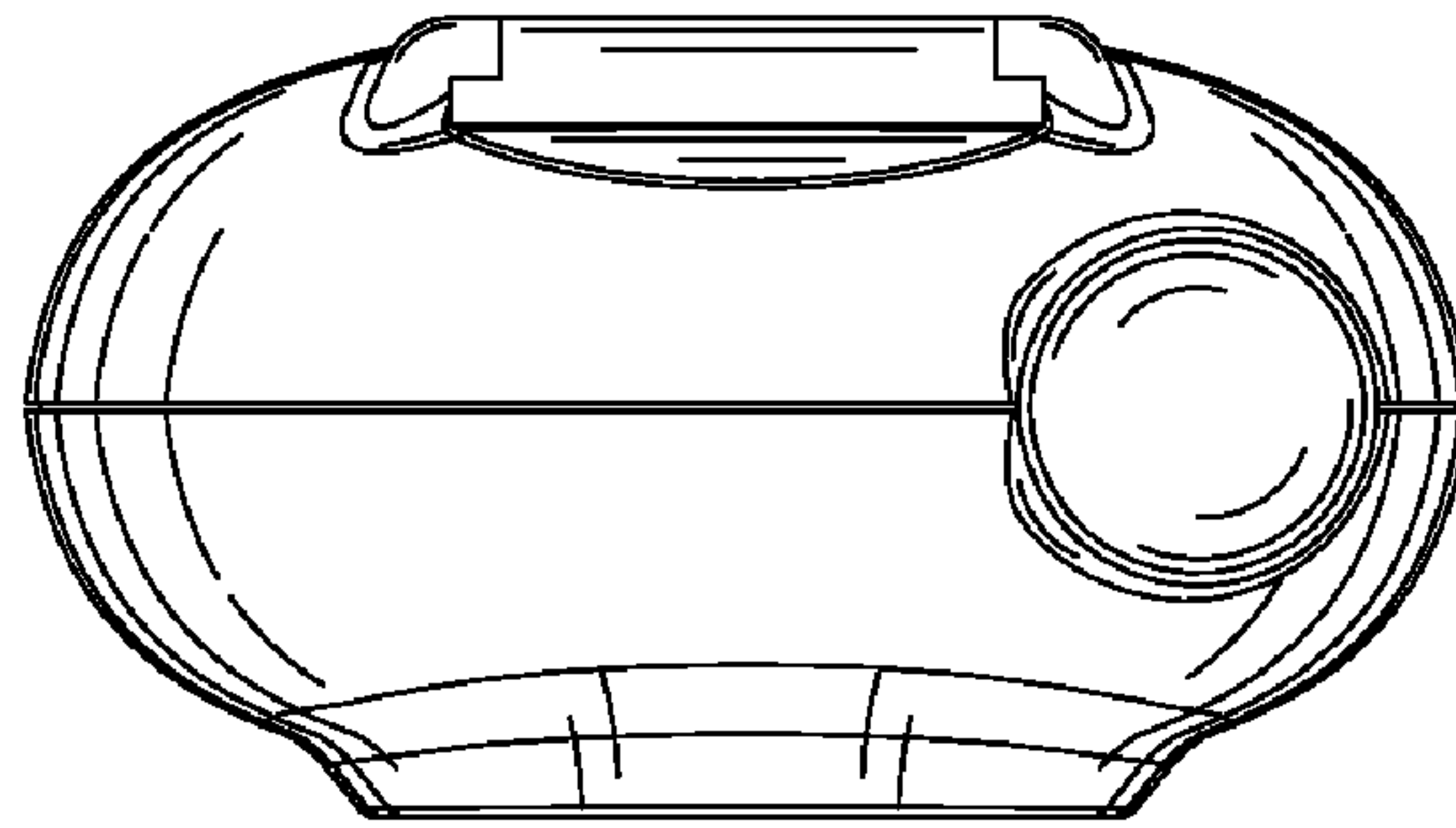

FIG. 15

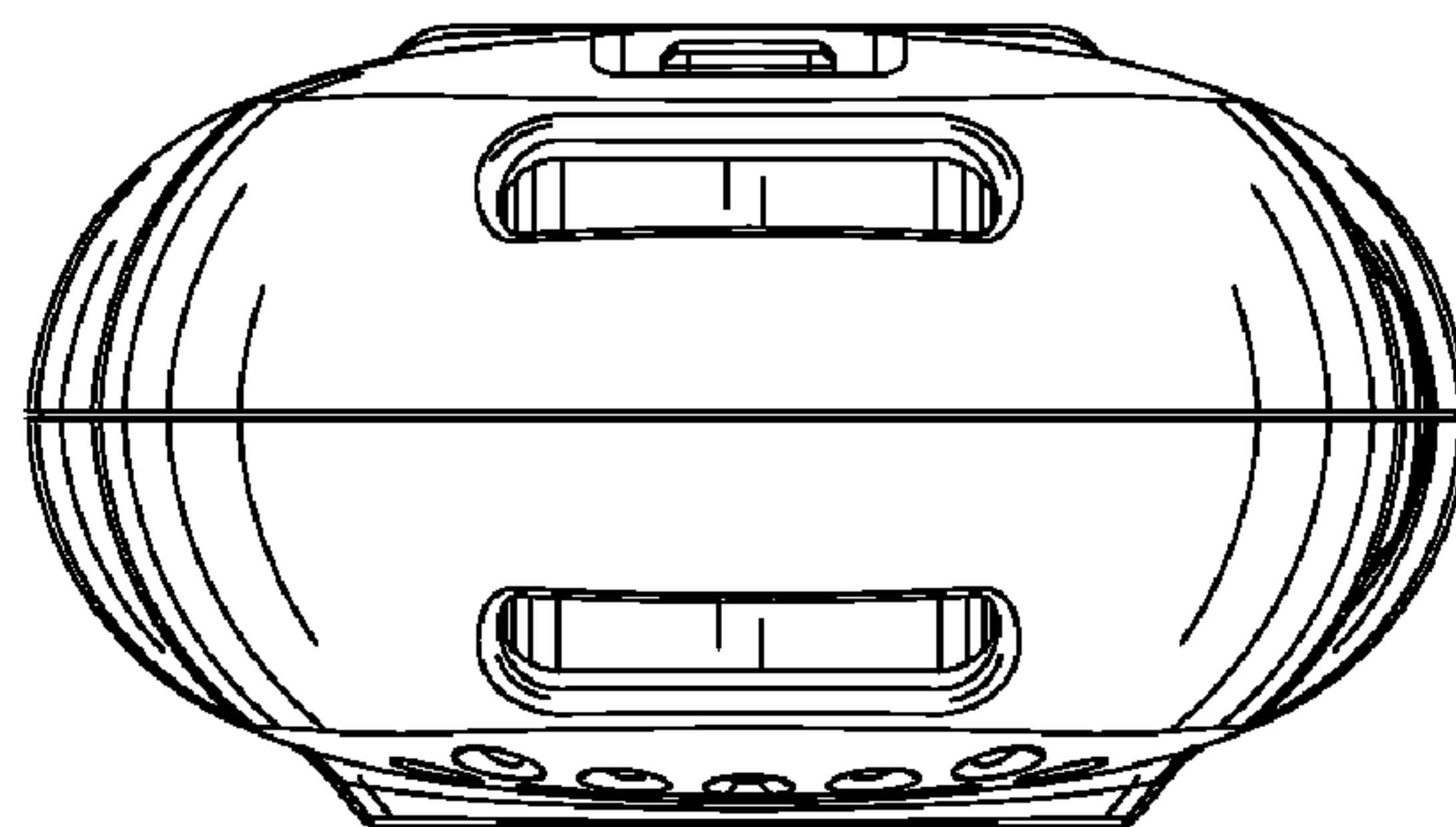

FIG. 16