



US00D632216S

(12) **United States Design Patent**
Shani et al.

(10) **Patent No.:** **US D632,216 S**
(45) **Date of Patent:** **** Feb. 8, 2011**

(54) **BELT BUCKLE**

(76) Inventors: **Tal Shani**, 13 Kaplan St., Petach Tikva (IL) 49451; **Micky Weinstein**, 43/6 Hafetz Haim St., Petach Tikva (IL) 49350

(**) Term: **14 Years**

(21) Appl. No.: **29/365,366**

(22) Filed: **Jul. 8, 2010**

Related U.S. Application Data

(62) Division of application No. 29/345,963, filed on Oct. 23, 2009.

(30) **Foreign Application Priority Data**

Apr. 23, 2009	(IL)	47602
Apr. 23, 2009	(IL)	47603
Apr. 23, 2009	(IL)	47604
Apr. 23, 2009	(IL)	47605
Apr. 23, 2009	(IL)	47606

(51) **LOC (9) Cl.** **02-07**

(52) **U.S. Cl.** **D11/216**

(58) **Field of Classification Search** D11/1-2, D11/200-201, 203-206, 210, 212, 214-219, D11/222, 224, 226; 24/163 R, 169-171, 24/173, 177-179, 191, 194-195, 197, 200

See application file for complete search history.

(56) **References Cited**

U.S. PATENT DOCUMENTS

2,110,684 A 3/1938 Schuhmann 24/313

(Continued)

Primary Examiner—Ralf Seifert

(74) *Attorney, Agent, or Firm*—Ostrolenk Faber LLP

(57) **CLAIM**

We claim the ornamental design for a belt buckle, as shown and described herein.

DESCRIPTION

FIG. 1 is a perspective top view of a belt buckle according to an embodiment of our new design.

FIG. 2 is a perspective bottom view thereof.

FIG. 3 is a perspective top view thereof.

FIG. 4 is a side view thereof.

FIG. 5 is a side view thereof.

FIG. 6 is a side view thereof.

FIG. 7 is a bottom view thereof.

FIG. 8 is a top view thereof.

FIG. 9 is a top view thereof.

FIG. 10 is a bottom view thereof.

FIG. 11 is a side view thereof.

FIG. 12 is a front view thereof.

FIG. 13 is a rear view thereof.

FIG. 14 is a perspective view of the top, front view thereof.

FIG. 15 is a perspective view of the top, front view thereof.

FIG. 16 is a perspective view of the bottom, rear view thereof.

FIG. 17 is a bottom view thereof.

FIG. 18 is a left side view thereof.

FIG. 19 is a right side view thereof.

FIG. 20 is a top view thereof.

FIG. 21 is a front view thereof.

FIG. 22 is a rear view thereof.

FIG. 23 is a perspective view of the top, front view thereof.

FIG. 24 is a perspective view of the top, front view thereof.

FIG. 25 is a perspective view of the bottom, rear view thereof.

FIG. 26 is a bottom view thereof.

FIG. 27 is an exploded front view thereof.

FIG. 28 is an exploded side view thereof.

FIG. 29 is a top view thereof.

FIG. 30 is an exploded rear view thereof.

FIG. 31 is an exploded side view thereof.

FIG. 32 is an exploded perspective top view thereof.

FIG. 33 is an exploded perspective top view thereof; and,

FIG. 34 is an exploded perspective rear view thereof.

The portions of the drawings appearing in broken lines are for illustrative purposes only and form no part of the claimed design.

1 Claim, 4 Drawing Sheets

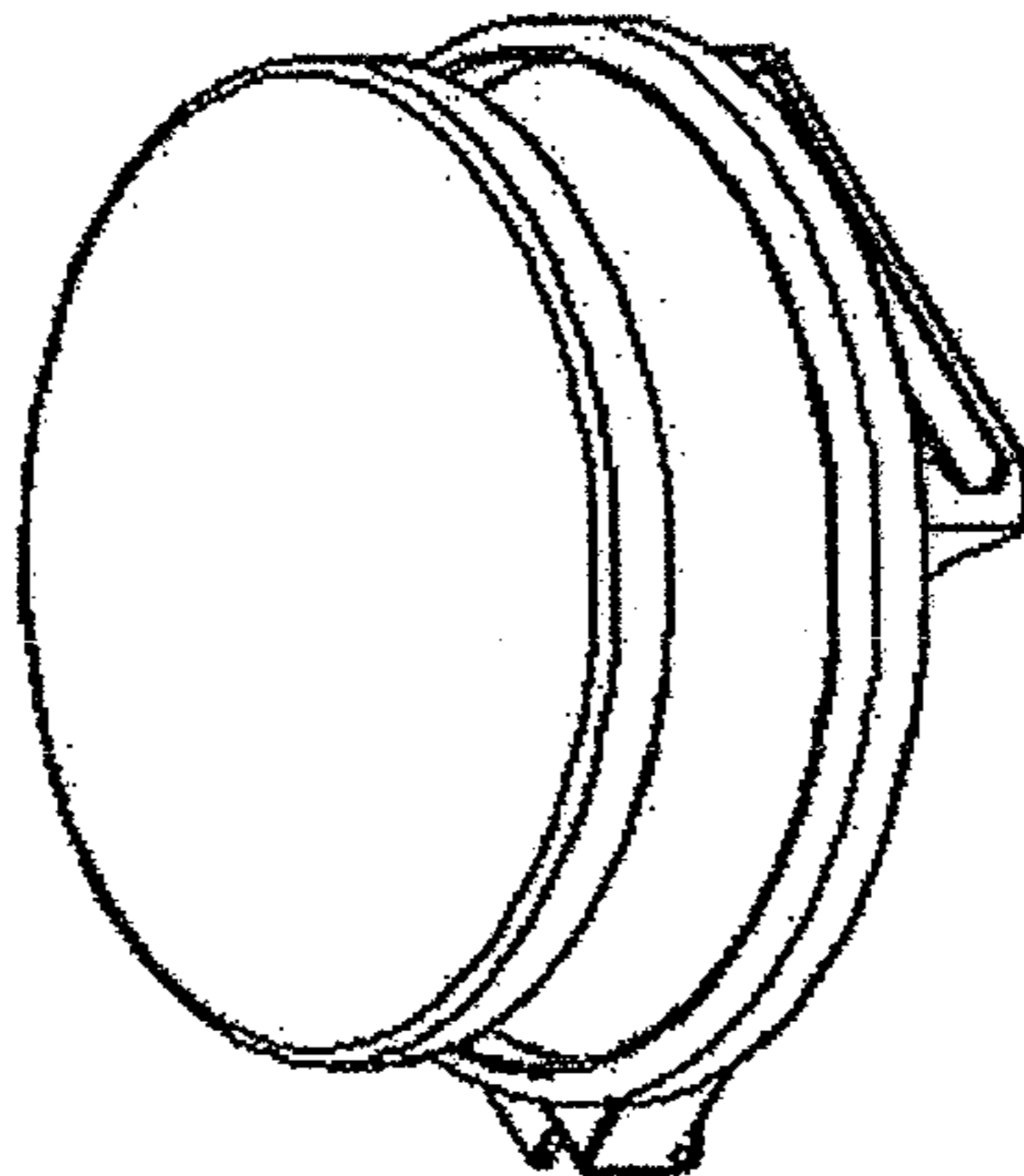

US D632,216 S

Page 2

U.S. PATENT DOCUMENTS

D117,747 S	11/1939	Freysinger	D11/215	D332,585 S	1/1993	Olson	D11/201
2,531,244 A	11/1950	Andrus	24/504	D414,401 S	9/1999	Aganian	D8/383
D177,056 S	3/1956	Lowrie	D11/1	D596,986 S	7/2009	Gastaldi	D11/216
D209,566 S	* 12/1967	Jantzen	D11/216	7,657,978 B2	2/2010	Lin	24/614

* cited by examiner

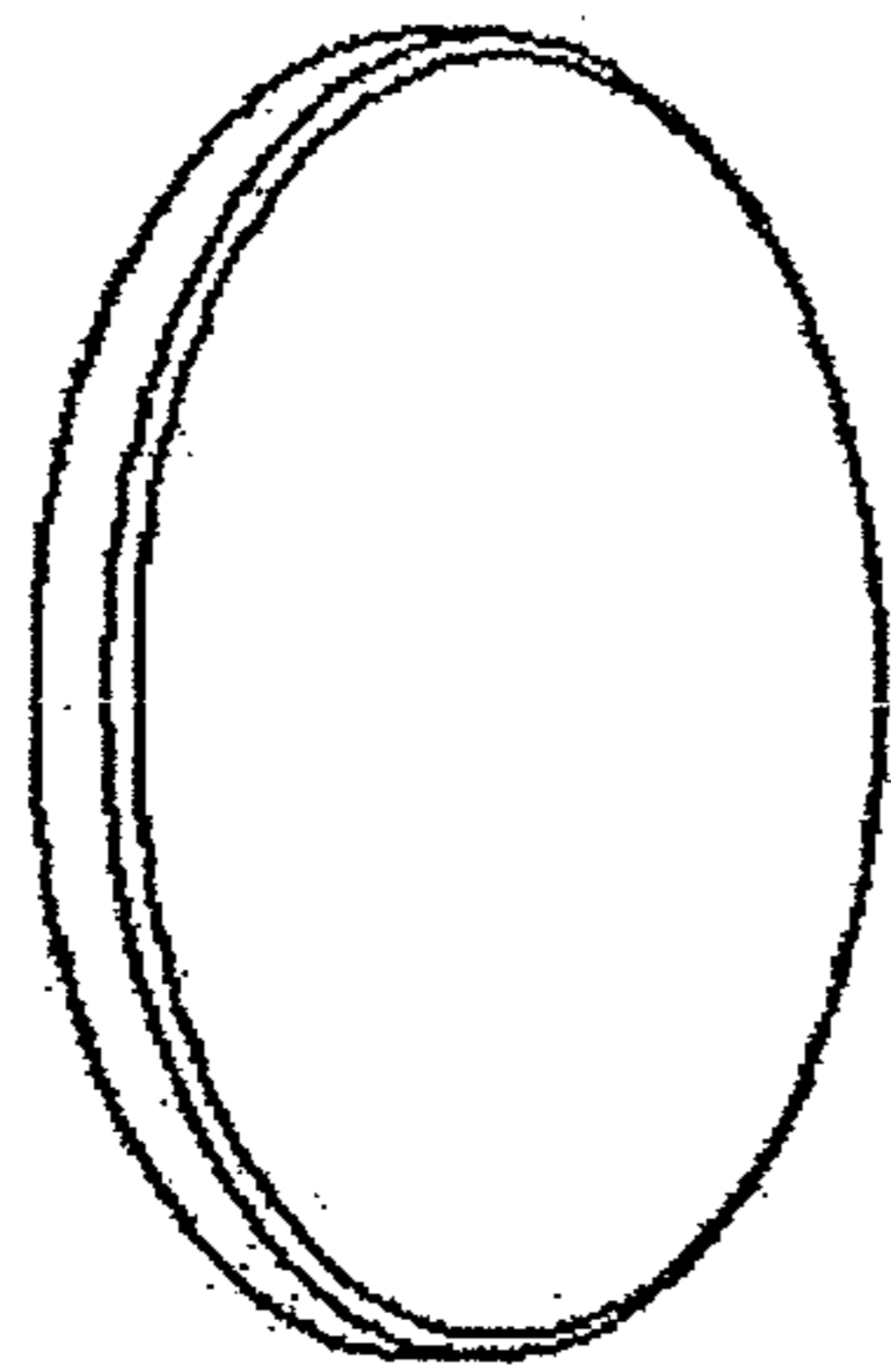

Fig. 1

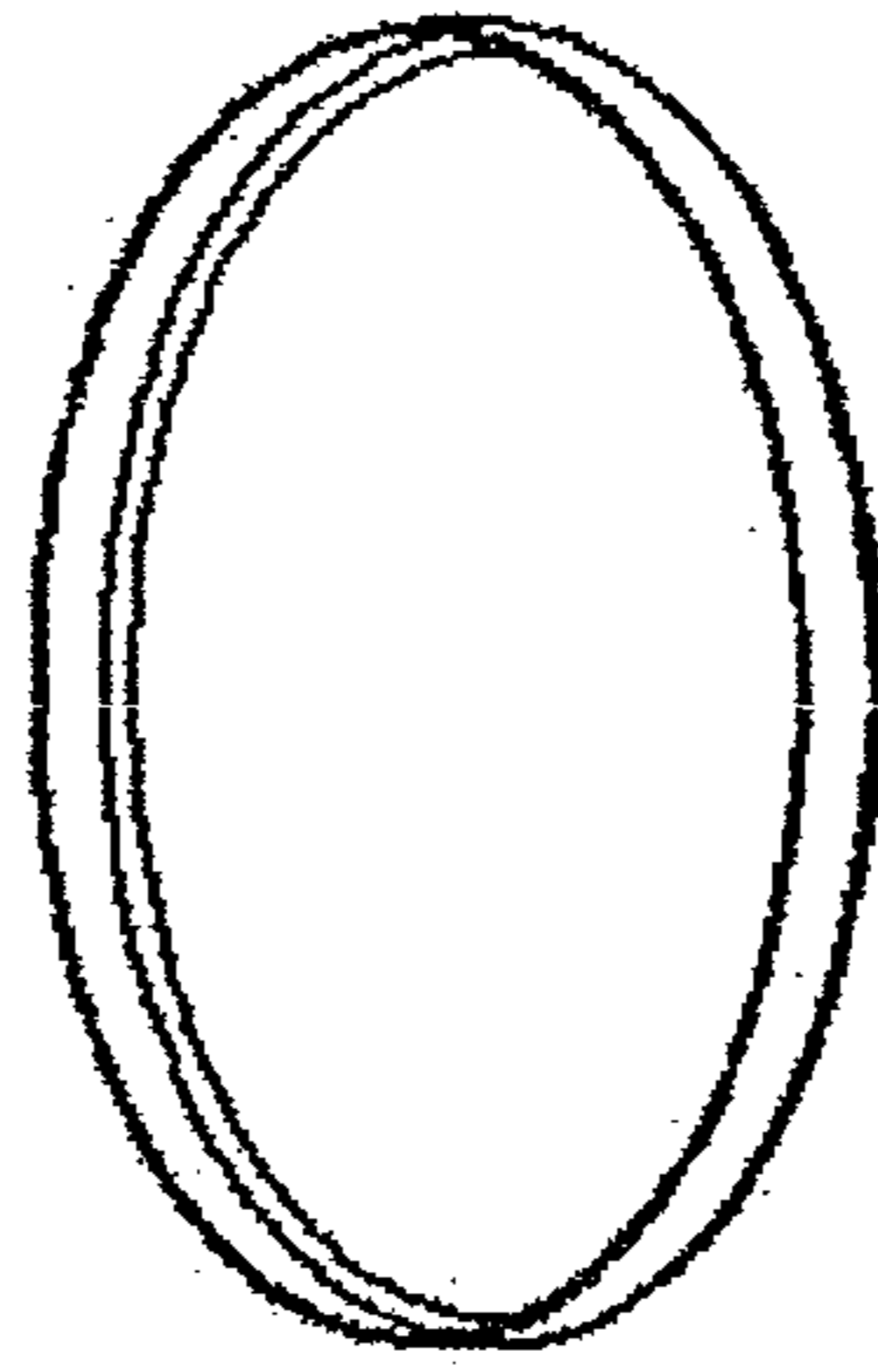

Fig. 2

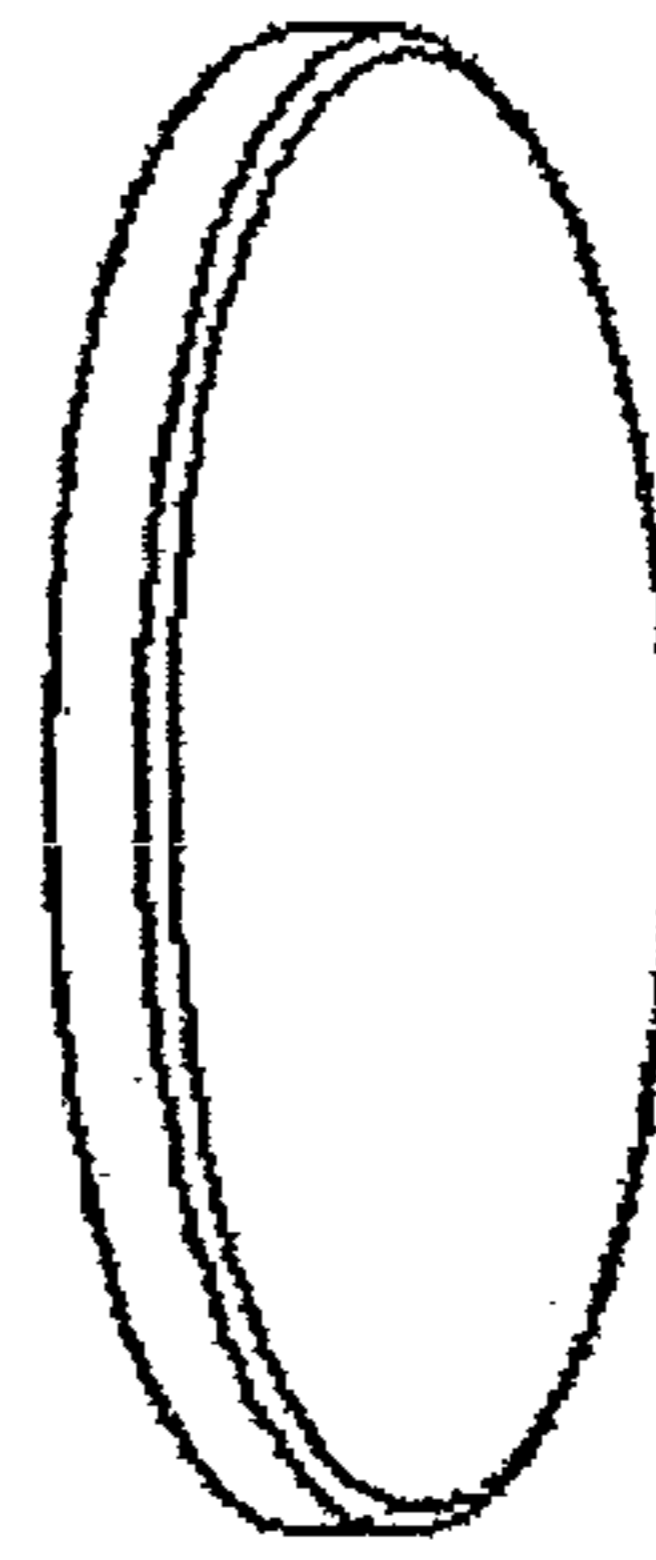

Fig. 3



Fig. 4



Fig. 5



Fig. 6

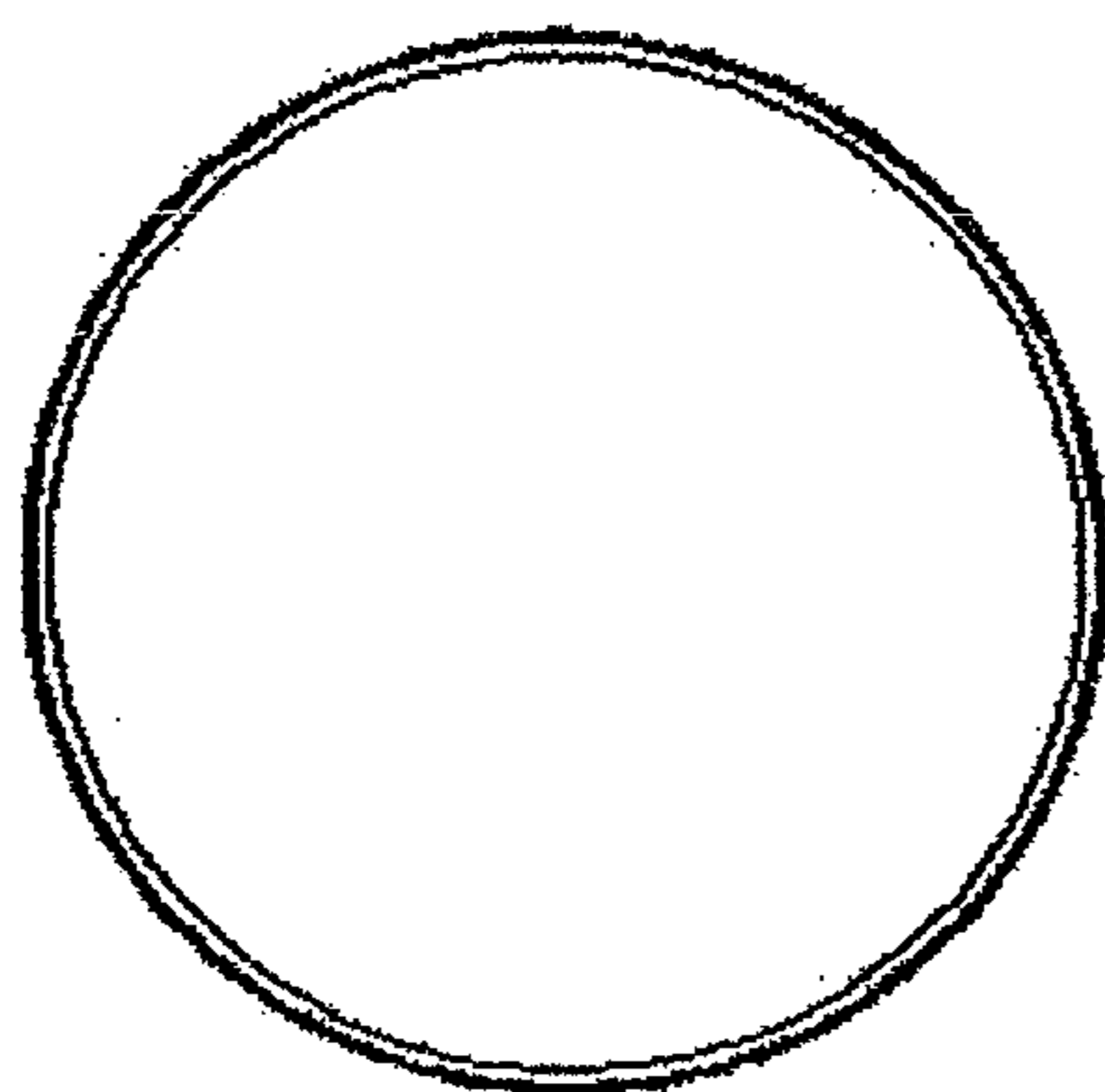

Fig. 7

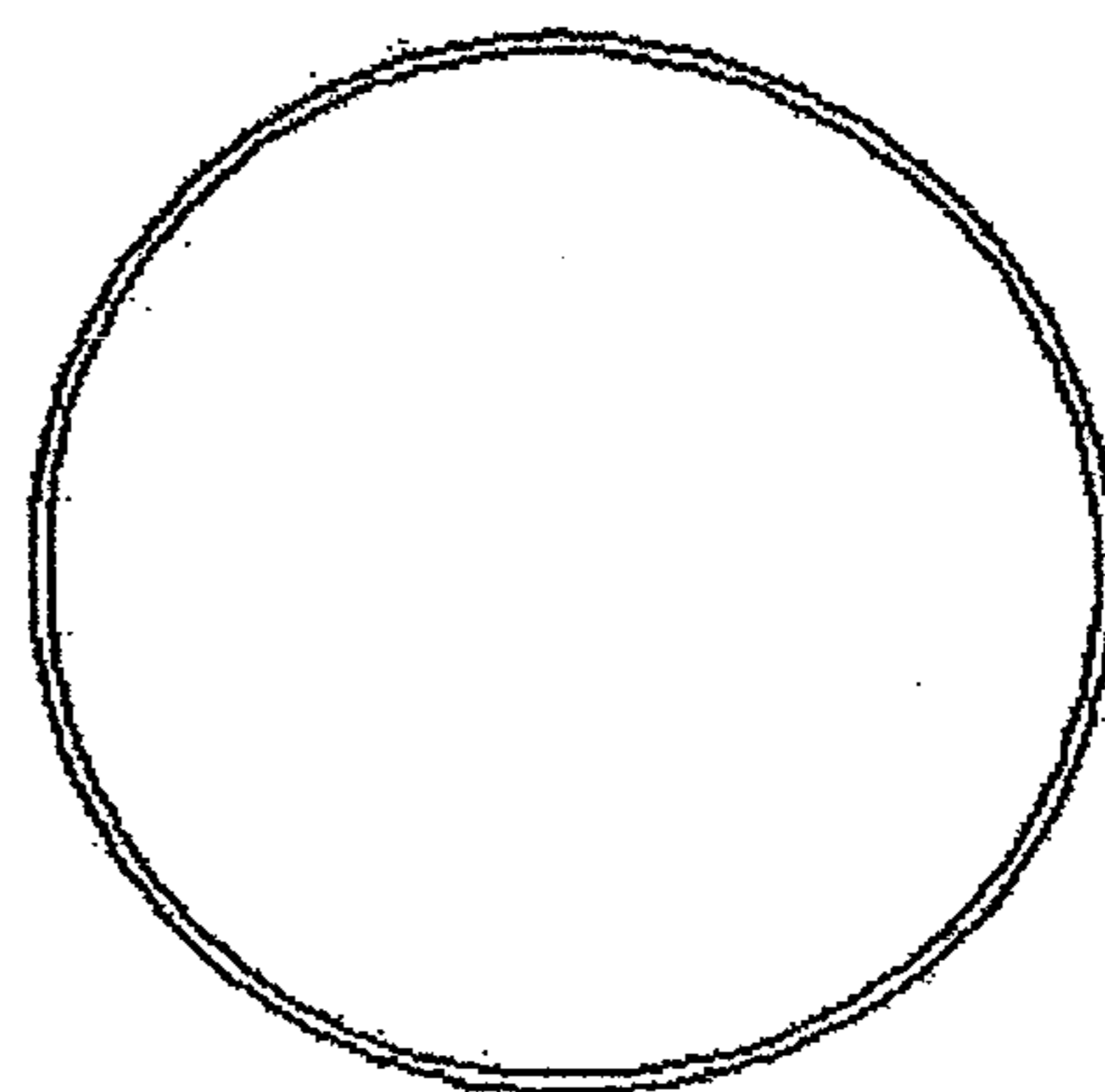

Fig. 8

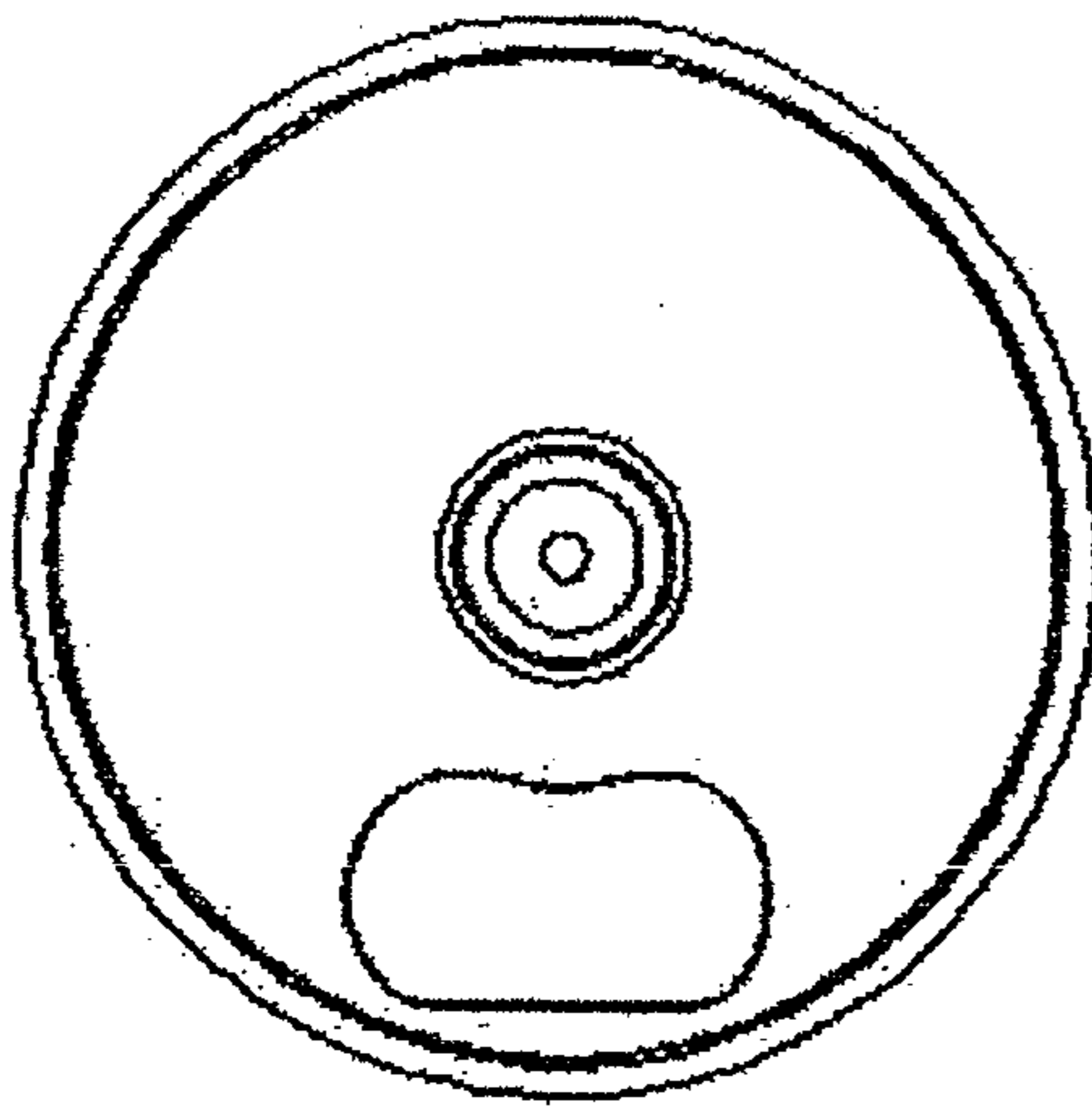

Fig. 9

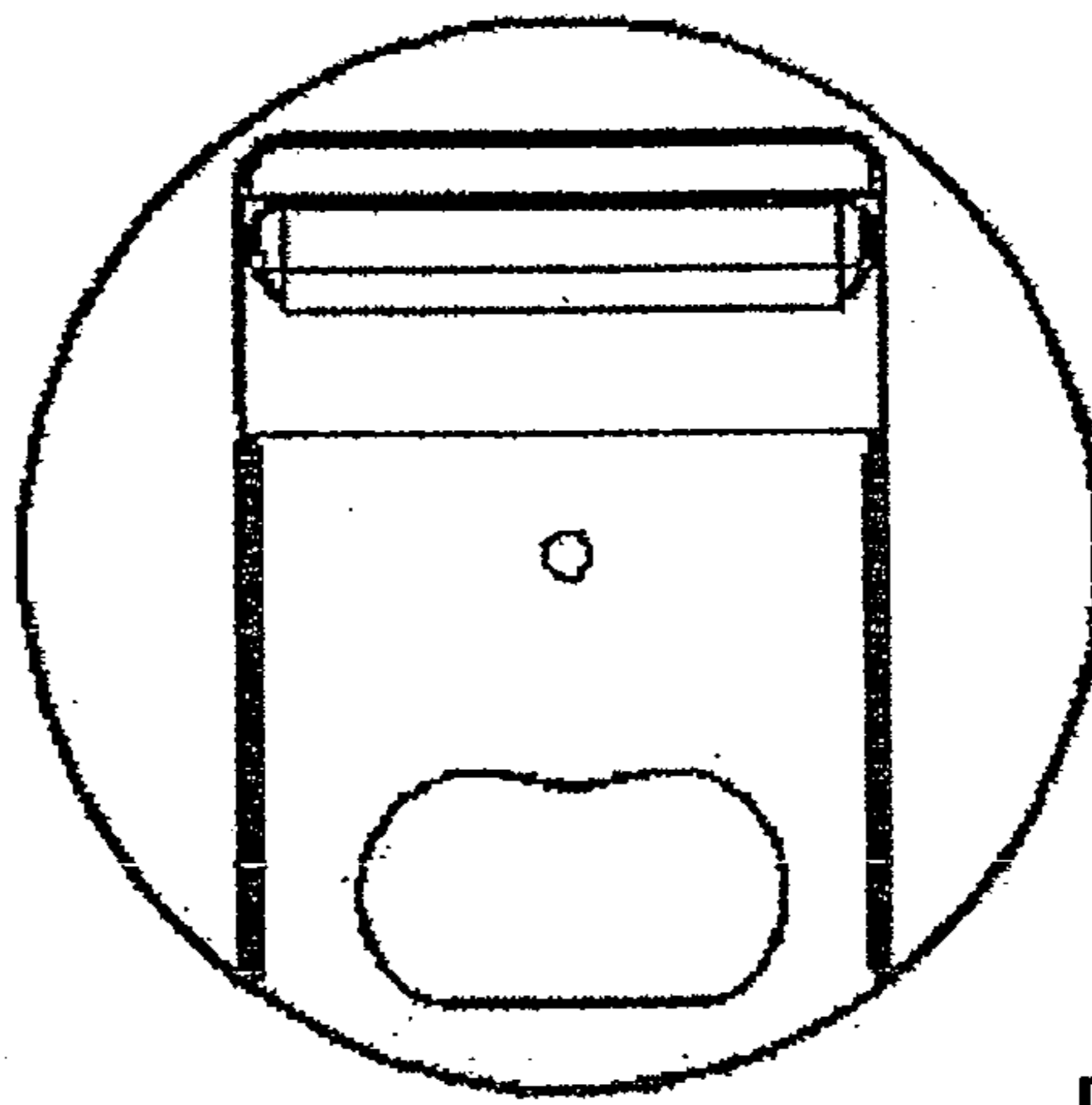

Fig. 10



Fig. 11



Fig. 12



Fig. 13

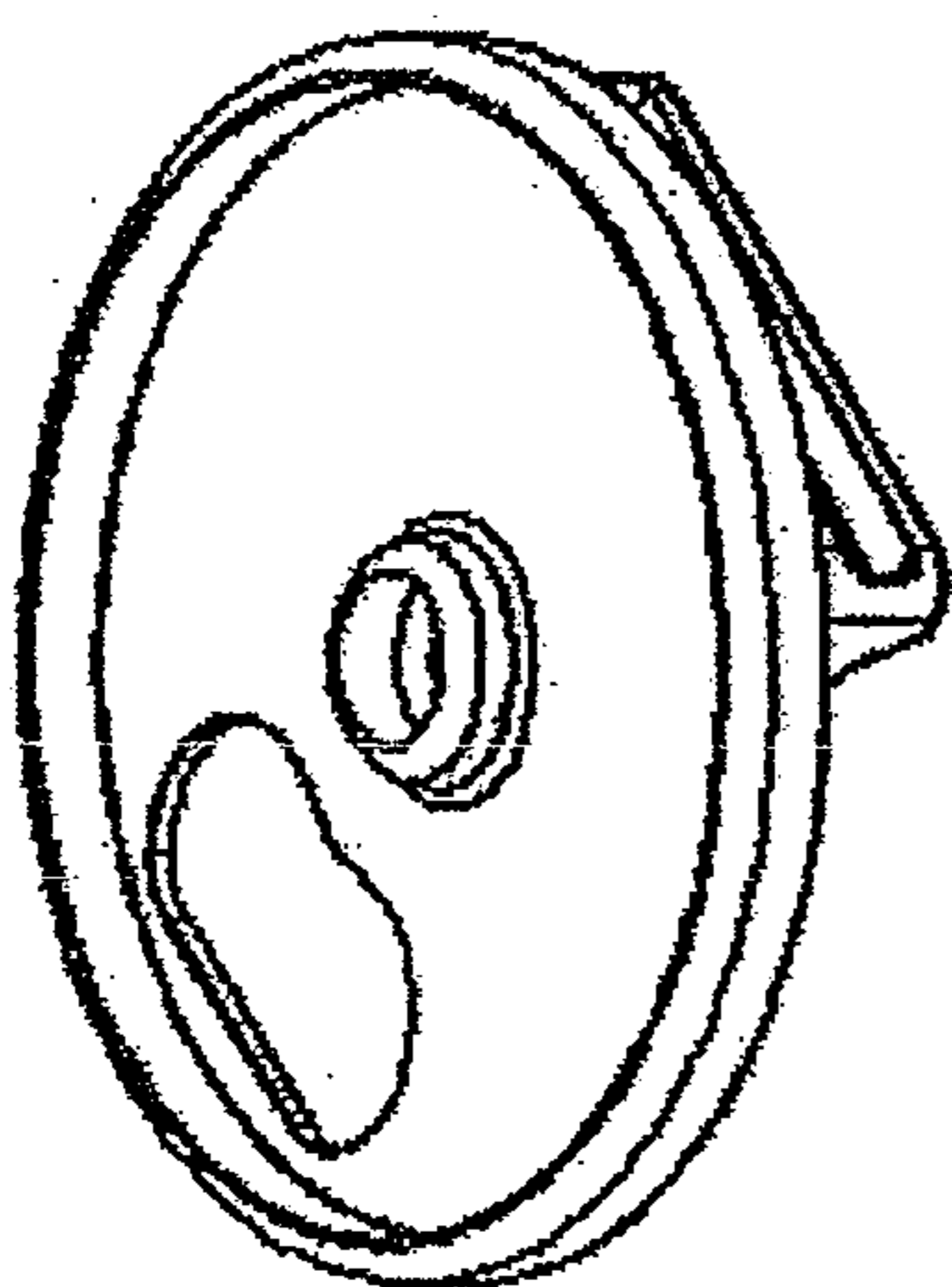

Fig. 14

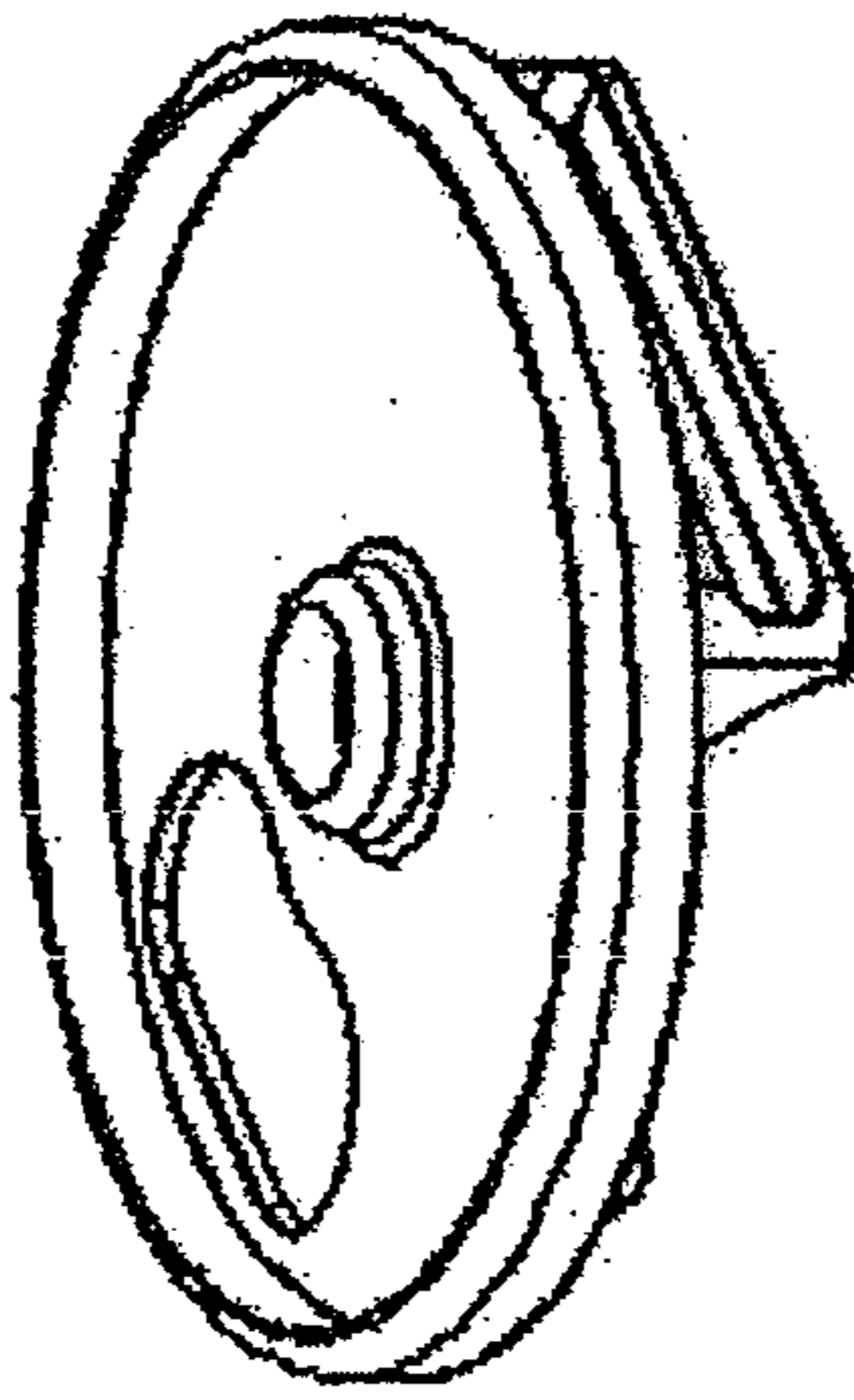

Fig. 15

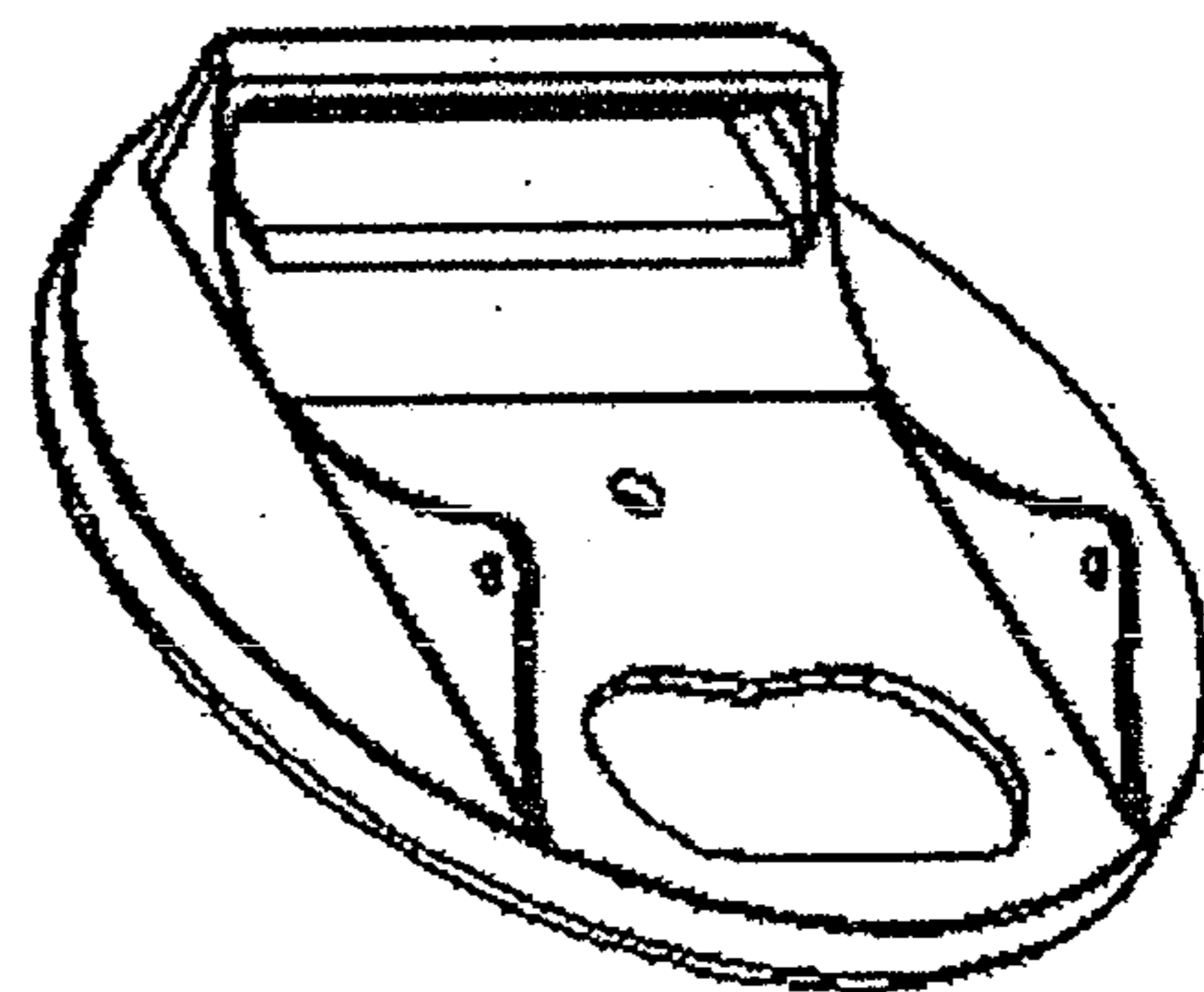

Fig. 16

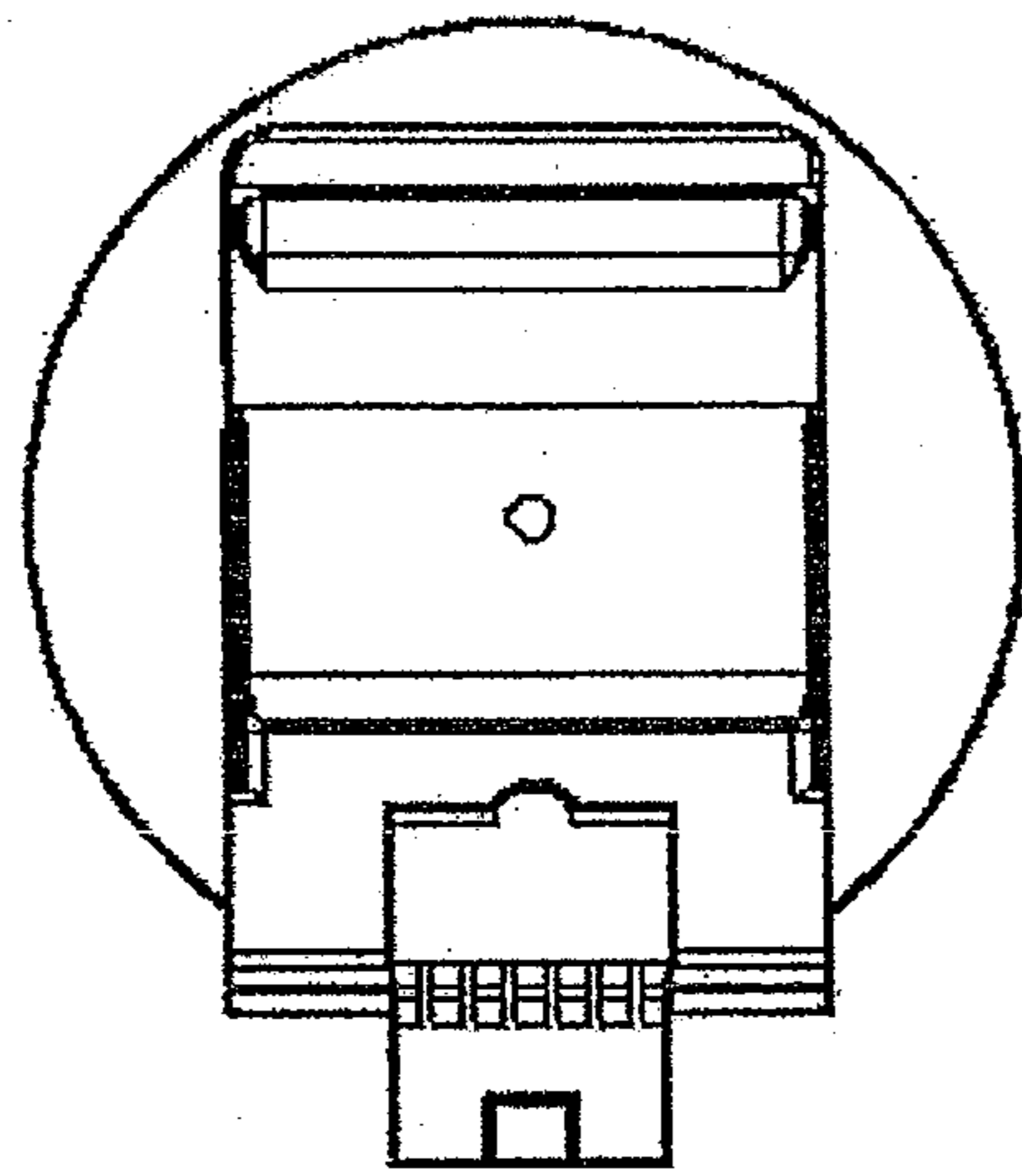

Fig. 17

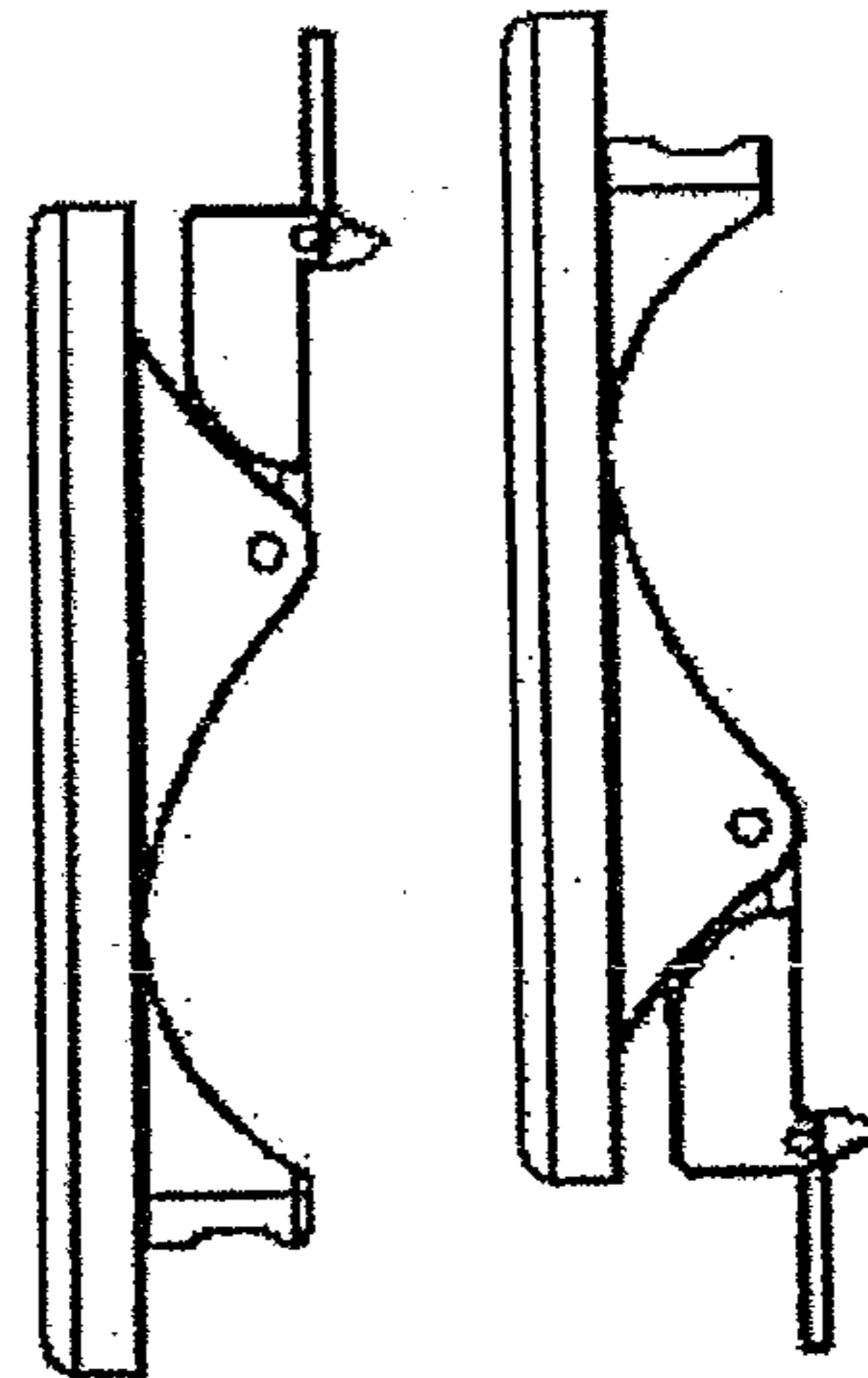

Fig. 18

Fig. 19

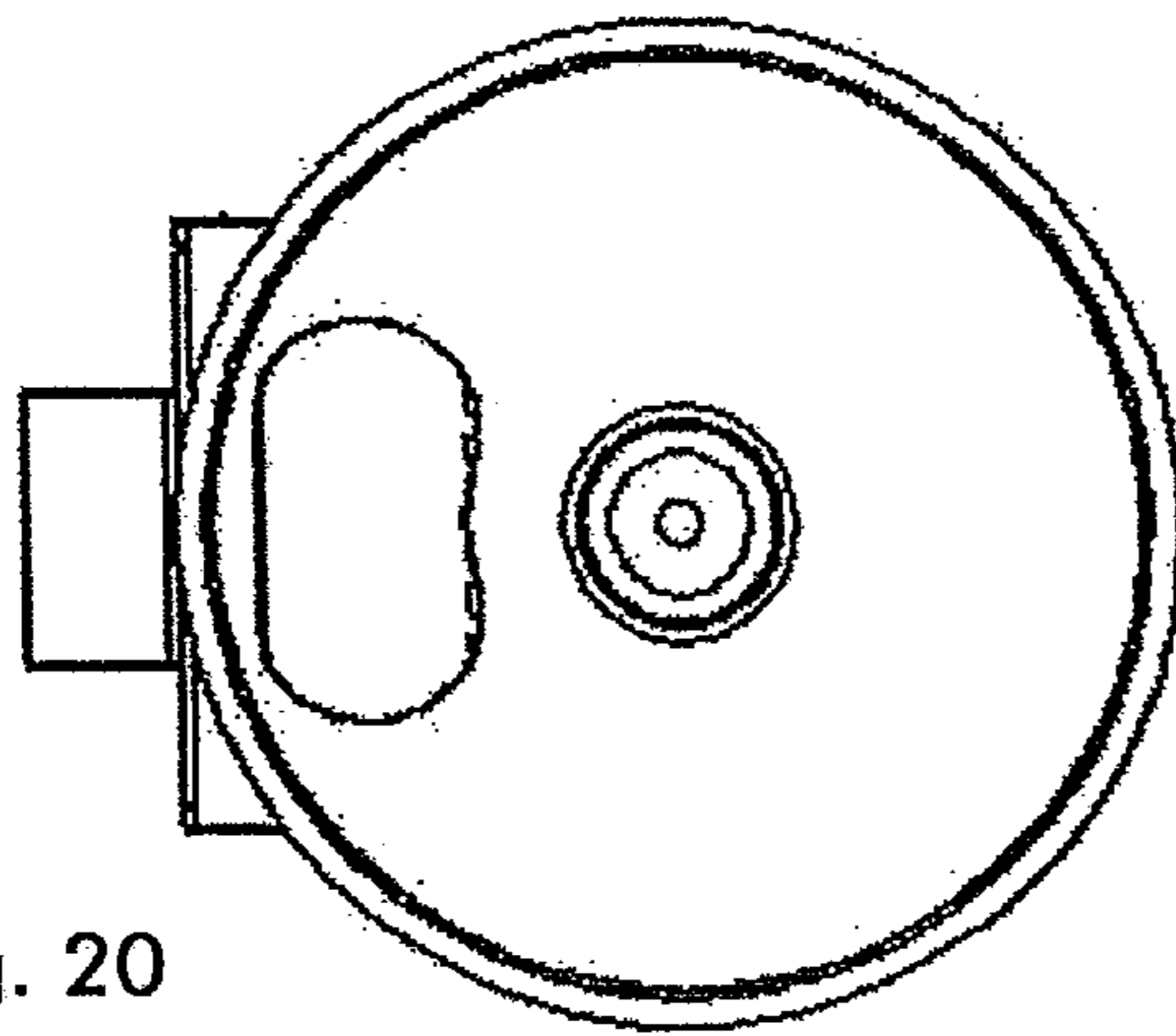

Fig. 20

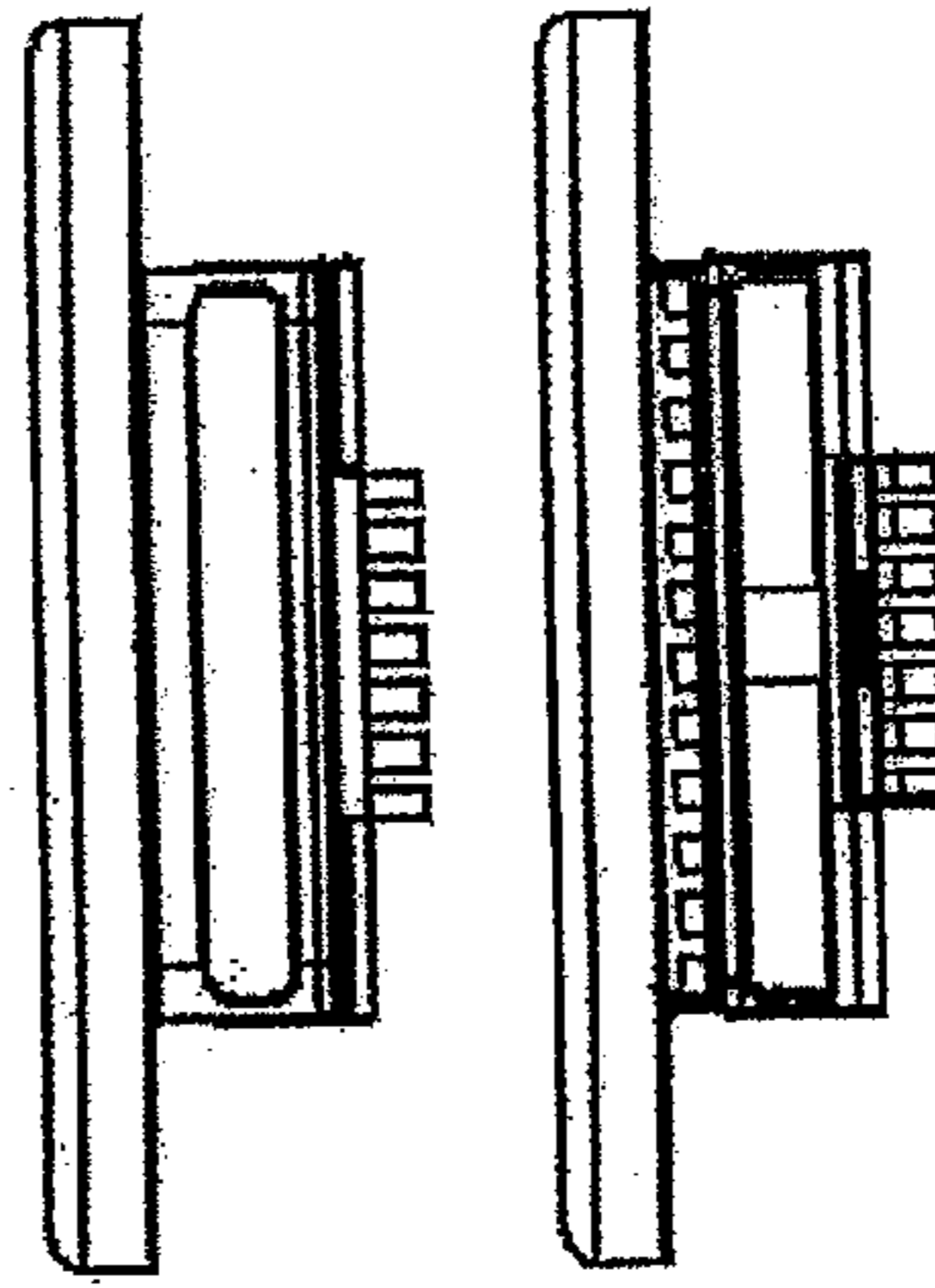

Fig. 21

Fig. 22

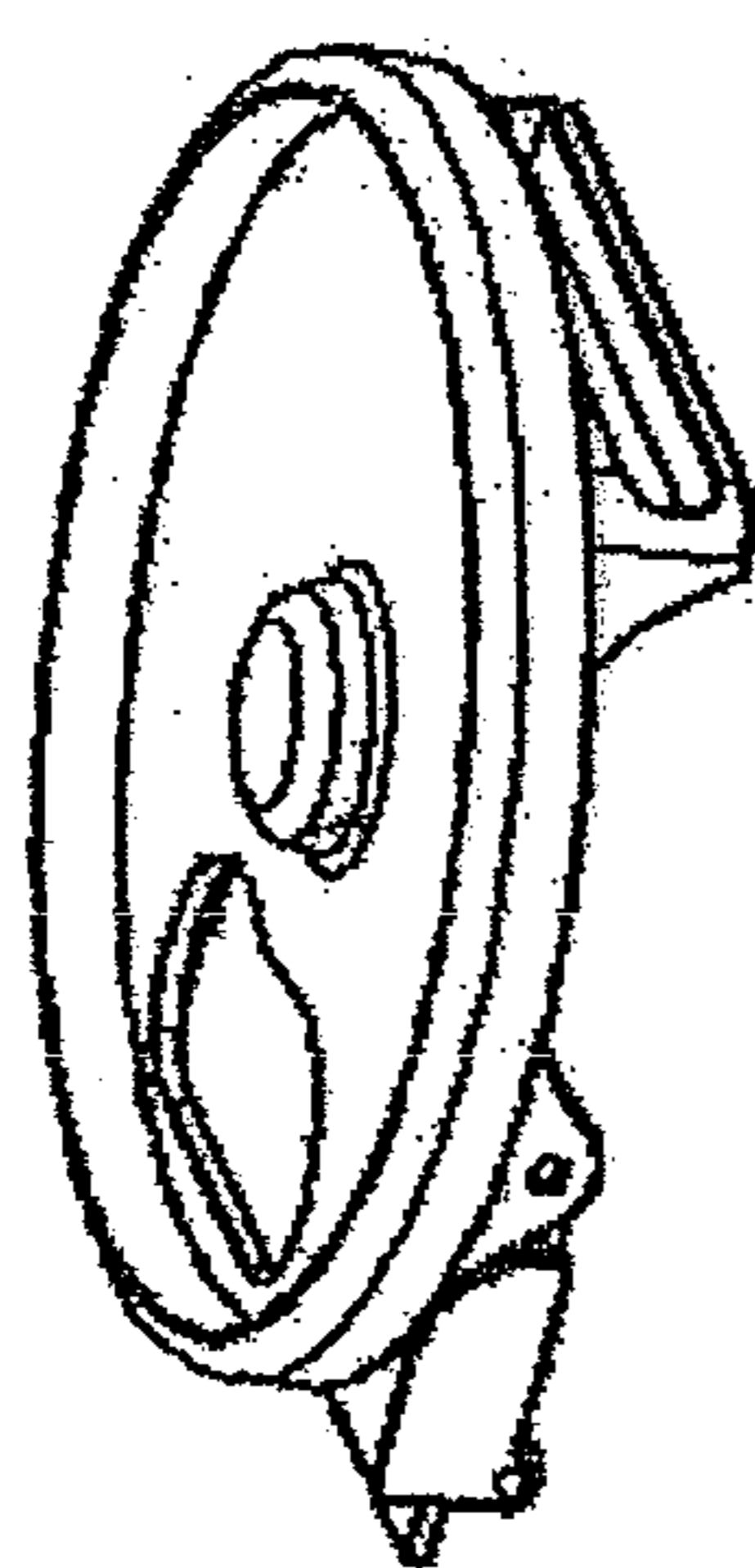

Fig. 23

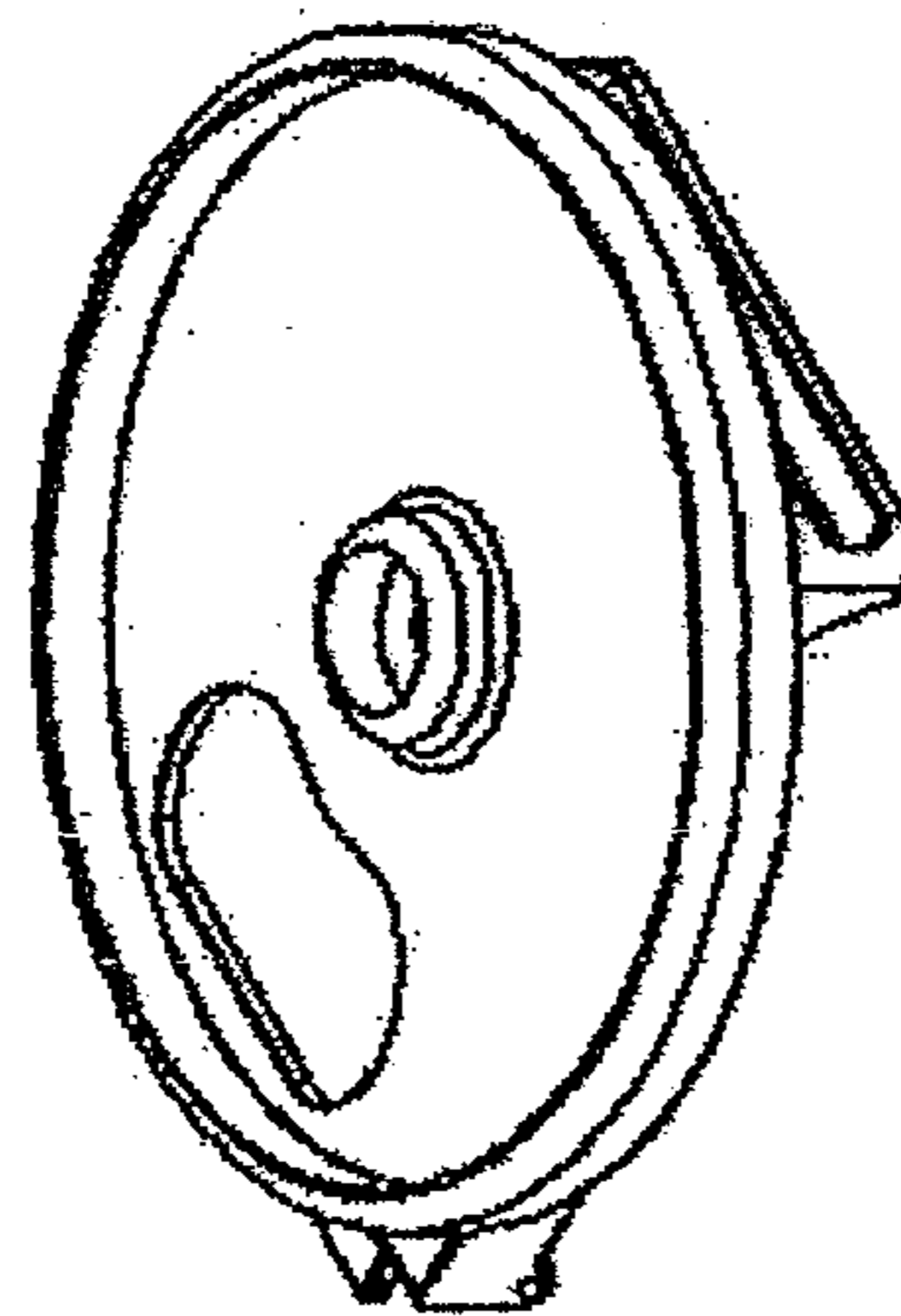

Fig. 24

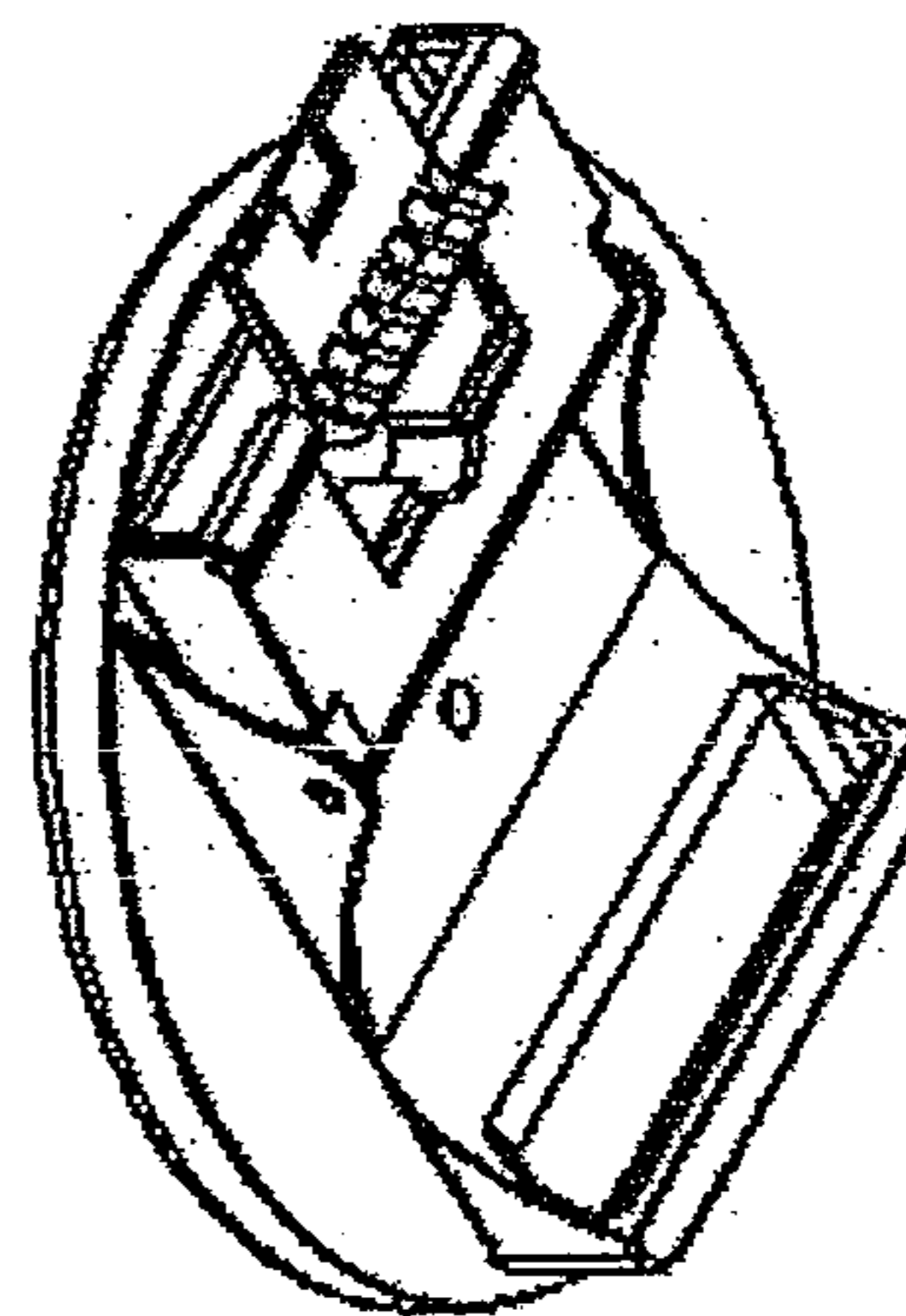

Fig. 25

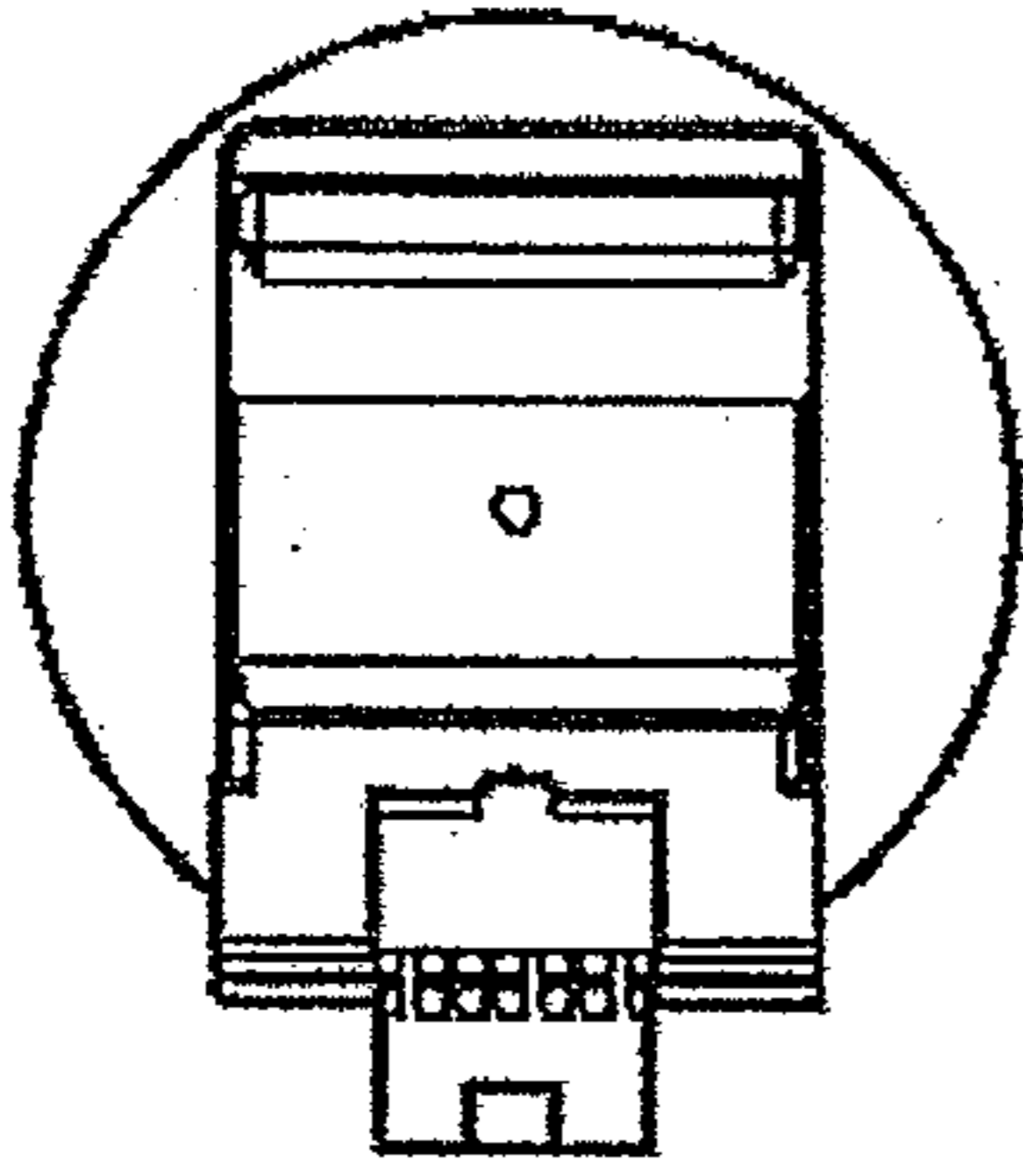

Fig. 26

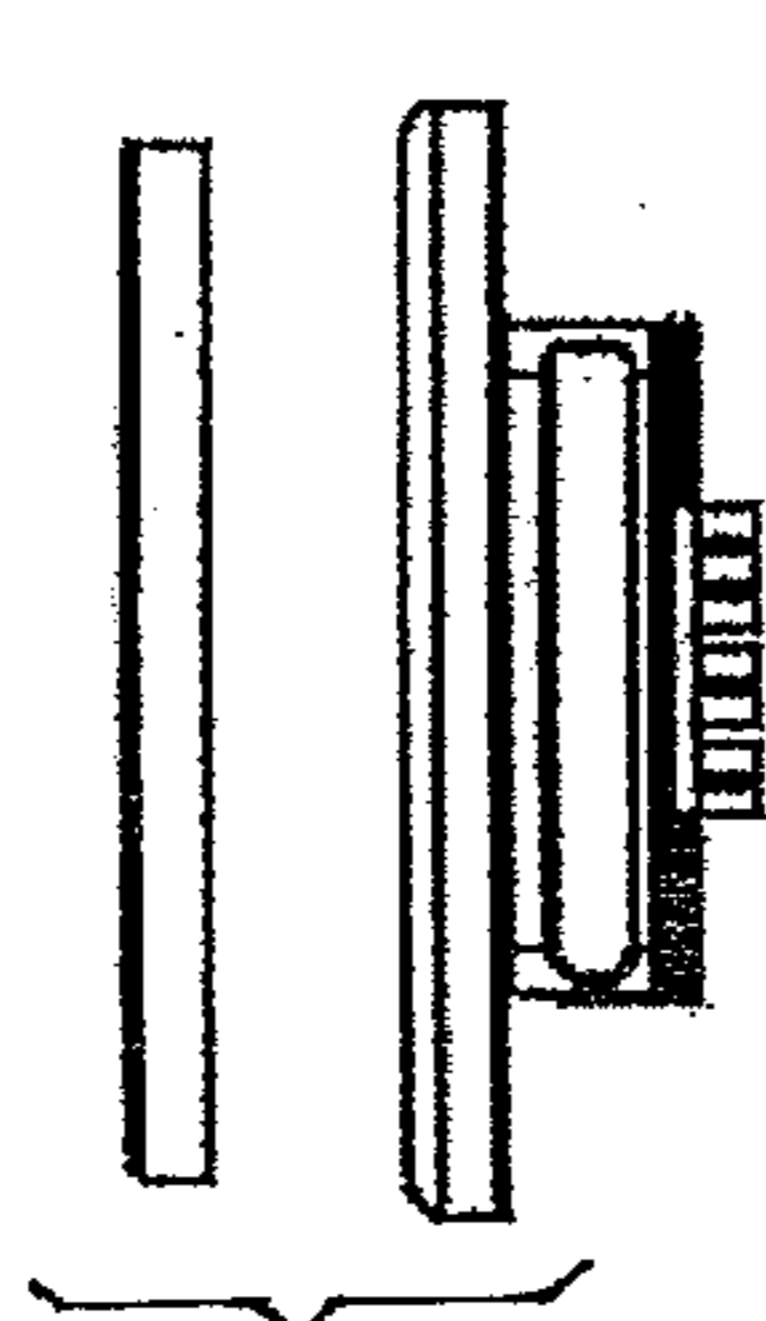

Fig. 27

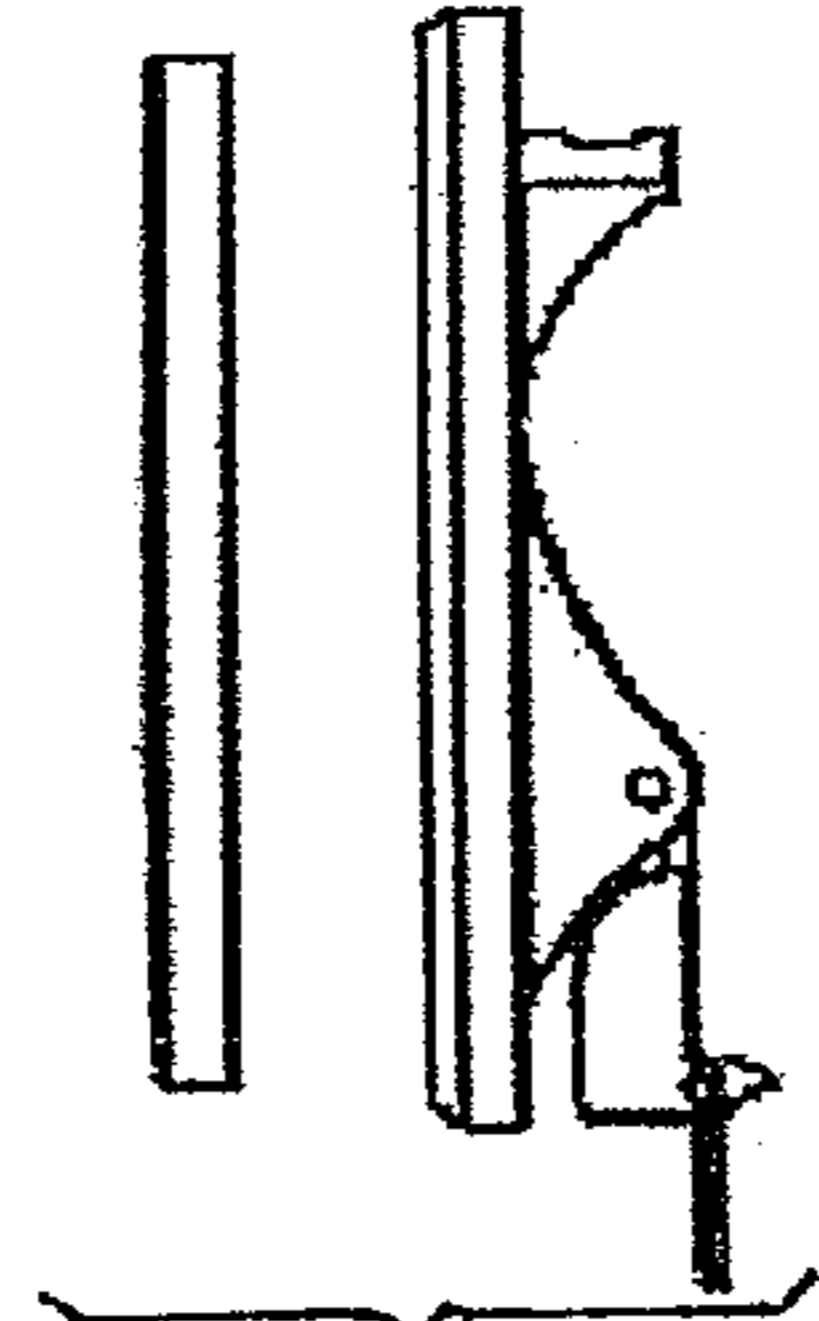

Fig. 28

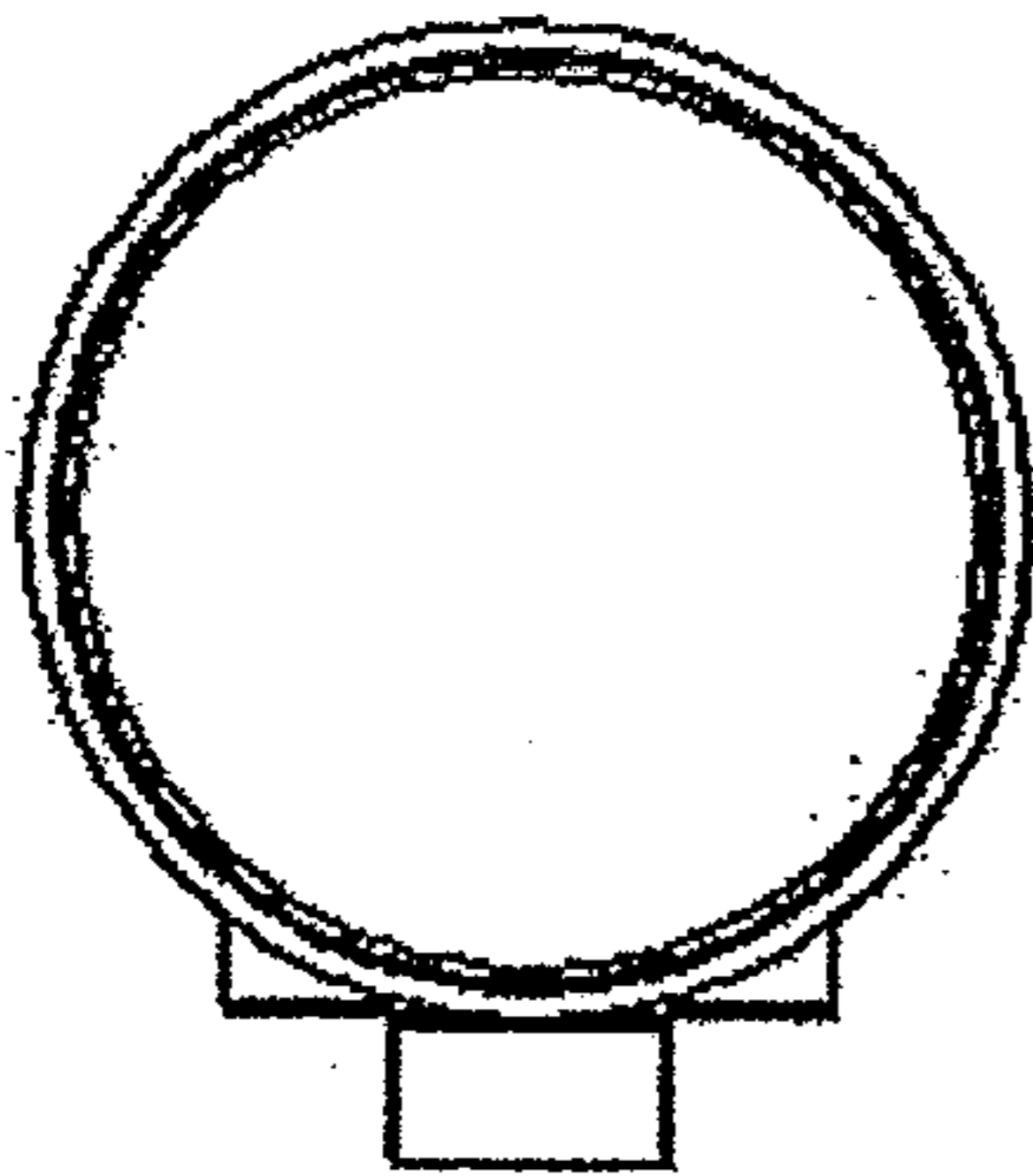

Fig. 29

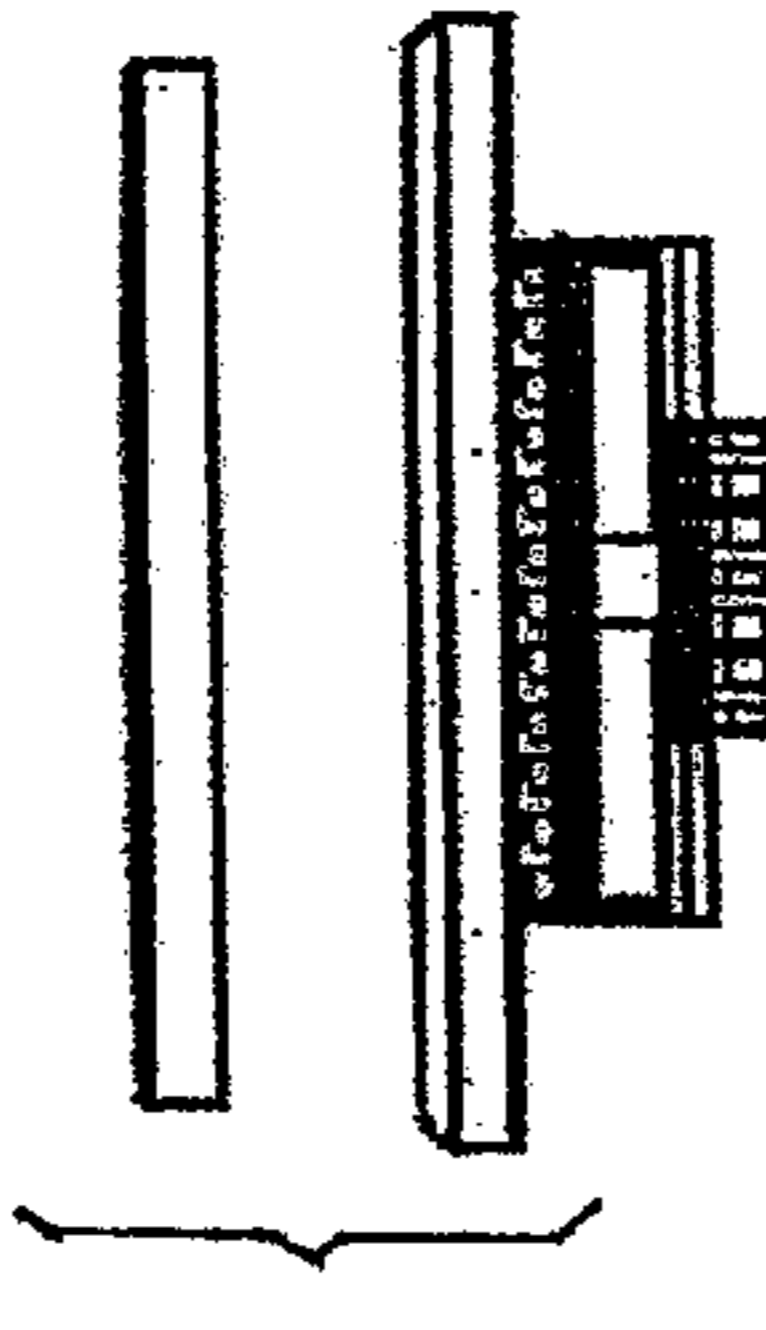

Fig. 30

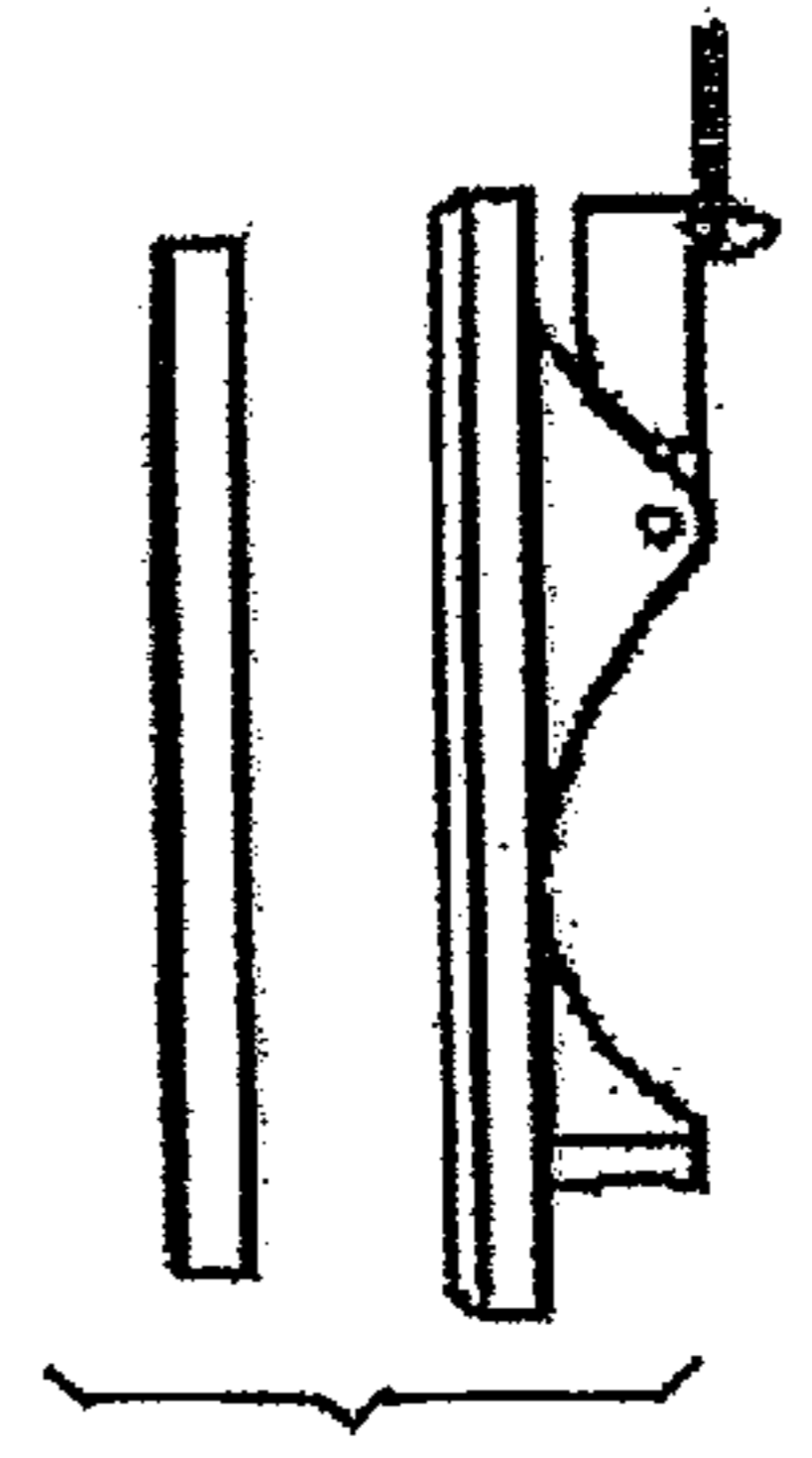

Fig. 31

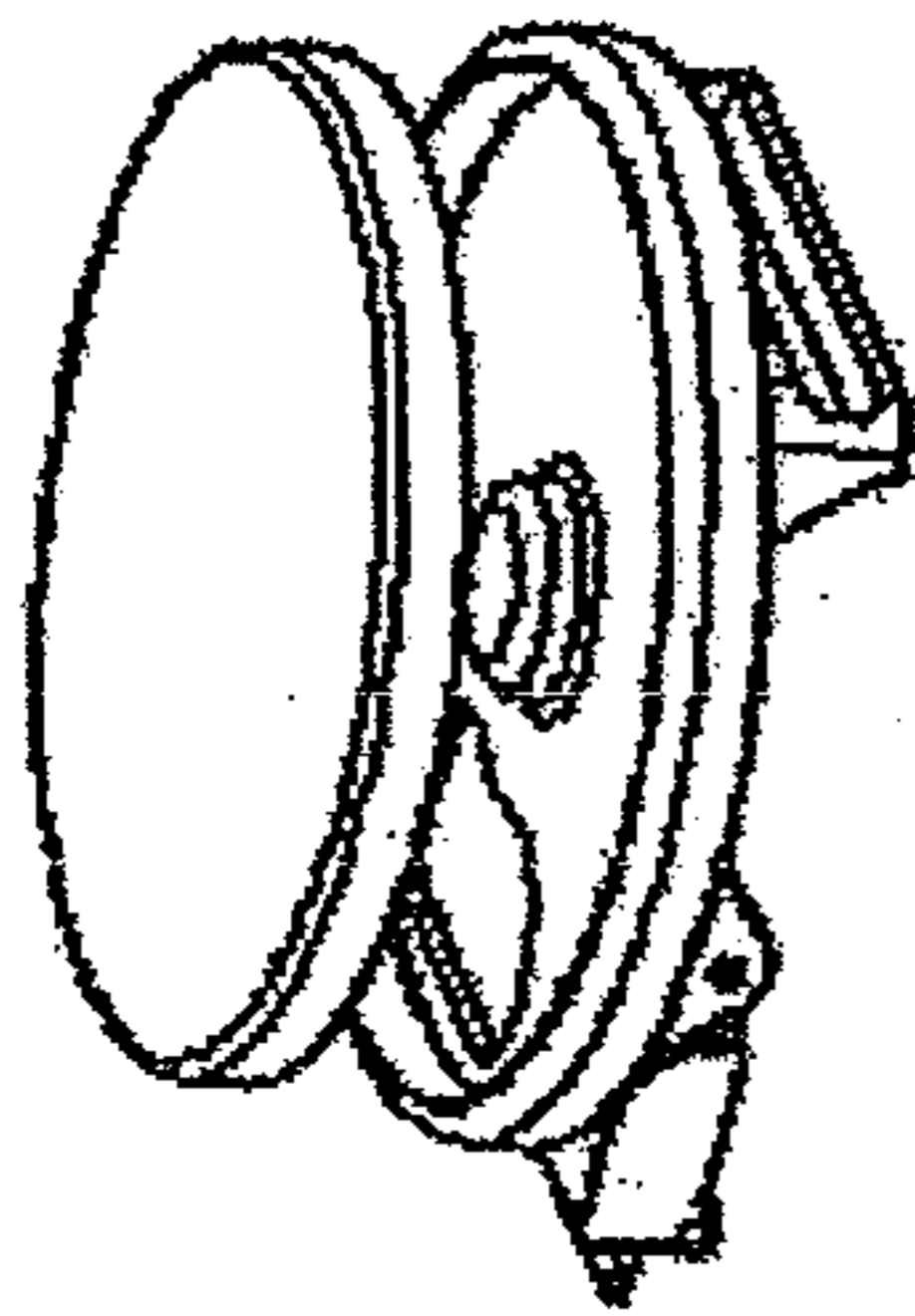

Fig. 32

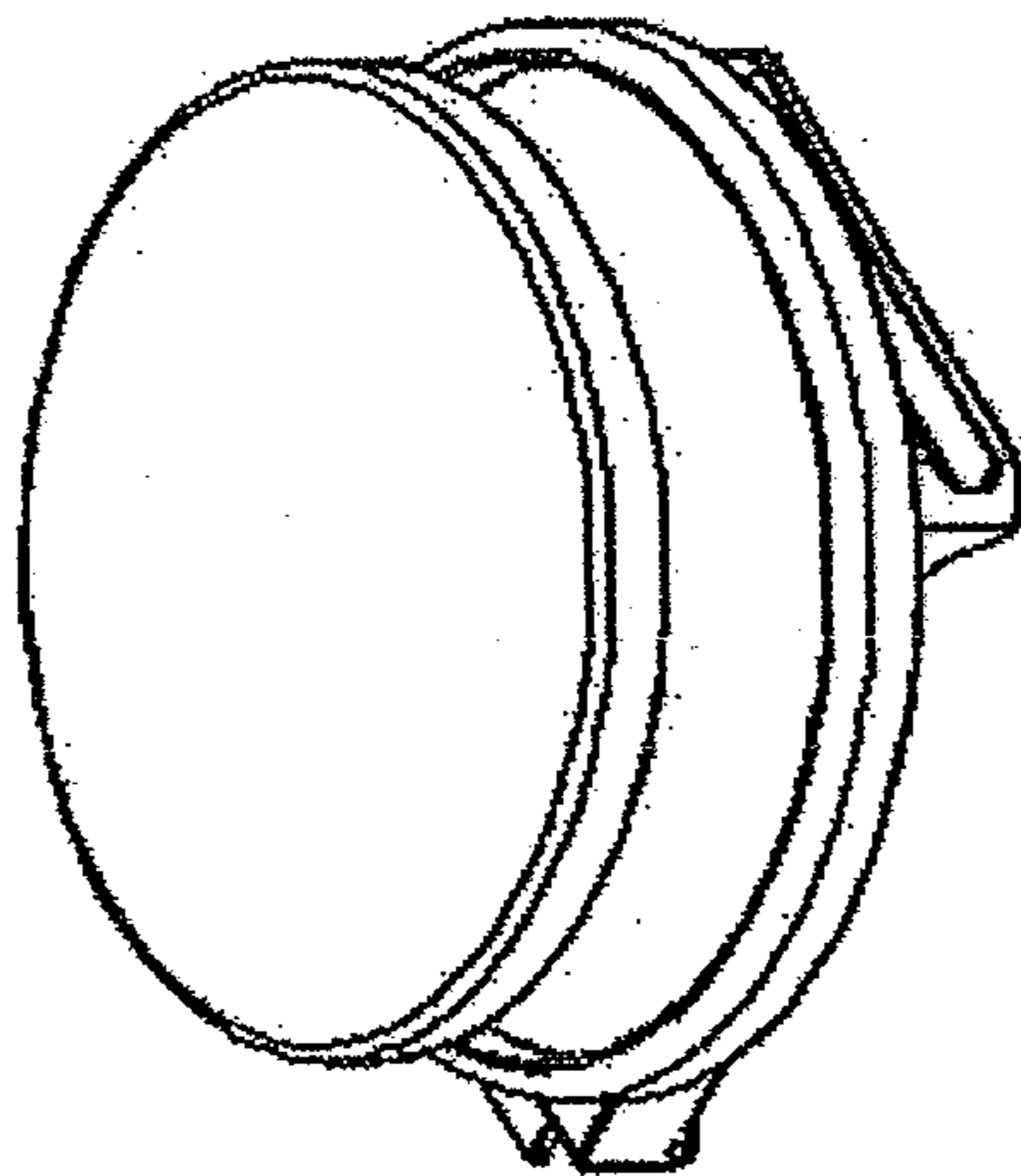

Fig. 33

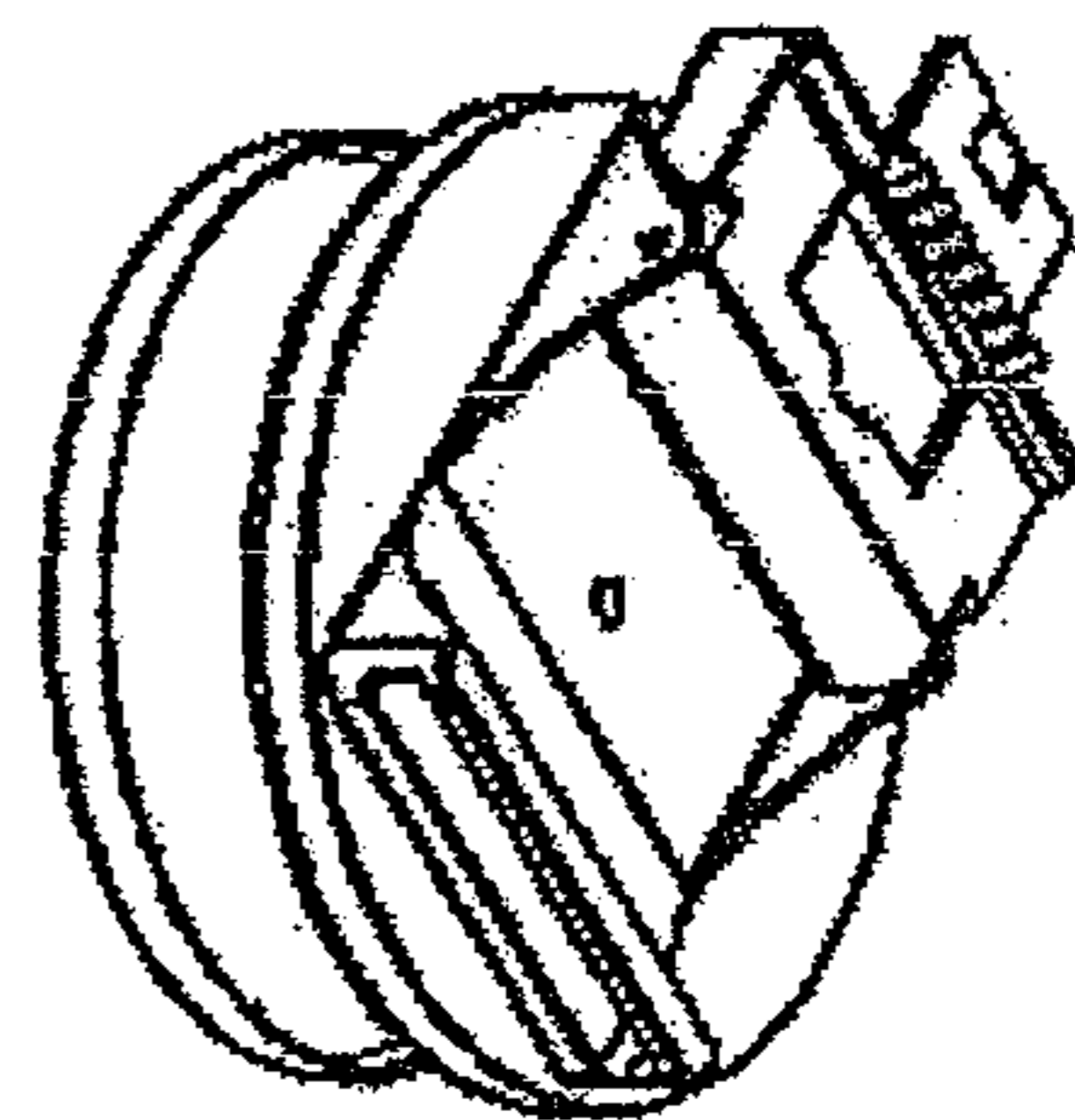

Fig. 34