



US00D632015S

(12) **United States Design Patent**
Lai

(10) **Patent No.:** **US D632,015 S**

(45) **Date of Patent:** **** *Feb. 1, 2011**

(54) **COSMETICS BOX**

D564,707 S * 3/2008 Barresi D28/83

(75) Inventor: **Chin-Chun Lai**, Hsinchu (TW)

* cited by examiner

(73) Assignee: **Chao Ling Chemical Industry Co., Ltd.**, Hsinchu (TW)

Primary Examiner—Jennifer Rivard

(74) *Attorney, Agent, or Firm*—Muncy, Geissler, Olds & Lowe, PLLC

(*) Notice: This patent is subject to a terminal disclaimer.

(57) **CLAIM**

(**) Term: **14 Years**

The ornamental design for a cosmetics box, as shown and described.

(21) Appl. No.: **29/274,238**

DESCRIPTION

(22) Filed: **Apr. 6, 2007**

FIG. 1 is a perspective view of a cosmetics box;

(51) **LOC (9) Cl.** **28-03**

FIG. 2 is a front view thereof;

(52) **U.S. Cl.** **D28/83**

FIG. 3 is a back view thereof;

(58) **Field of Classification Search** D28/73,

FIG. 4 is a left side view thereof;

D28/76–84; 132/286–288, 293–307, 312–318;

FIG. 5 is a right side view thereof;

220/DIG. 26; 206/581, 823

FIG. 6 is a top view thereof;

See application file for complete search history.

FIG. 7 is a bottom view thereof; and,

(56) **References Cited**

FIG. 8 is a perspective view thereof, wherein the cosmetics box is in an opened position with internal container trays in an extended position for illustrative purpose.

U.S. PATENT DOCUMENTS

The broken line showing of the interior of the box is included for the purpose of illustrating portions of the article and forms no part of the claimed design.

D422,120 S * 3/2000 Orsomando D28/83

D465,305 S * 11/2002 Thorpe et al. D28/83

D472,676 S * 4/2003 Lai D28/79

D478,192 S * 8/2003 Lai D28/83

D479,895 S * 9/2003 Lai D28/83

D554,804 S * 11/2007 Bernard D28/83

1 Claim, 8 Drawing Sheets

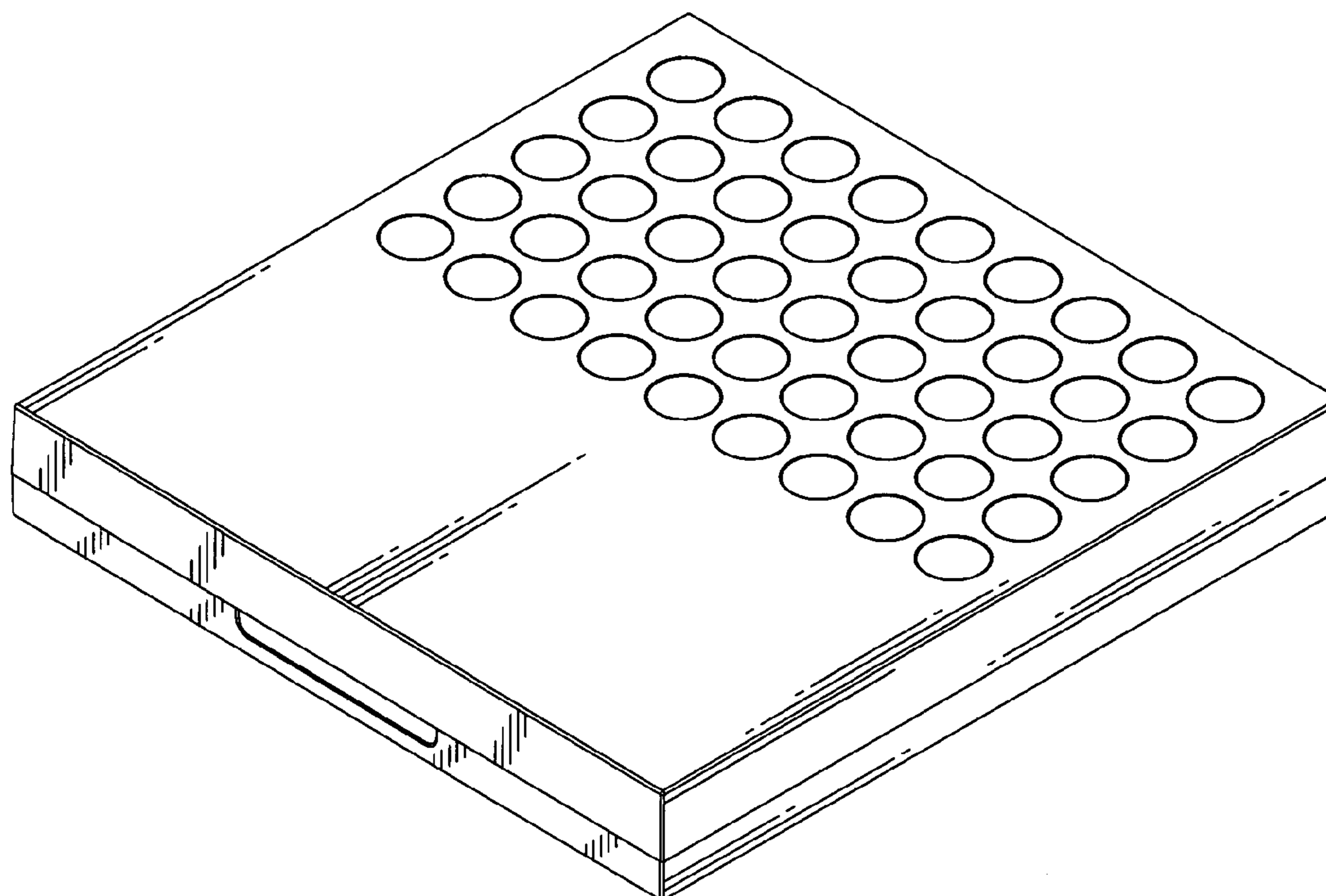

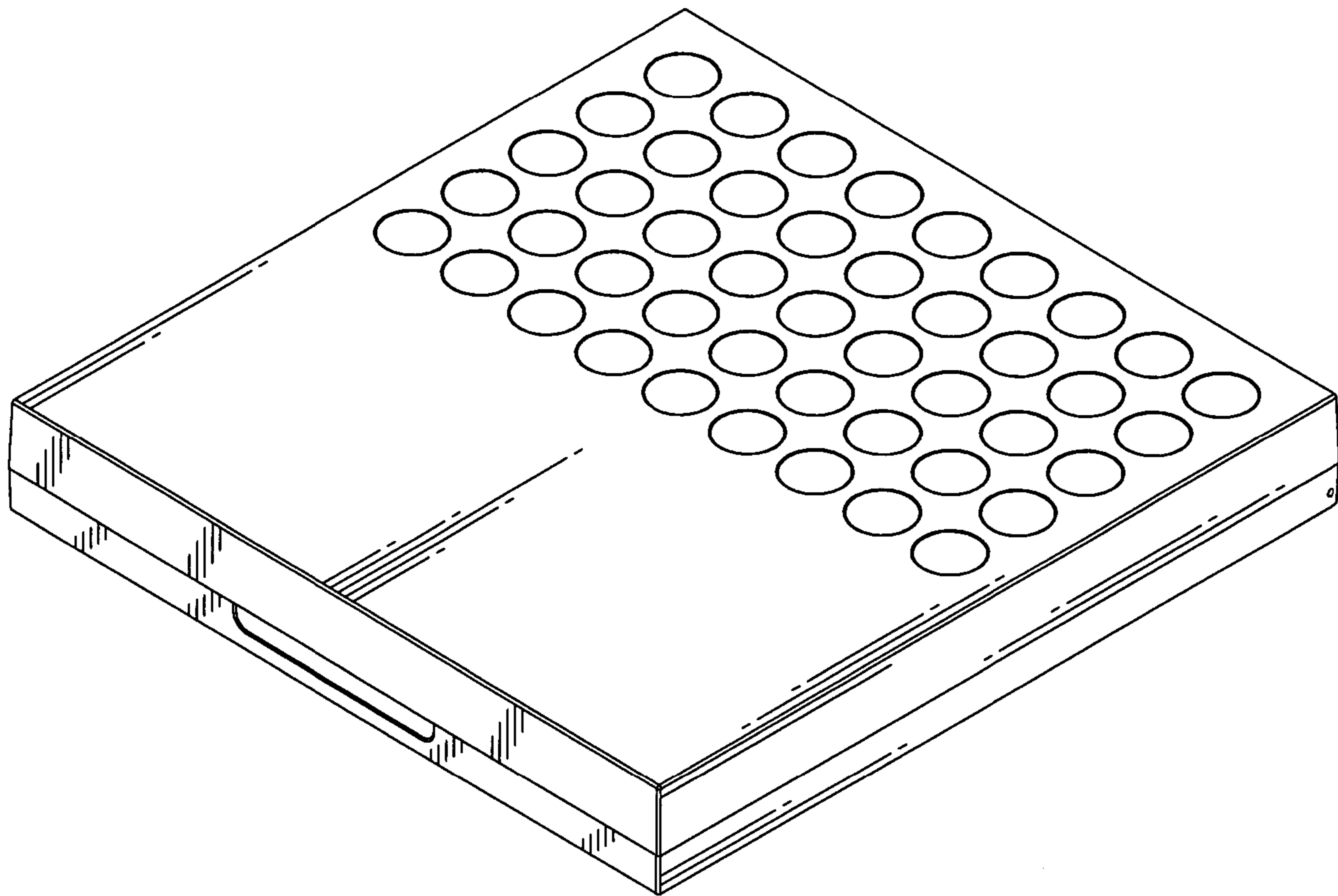

FIG. 1

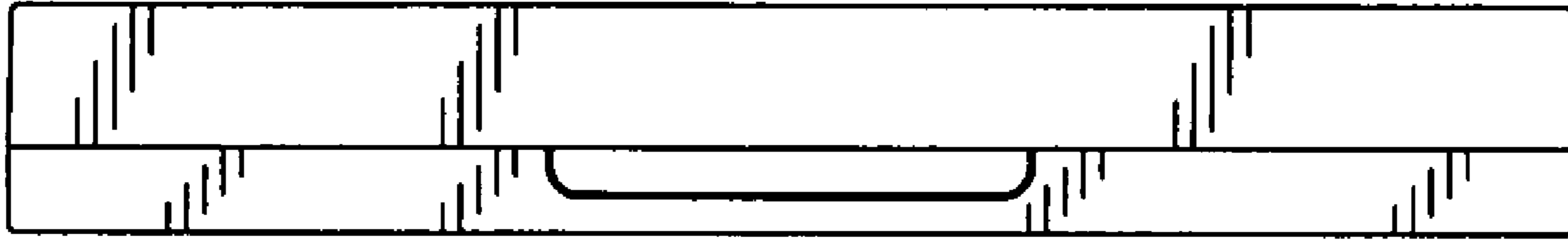

FIG. 2

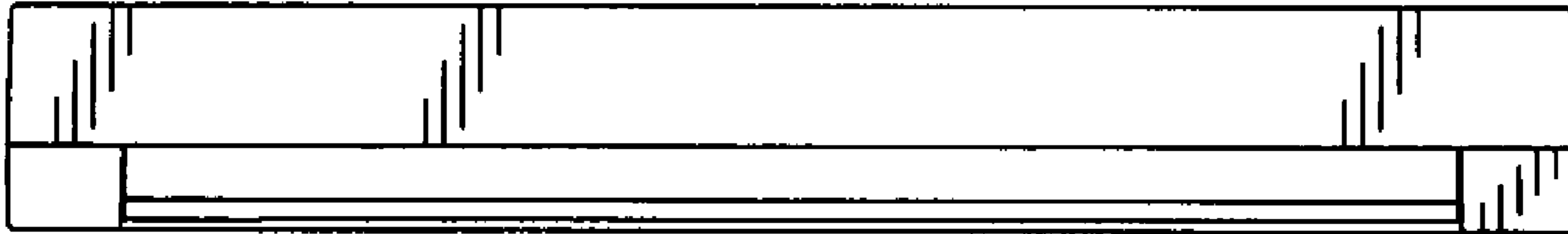

FIG. 3

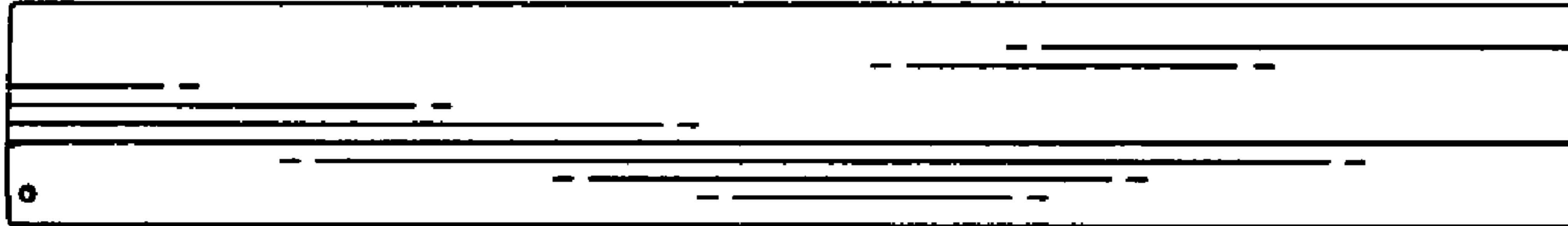

FIG. 4

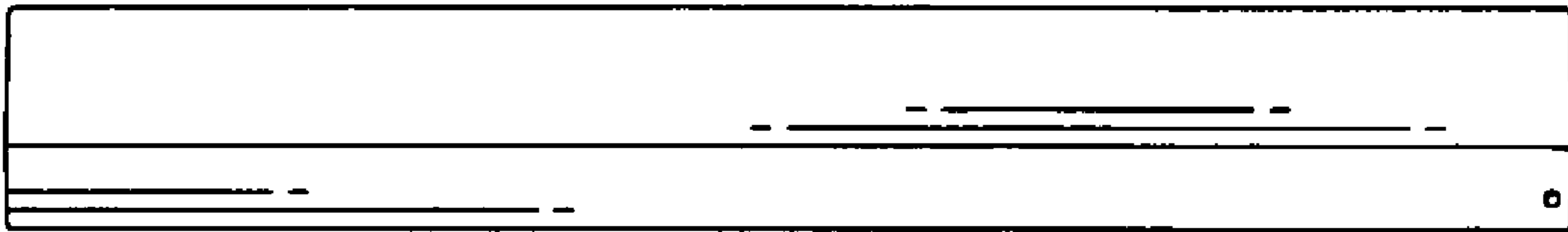

FIG. 5

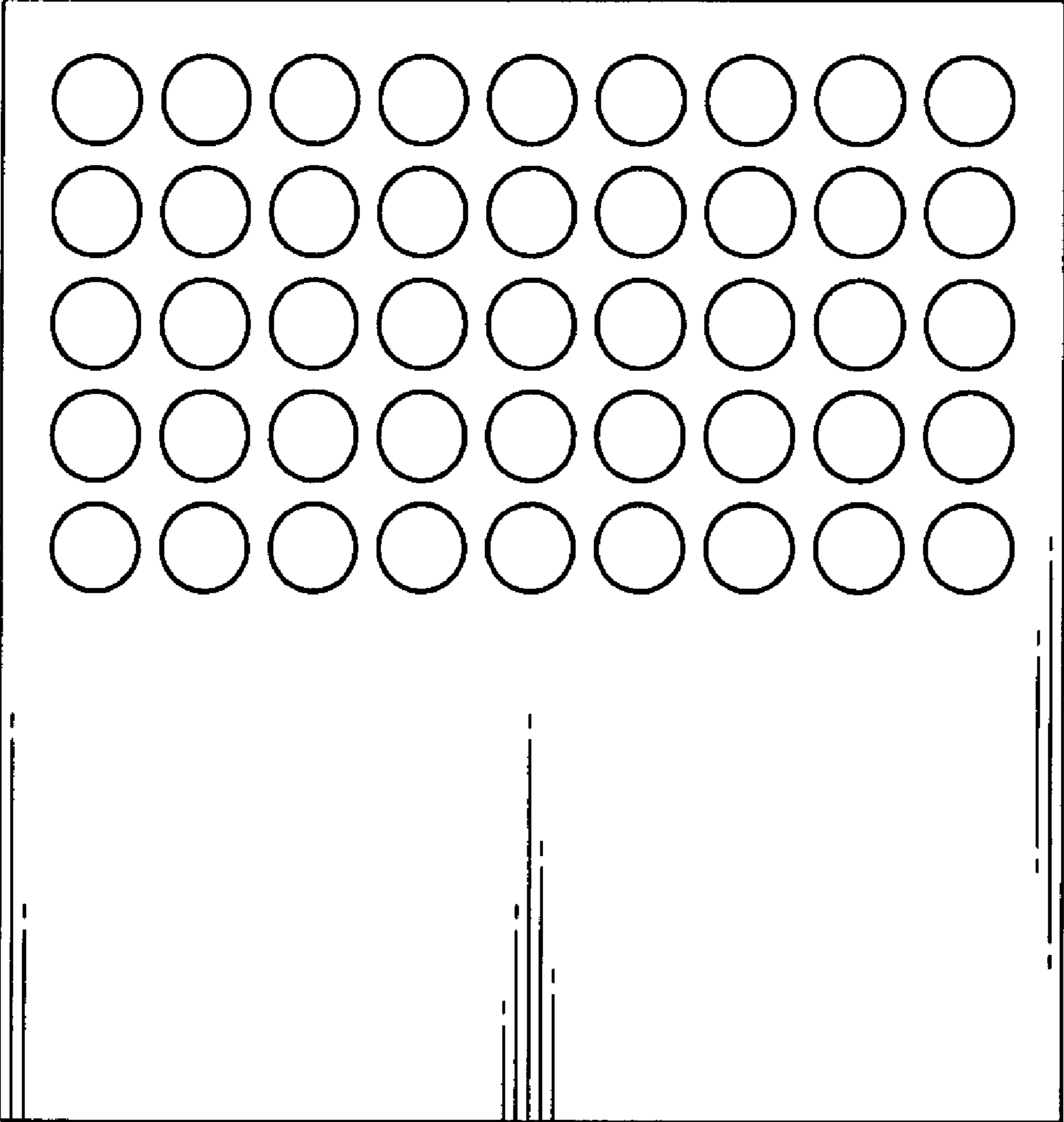

FIG. 6

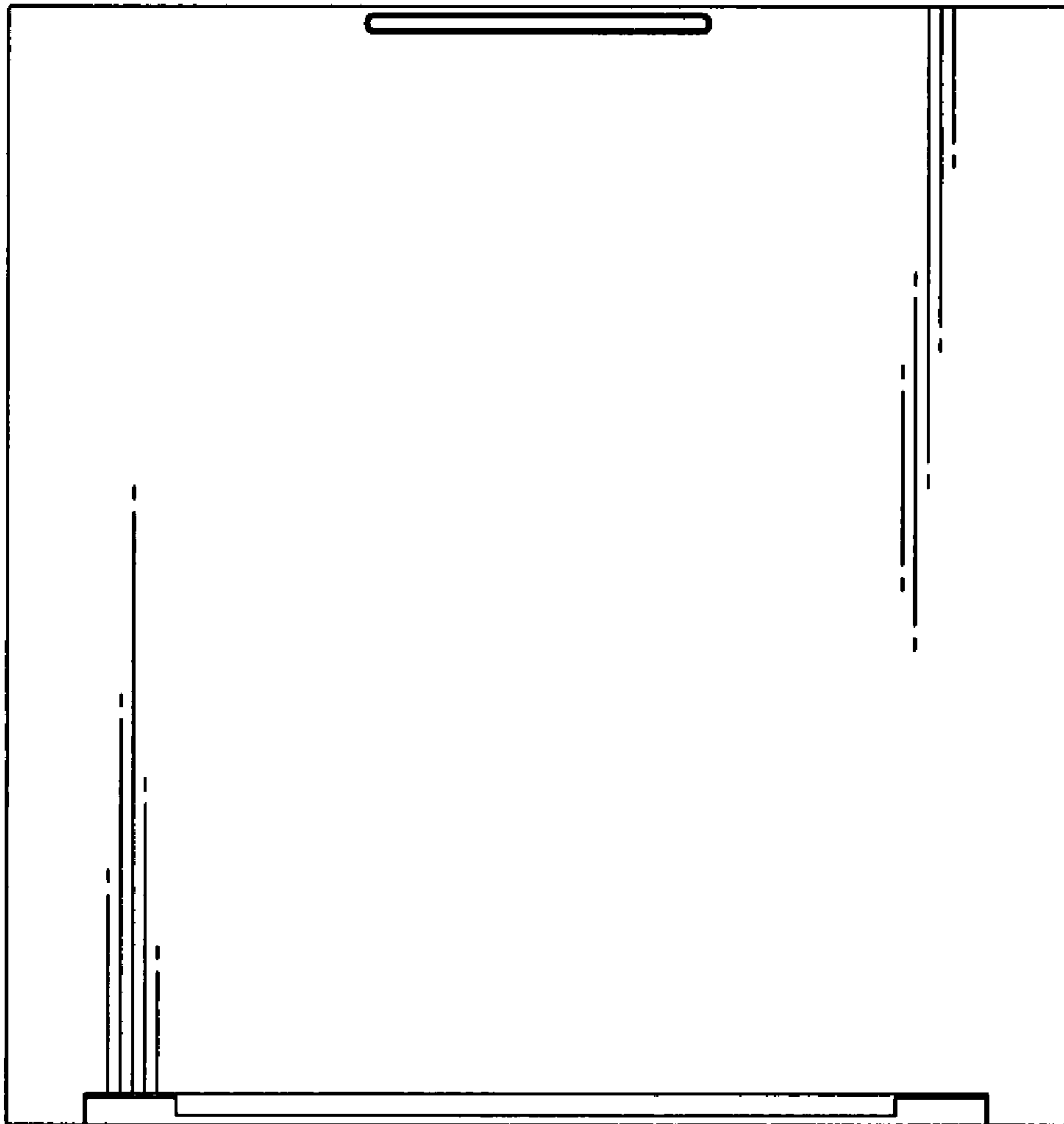

FIG. 7

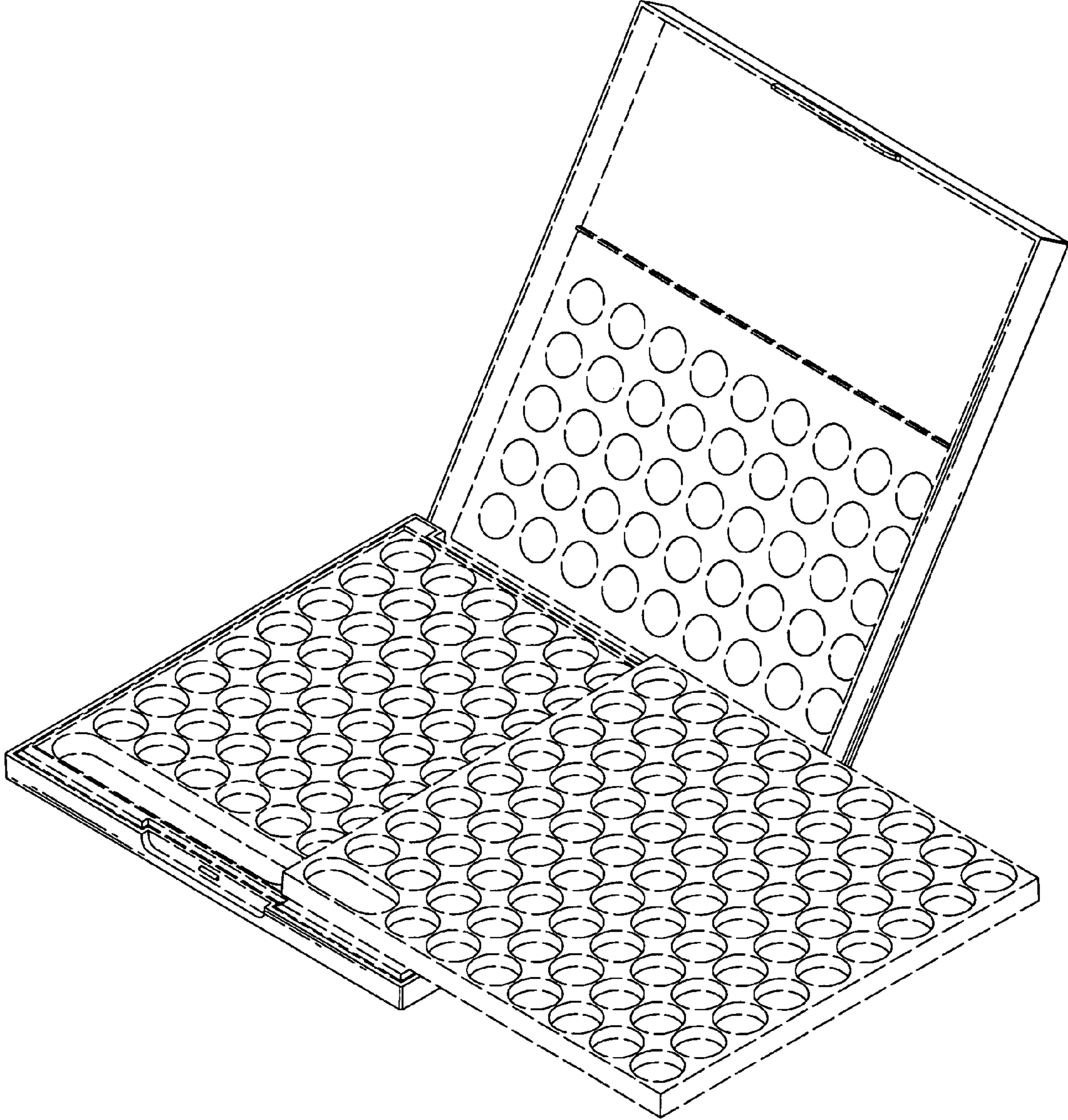

FIG. 8