



US00D631985S

(12) **United States Design Patent**  
**Waters et al.**

(10) **Patent No.:** **US D631,985 S**  
(45) **Date of Patent:** **\*\* Feb. 1, 2011**

(54) **CEILING PANEL**

**DESCRIPTION**

- (75) Inventors: **James R. Waters**, Lancaster, PA (US);  
**Nathan J. Baxter**, Lancaster, PA (US)
- (73) Assignee: **AWI Licensing Company**, Wilmington, DE (US)
- (\*\*) Term: **14 Years**
- (21) Appl. No.: **29/332,555**
- (22) Filed: **Feb. 19, 2009**
- (51) **LOC (9) Cl.** ..... **25-01**
- (52) **U.S. Cl.** ..... **D25/138**
- (58) **Field of Classification Search** ..... D25/138-164,  
D25/58; 52/309.2, 309.13, 311.1, 311.2,  
52/314, 316, 384, 387, 474-475.1, 479, 506.06,  
52/506.08, 588.1, 518, 546, 554-557, 559;  
428/47-49, 77, 141-143, 161-163, 194  
See application file for complete search history.

(56) **References Cited**

**U.S. PATENT DOCUMENTS**

|           |     |         |                |       |         |
|-----------|-----|---------|----------------|-------|---------|
| 2,935,152 | A * | 5/1960  | Maccaferri     | ..... | 52/316  |
| D474,550  | S * | 5/2003  | Wendt          | ..... | D25/138 |
| D487,521  | S * | 3/2004  | Link           | ..... | D25/138 |
| D491,285  | S * | 6/2004  | Mock           | ..... | D25/138 |
| D511,390  | S * | 11/2005 | Schubert       | ..... | D25/138 |
| D520,148  | S * | 5/2006  | Kendall et al. | ..... | D25/138 |
| D576,315  | S * | 9/2008  | Mock et al.    | ..... | D25/138 |
| D603,066  | S * | 10/2009 | Warren et al.  | ..... | D25/138 |
| D608,473  | S * | 1/2010  | Larson         | ..... | D25/138 |
| D619,271  | S * | 7/2010  | Ezra           | ..... | D25/138 |

\* cited by examiner

*Primary Examiner*—Catherine R Oliver

(57) **CLAIM**

The ornamental design for a ceiling panel, as shown and described.

FIG. 1 is a top plan view of a first embodiment of a ceiling panel showing our new design;

FIG. 2 is a perspective view thereof;

FIG. 3 is an edge view thereof;

FIG. 4 is a front elevation view, with the rear elevation view being a mirror image thereof;

FIG. 5 is a view of the ceiling panel shown in FIGS. 1-4. The broken lines showing suspension hardware and like ceiling panels for the purpose of illustrating the environment only and forming no part of the claimed design;

FIG. 6 is a view similar to FIG. 1. The broken lines showing suspension hardware and like ceiling panels for the purpose of illustrating the environment only and forming no part of the claimed design;

FIG. 7 is a view of the ceiling panel shown in FIGS. 1-4. The broken lines showing suspension hardware and the like ceiling panels for the purpose of illustrating the environment only and forming no part of the claimed design. The broken lines showing an alternative parquet ceiling panel pattern;

FIG. 8 is a view similar to FIG. 1. The broken lines showing suspension hardware and like ceiling panels for the purpose of illustrating the environment only and forming no part of the claimed design. The broken lines showing an alternative parquet ceiling panel pattern;

FIG. 9 is a view of the ceiling panel shown in FIGS. 1-4. The broken lines showing suspension hardware and like ceiling panels for the purpose of illustrating the environment only and forming no part of the claimed design. The broken lines showing an alternating row ceiling panel pattern;

FIG. 10 is a view similar to FIG. 1. The broken lines showing suspension hardware and like ceiling panels for the purpose of illustrating environment only and forming no part of the claimed design. The broken lines showing an alternating row ceiling panel pattern;

FIG. 11 is a view of the ceiling panel shown in FIGS. 1-4. The broken lines showing suspension hardware and like ceiling panels for the purpose of illustrating the environment only and not forming part of the claimed design. The broken lines

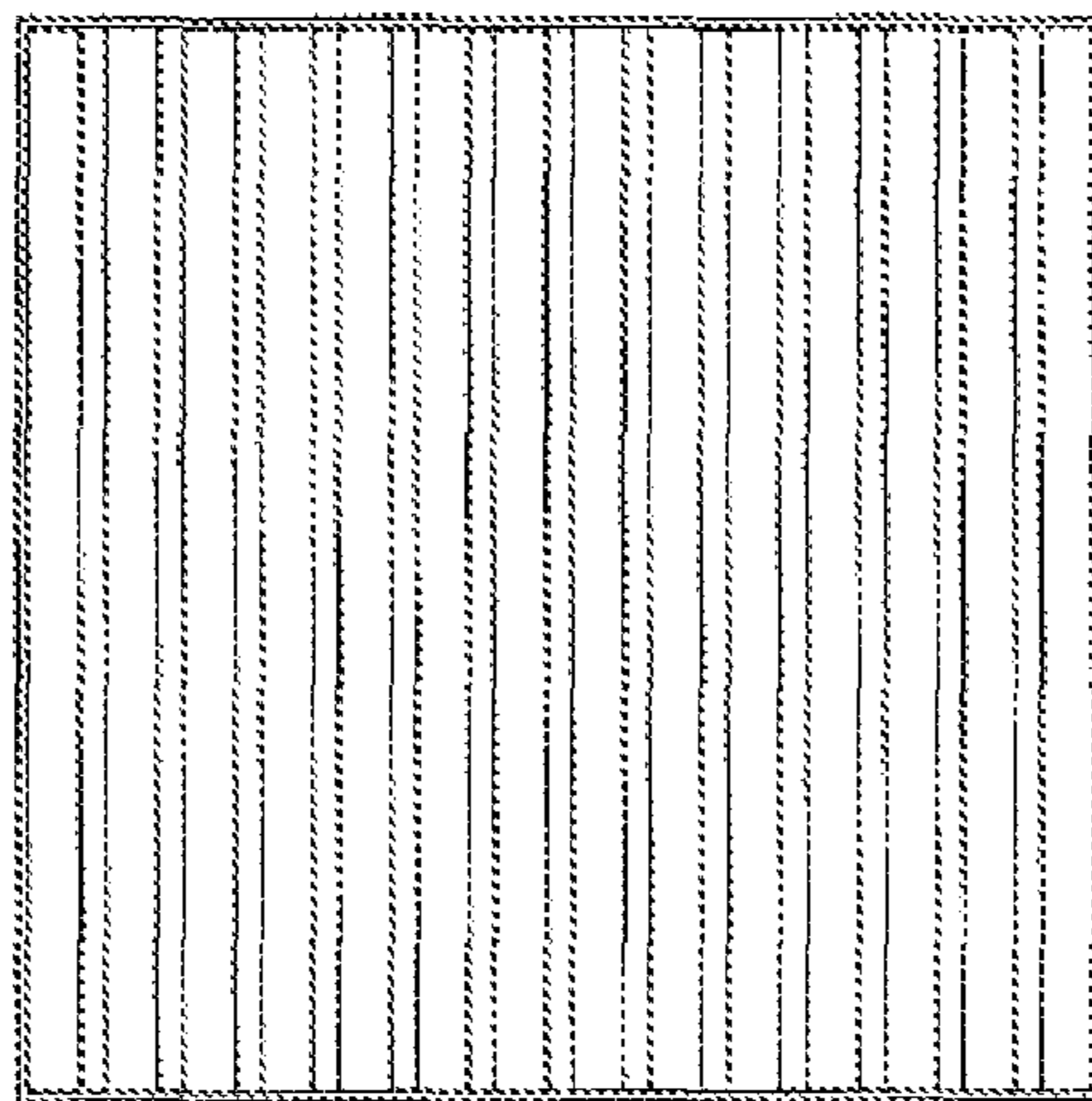

showing an alternating row ceiling panel pattern similar to FIG. 9 where each adjacent panel within a row is rotated 180 degrees;

FIG. 12 is a view similar to FIG. 1. The broken lines showing suspension hardware and like ceiling panels for the purpose of illustrating the environment only and forming no part of the claimed design. The broken lines showing the alternating row ceiling panel pattern of FIG. 11;

FIG. 13 is a top view of a ceiling panel showing a second embodiment of our new design;

FIG. 14 is a perspective view thereof;

FIG. 15 is an edge view thereof;

FIG. 16 is a front elevation view, with the rear elevation view being a mirror image thereof;

FIG. 17 is a view of the ceiling panel shown in FIGS. 13-16. The broken lines showing suspension hardware and like ceiling panels for the purpose of illustrating the environment only and forming no part of the claimed design;

FIG. 18 is a view similar to FIG. 13. The broken lines showing suspension hardware and like ceiling panels for the purpose of illustrating the environment only and forming no part of the claimed design;

FIG. 19 is a view of the ceiling panel shown in FIGS. 13-16. The broken lines showing suspension hardware and like ceiling panels for the purpose of illustrating the environment only and forming no part of the claimed design. The broken lines showing an alternative ceiling panel pattern;

FIG. 20 is a view similar to FIG. 13. The broken lines showing suspension hardware and like ceiling panels for the purpose of illustrating the environment only and forming no part of the claimed design. The broken lines showing an alternative parquet ceiling panel pattern;

FIG. 21 is a view of the ceiling panel shown in FIGS. 13-16. The broken lines showing suspension hardware and like ceiling panels for the purpose of illustrating the environment only and forming no part of the claimed design. The broken lines showing an alternating row ceiling panel pattern;

FIG. 22 is a view similar to FIG. 13. The broken lines showing suspension hardware and like ceiling panels for the purpose of illustrating the environment only and forming no part of the claimed design. The broken lines showing an alternating row and ceiling panel pattern;

FIG. 23 is a view of the ceiling panel shown in FIGS. 13-16. The broken lines showing suspension hardware and like ceiling panels for the purpose of illustrating the environment only and forming no part of the claimed design. The broken lines showing an alternating row ceiling panel pattern similar to FIG. 21 where each adjacent panel within a row is rotated 180 degrees; and,

FIG. 24 is a view similar to FIG. 13. The broken lines showing suspension hardware and like ceiling panels for the purpose of illustrating the environment only and forming no part of the claimed design. The broken lines showing the alternating row ceiling panel pattern of FIG. 23.

**1 Claim, 10 Drawing Sheets**

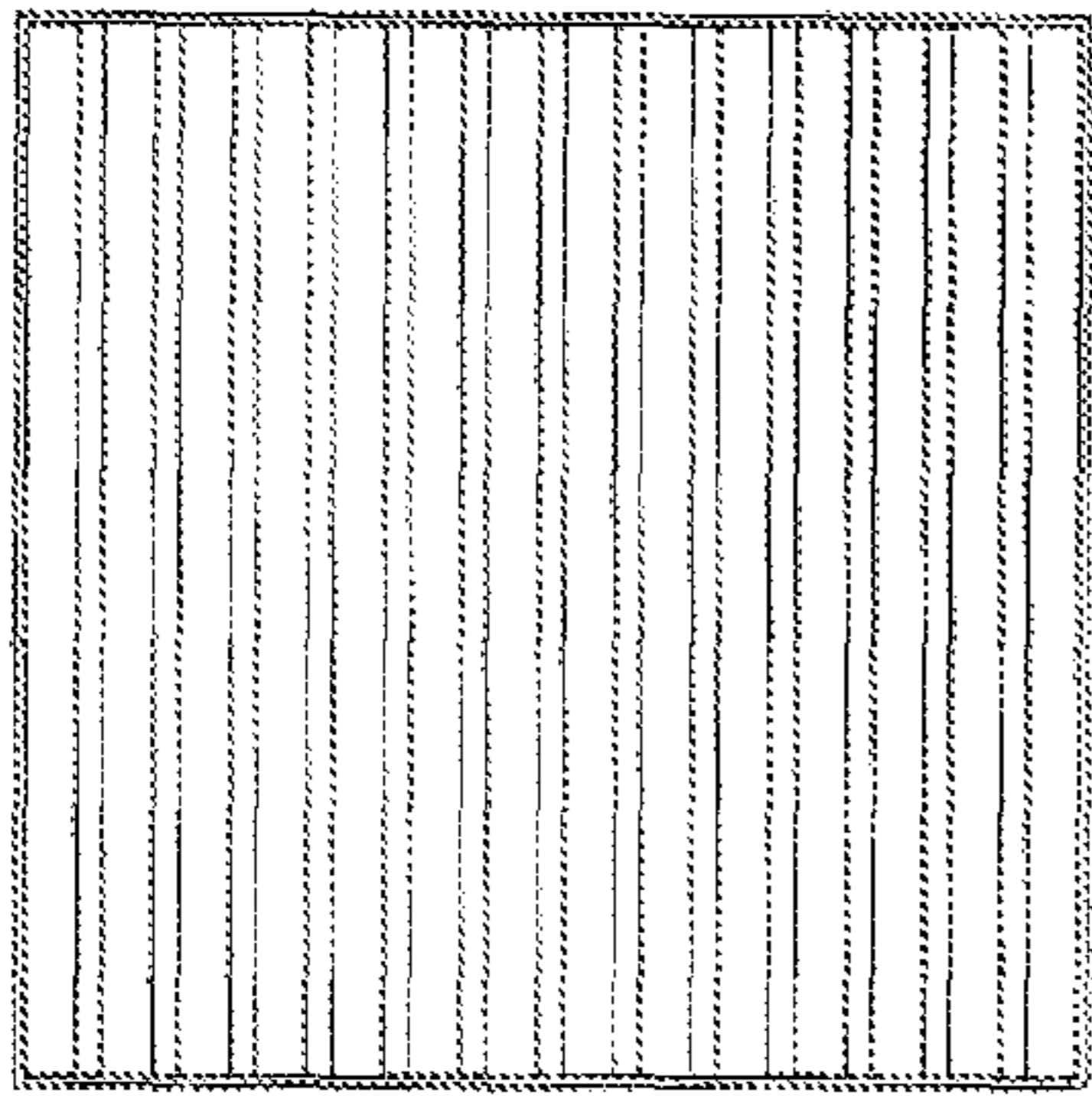

Fig. 1

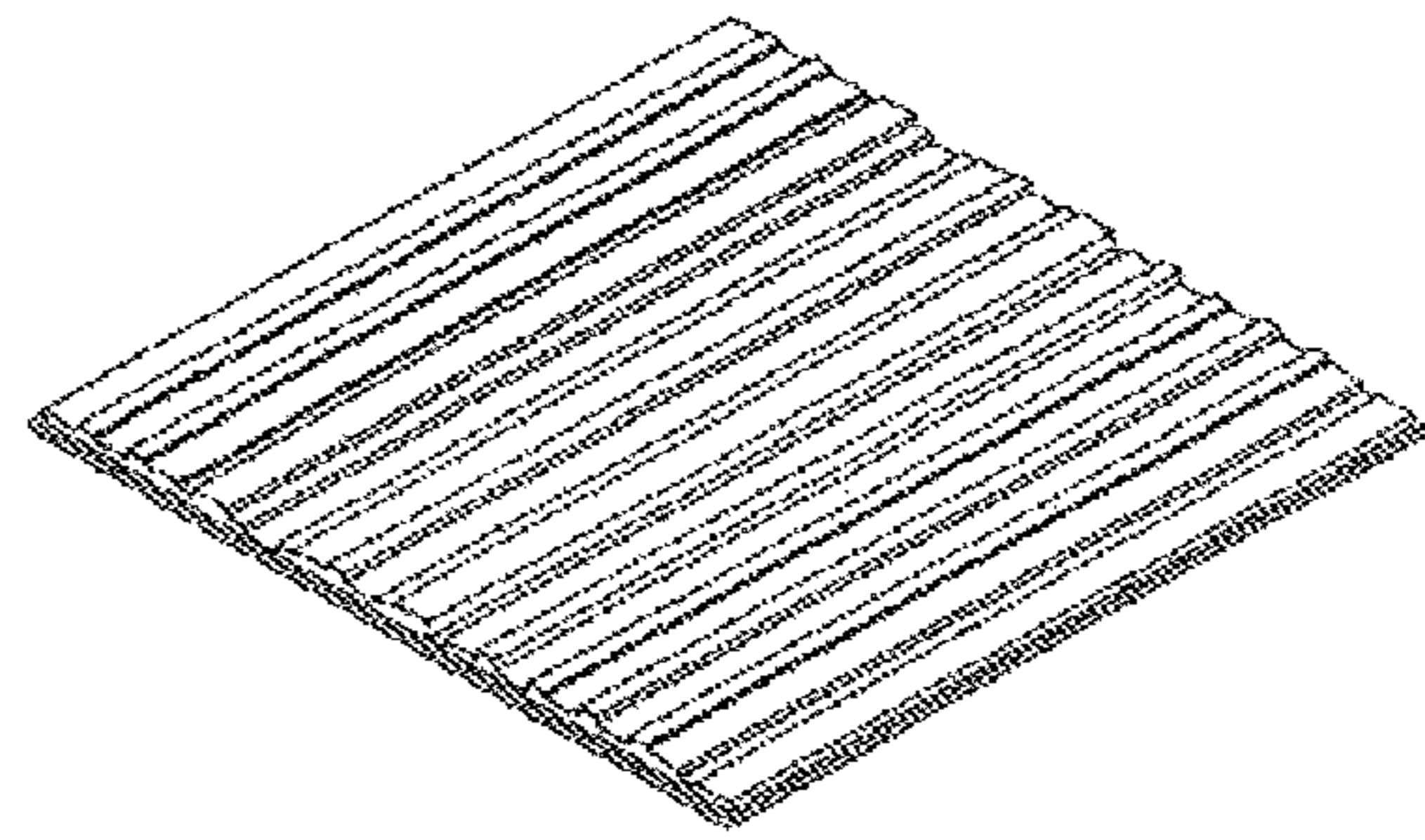

Fig. 2

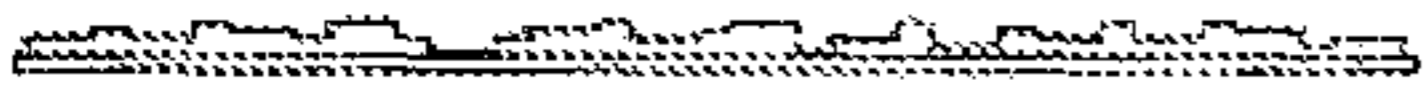

Fig. 3



Fig. 4

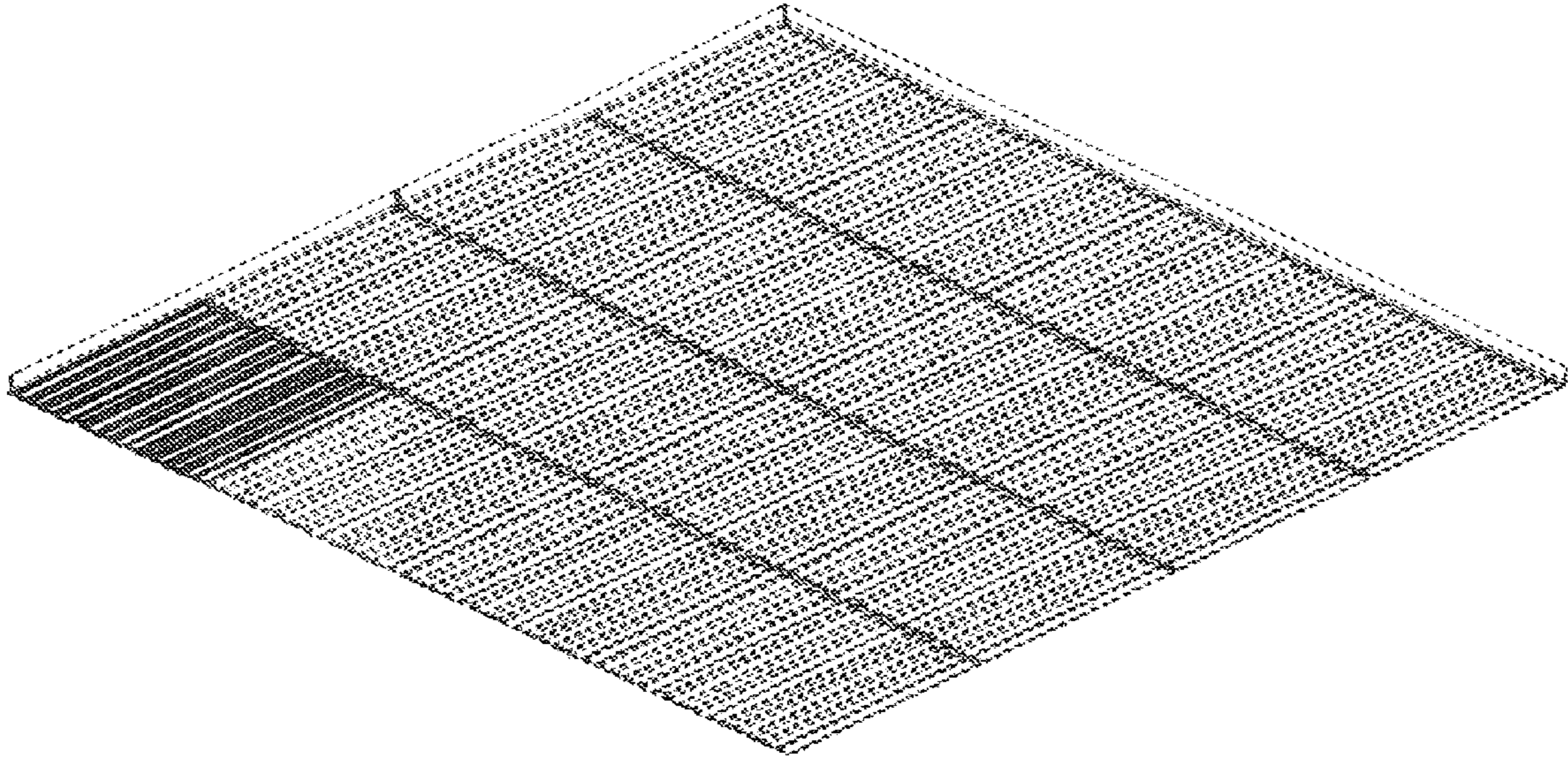

Fig. 5

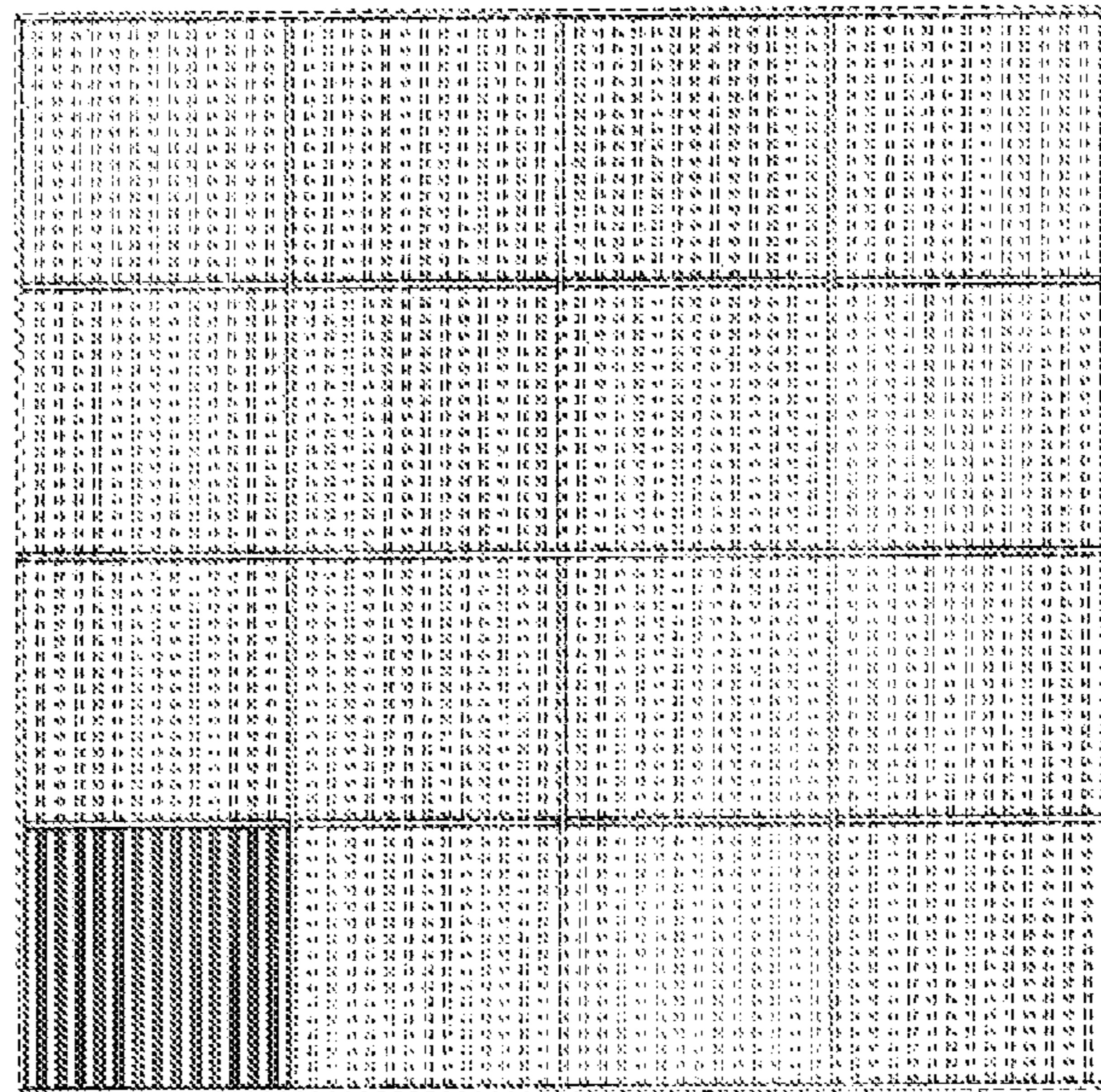

Fig. 6

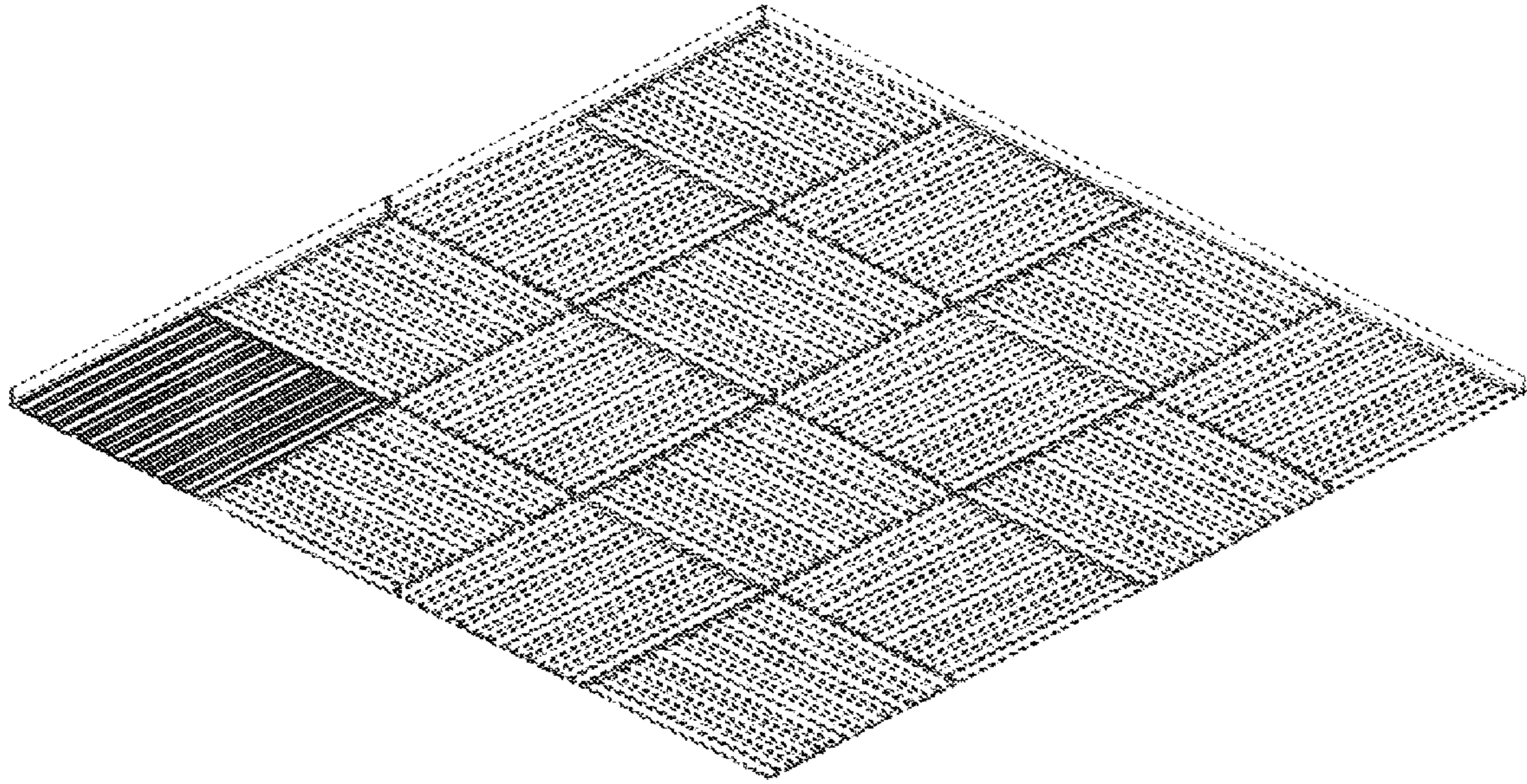

Fig. 7

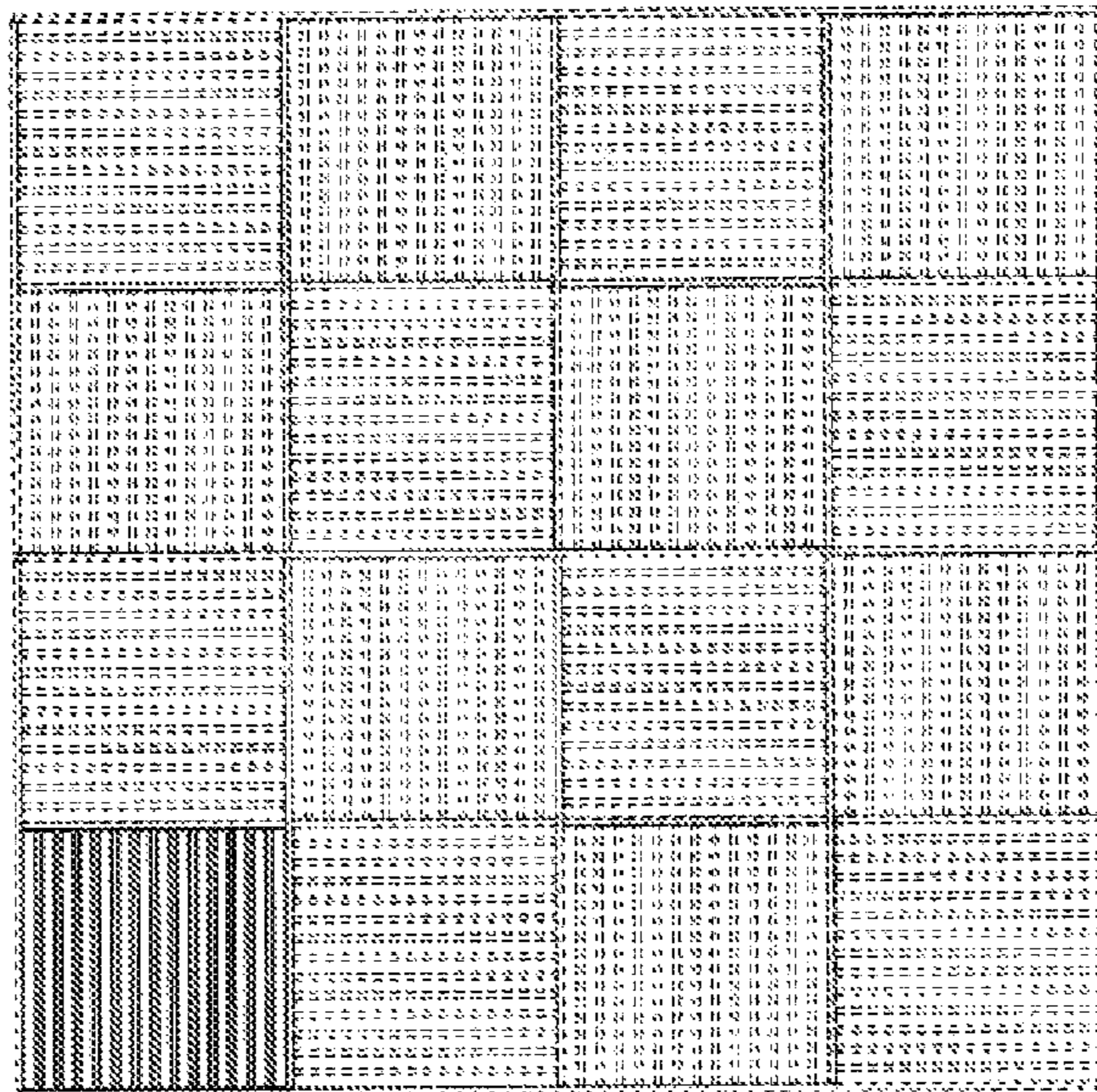

Fig. 8

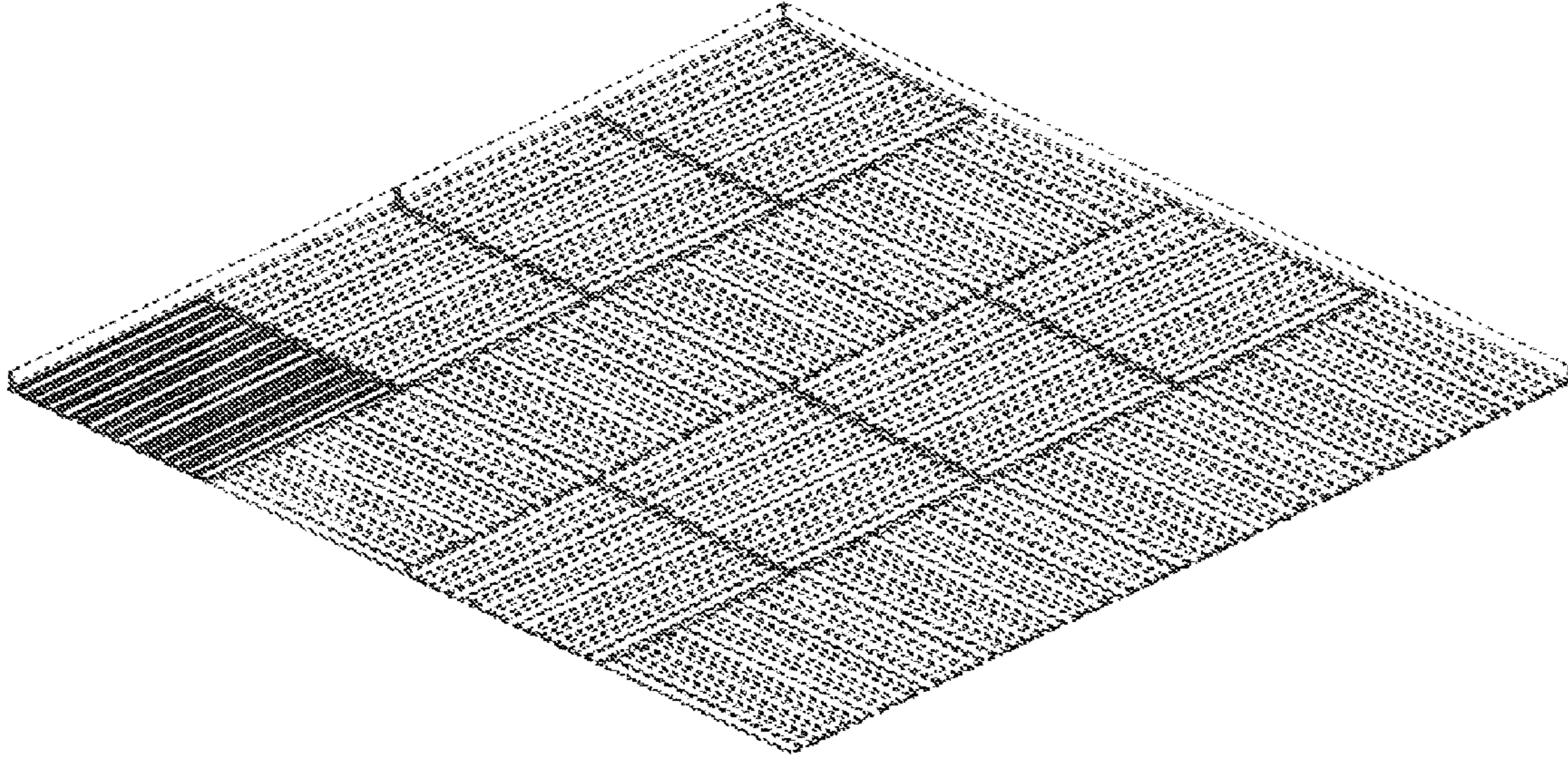

Fig. 9

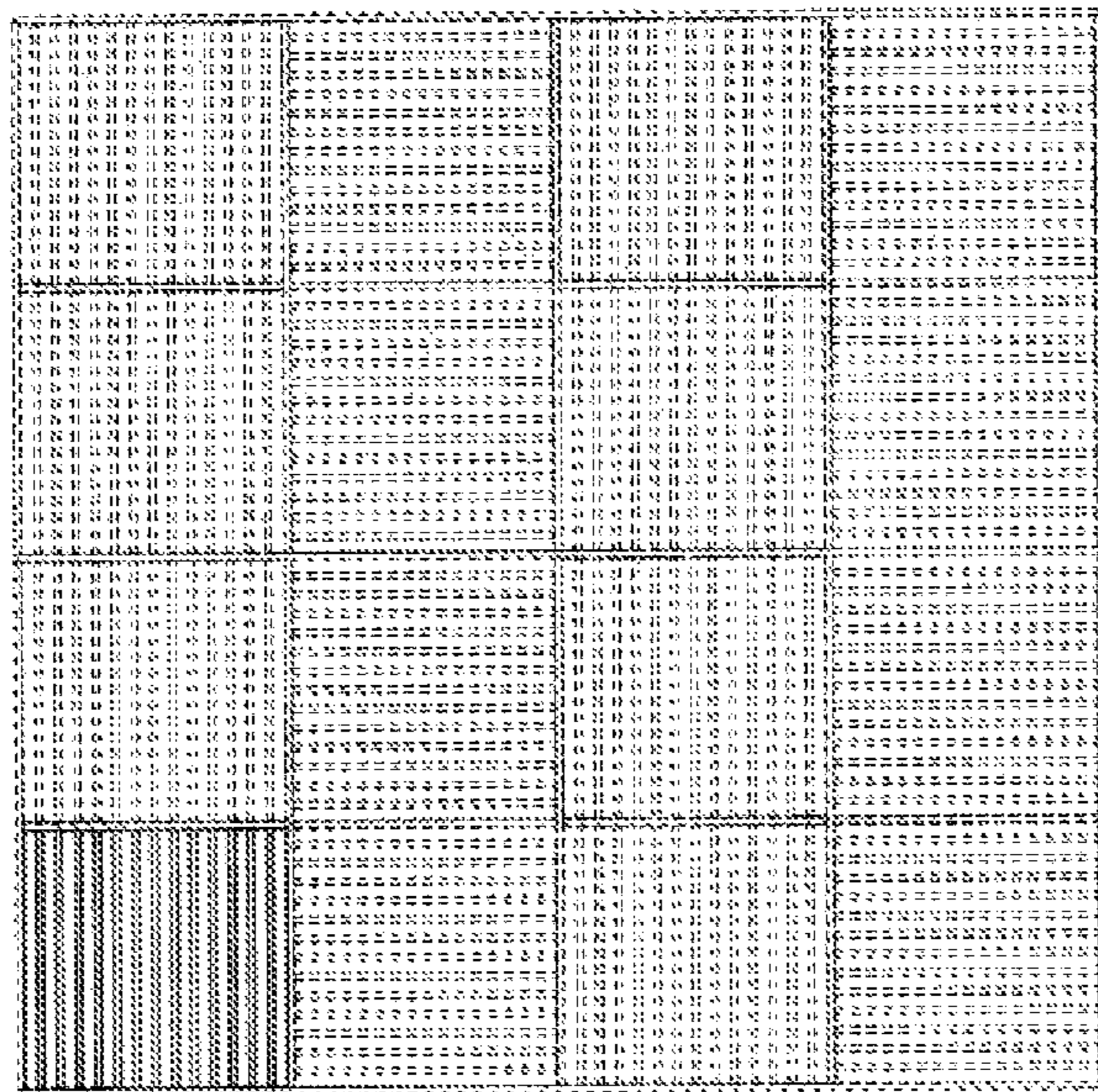

Fig. 10

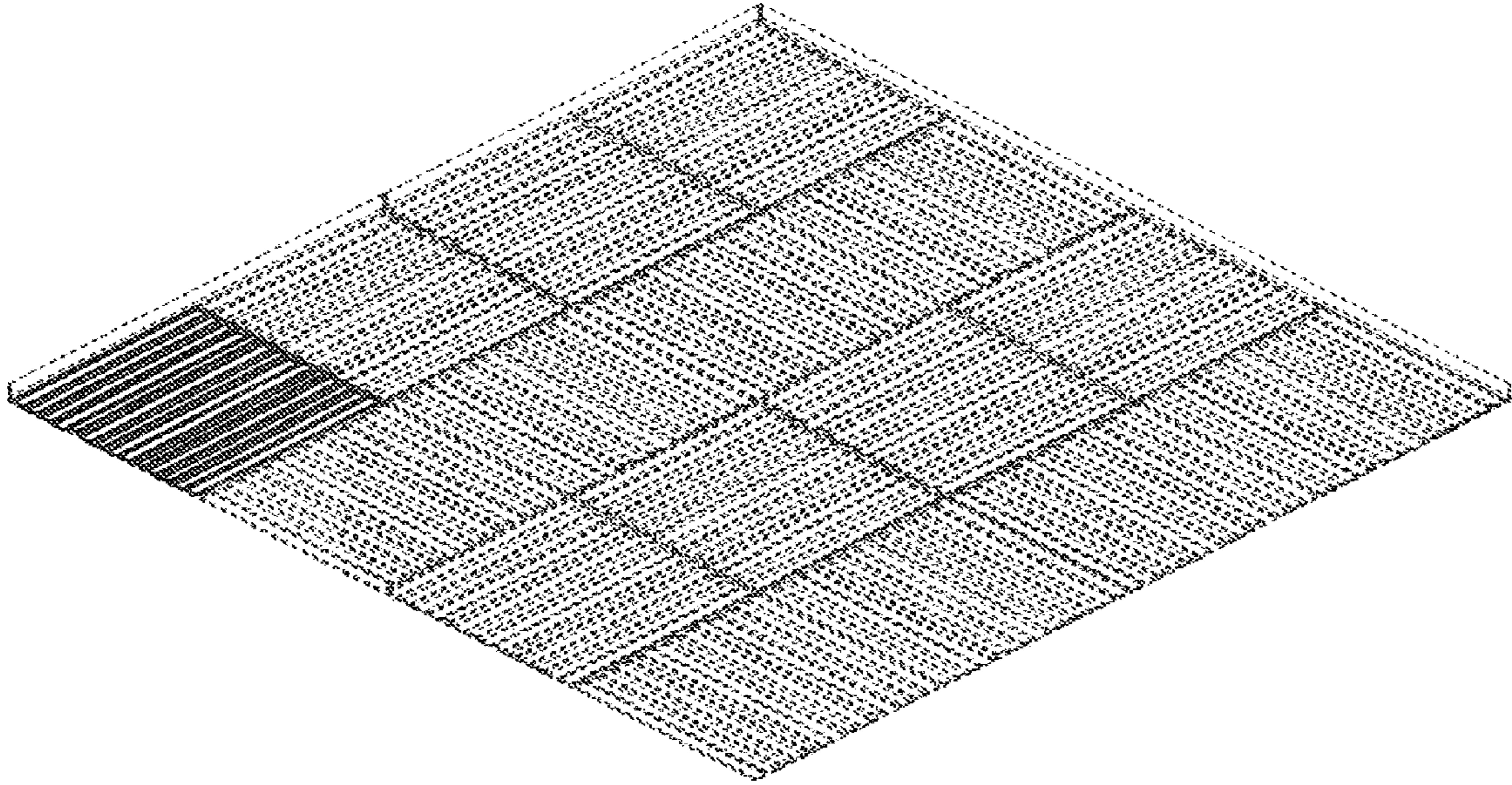

Fig. 11

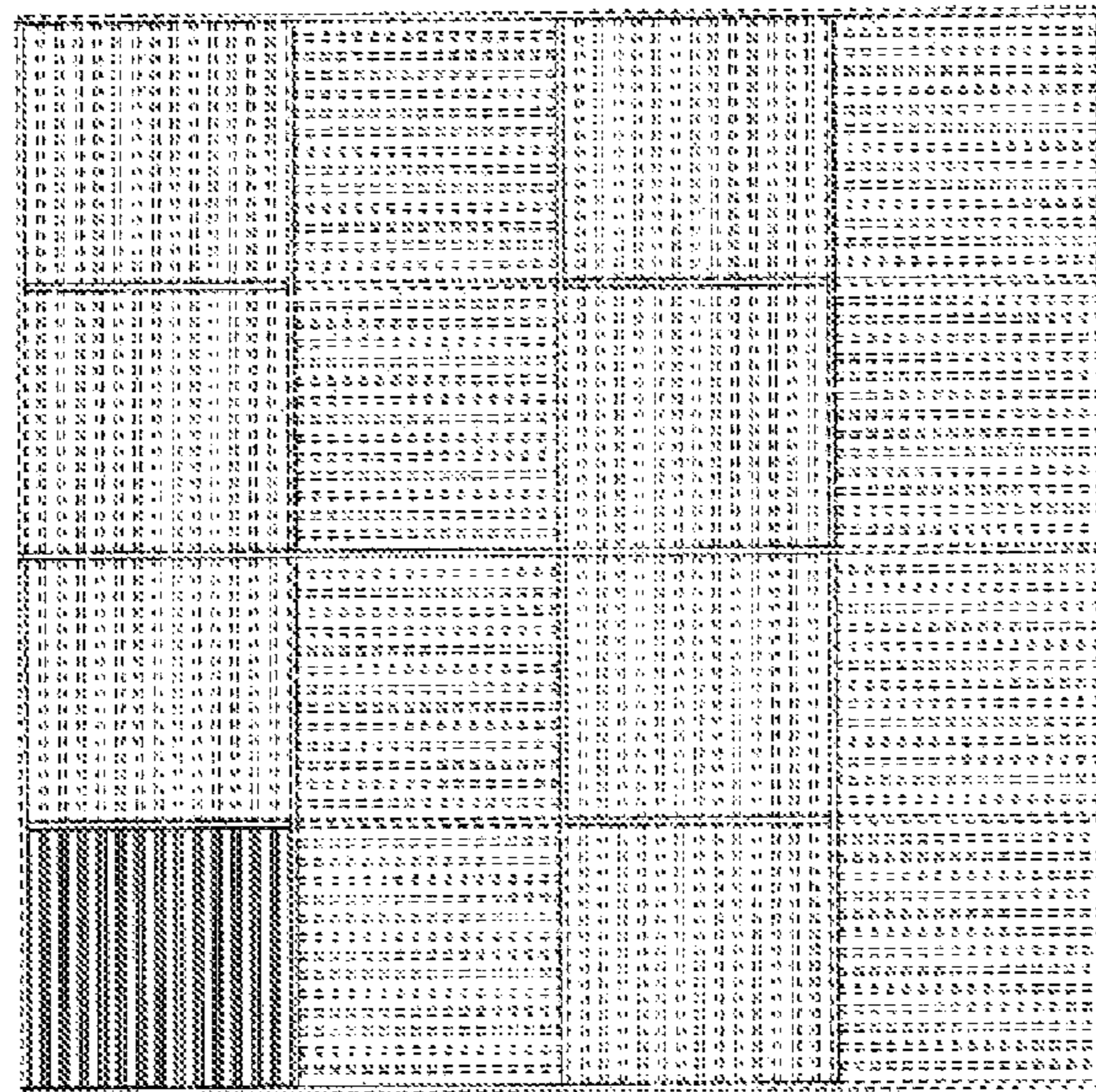

Fig. 12

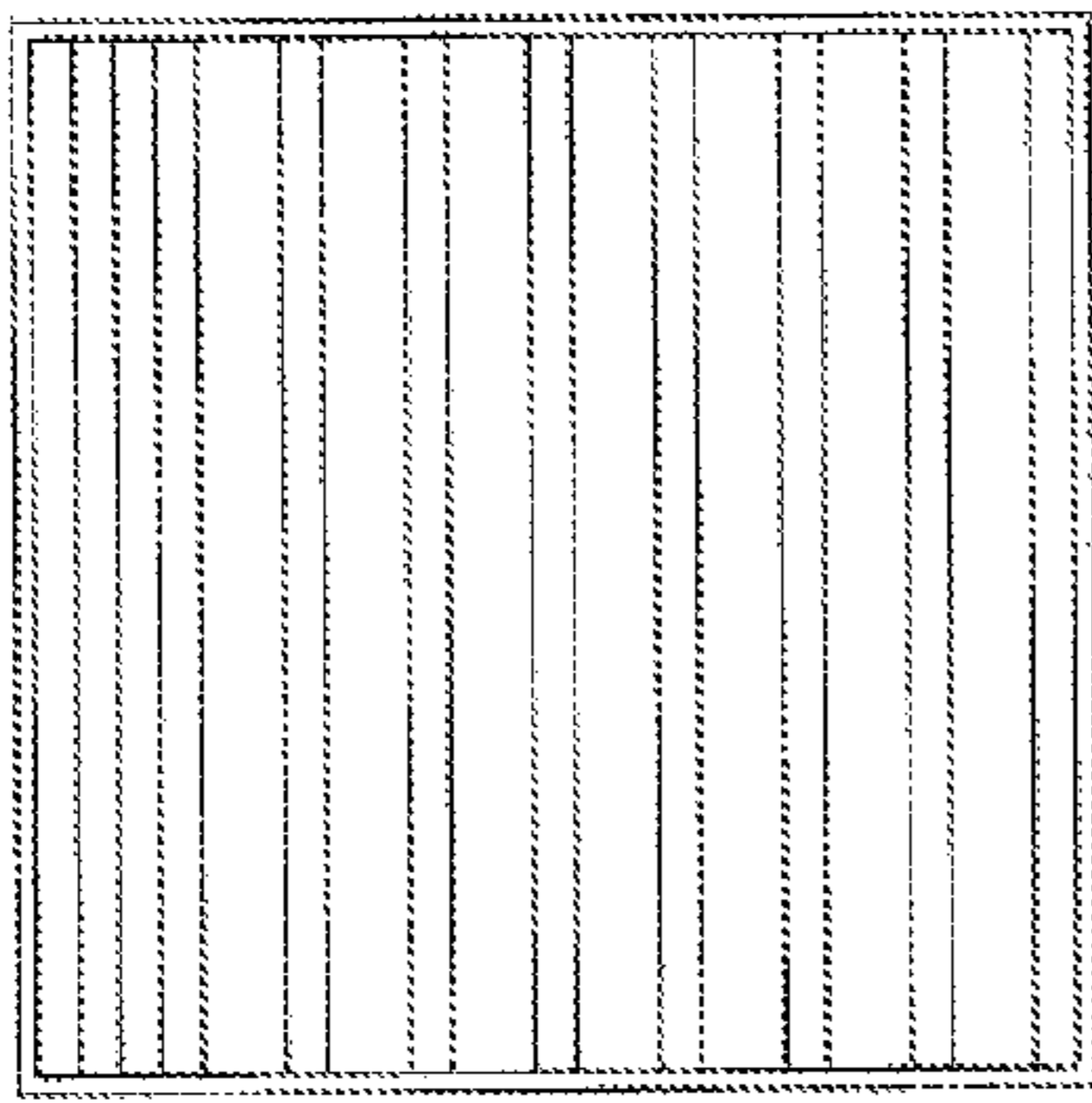

Fig. 13

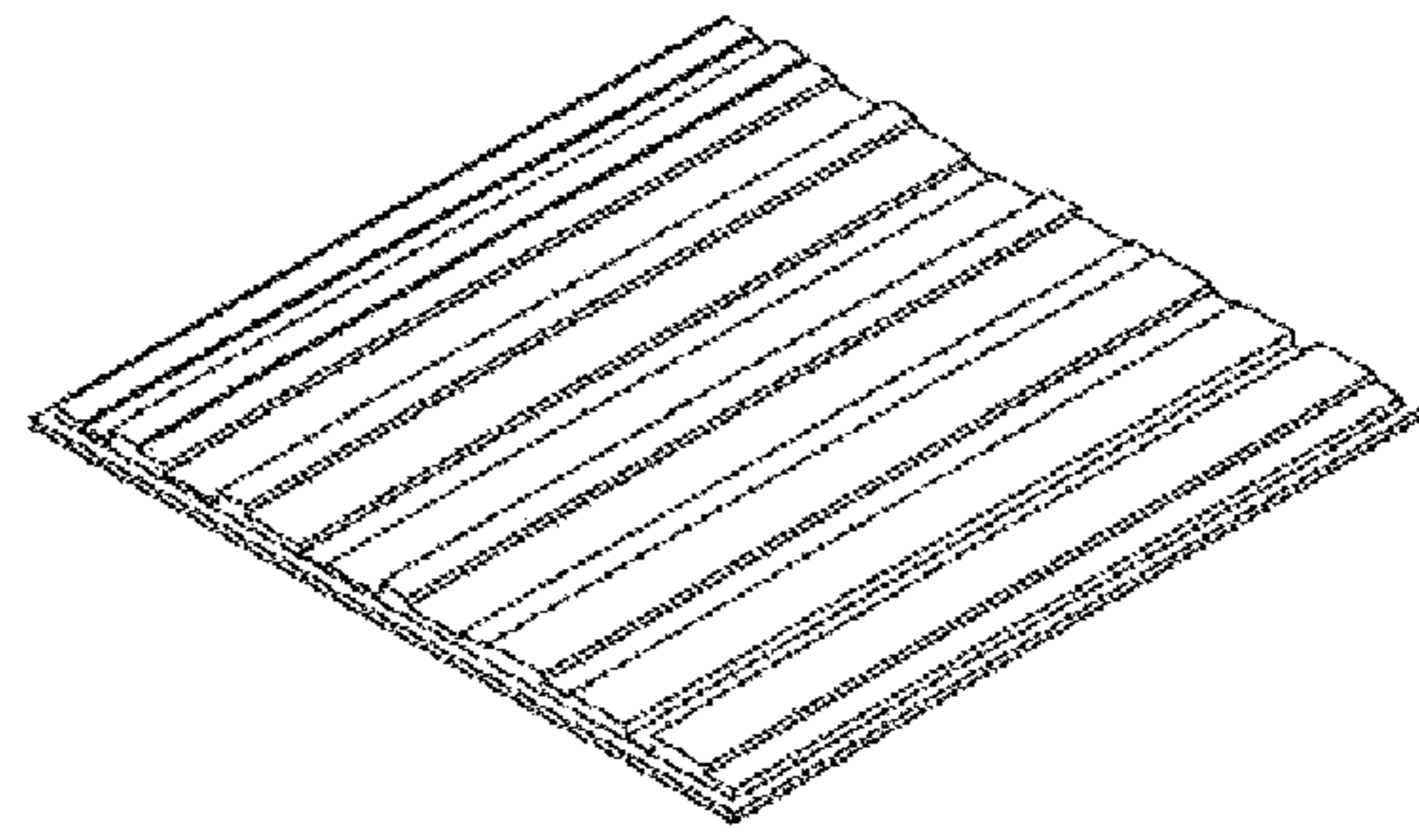

Fig. 14



Fig. 15

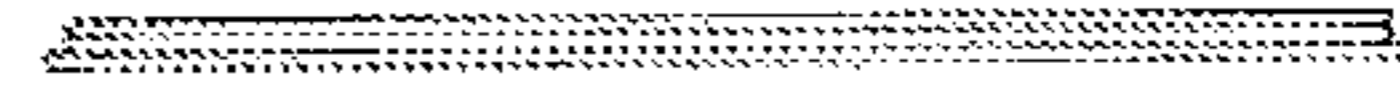

Fig. 16



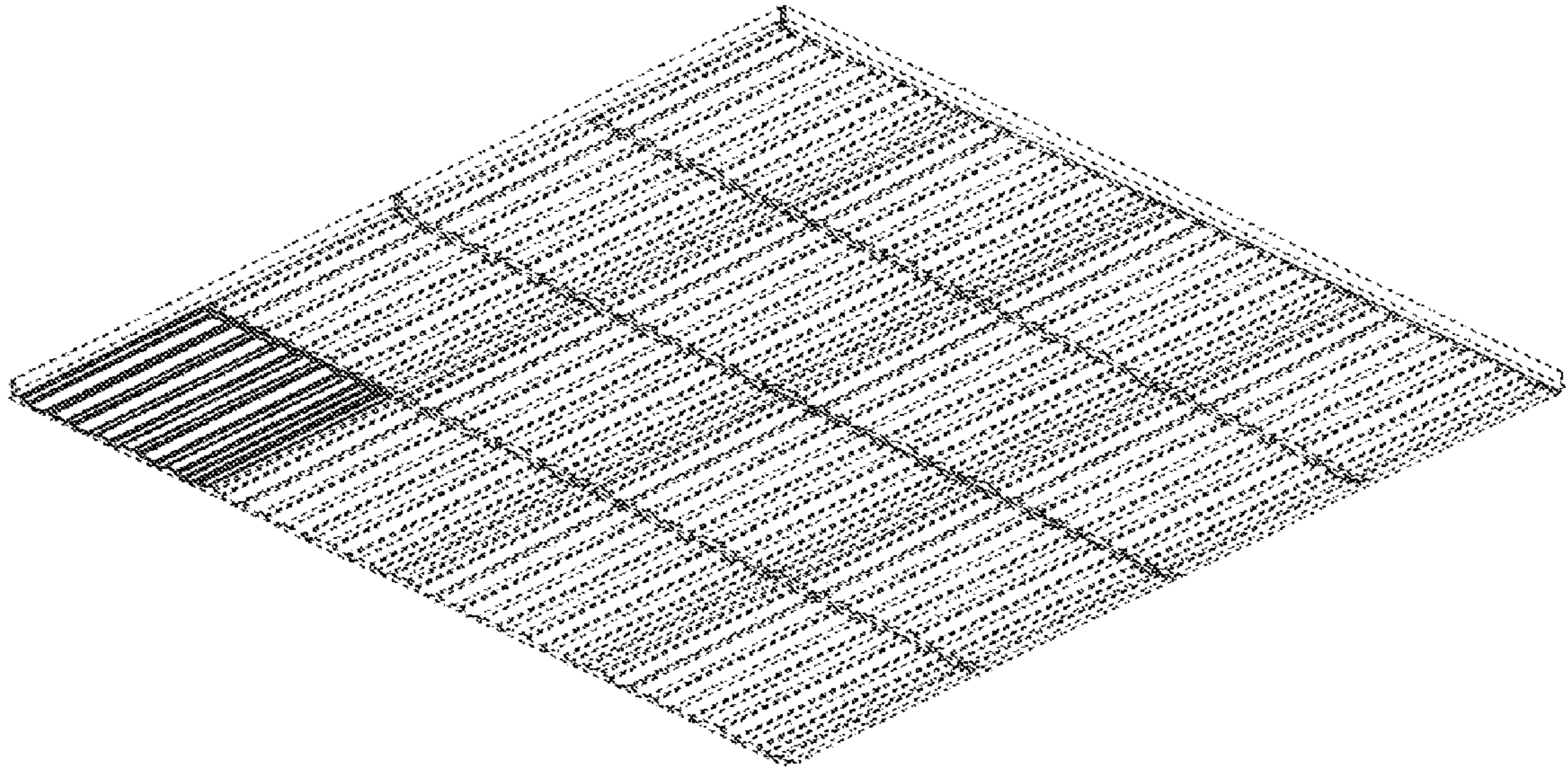

Fig. 17

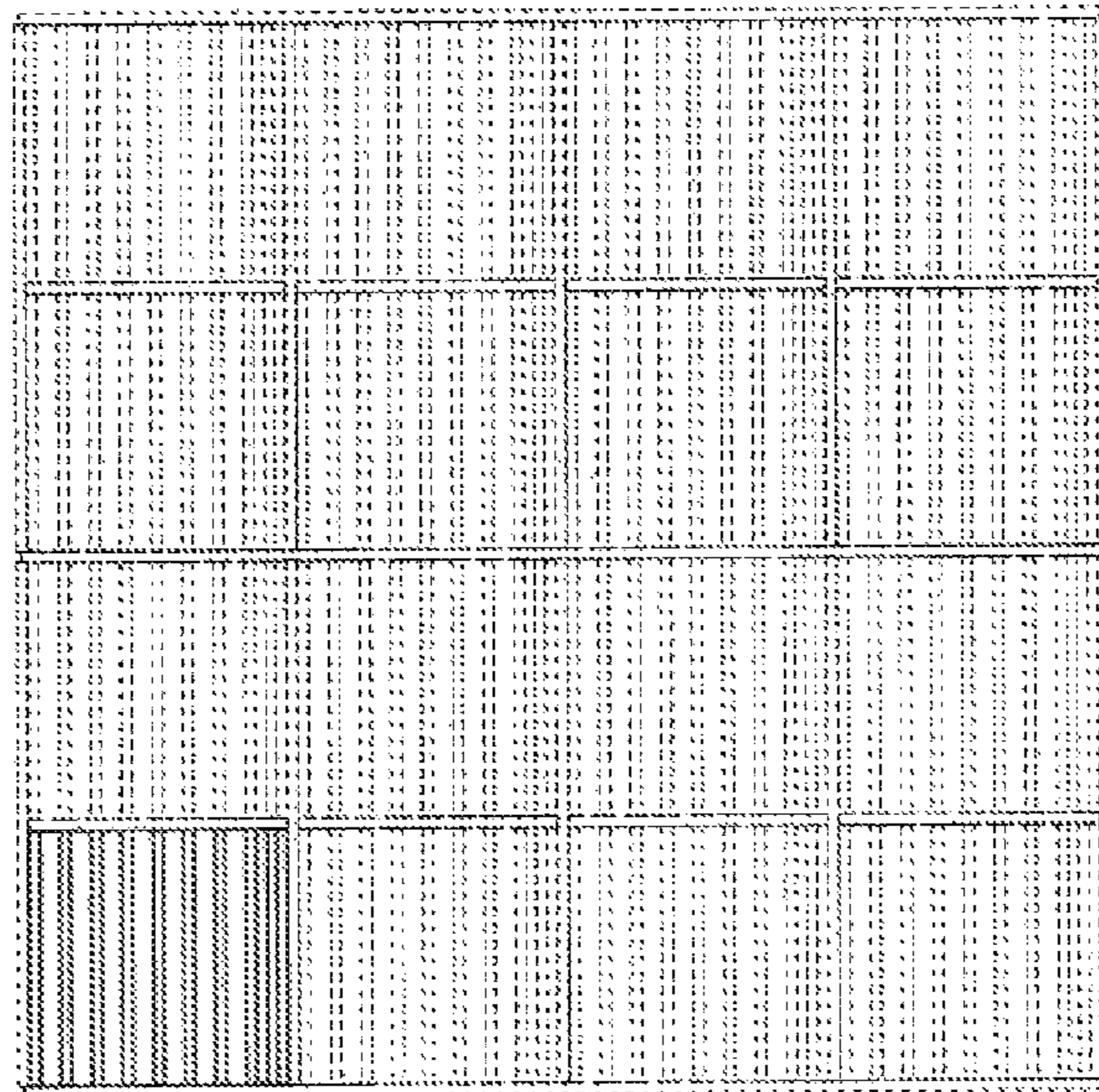

Fig. 18

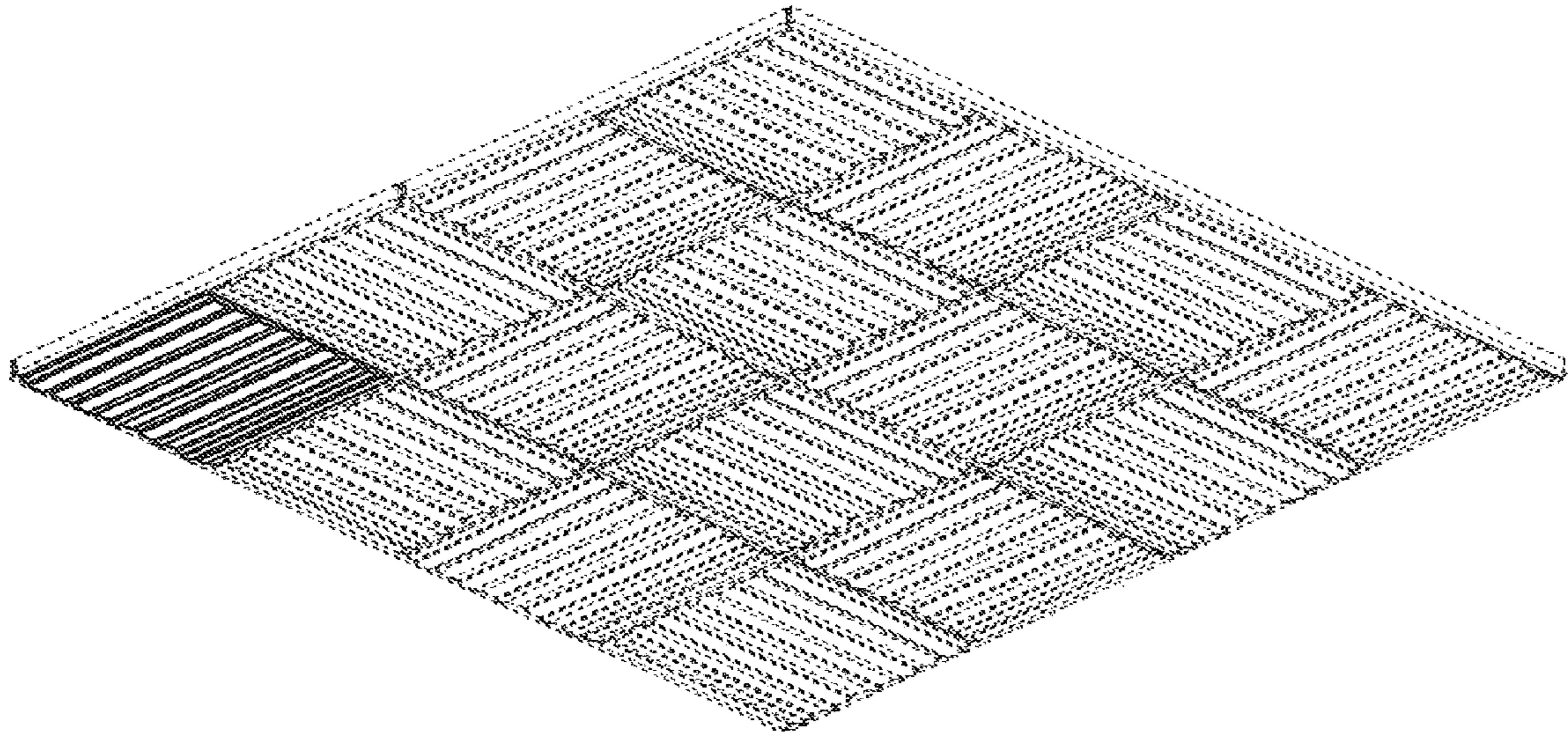

Fig. 19

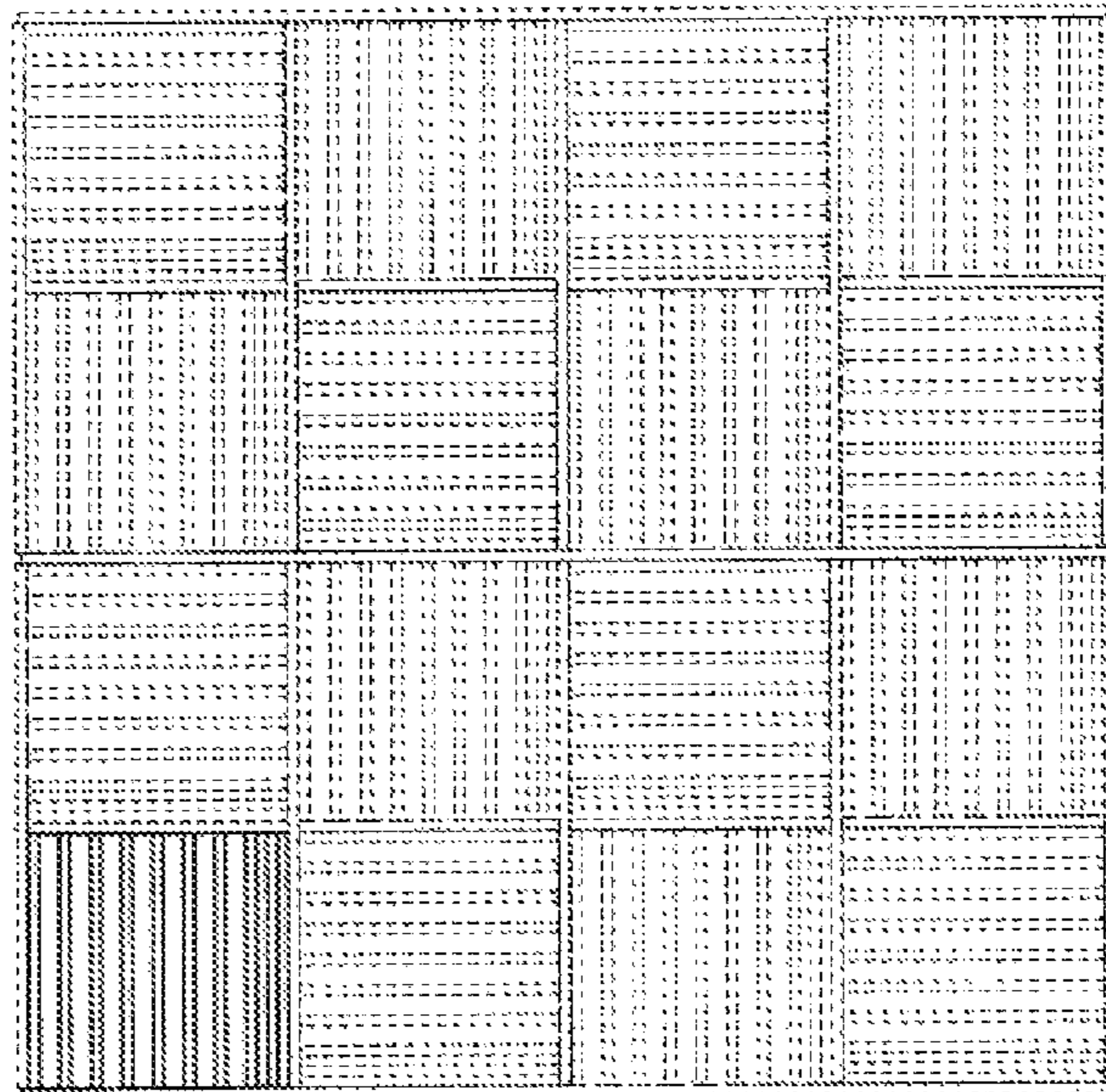

Fig. 20

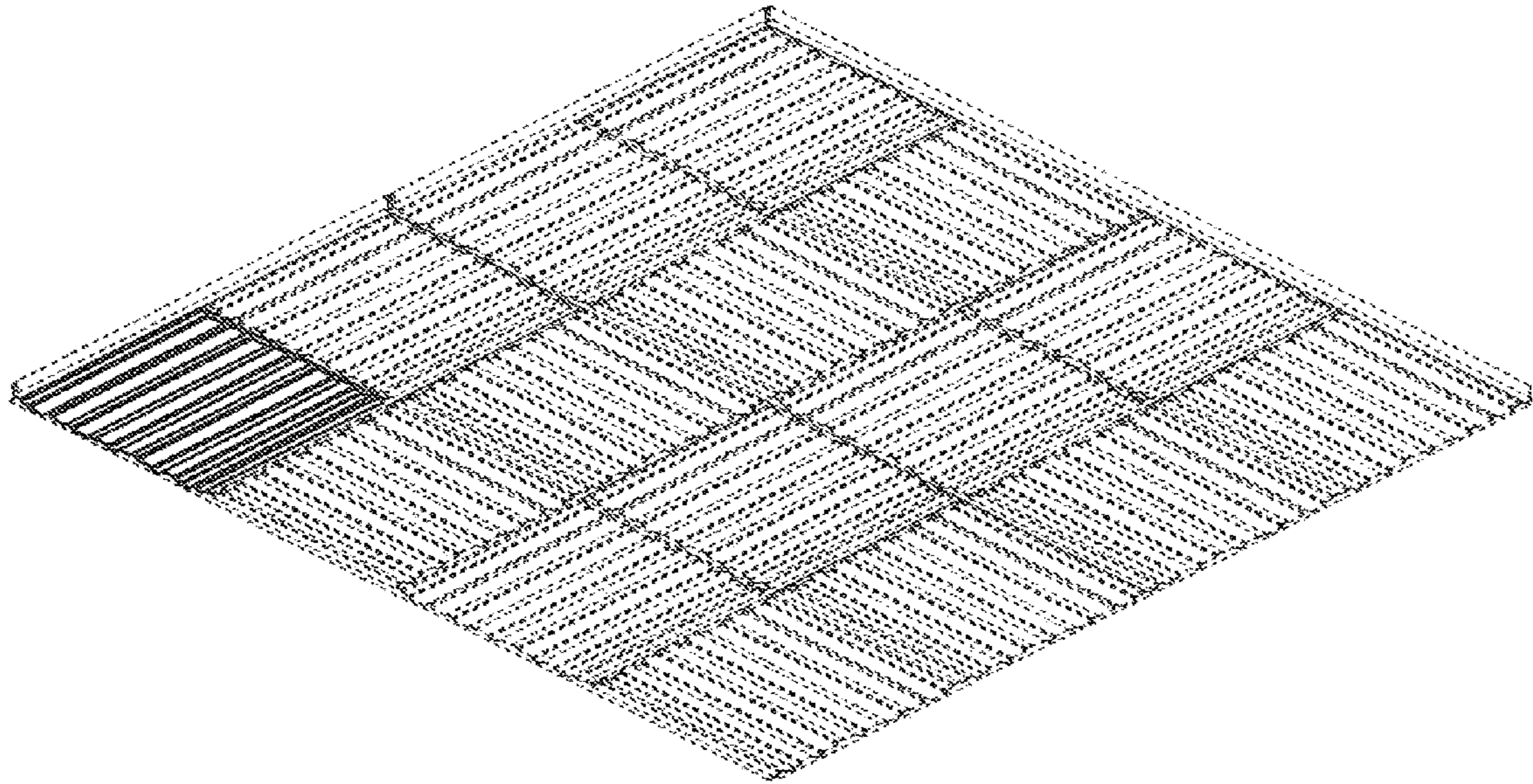

Fig. 21

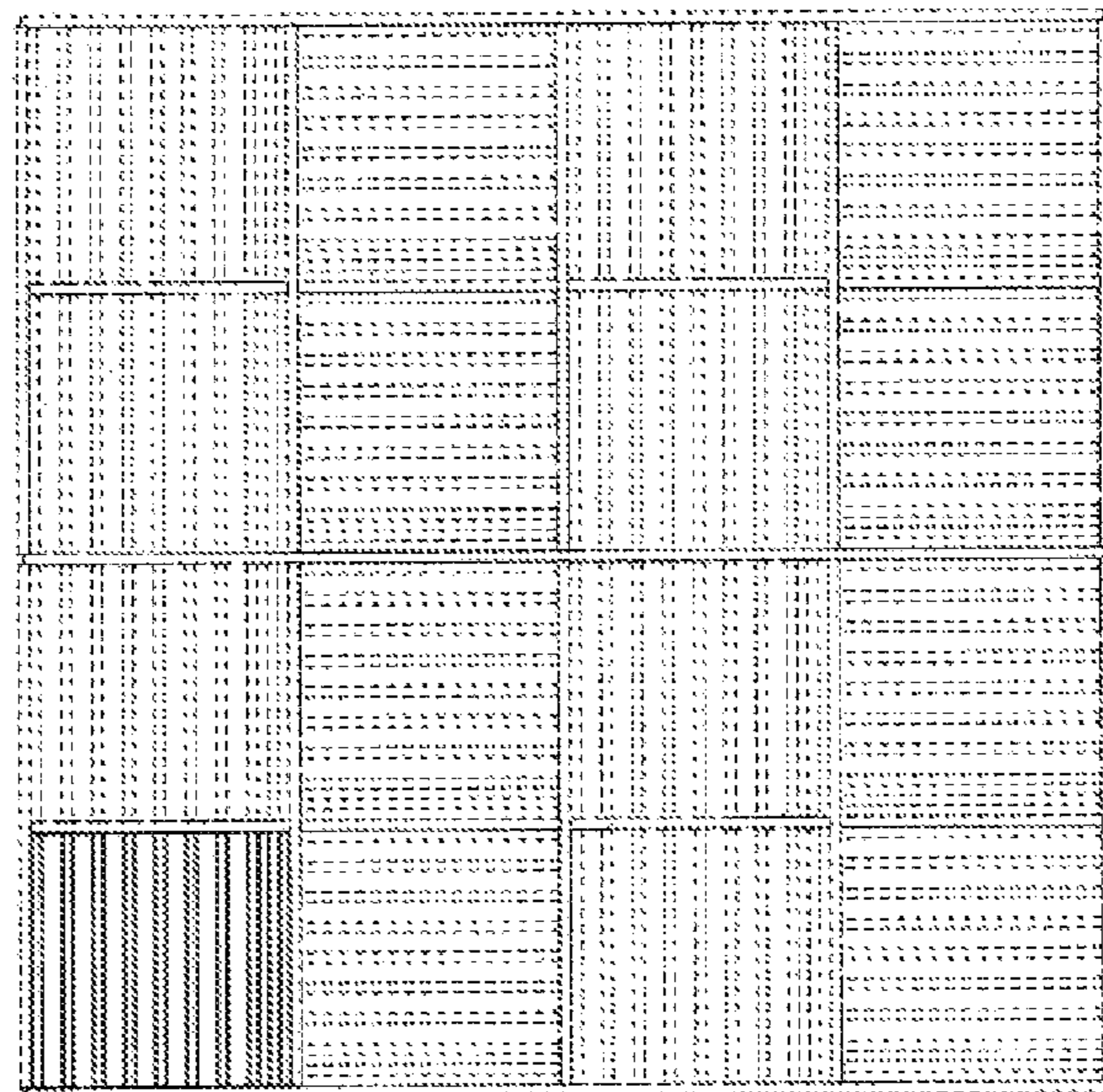

Fig. 22

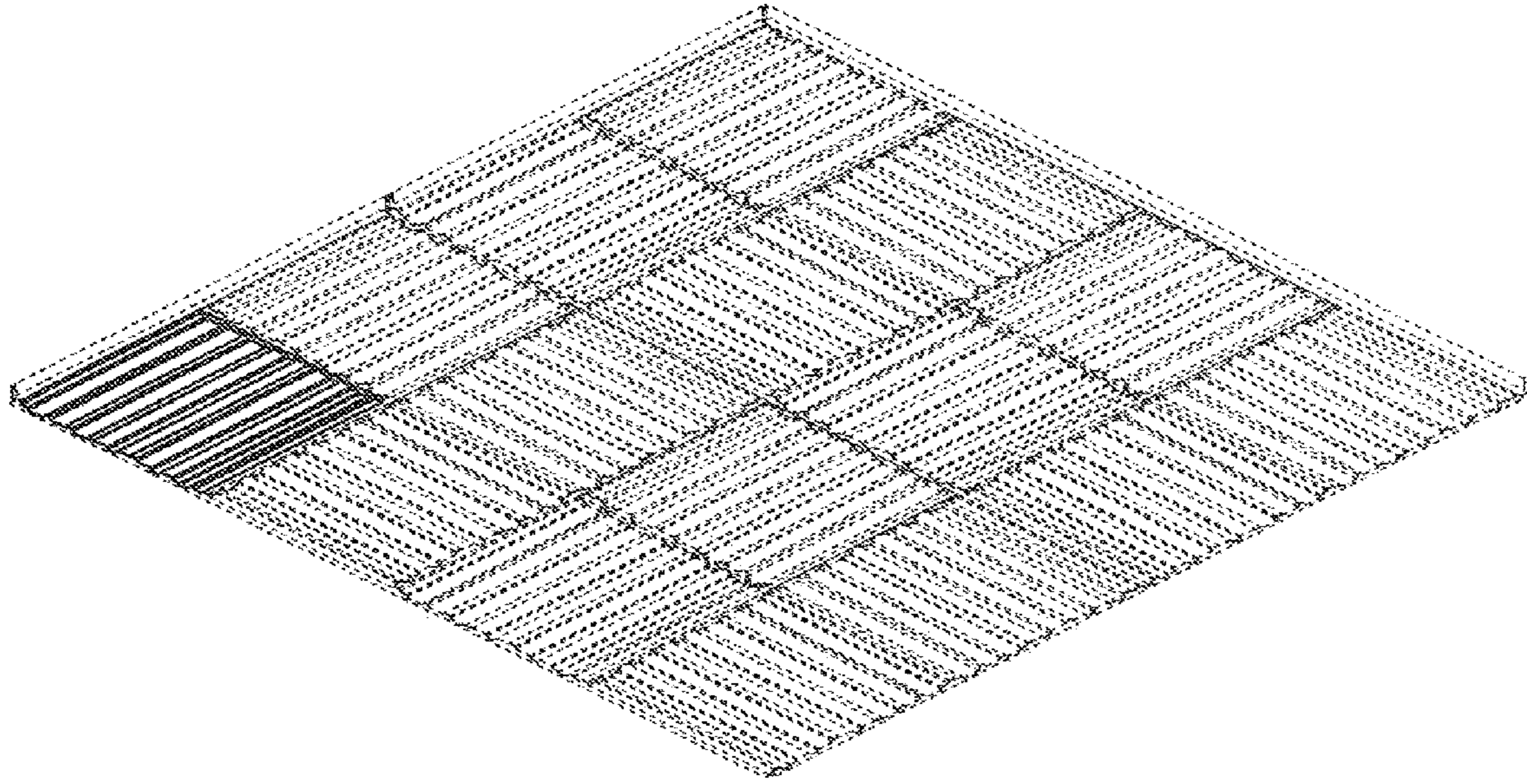

Fig. 23

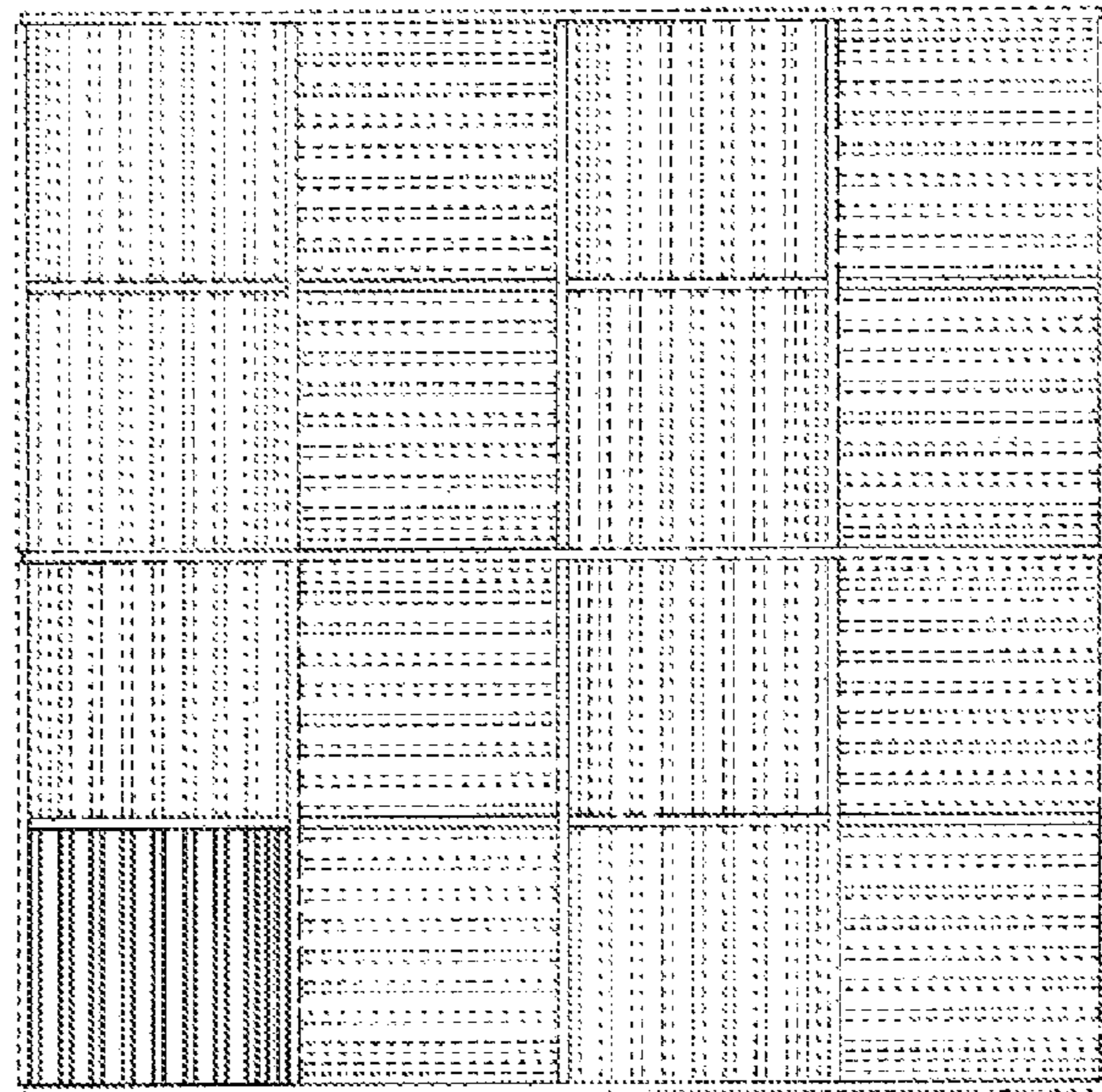

Fig. 24