



US00D631942S

(12) **United States Design Patent**
Koike et al.

(10) **Patent No.:** **US D631,942 S**
(45) **Date of Patent:** **** Feb. 1, 2011**

(54) **TANK ELEMENT**

(75) Inventors: **Atsushi Koike**, Ageo (JP); **Toshimi Nakamura**, Ageo (JP); **Kenjiro Izutani**, Ageo (JP)

(73) Assignee: **Mitsui Mining & Smelting Co., Ltd.**, Tokyo (JP)

(**) Term: **14 Years**

(21) Appl. No.: **29/322,540**

(22) Filed: **Aug. 6, 2008**

(30) **Foreign Application Priority Data**

Feb. 7, 2008	(JP)	2008-2662
Feb. 7, 2008	(JP)	2008-2663
Feb. 7, 2008	(JP)	2008-2664
Feb. 7, 2008	(JP)	2008-2665
Feb. 7, 2008	(JP)	2008-2667

(51) **LOC (9) Cl.** **23-01**

(52) **U.S. Cl.** **D23/233; D15/5**

(58) **Field of Classification Search** **D23/233, D23/235, 245; D15/1, 3, 5; 137/596.13, 137/597**

See application file for complete search history.

(56) **References Cited**

U.S. PATENT DOCUMENTS

D498,820 S *	11/2004	Fukai	D23/249
D513,786 S *	1/2006	Montano et al.	D23/233
D557,283 S *	12/2007	Miller et al.	D15/5
D557,284 S *	12/2007	Miller et al.	D15/5
D570,880 S *	6/2008	Miller et al.	D15/5
7,469,708 B2 *	12/2008	Koester	137/269
D591,309 S *	4/2009	Bobby et al.	D15/5
D606,163 S *	12/2009	Bobby et al.	D23/233
D607,087 S *	12/2009	Bobby et al.	D23/233
D622,735 S *	8/2010	Bobby et al.	D15/5
2008/0184775 A1	8/2008	Yamagishi et al.		

FOREIGN PATENT DOCUMENTS

JP 11153561 A 6/1999

JP	1073985 S	6/2000
JP	1073986 S	6/2000
JP	1074132 S	6/2000
JP	1074133 S	6/2000
JP	1084914 S	9/2000
JP	2007225609 A	9/2007

* cited by examiner

Primary Examiner—Cathron C. Brooks

Assistant Examiner—Maurice Stevens

(74) *Attorney, Agent, or Firm*—The Webb Law Firm

(57) **CLAIM**

The ornamental design for a tank element, as shown and described.

DESCRIPTION

FIG. 1 is a front view of the tank element showing the new design;

FIG. 2 is a top view of FIG. 1;

FIG. 3 is a bottom view of FIG. 1;

FIG. 4 is a right side view of FIG. 1;

FIG. 5 is a left side view of FIG. 1;

FIG. 6 is a perspective view of the tank element of FIG. 1 disposed on the lower center of the front surface of a tank;

FIG. 7 is a front view of FIG. 6;

FIG. 8 is a top view of FIG. 6;

FIG. 9 is a bottom view of FIG. 6;

FIG. 10 is a back view of FIG. 6;

FIG. 11 is a right side view of FIG. 6;

FIG. 12 is a left side view of FIG. 6;

FIG. 13 is a perspective view of the tank element of FIG. 1 disposed on the lower left of the front surface of a tank;

FIG. 14 is a front view of FIG. 13;

FIG. 15 is a top view of FIG. 13;

FIG. 16 is a bottom view of FIG. 13;

FIG. 17 is a back view of FIG. 13;

FIG. 18 is a right side view of FIG. 13;

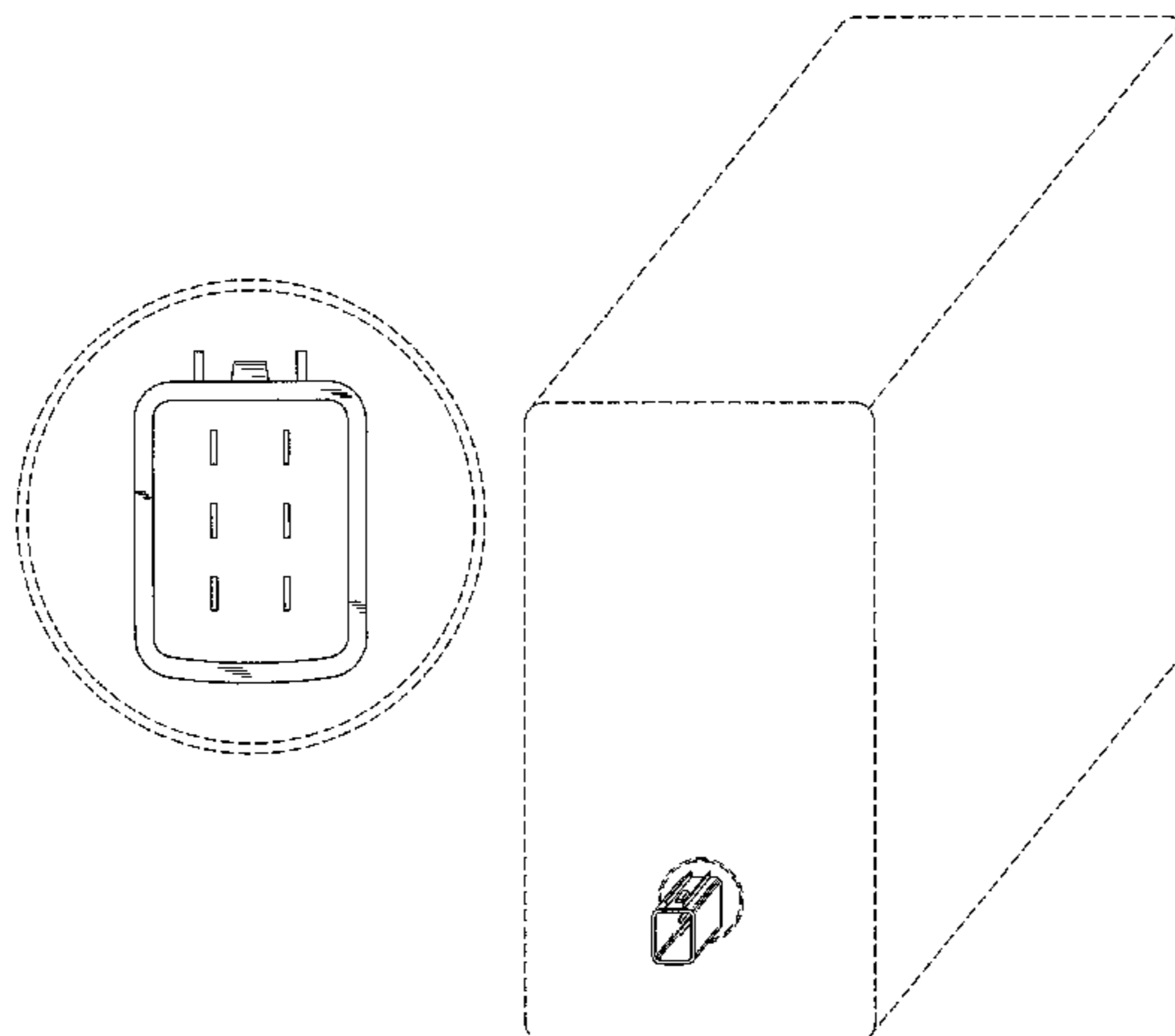

FIG. 19 is a left side view of FIG. 13;

FIG. 20 is a perspective view of the tank element of FIG. 1 disposed on the center of the bottom surface of a tank;

FIG. 21 is a front view of FIG. 20;

FIG. 22 is a top view of FIG. 20;

FIG. 23 is a bottom view of FIG. 20;

FIG. 24 is a back view of FIG. 20;

FIG. 25 is a right side view of FIG. 20;

FIG. 26 is a left side view of FIG. 20;

FIG. 27 is a perspective bottom view of the tank element of FIG. 1 disposed on the upper right portion of the bottom surface of a tank;

FIG. 28 is a front view of FIG. 27;

FIG. 29 is a top view of FIG. 27;

FIG. 30 is a bottom view of FIG. 27;

FIG. 31 is a back view of FIG. 27;

FIG. 32 is a right side view of FIG. 27;

FIG. 33 is a left side view of FIG. 27;

FIG. 34 is a perspective view of the tank element of FIG. 1 disposed on center of the front surface of a tank;

FIG. 35 is a front view of FIG. 34;

FIG. 36 is a top view of FIG. 34;

FIG. 37 is a bottom view of FIG. 34;

FIG. 38 is a back view of FIG. 34;

FIG. 39 is a right side view of FIG. 34; and,

FIG. 40 is a left side view of FIG. 34.

The broken lines in FIGS. 1-40 represent environment and are for illustrative purposes only and do not constitute part of the claimed design.

1 Claim, 38 Drawing Sheets

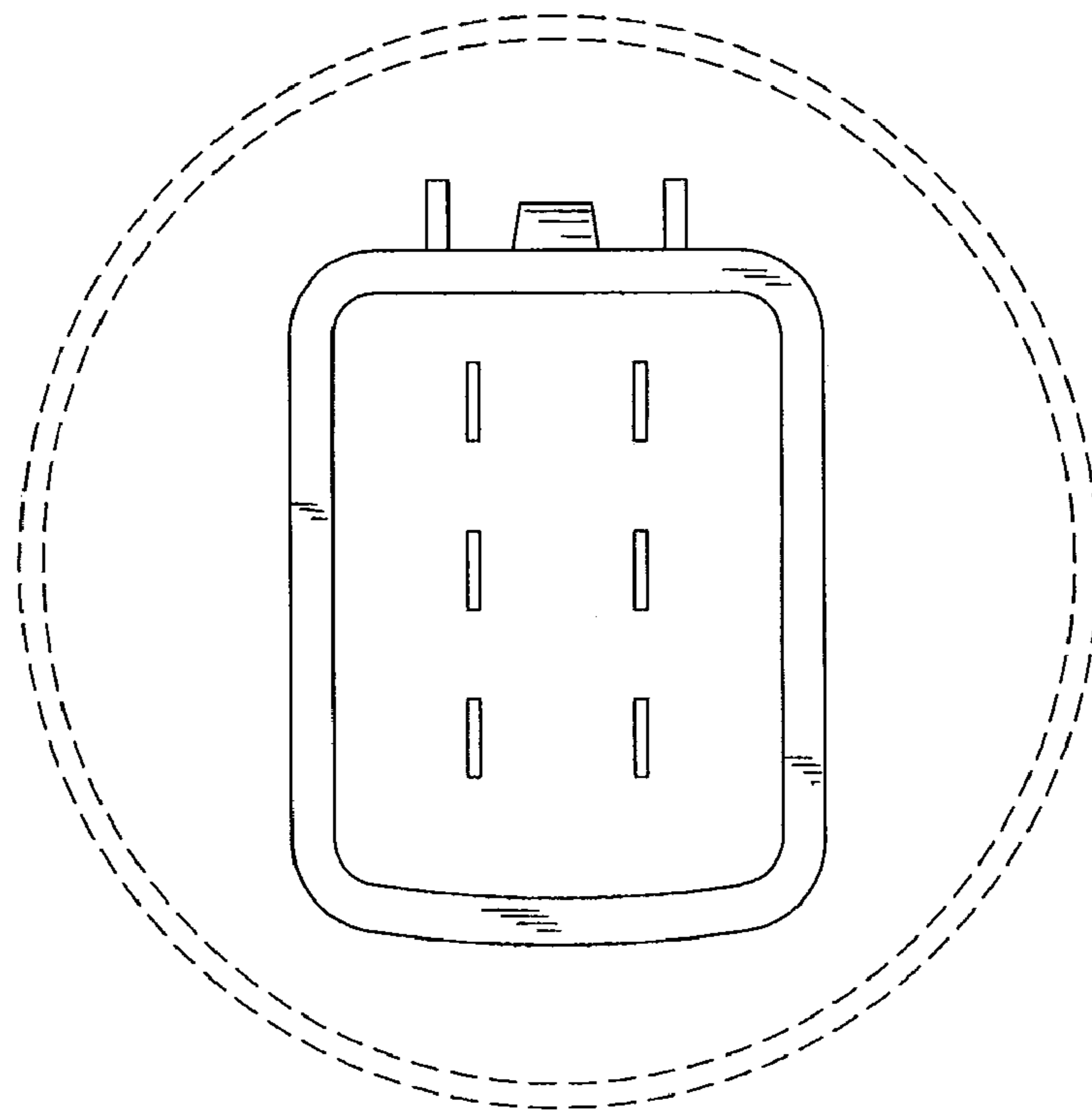

FIG. 1

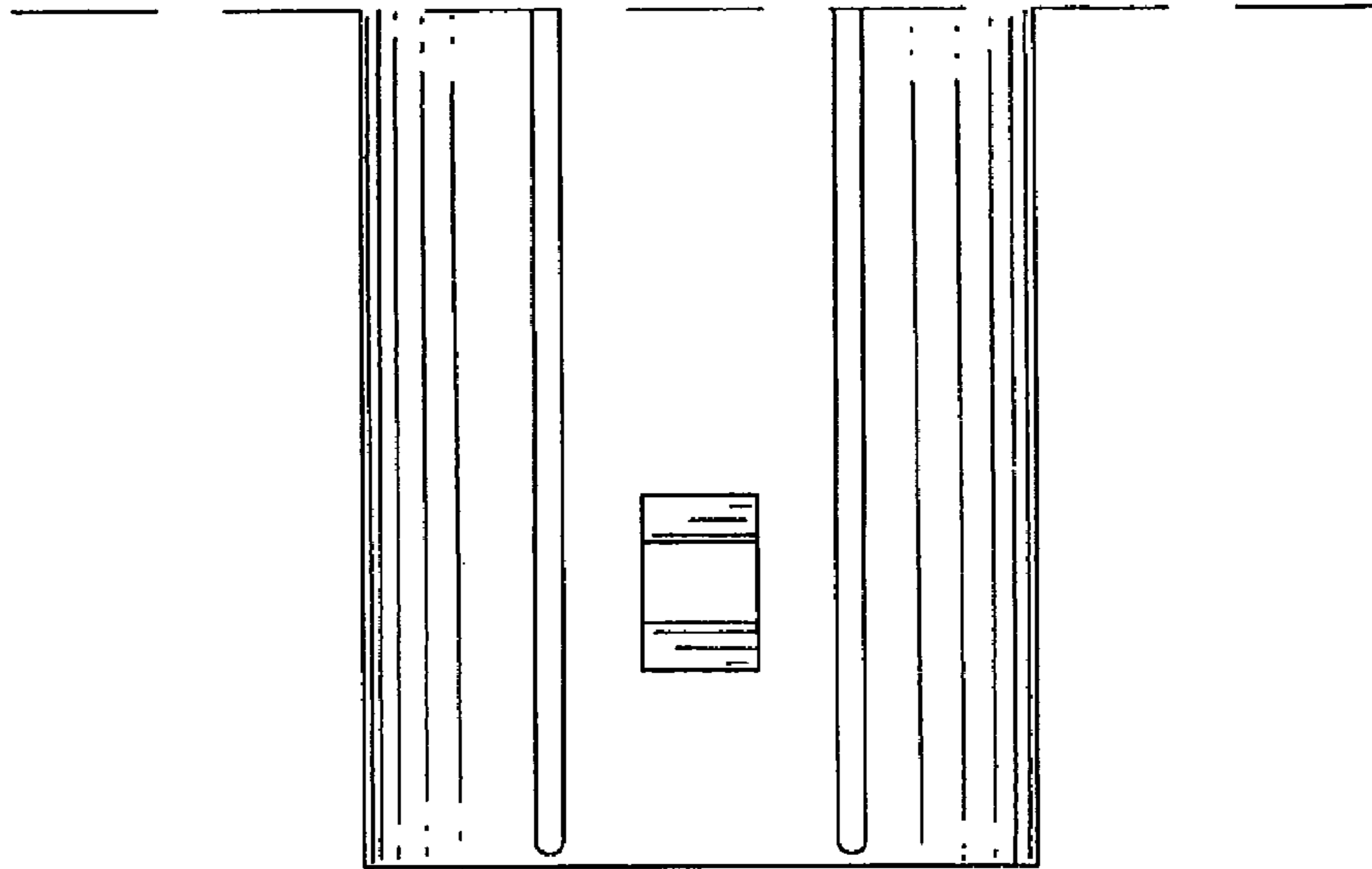

FIG. 2

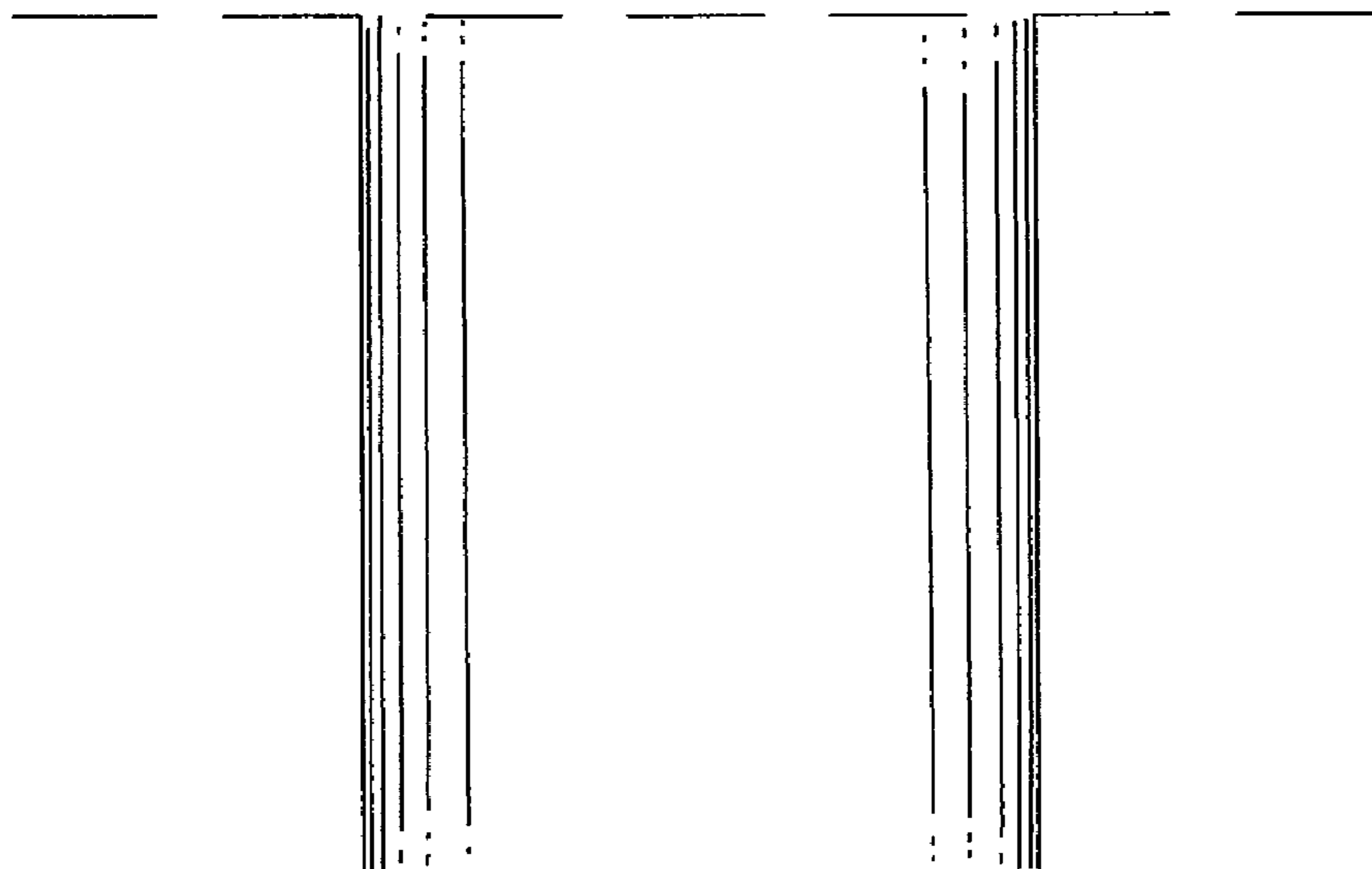

FIG. 3

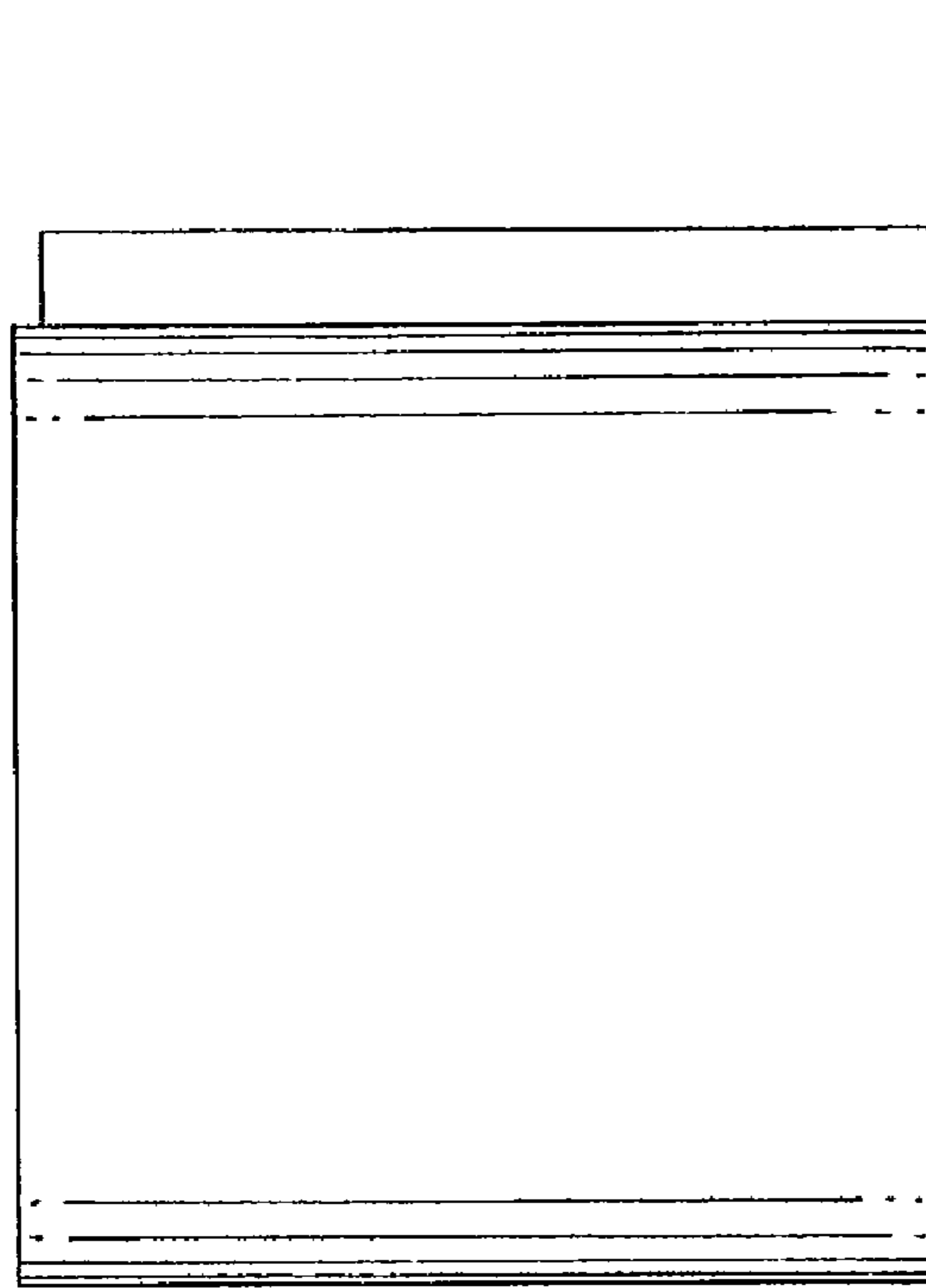

FIG. 4

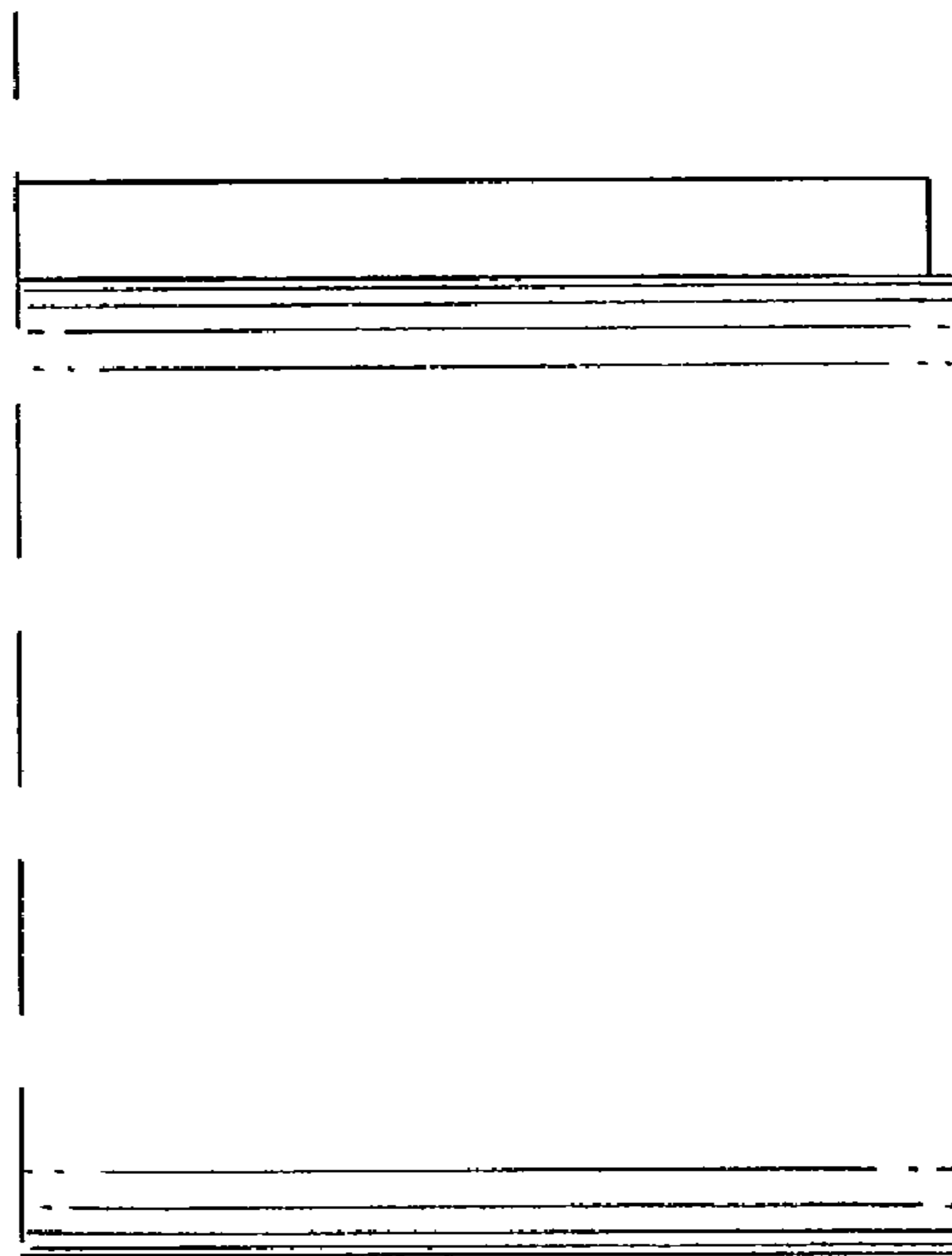

FIG. 5

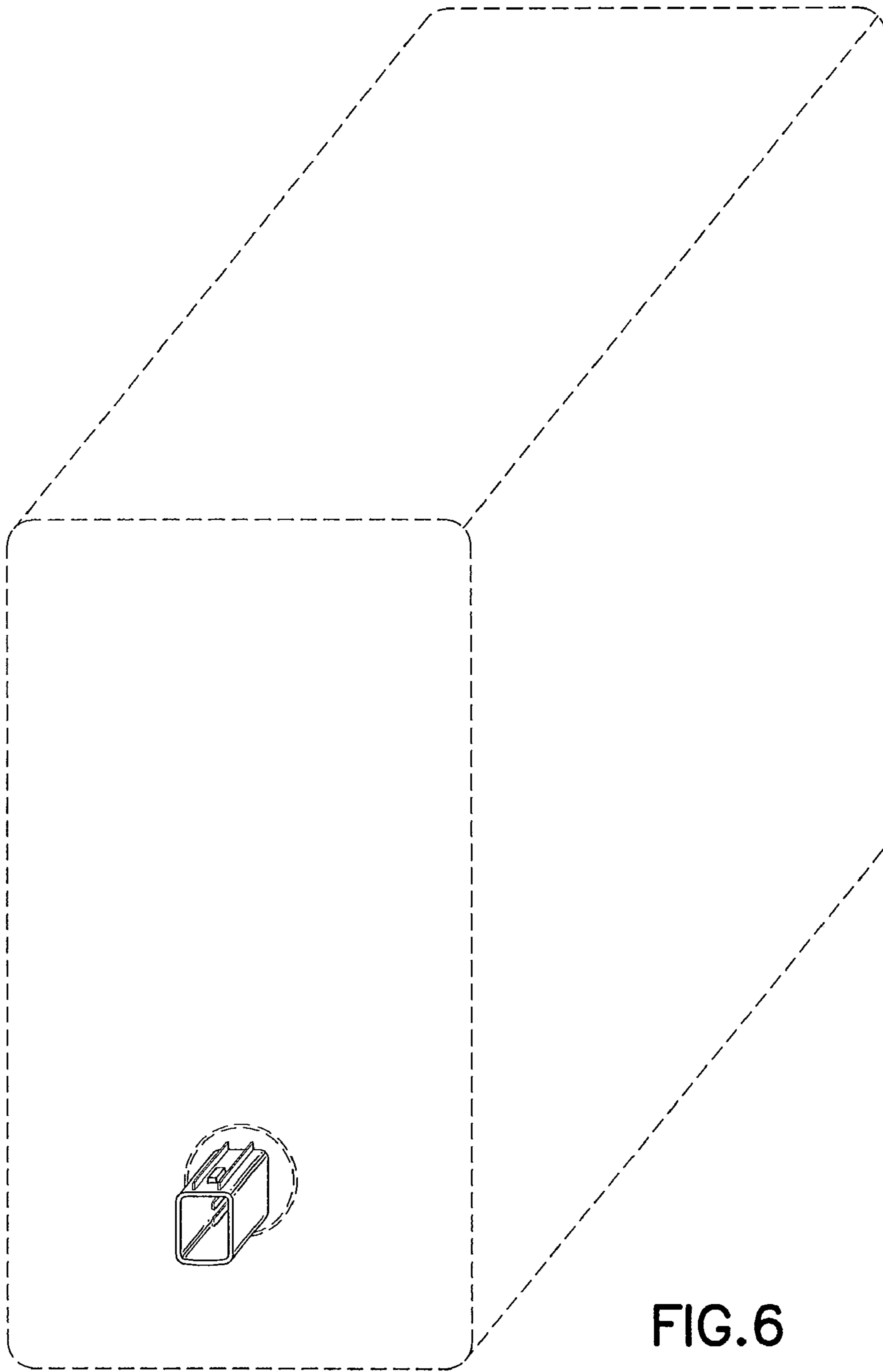

FIG. 6

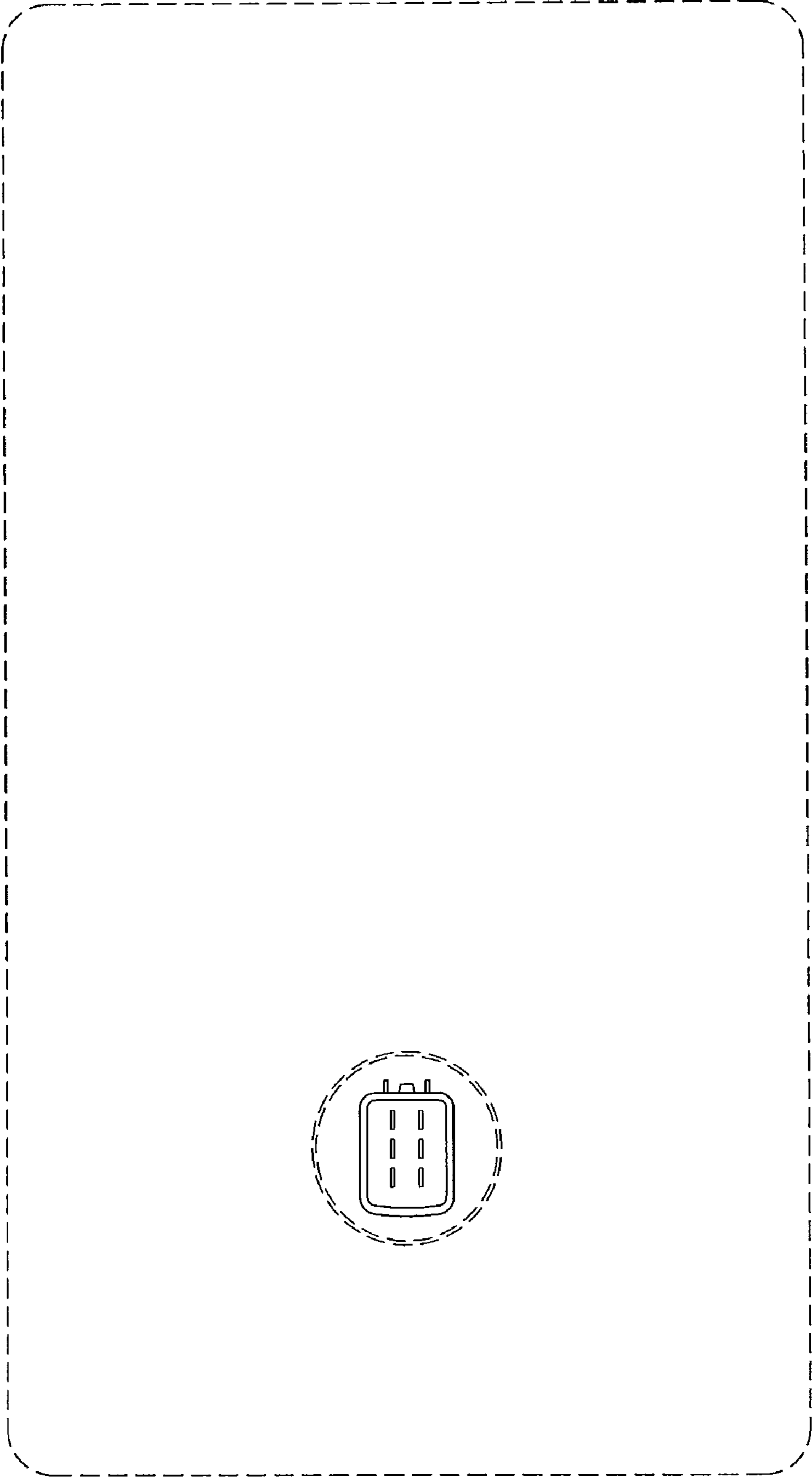

FIG.7

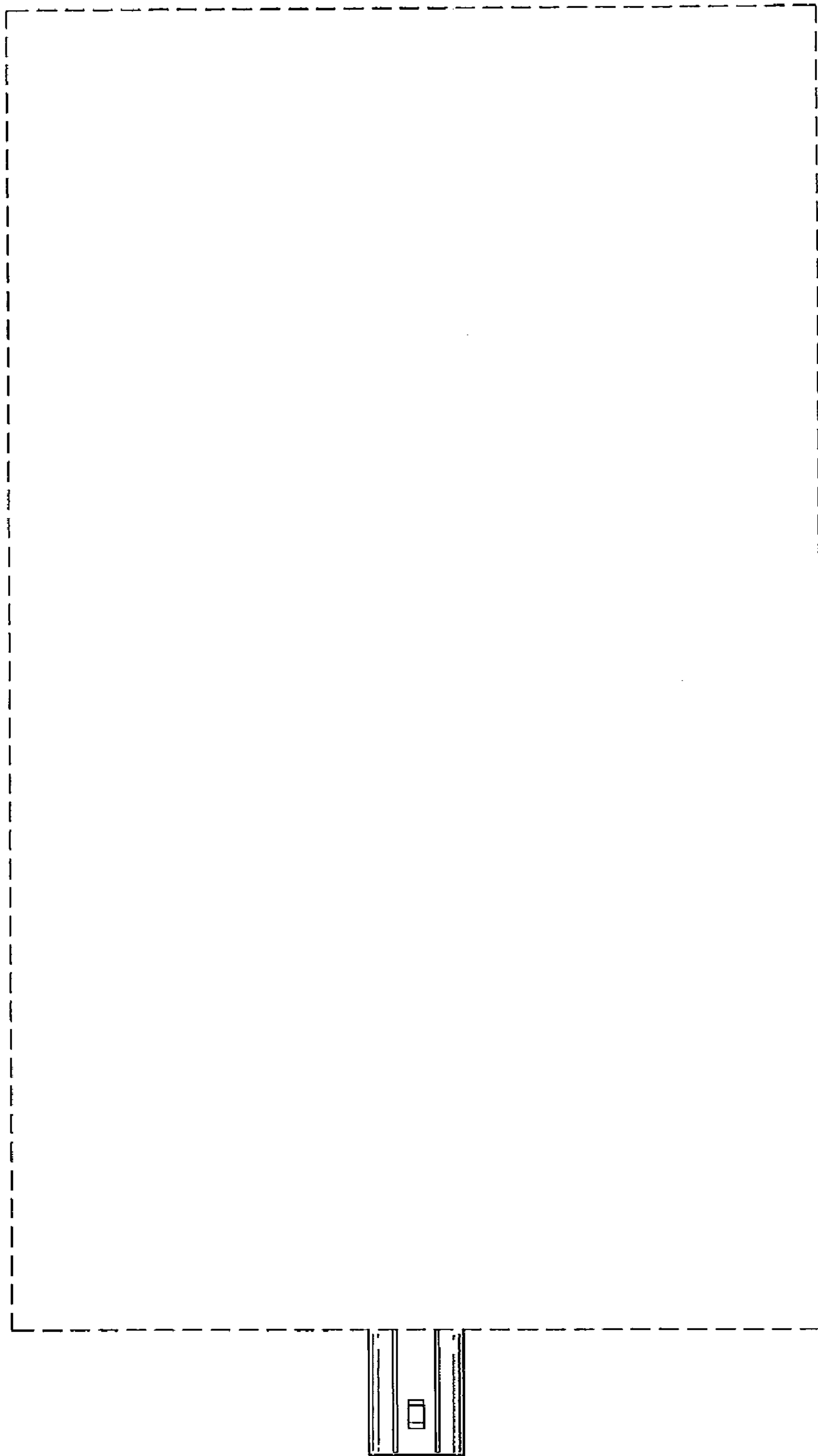

FIG.8

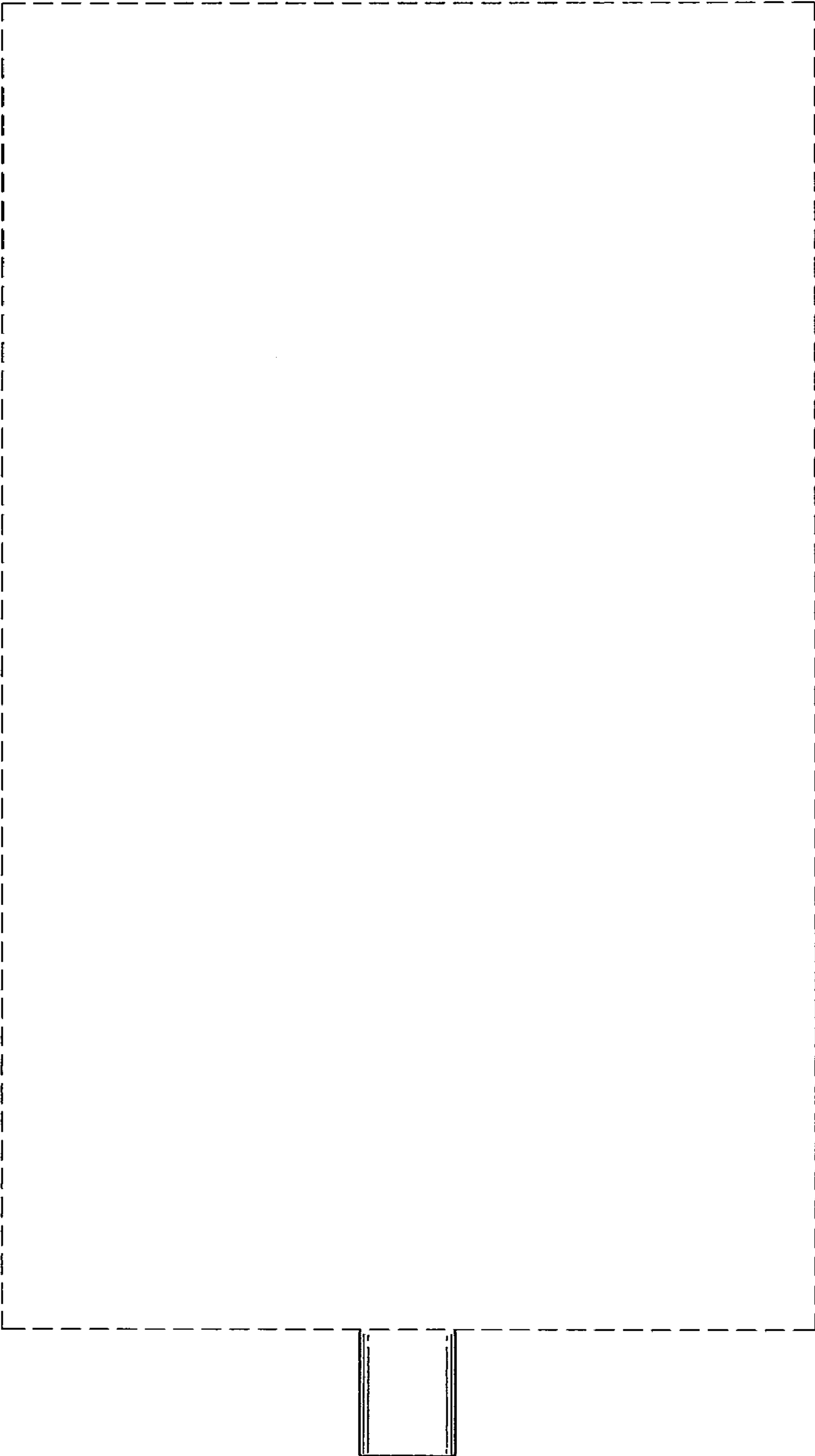

FIG.9

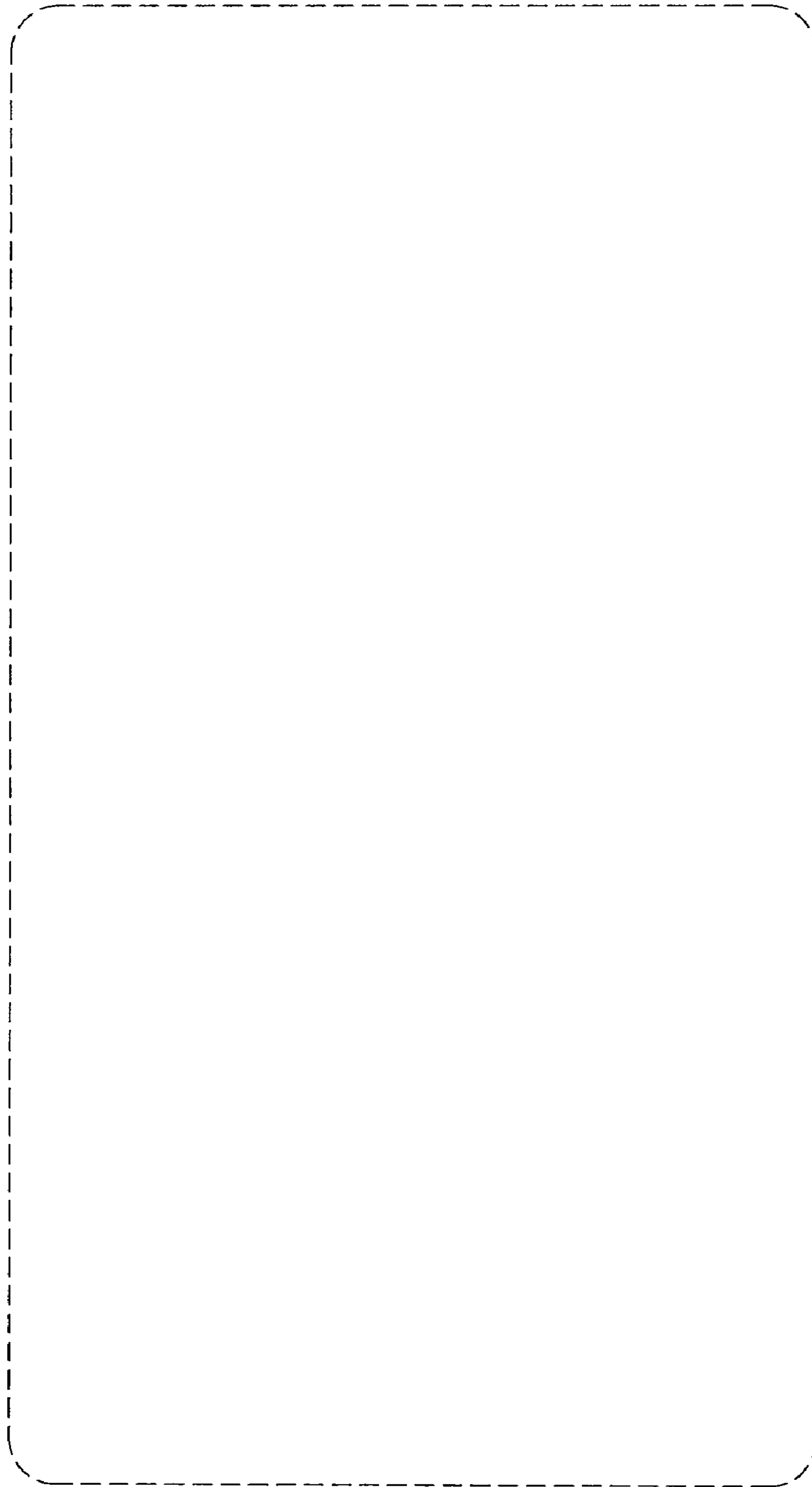

FIG. 10

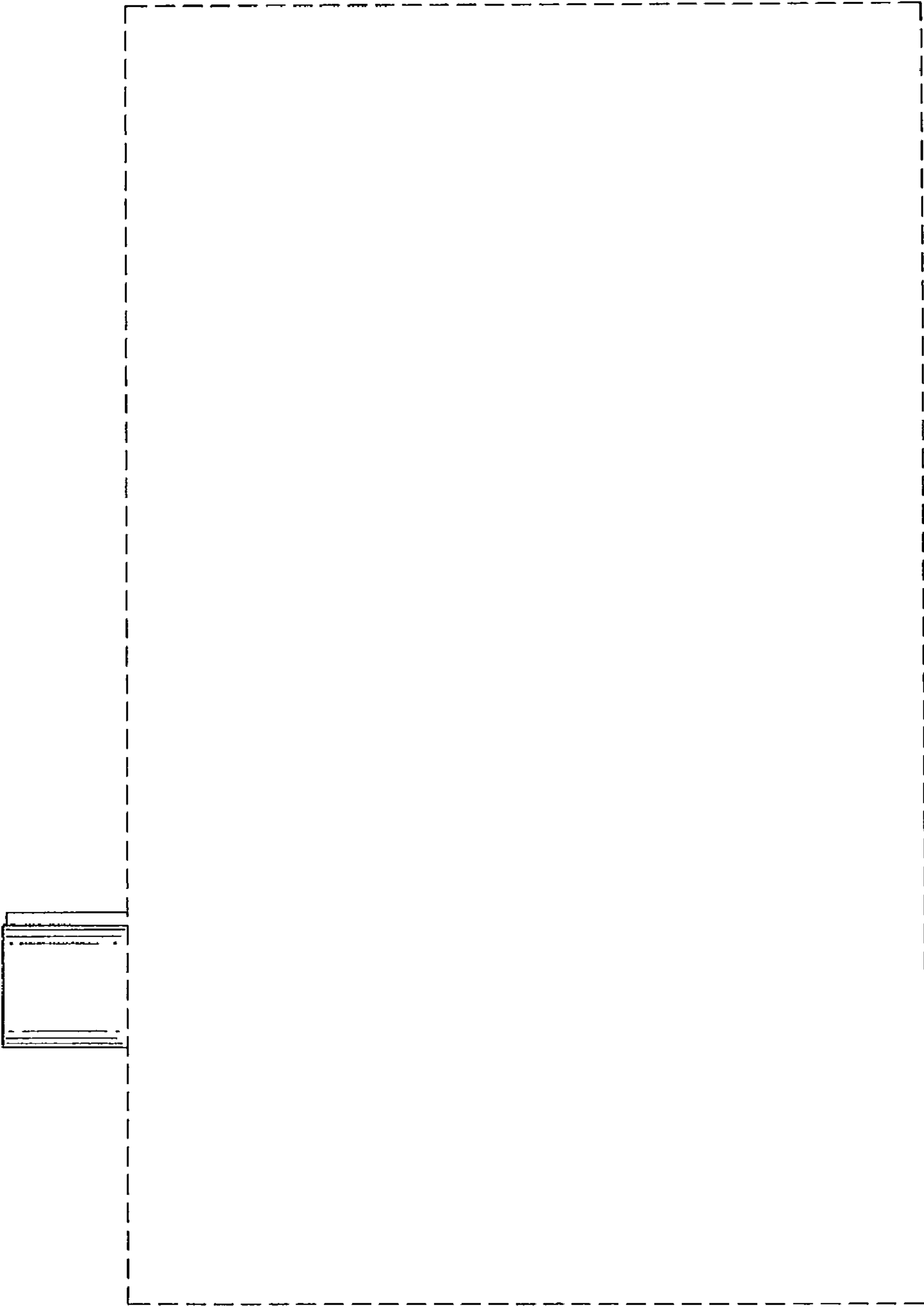

FIG. 11

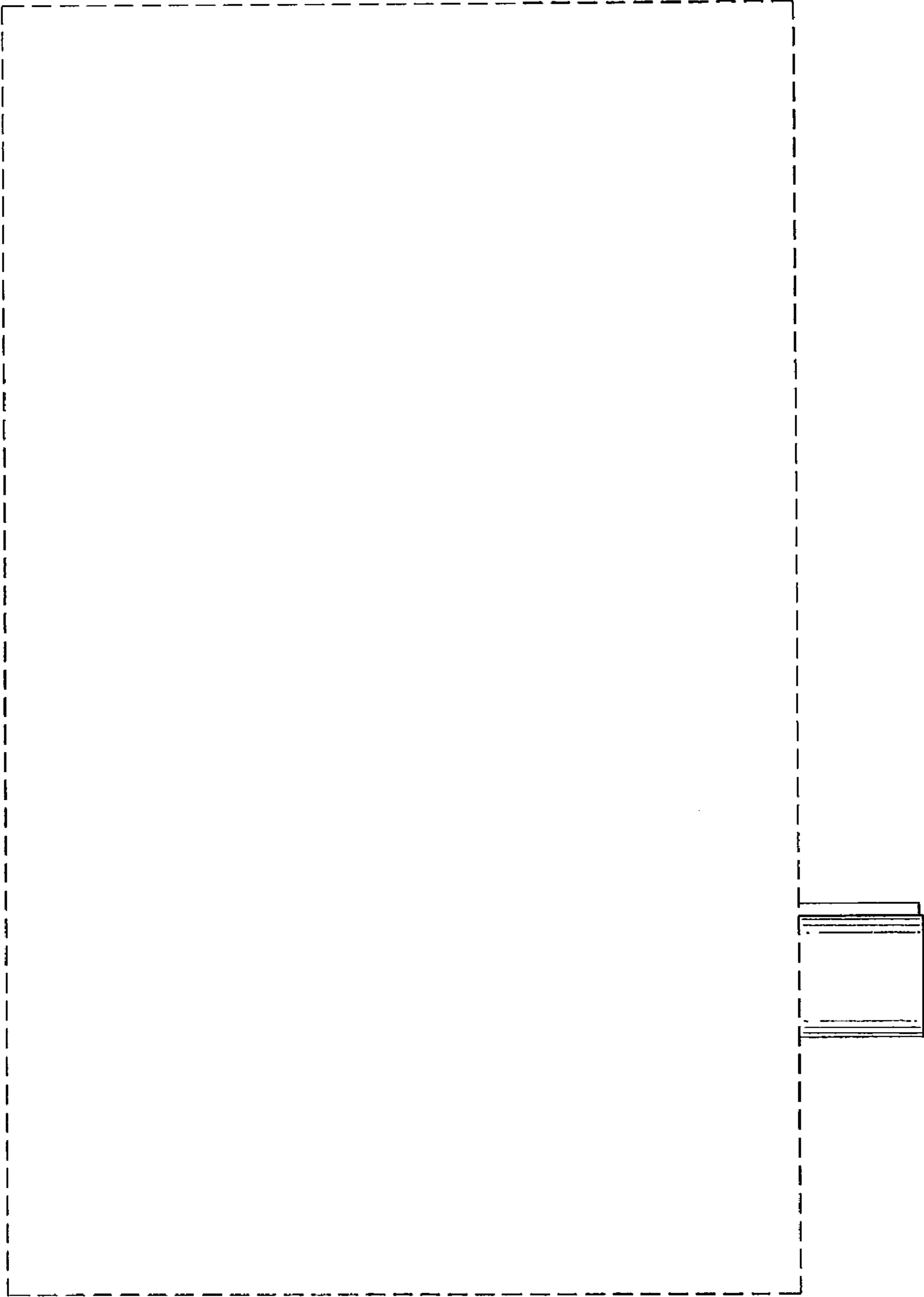

FIG. 12

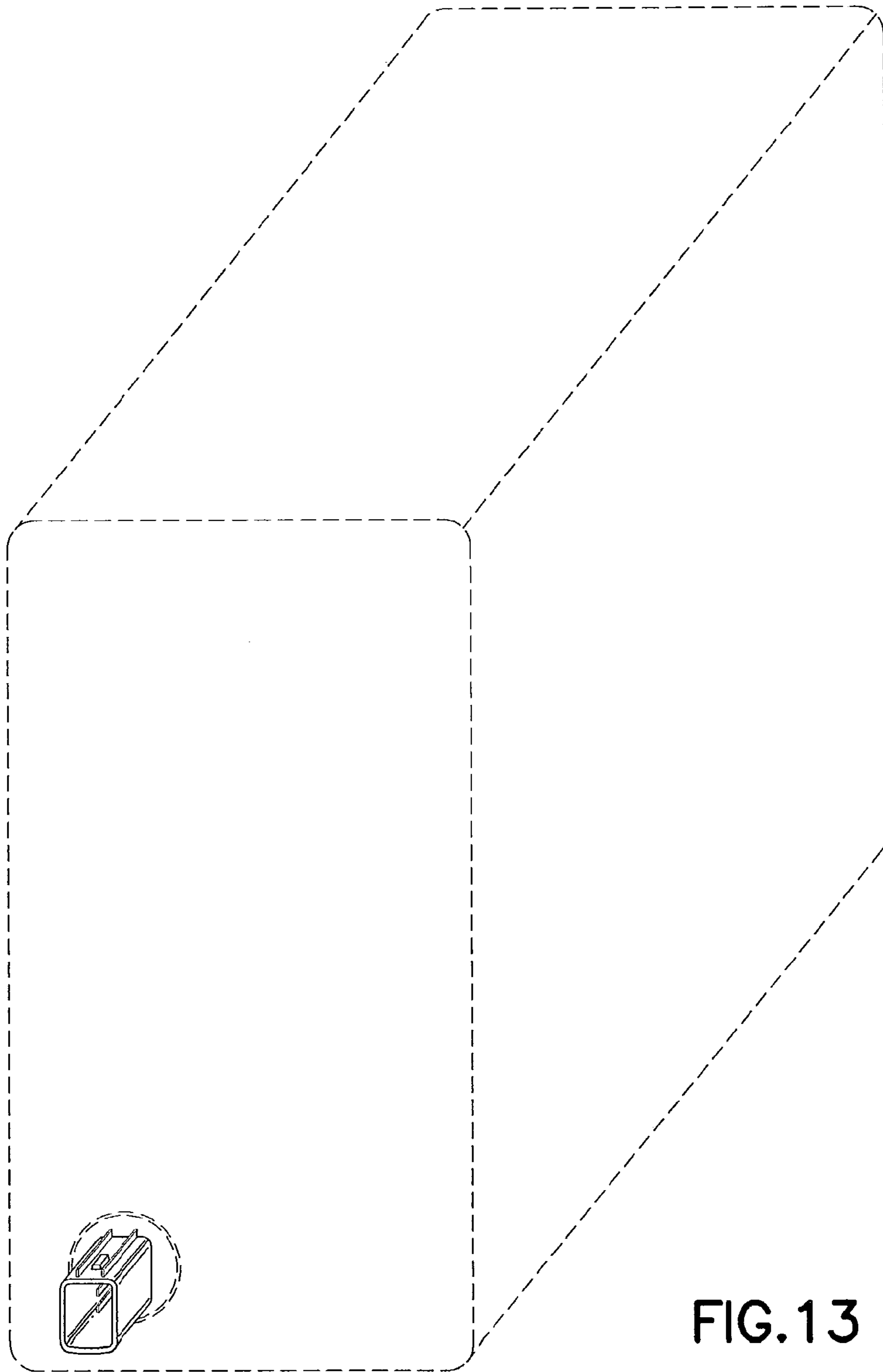

FIG. 13

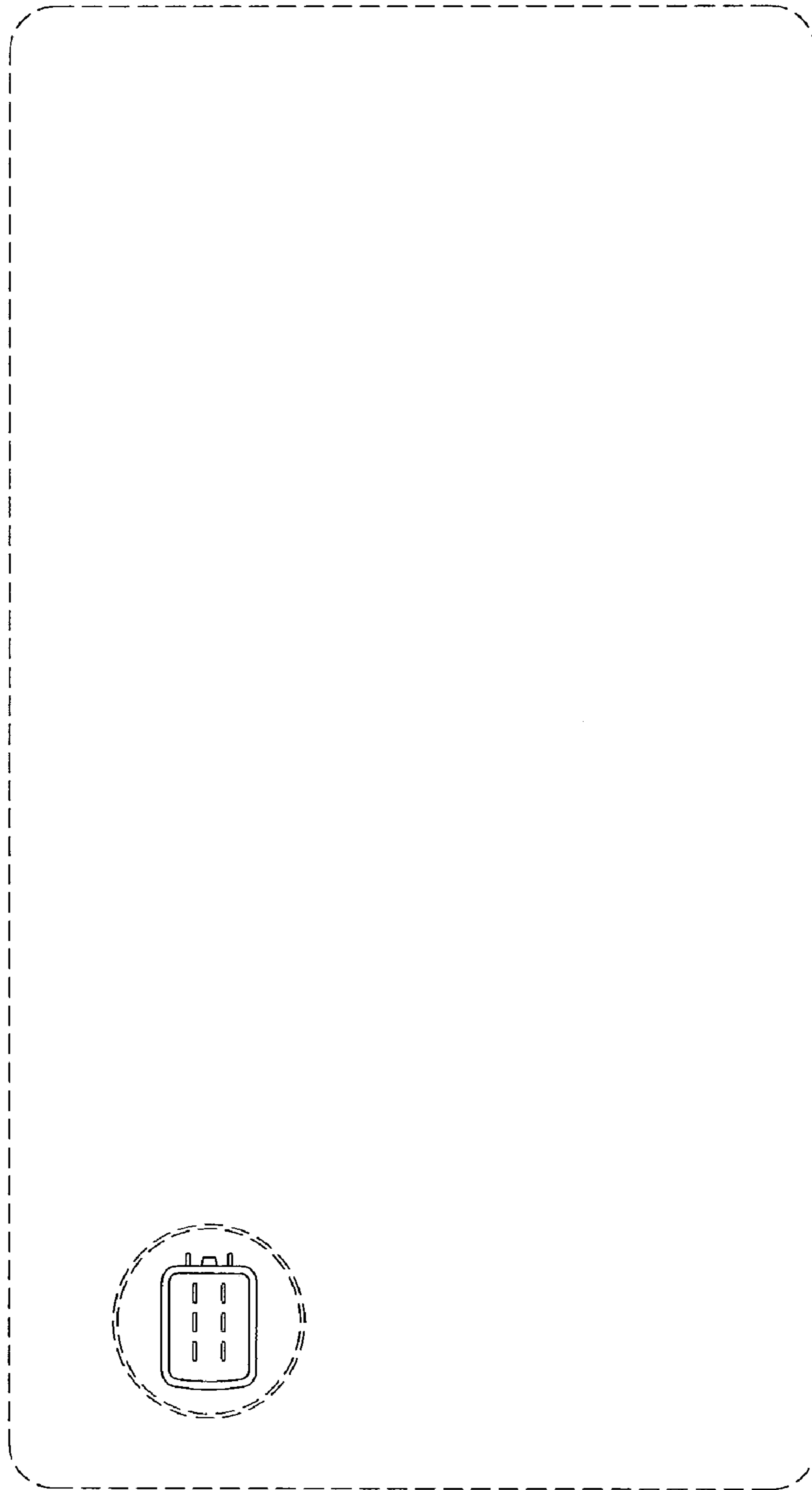

FIG. 14

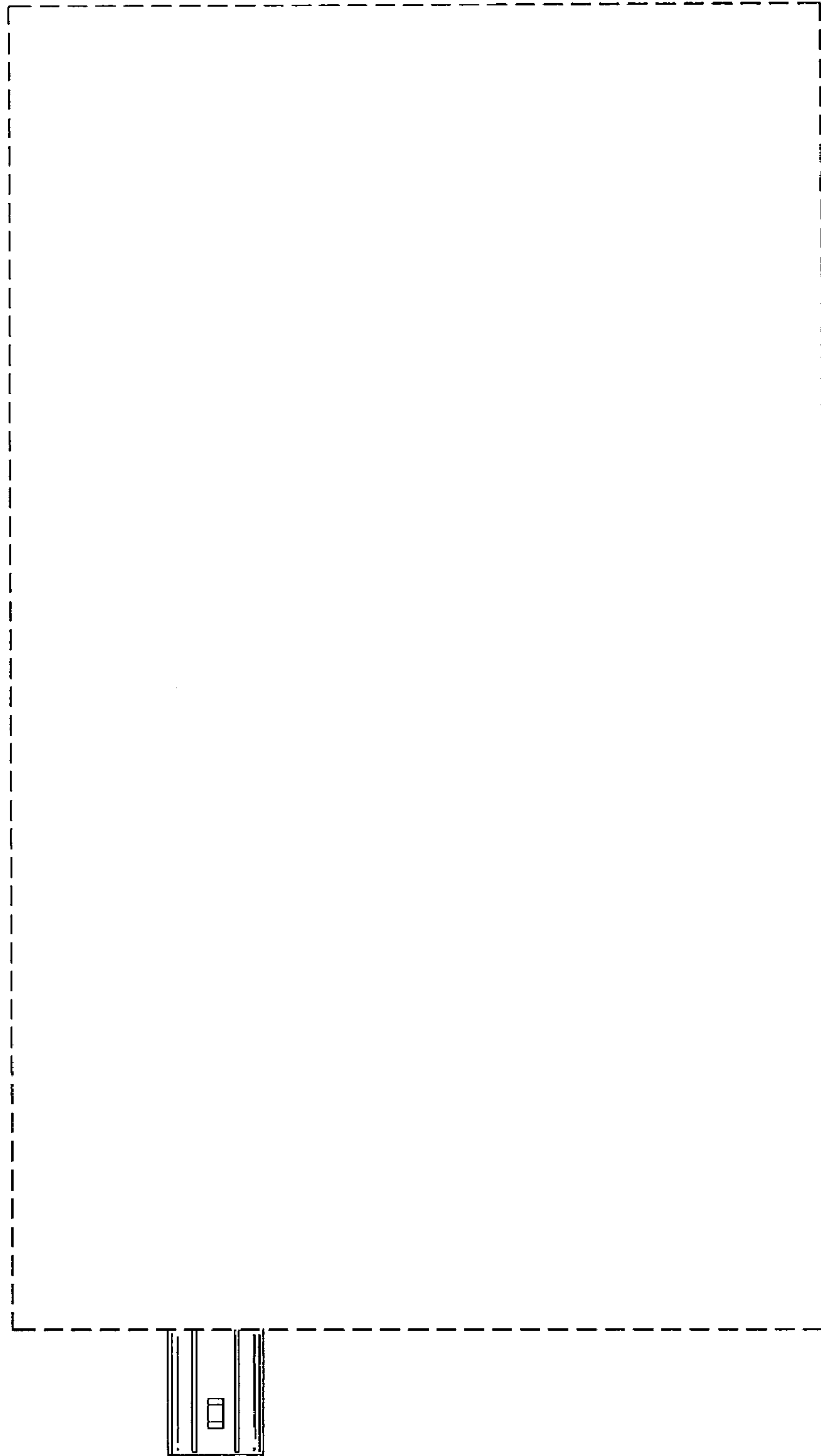

FIG. 15

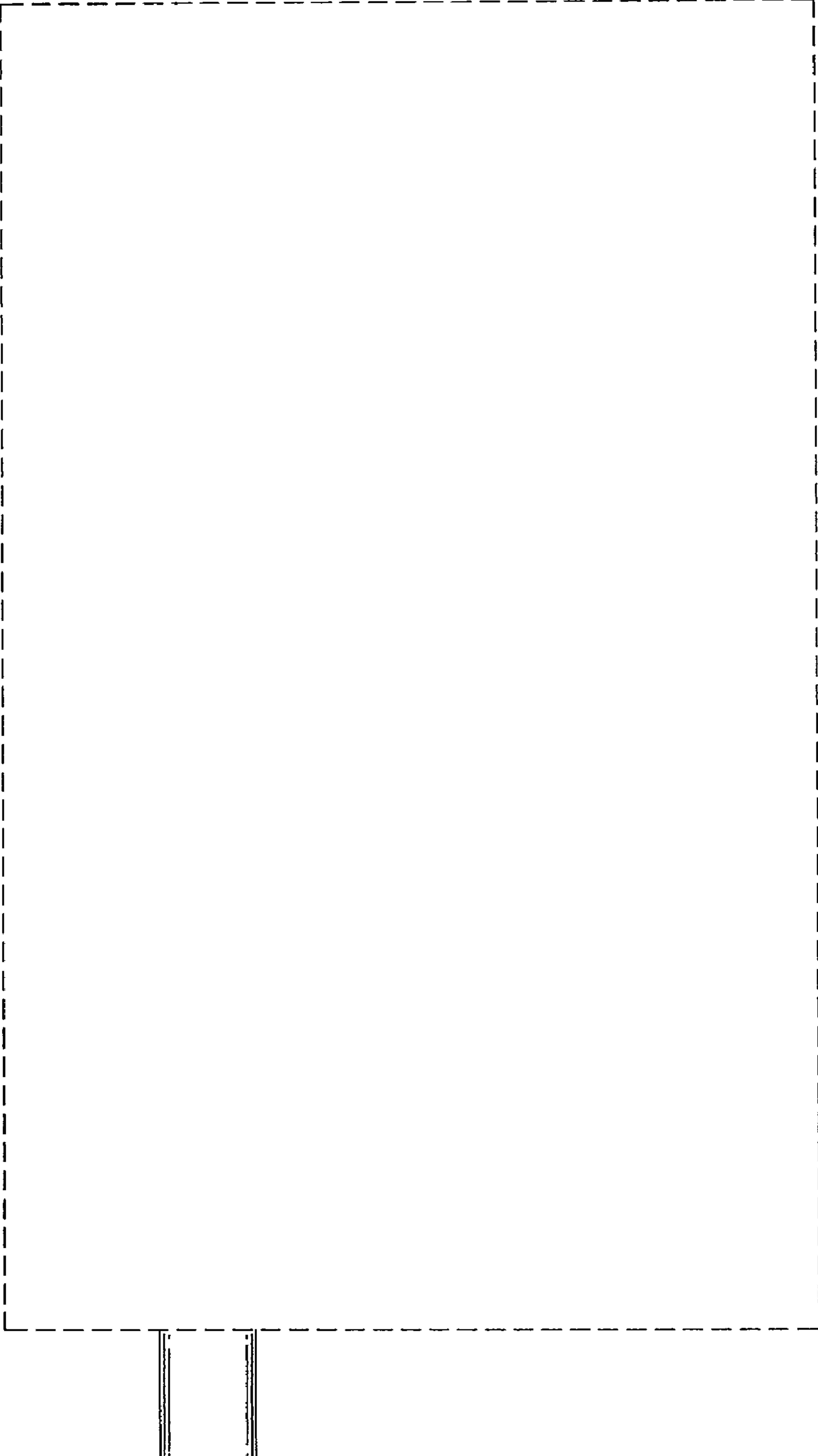

FIG. 16

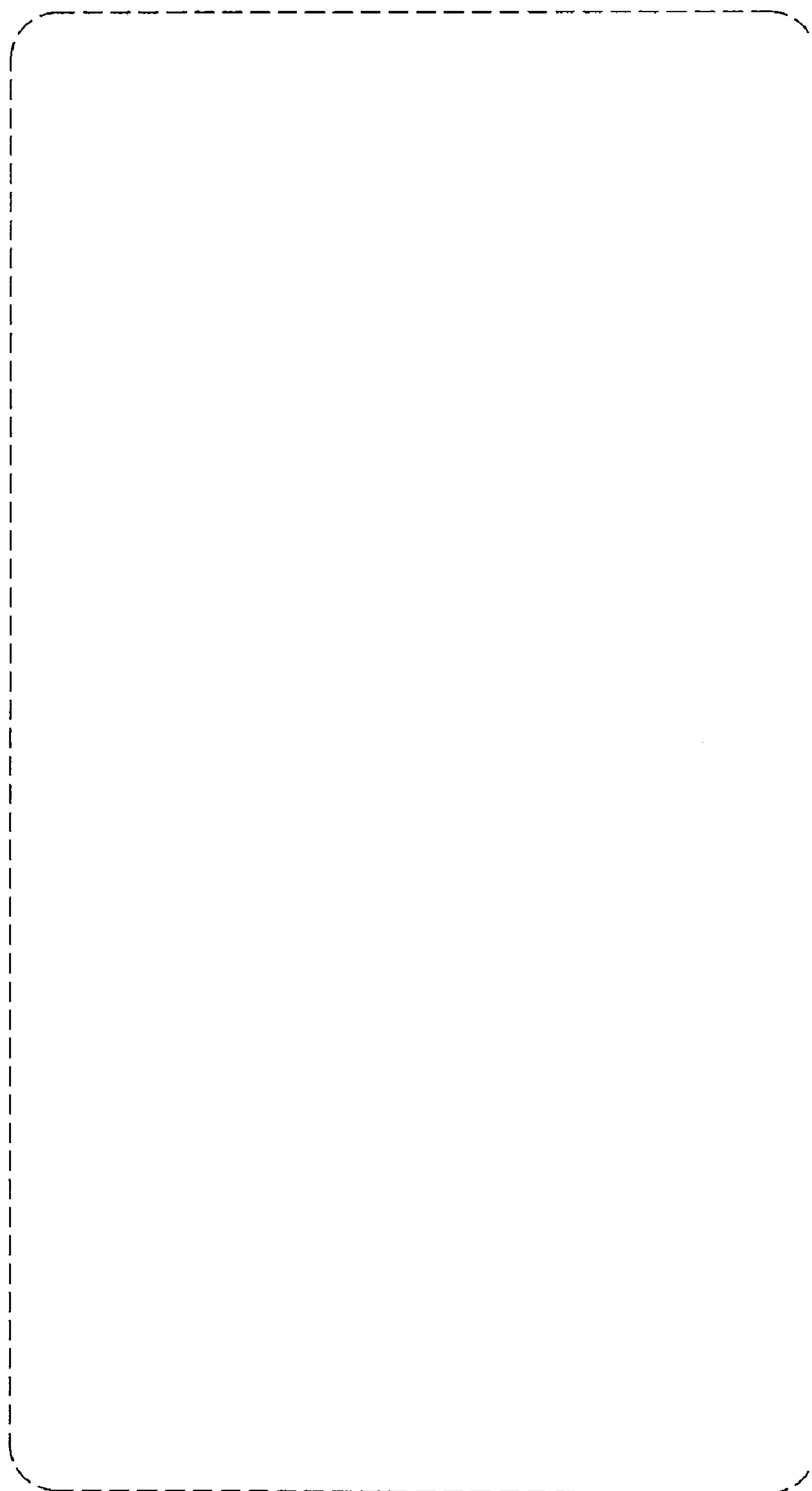

FIG.17

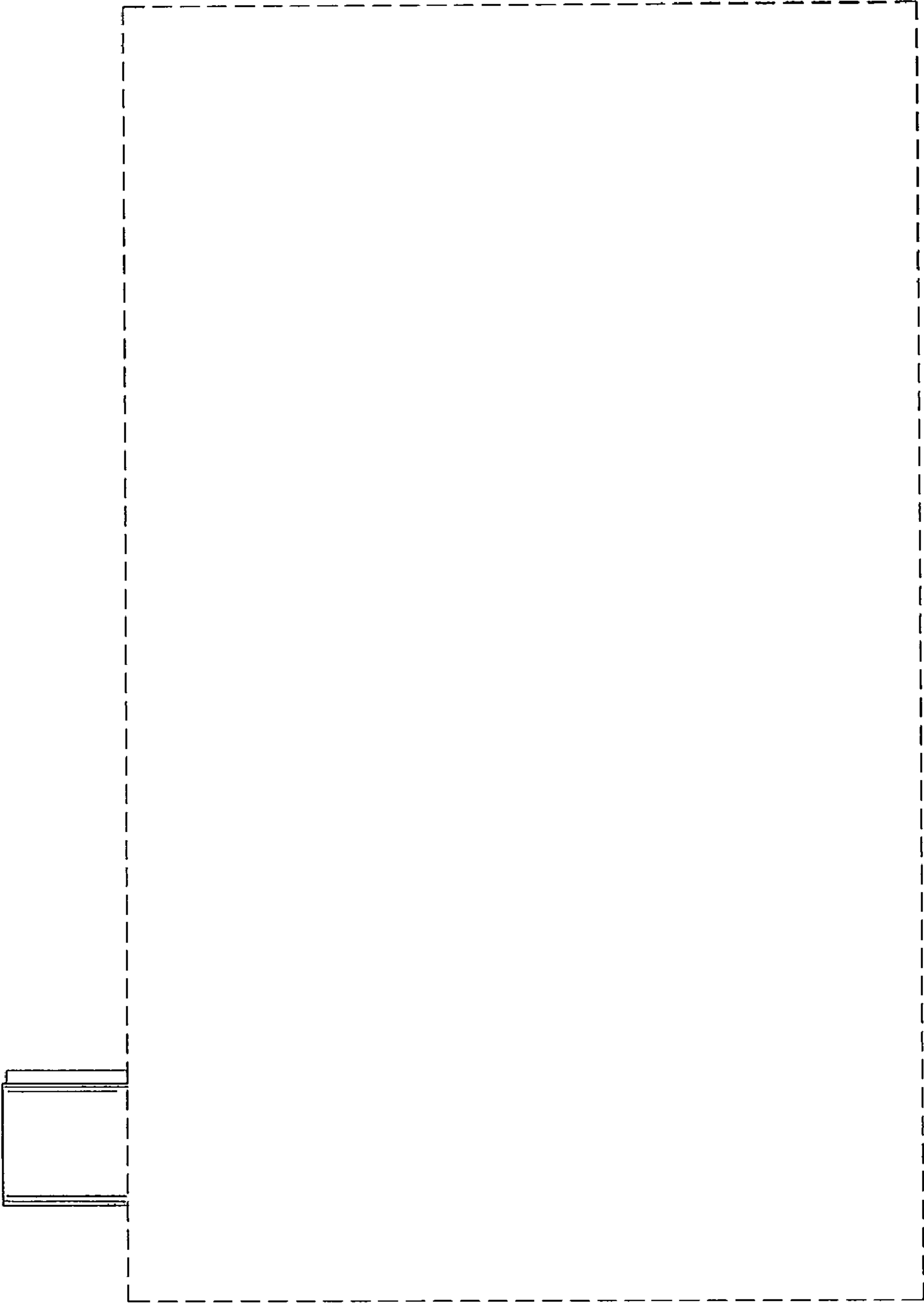

FIG.18

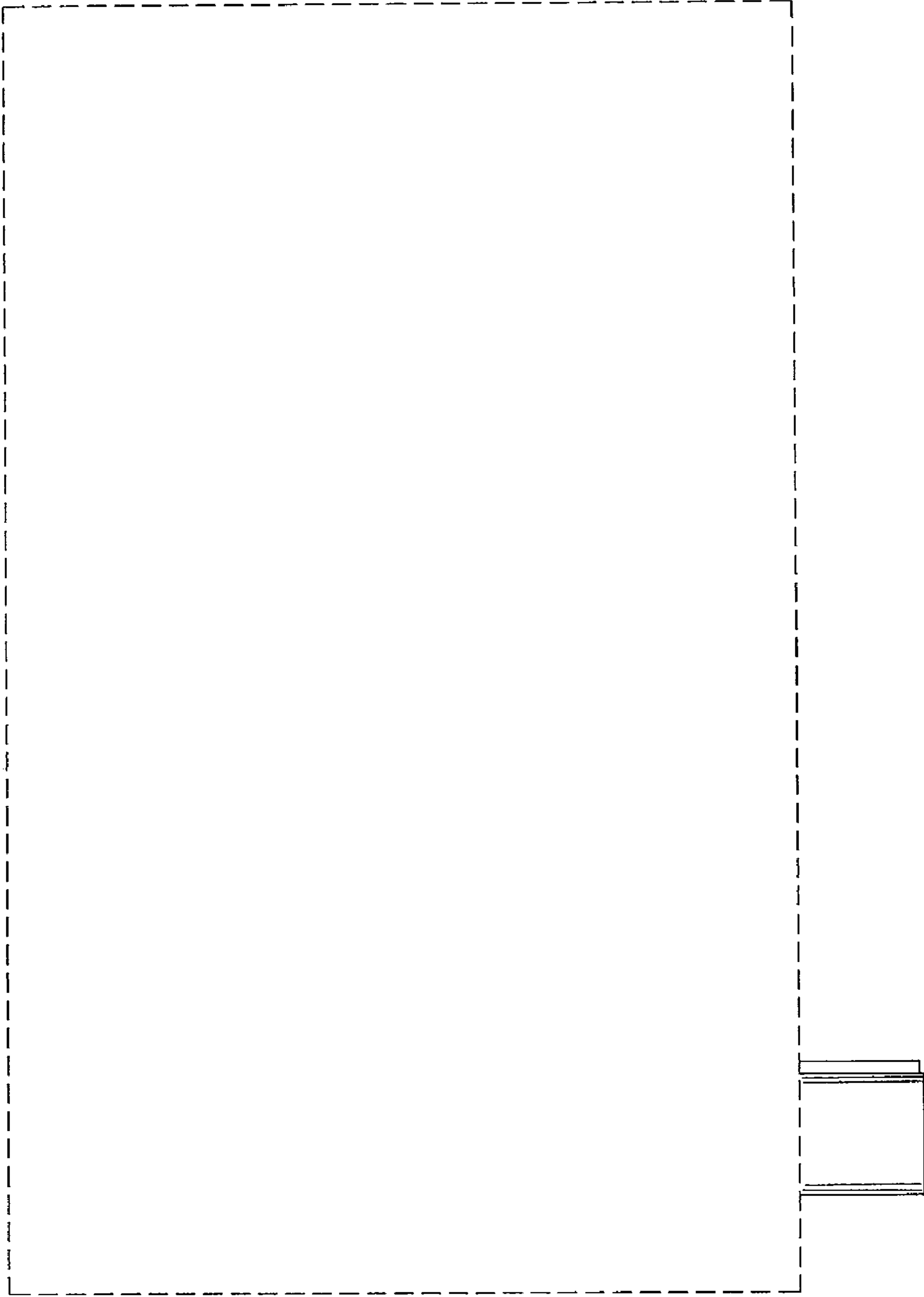

FIG. 19

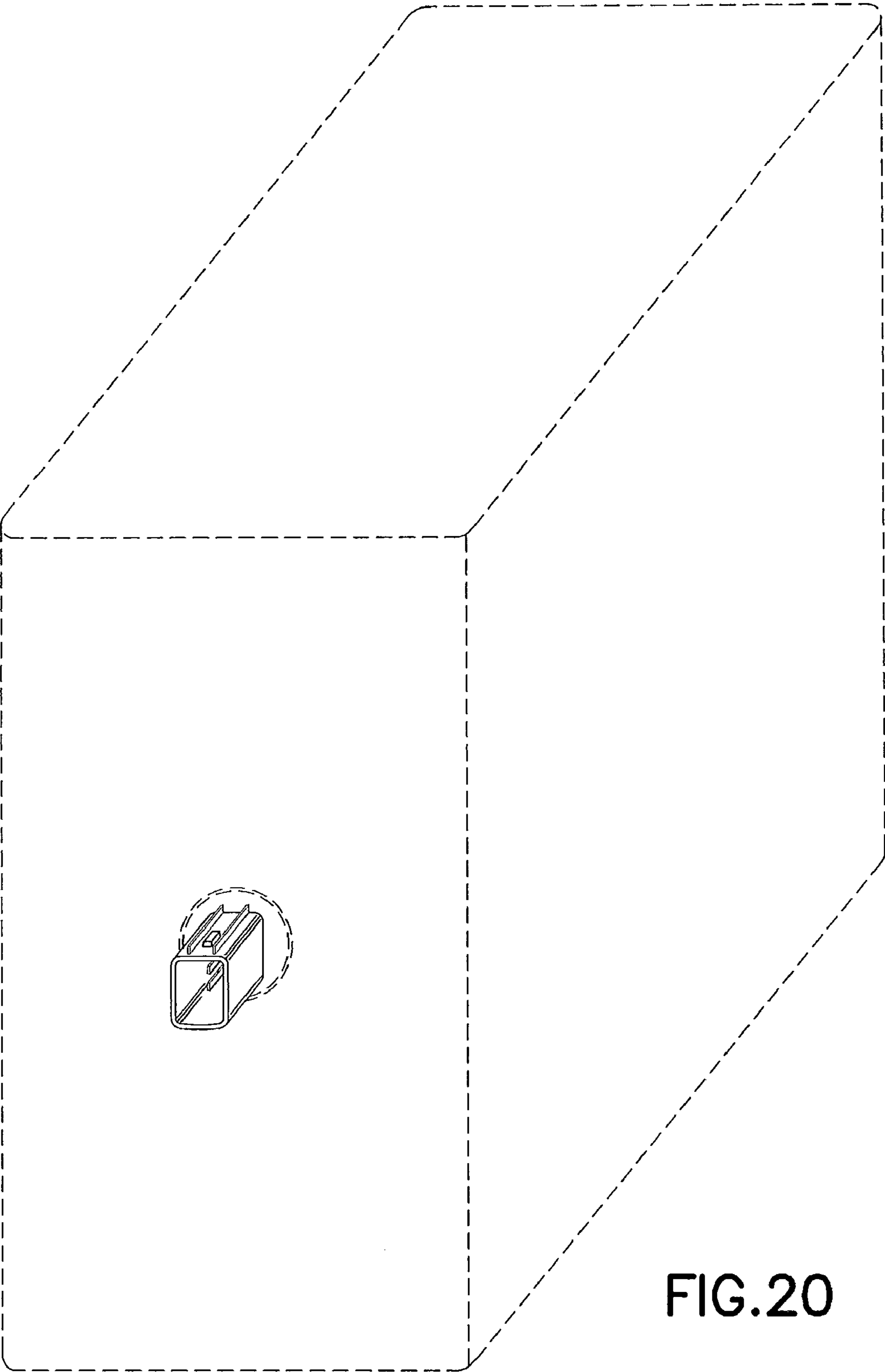

FIG.20

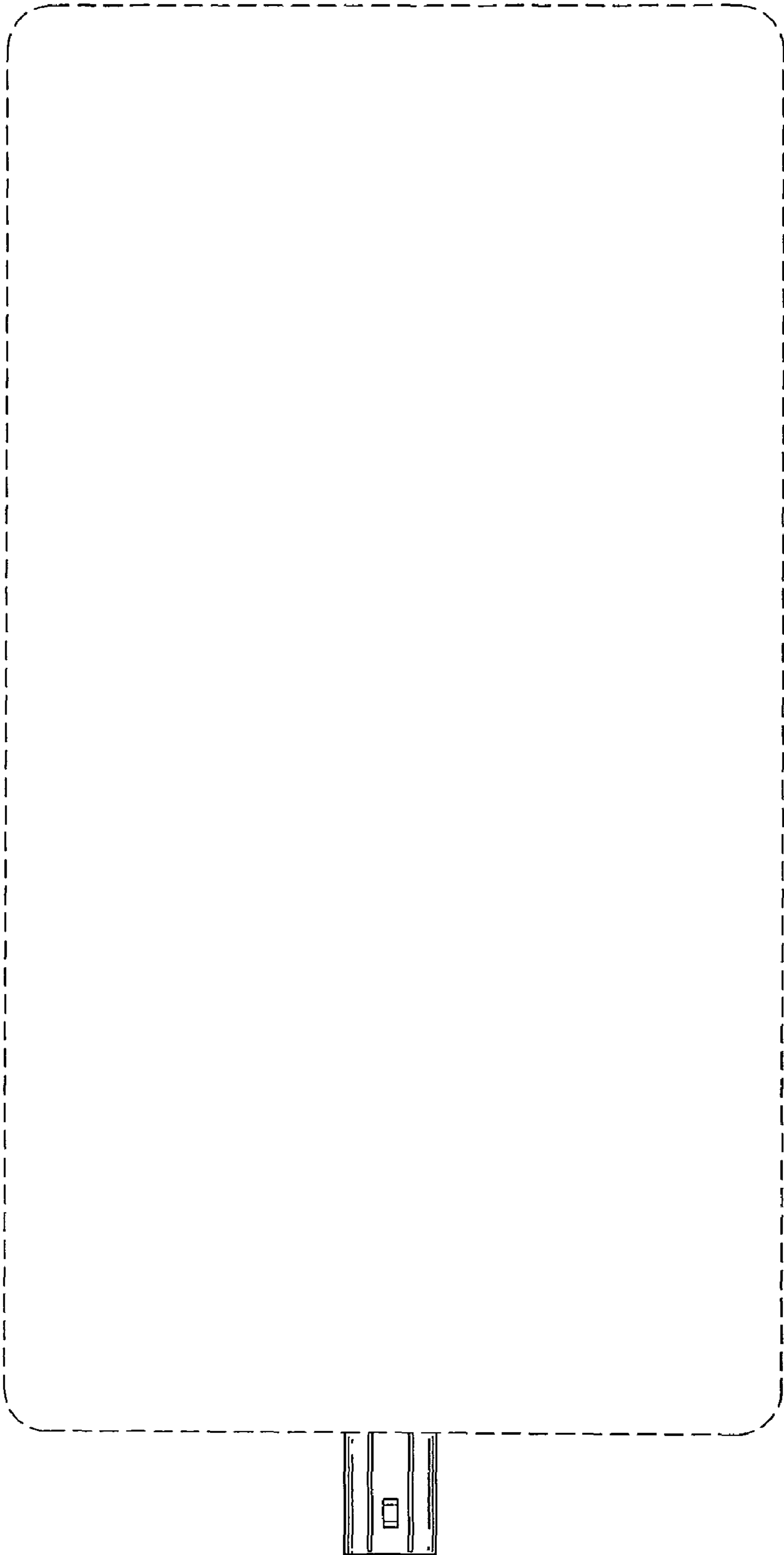

FIG.21

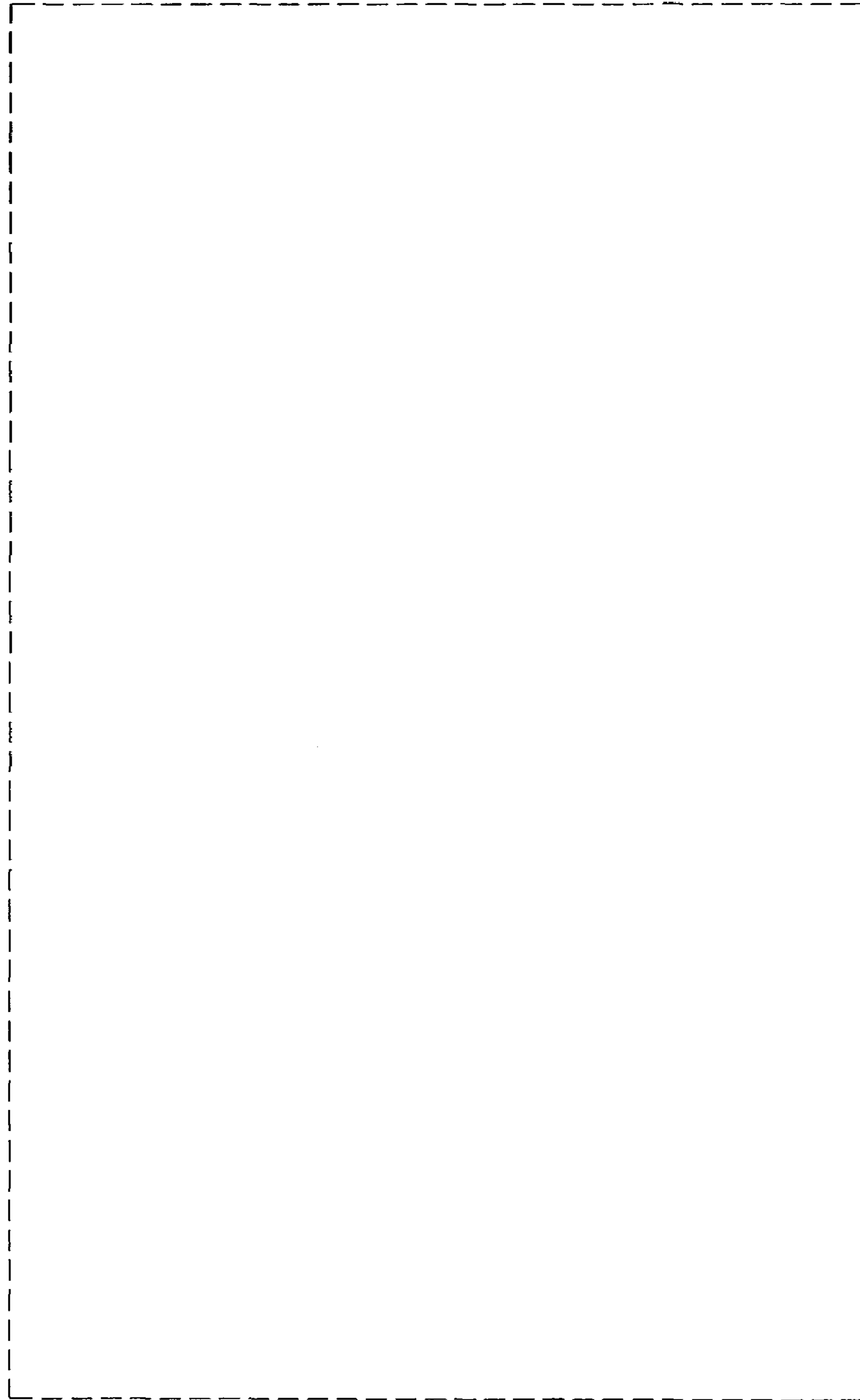

FIG. 22

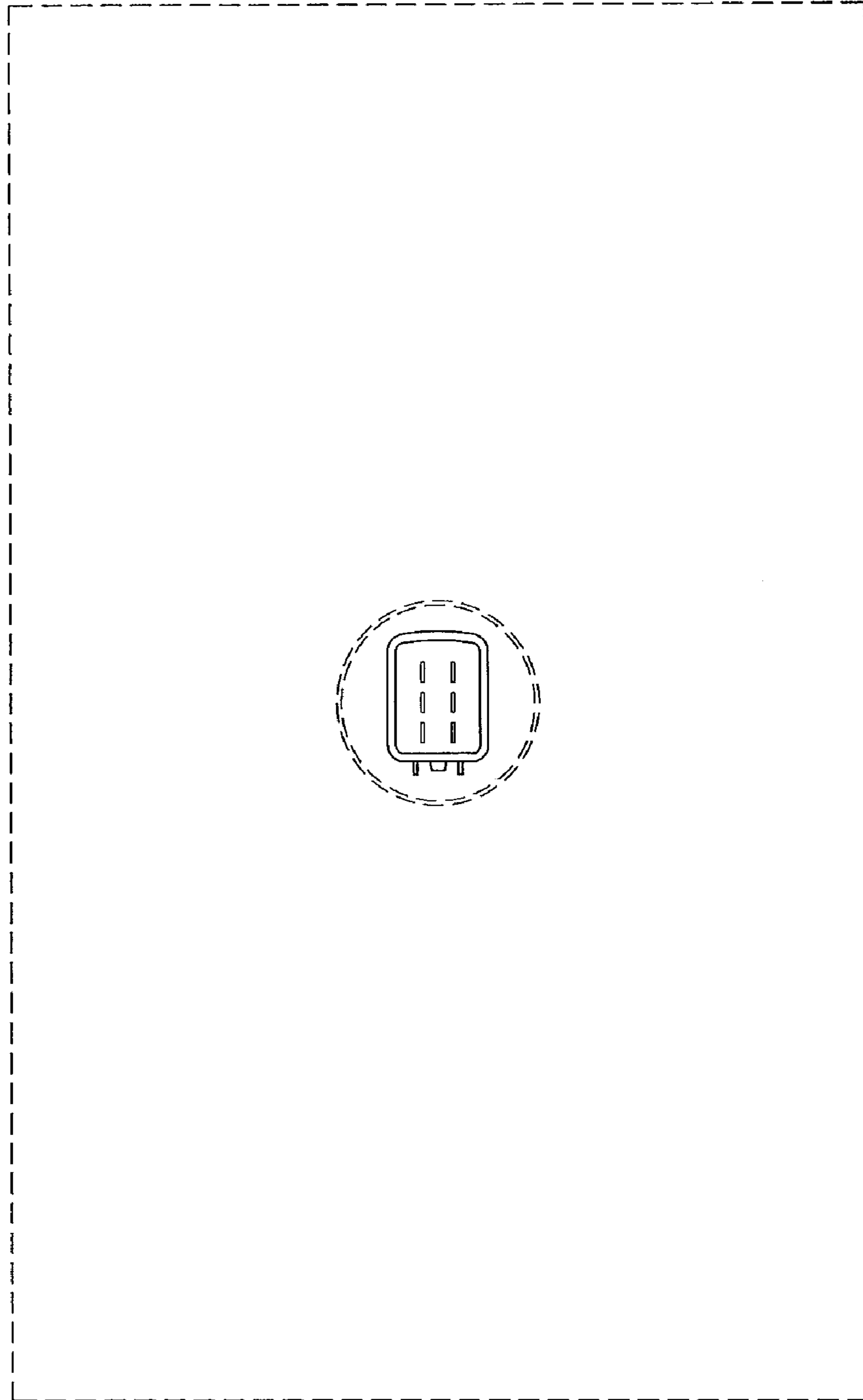

FIG. 23

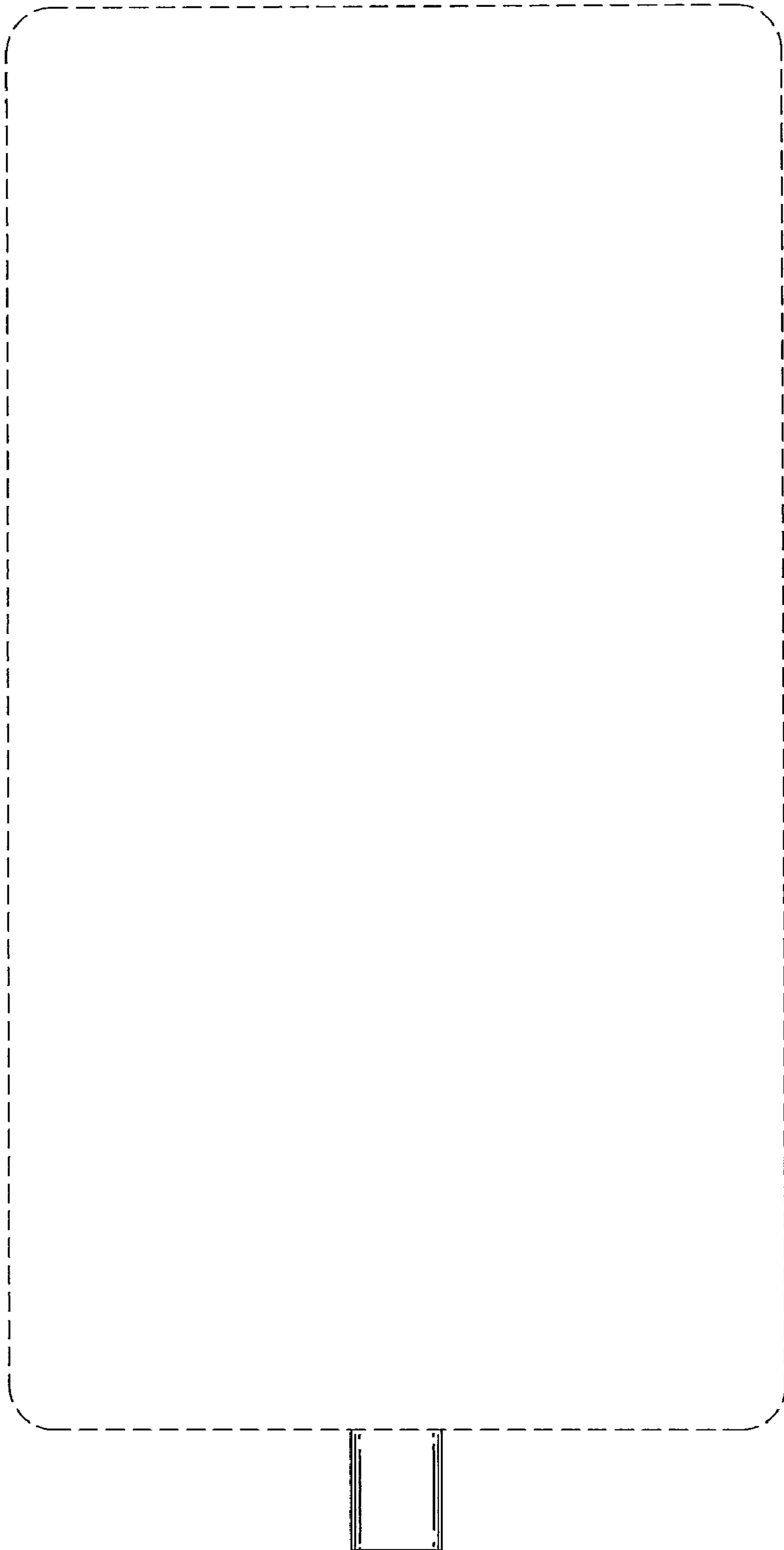

FIG.24

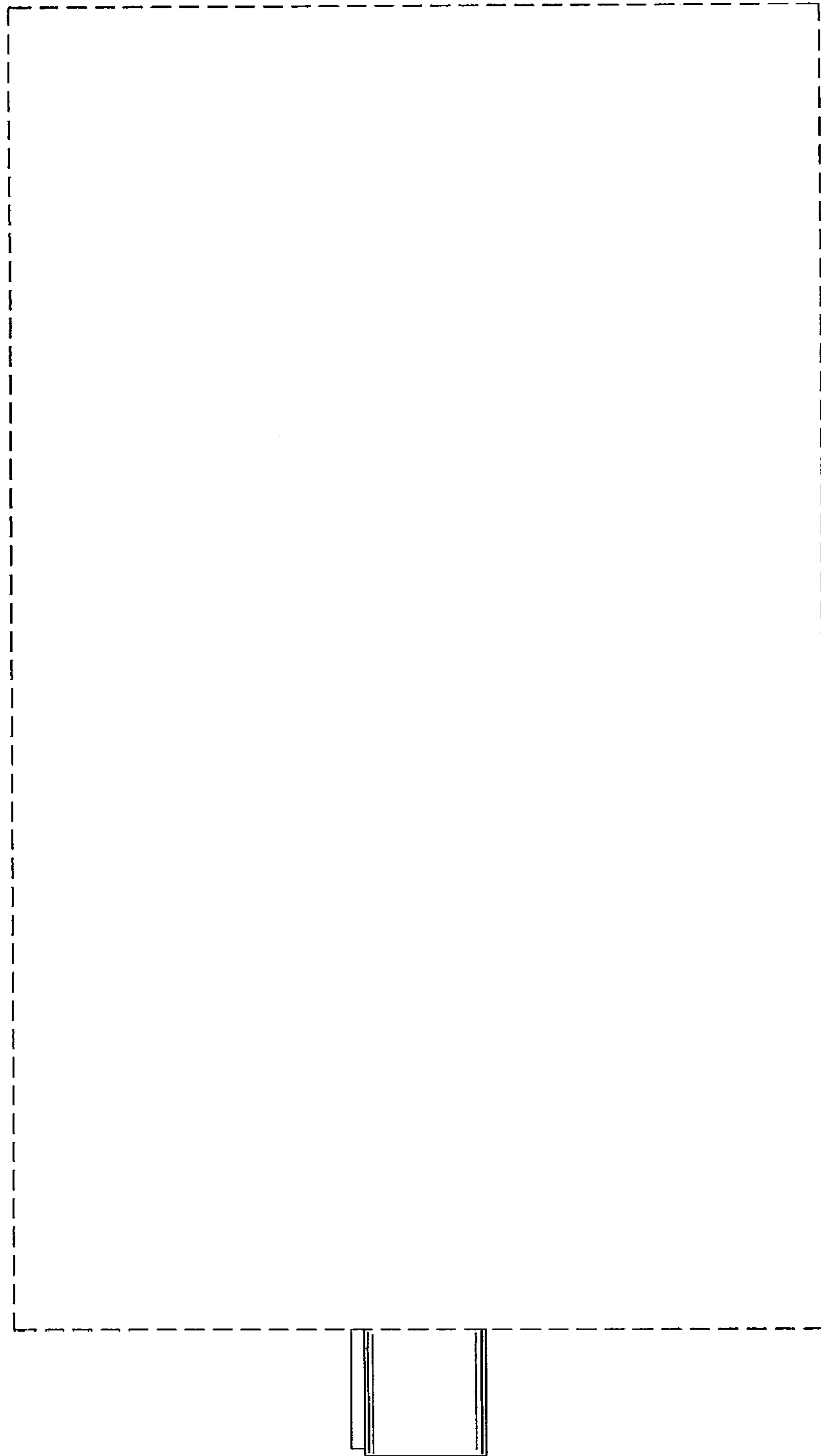

FIG.25

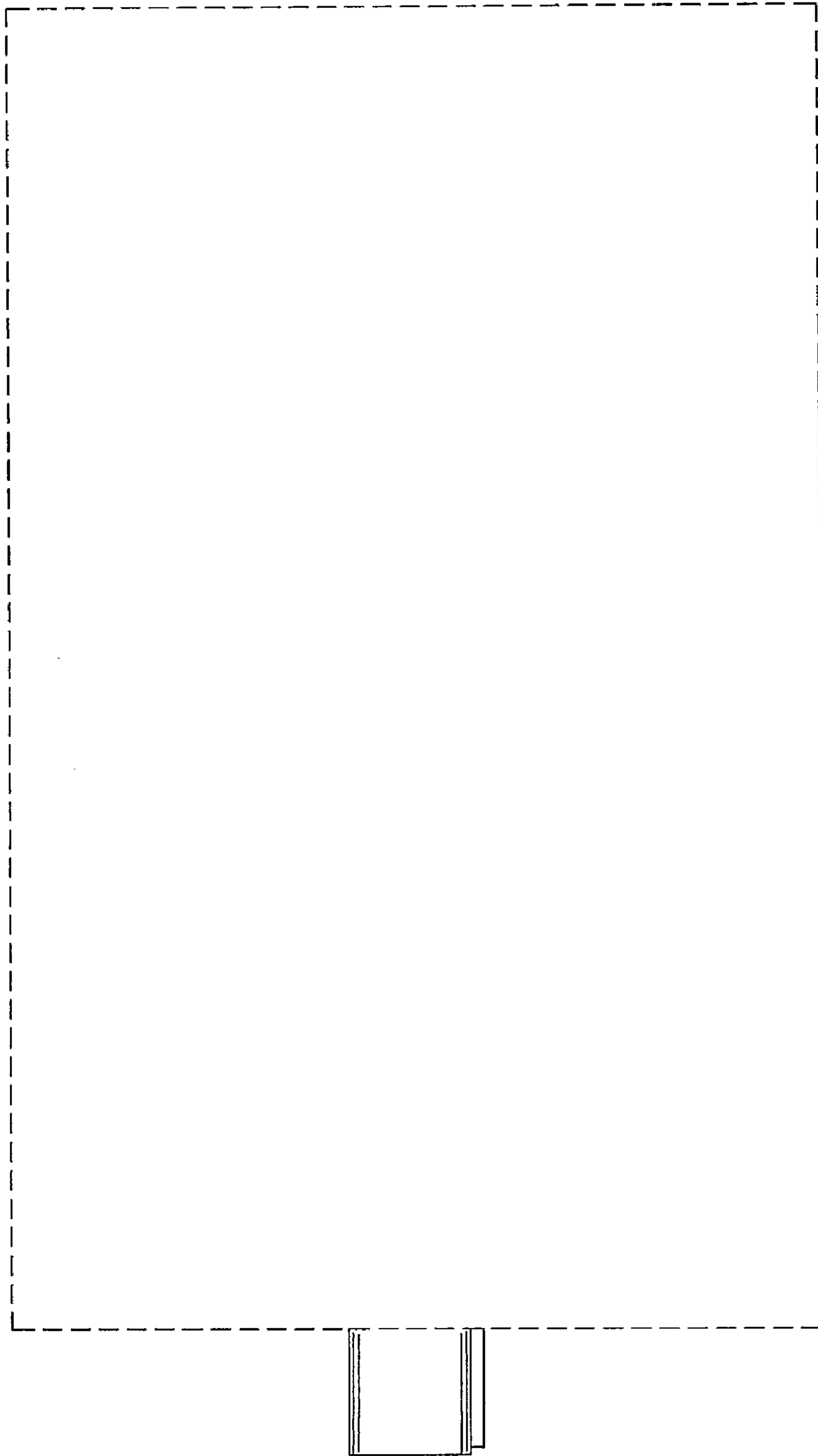

FIG.26

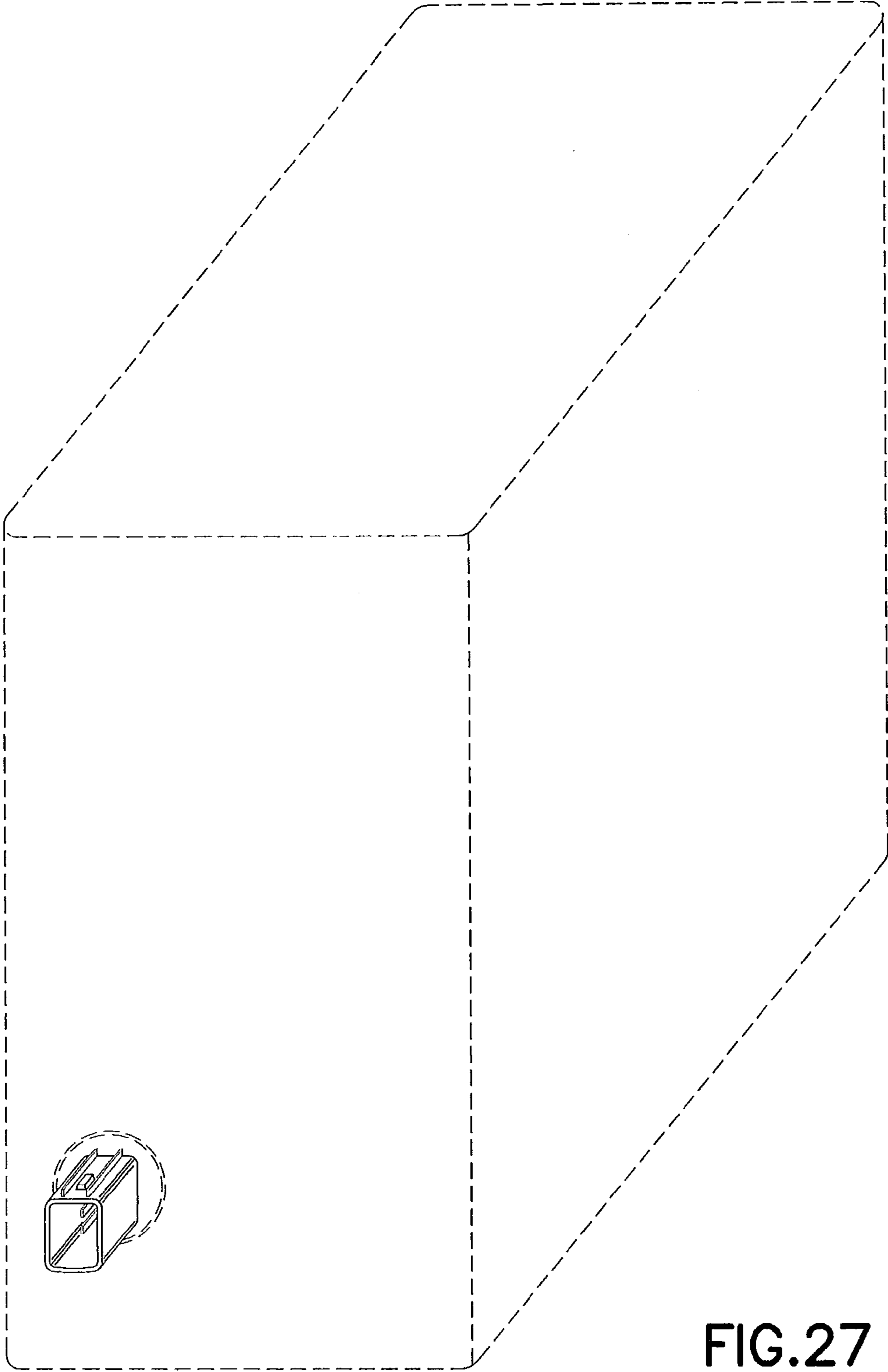

FIG.27

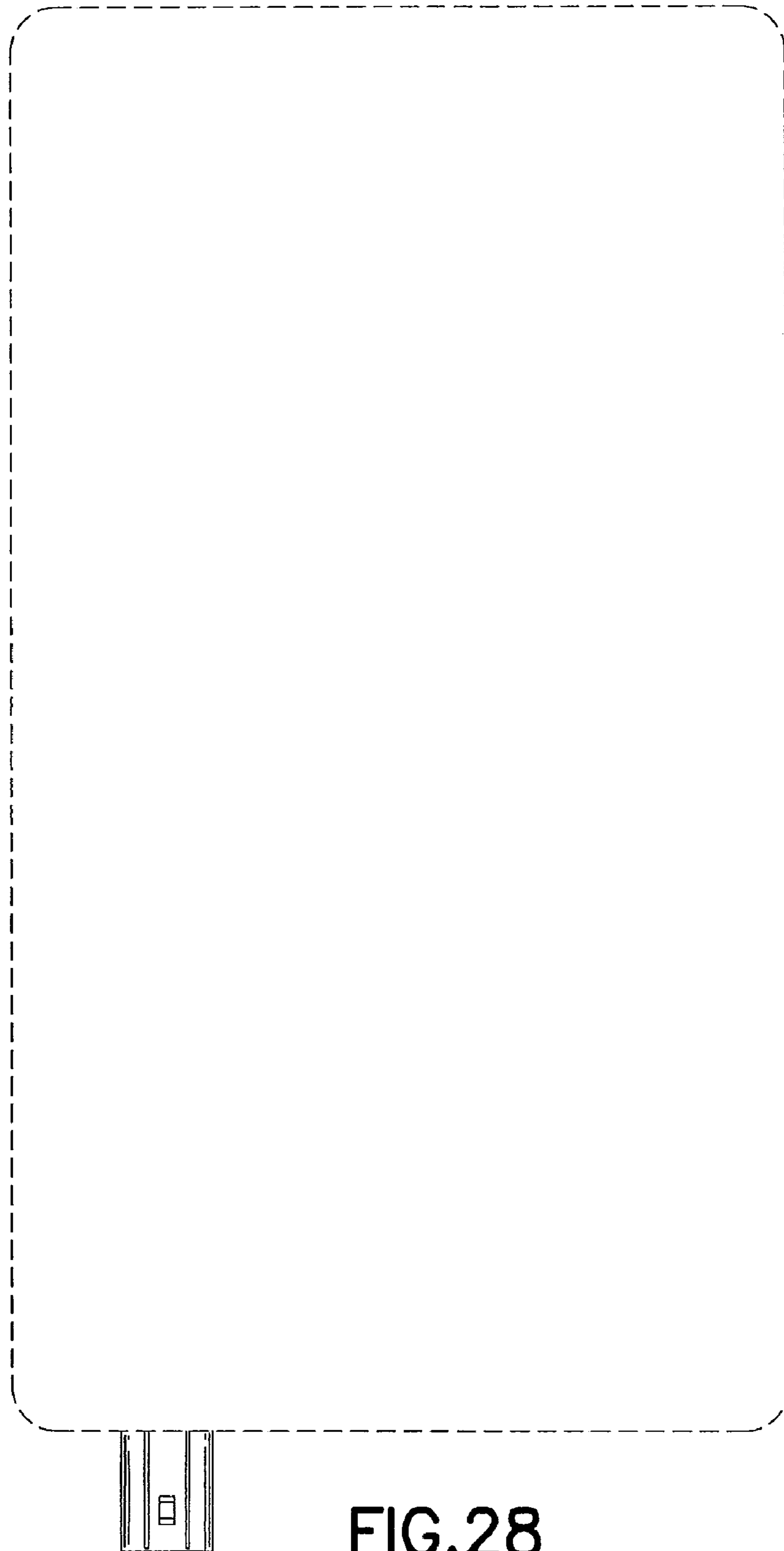

FIG. 28

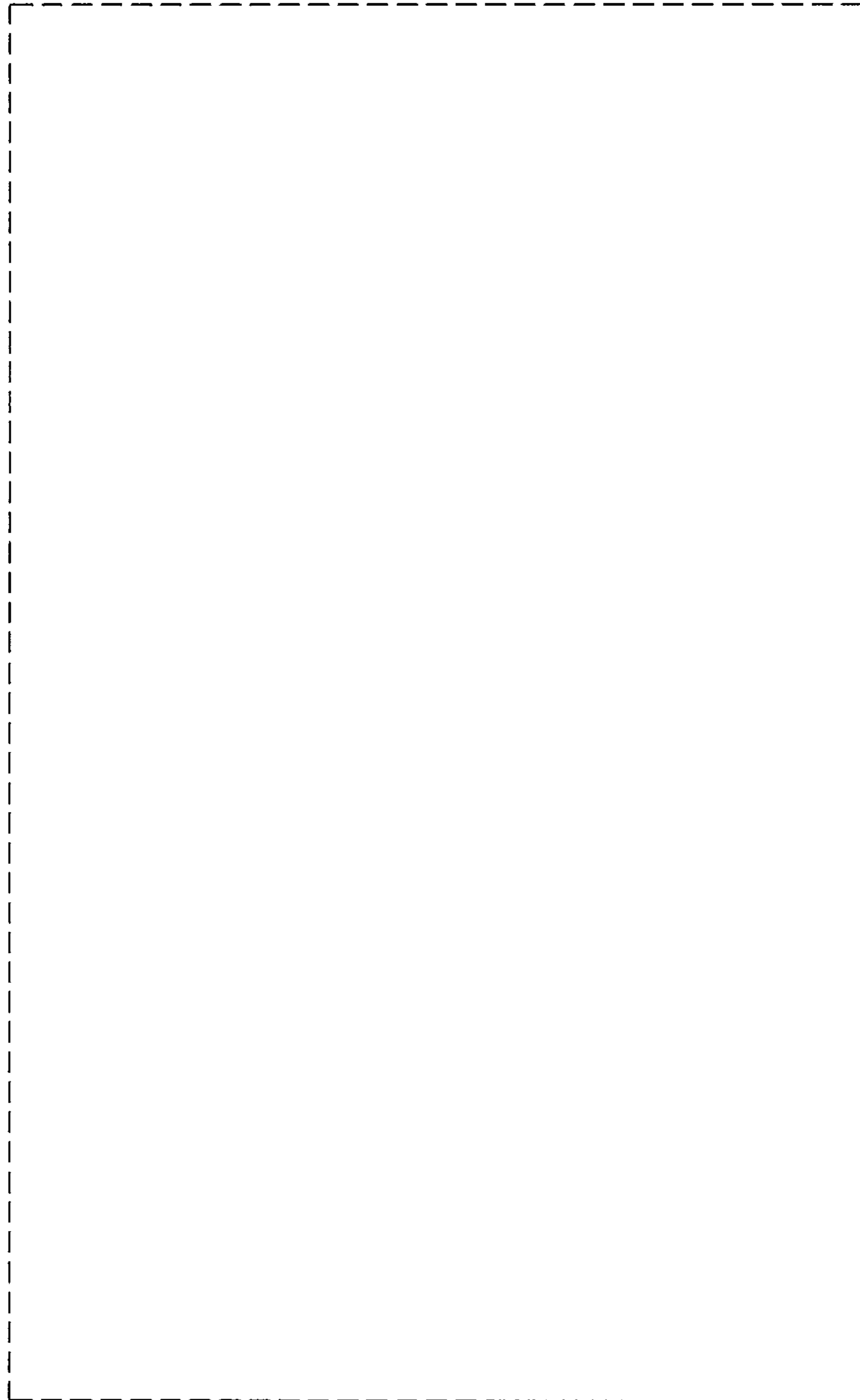

FIG.29

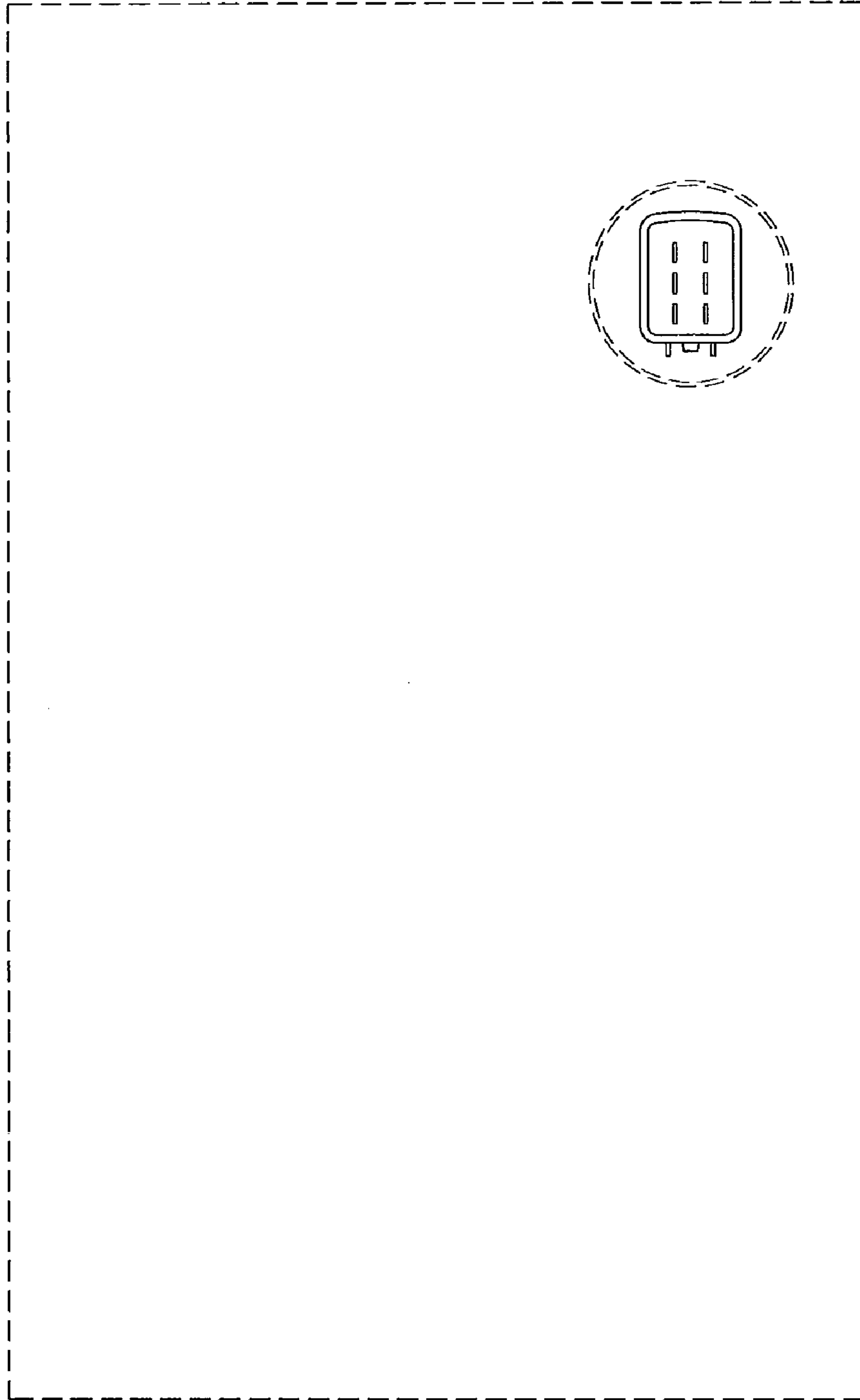

FIG. 30

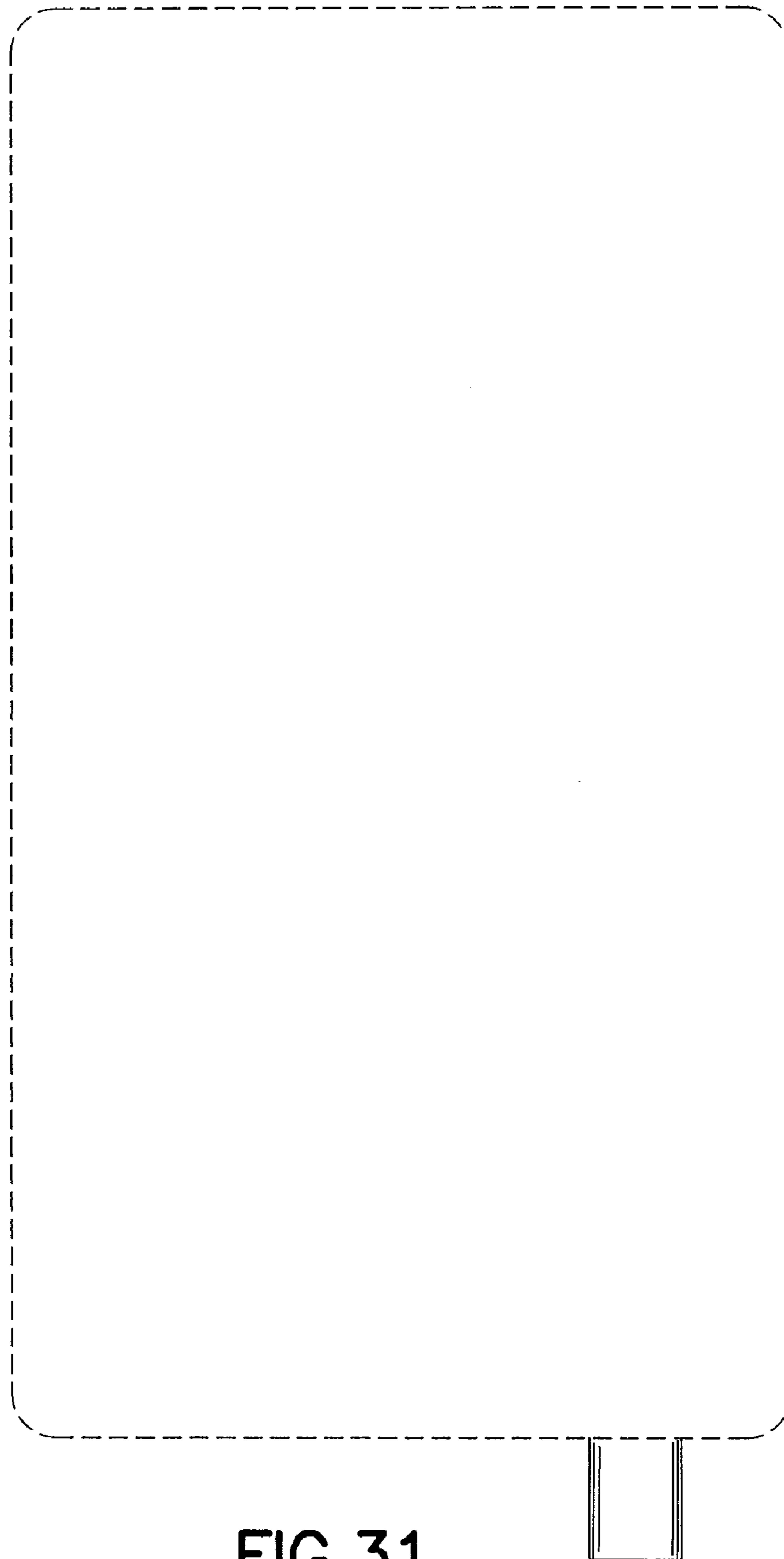

FIG. 31

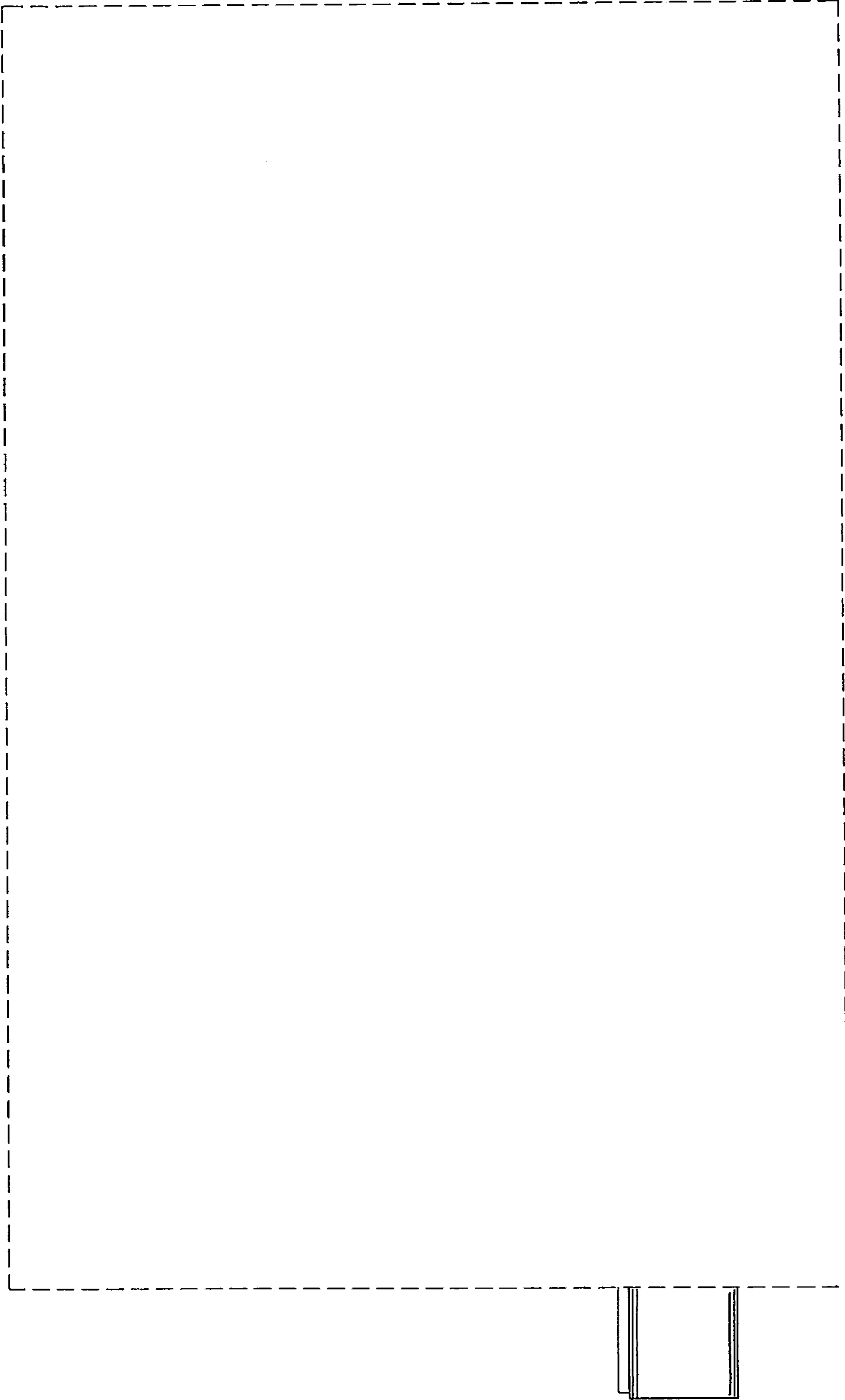

FIG.32

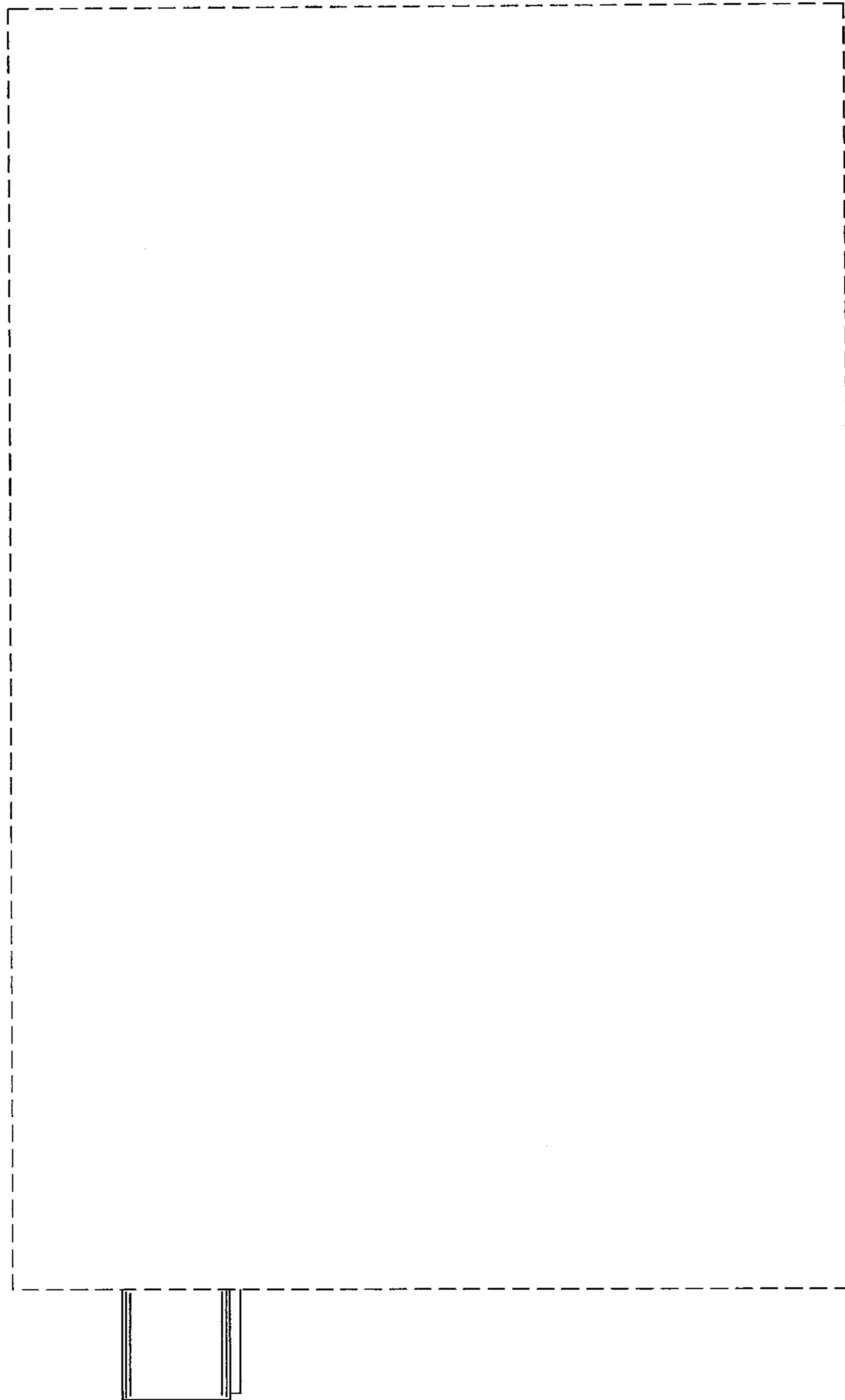

FIG.33

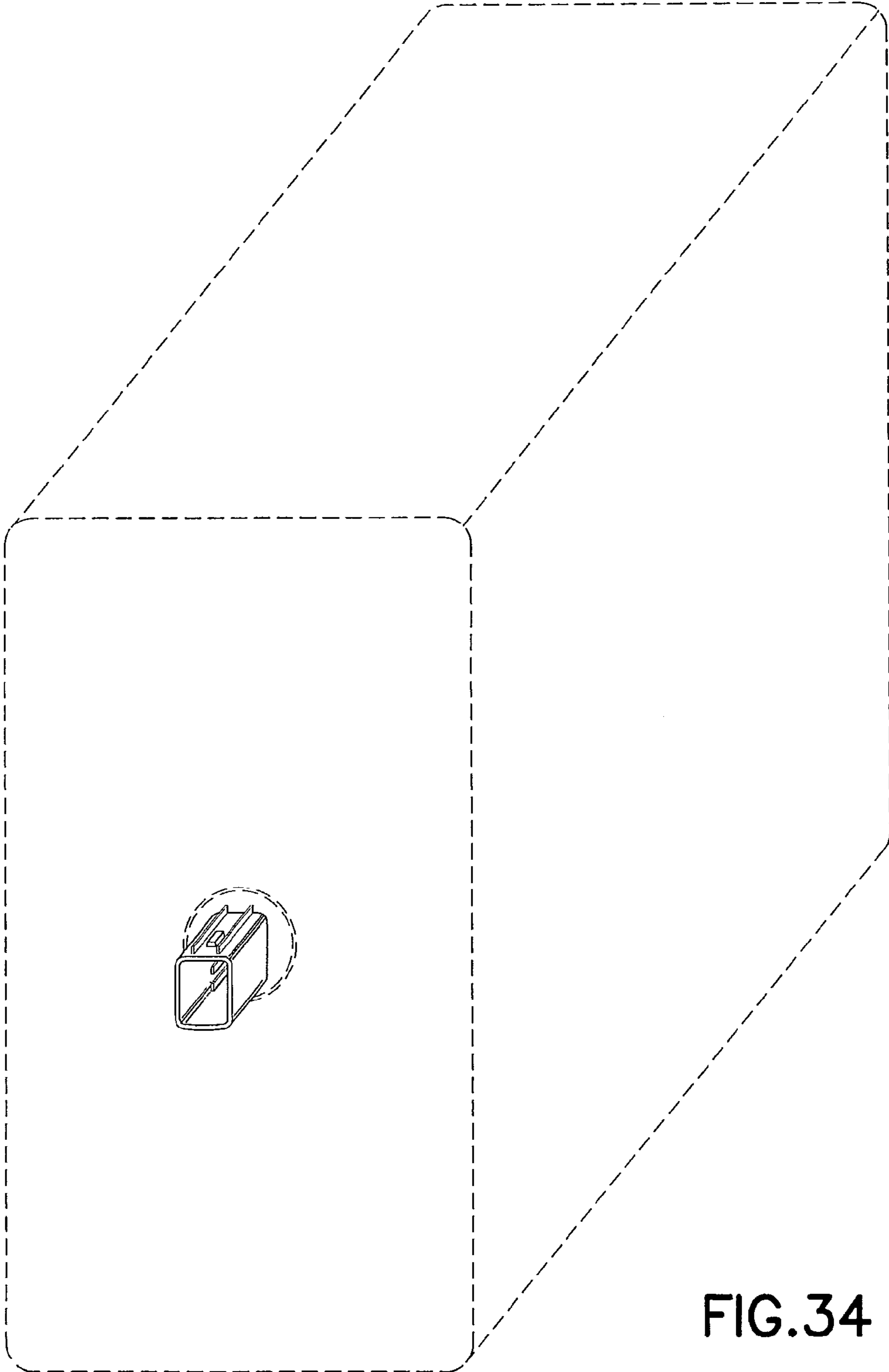

FIG.34

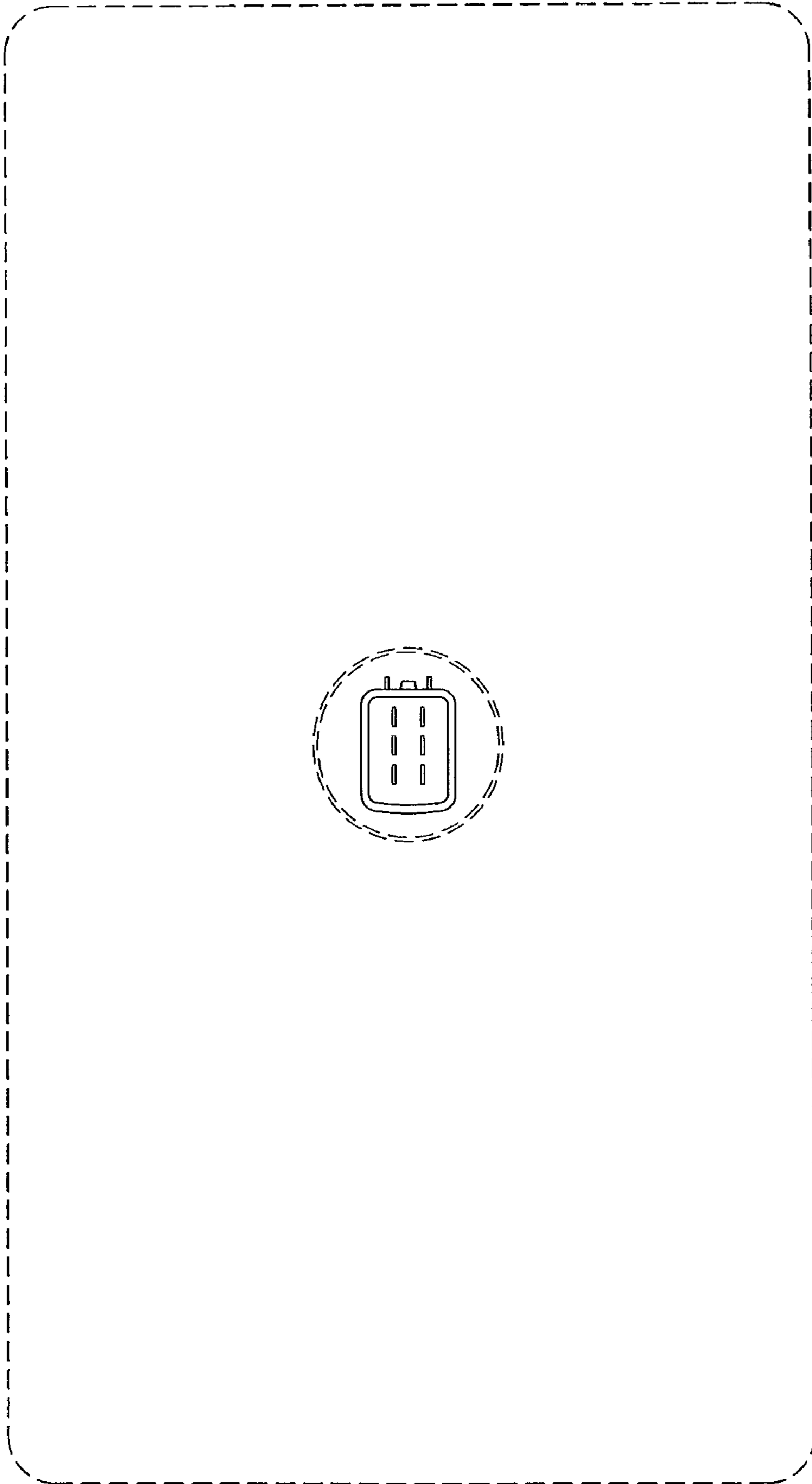

FIG.35

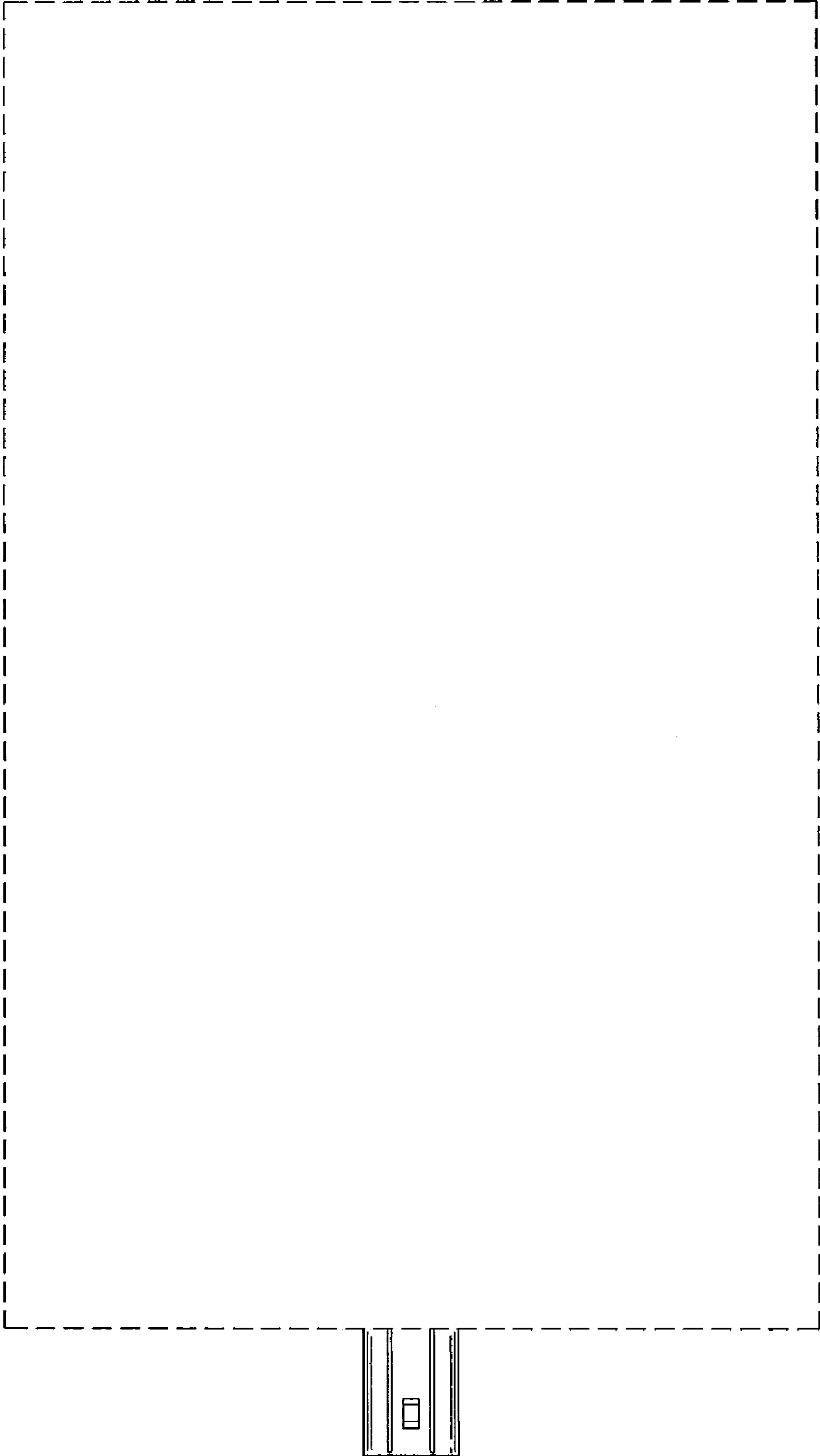

FIG.36

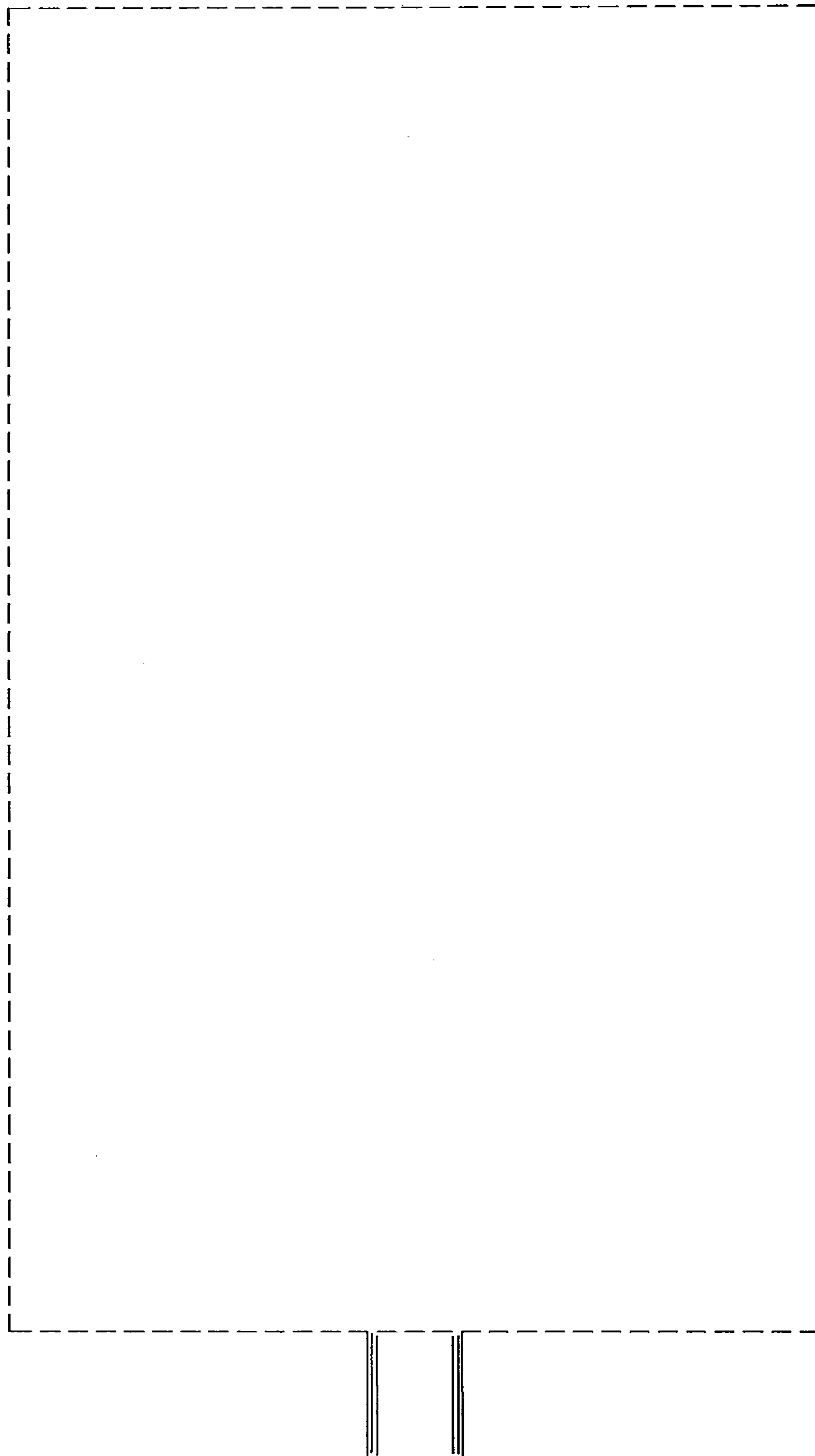

FIG. 37

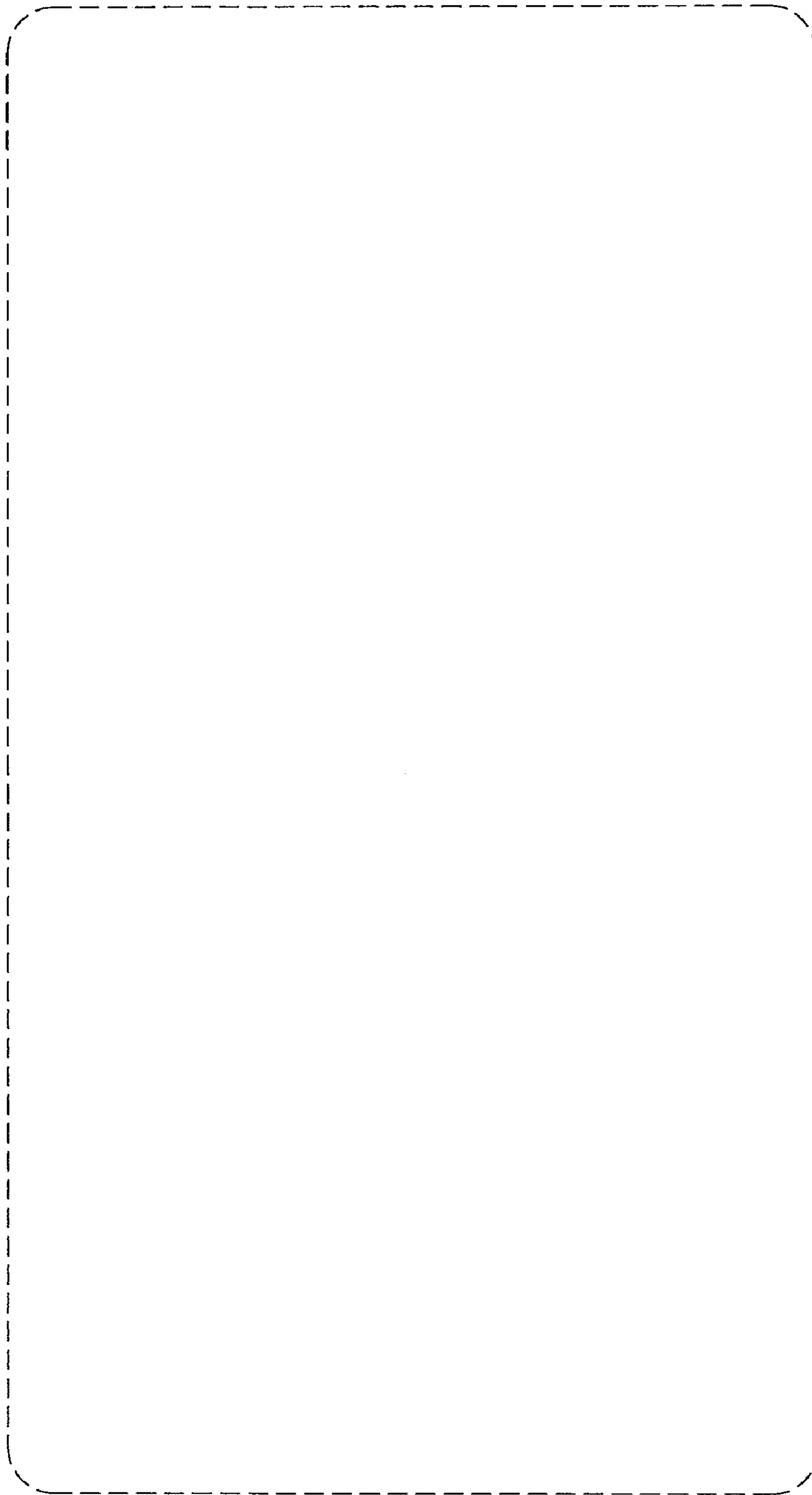

FIG.38

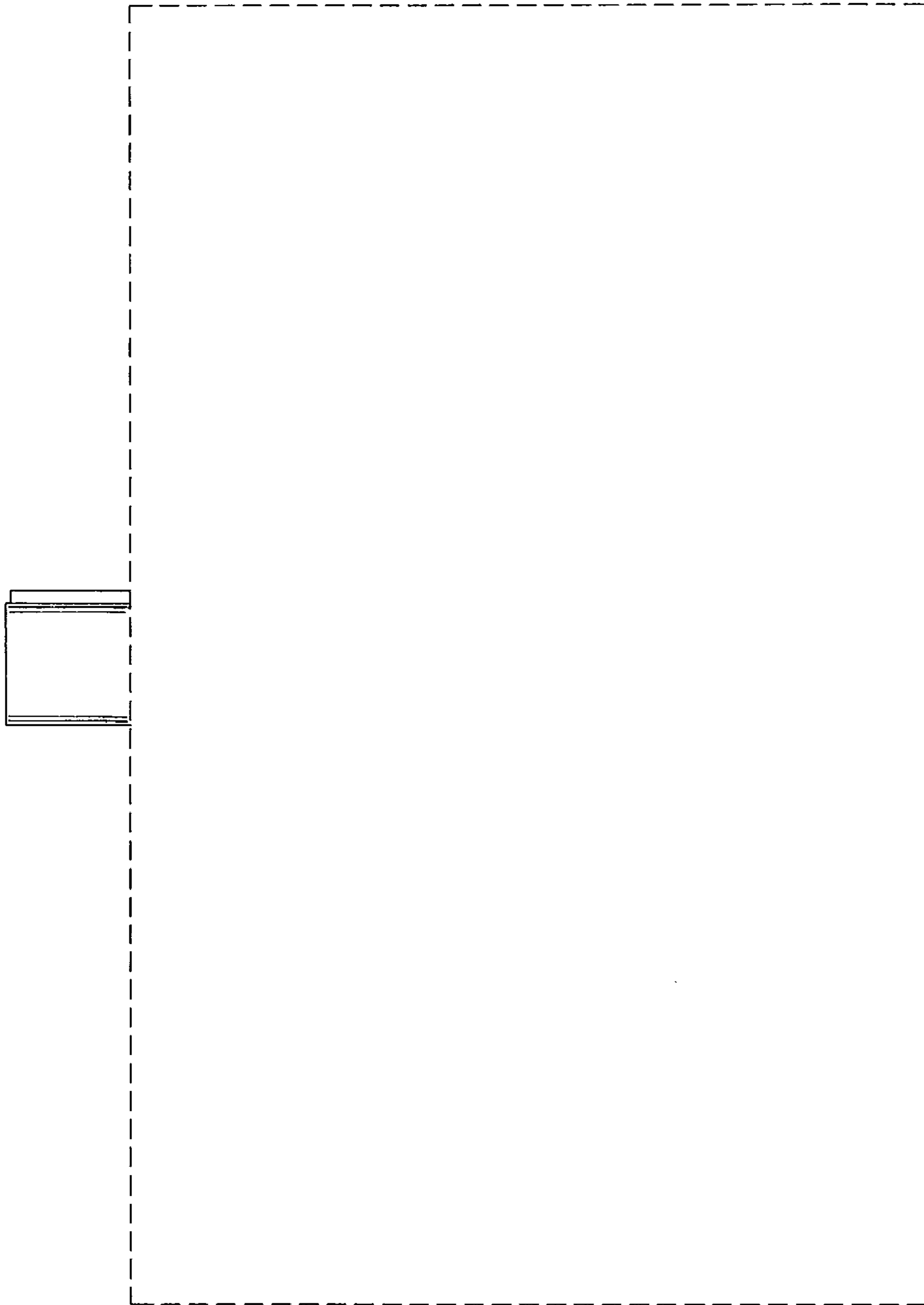

FIG.39

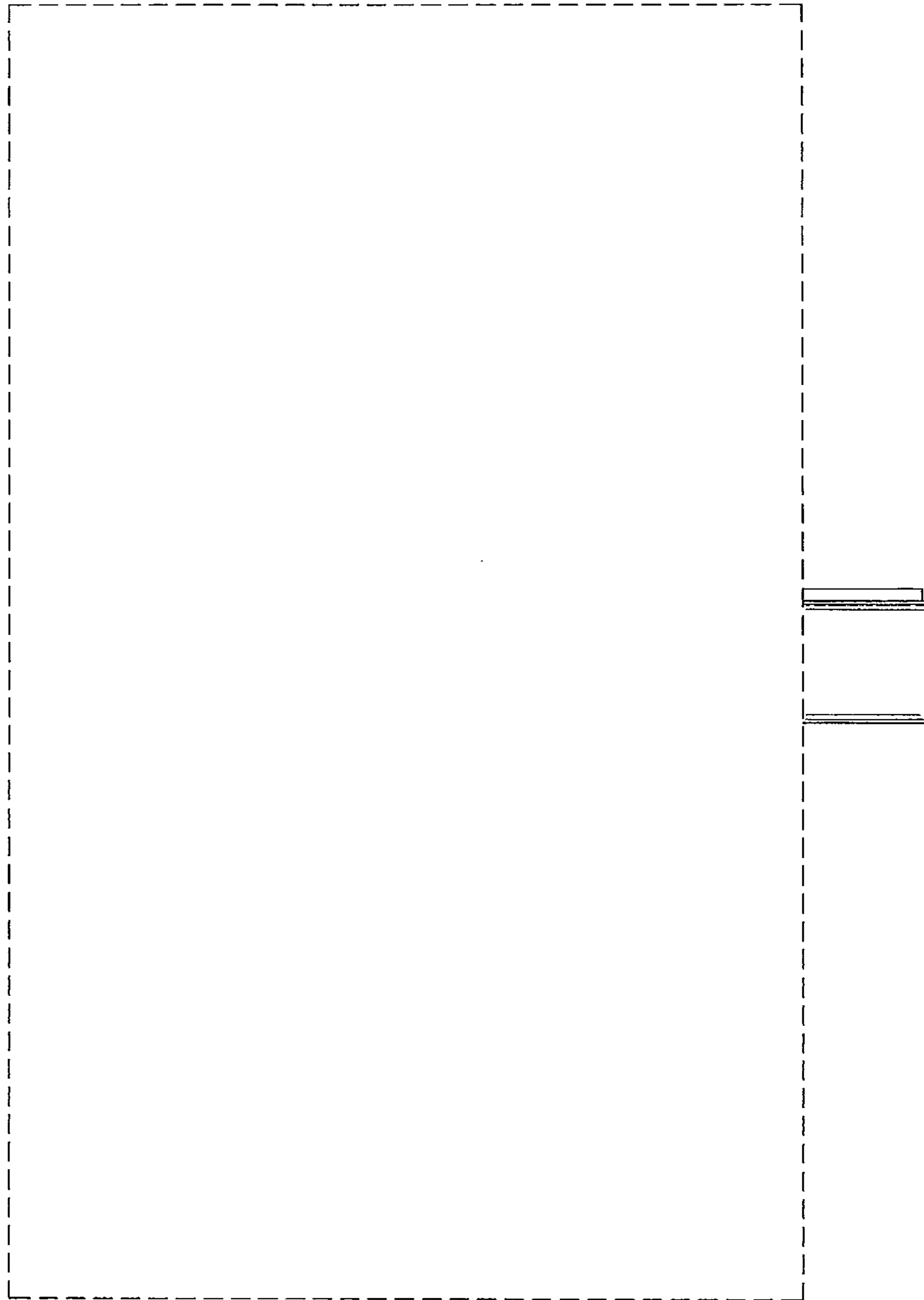

FIG.40