



US00D631909S

(12) **United States Design Patent**
Blanc et al.

(10) **Patent No.:** **US D631,909 S**
(45) **Date of Patent:** **** Feb. 1, 2011**

(54) **LABEL PRINTER**

(75) Inventors: **Jean Francois Blanc**, Paris (FR);
Florian Gounaud, Paris (FR); **Jullien Thaler**, Le Pré Saint Gervais (FR)

(73) Assignee: **Dymo**, Sint-Niklaas (BE)

(**) Term: **14 Years**

(21) Appl. No.: **29/351,801**

(22) Filed: **Dec. 11, 2009**

(30) **Foreign Application Priority Data**

Jun. 12, 2009 (EM) 001146567

(51) **LOC (9) Cl.** **19-08**

(52) **U.S. Cl.** **D18/19; D14/426**

(58) **Field of Classification Search** D18/15-19,
D18/50, 7; 400/462-470, 613.1-613.4; 156/384,
156/DIG. 48, DIG. 49; D19/68; 101/109,
101/328, 329, 375; D14/426, 347, 346
See application file for complete search history.

(56) **References Cited**

U.S. PATENT DOCUMENTS

D312,622 S *	12/1990	Alden et al.	D14/347
D325,574 S *	4/1992	Carver	D14/426
D360,890 S *	8/1995	Tremlett	D18/19
D414,172 S *	9/1999	Hetfield et al.	D14/426
D463,425 S *	9/2002	Jenkins	D14/347
D467,918 S *	12/2002	Fitch et al.	D14/347
D477,598 S *	7/2003	Mathiowetz et al.	D14/347
D491,977 S *	6/2004	Shimoki	D18/19

D496,683 S *	9/2004	Matsumoto et al.	D18/19
D526,004 S *	8/2006	Obenshain et al.	D18/19
D552,606 S *	10/2007	Swanson et al.	D14/346
D557,696 S *	12/2007	Conti et al.	D14/346
D566,753 S *	4/2008	Suzuki et al.	D18/19
D601,620 S *	10/2009	Mase et al.	D18/19
D611,943 S *	3/2010	Boyd	D14/346
D614,626 S *	4/2010	Dai et al.	D14/426

* cited by examiner

Primary Examiner—Charles A Rademaker

(74) *Attorney, Agent, or Firm*—Marshall, Gerstein & Borun LLP

(57) **CLAIM**

The ornamental design for a label printer, as shown and described.

DESCRIPTION

FIG. 1 is a front view showing our new design for a label printer;

FIG. 2 is a left side view of the label printer of FIG. 1;

FIG. 3 is a front and right side perspective view of the label printer of FIG. 1;

FIG. 4 is a front and left side perspective view of the label printer of FIG. 1;

FIG. 5 is a front and top left perspective view of the label printer of FIG. 1;

FIG. 6 is a front and top right perspective view of the label printer of FIG. 1; and,

FIG. 7 is a back view of the label printer of FIG. 1.

1 Claim, 7 Drawing Sheets

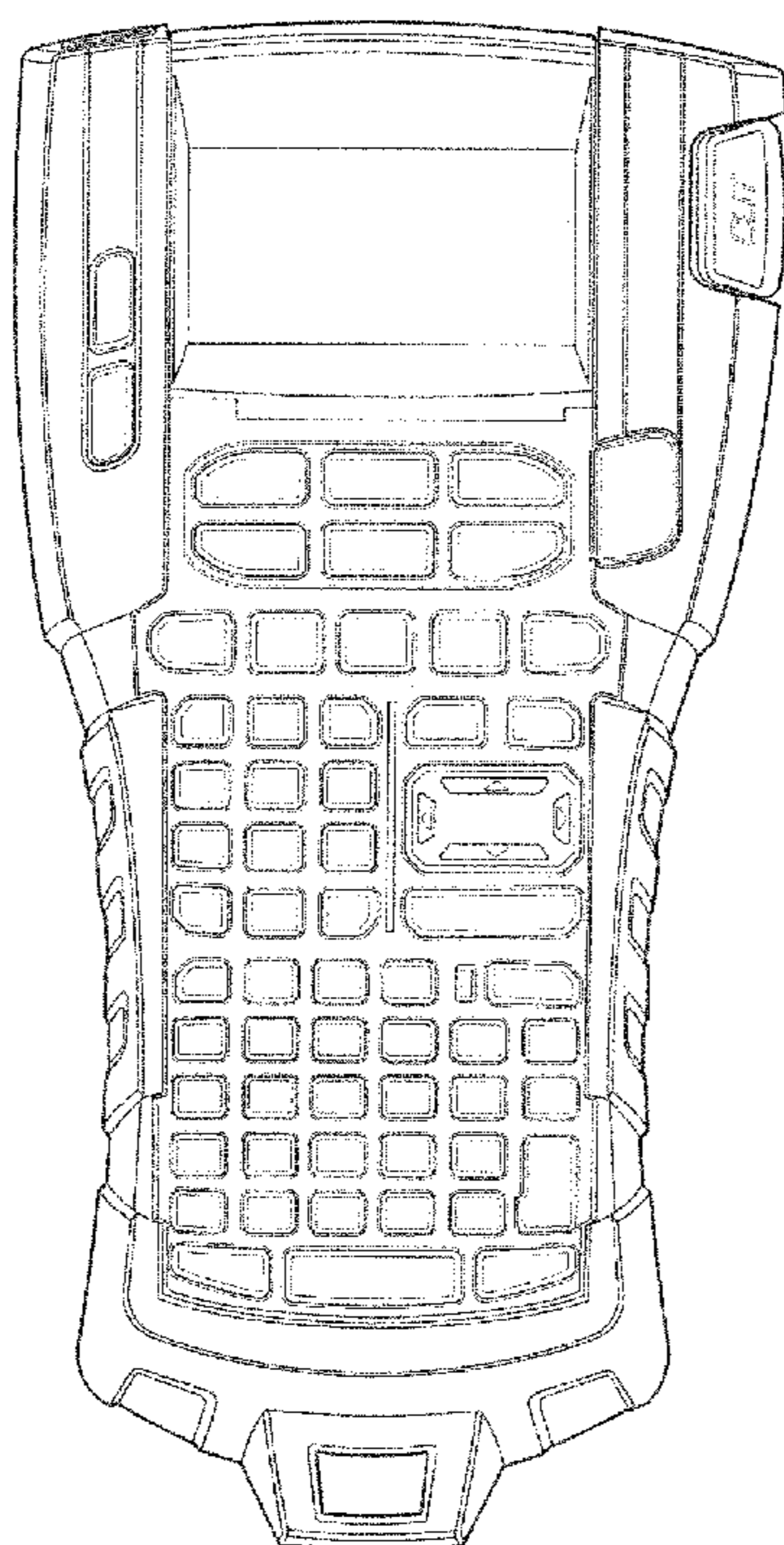

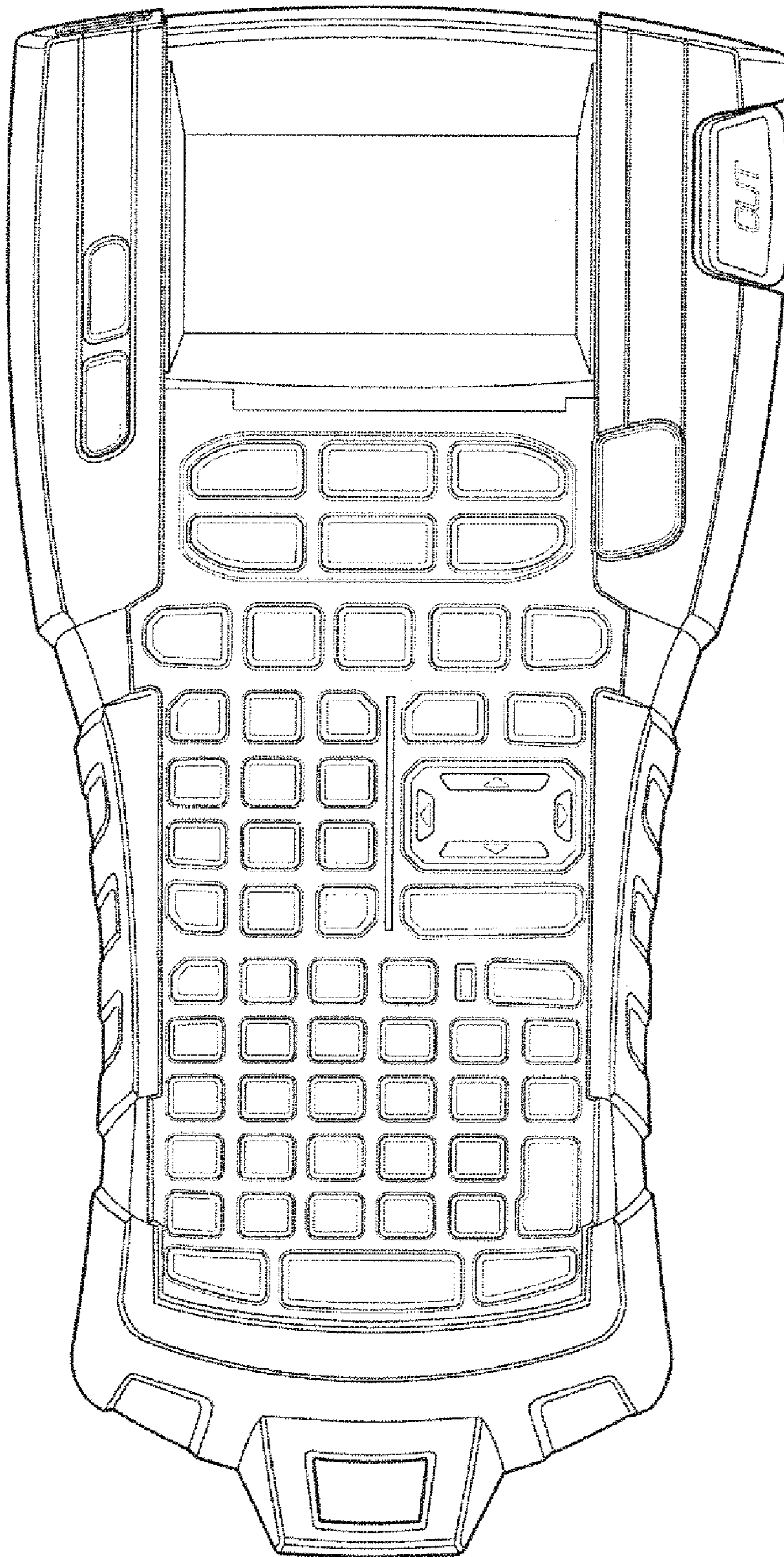

FIG. 1

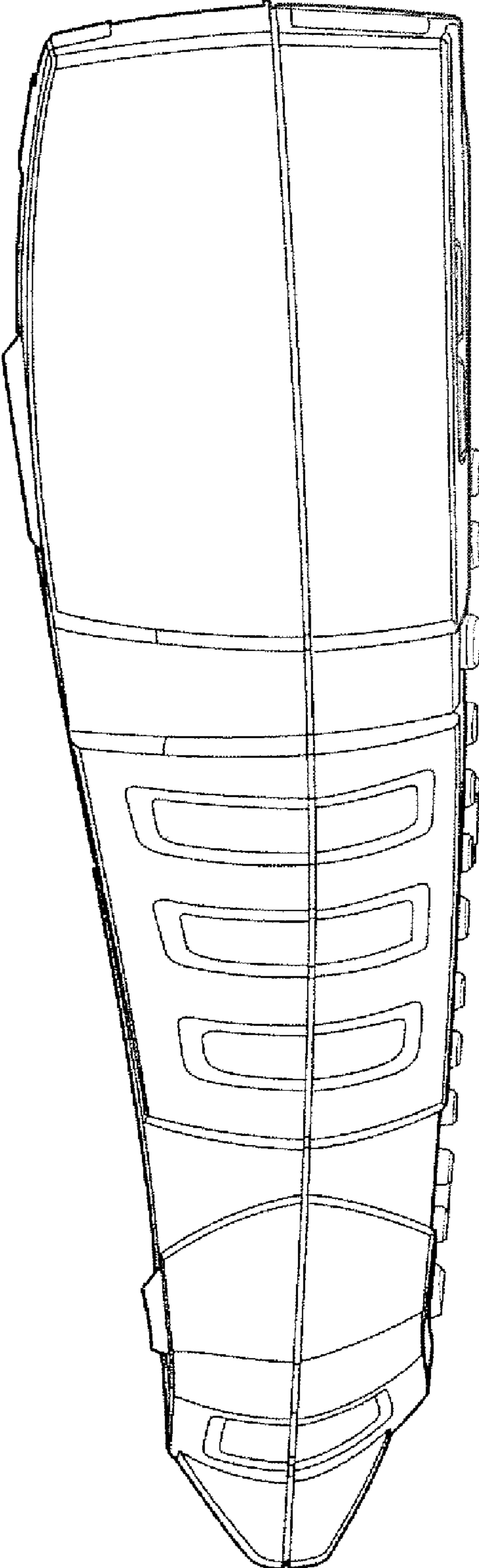

FIG. 2

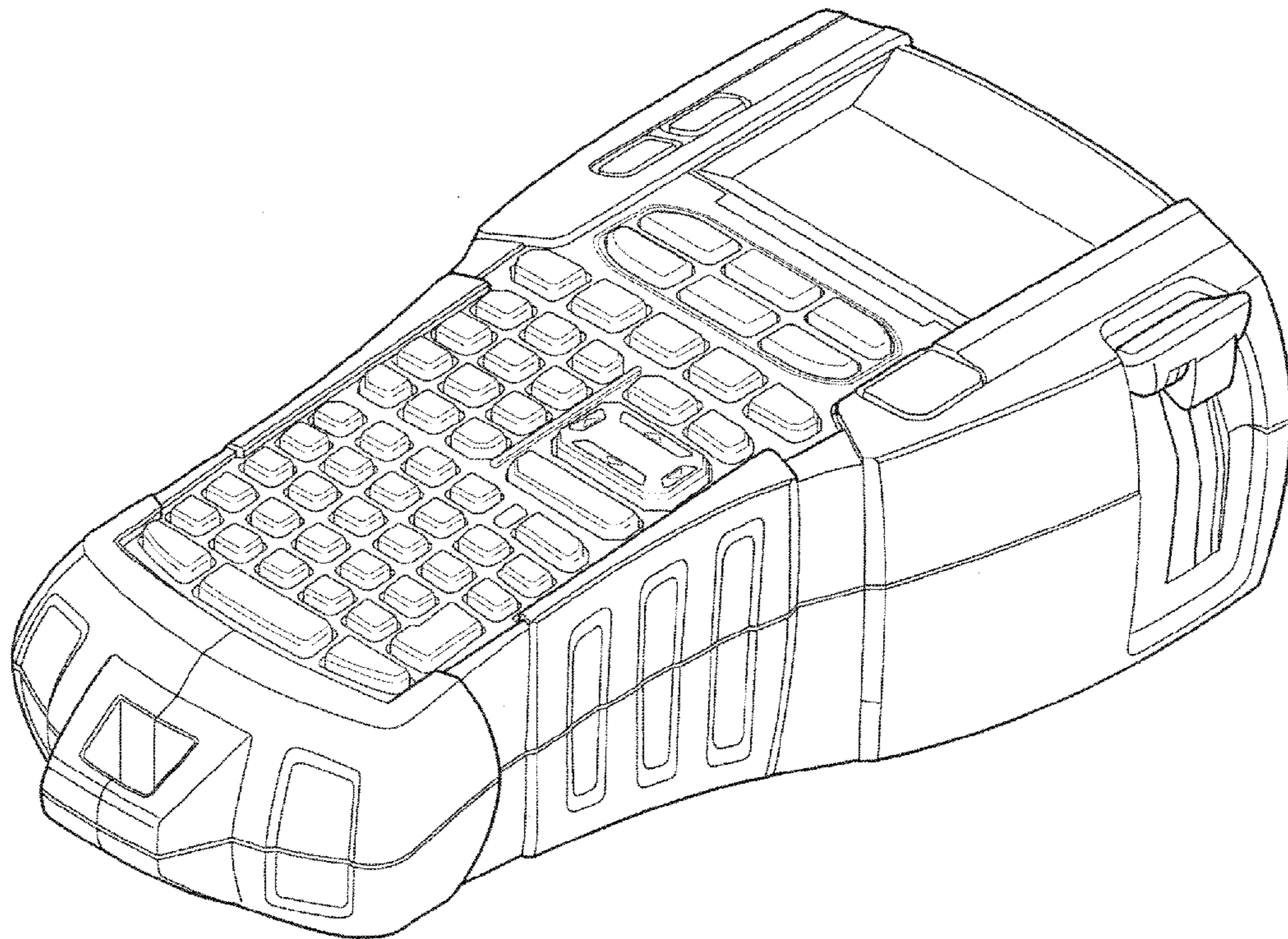

FIG. 3

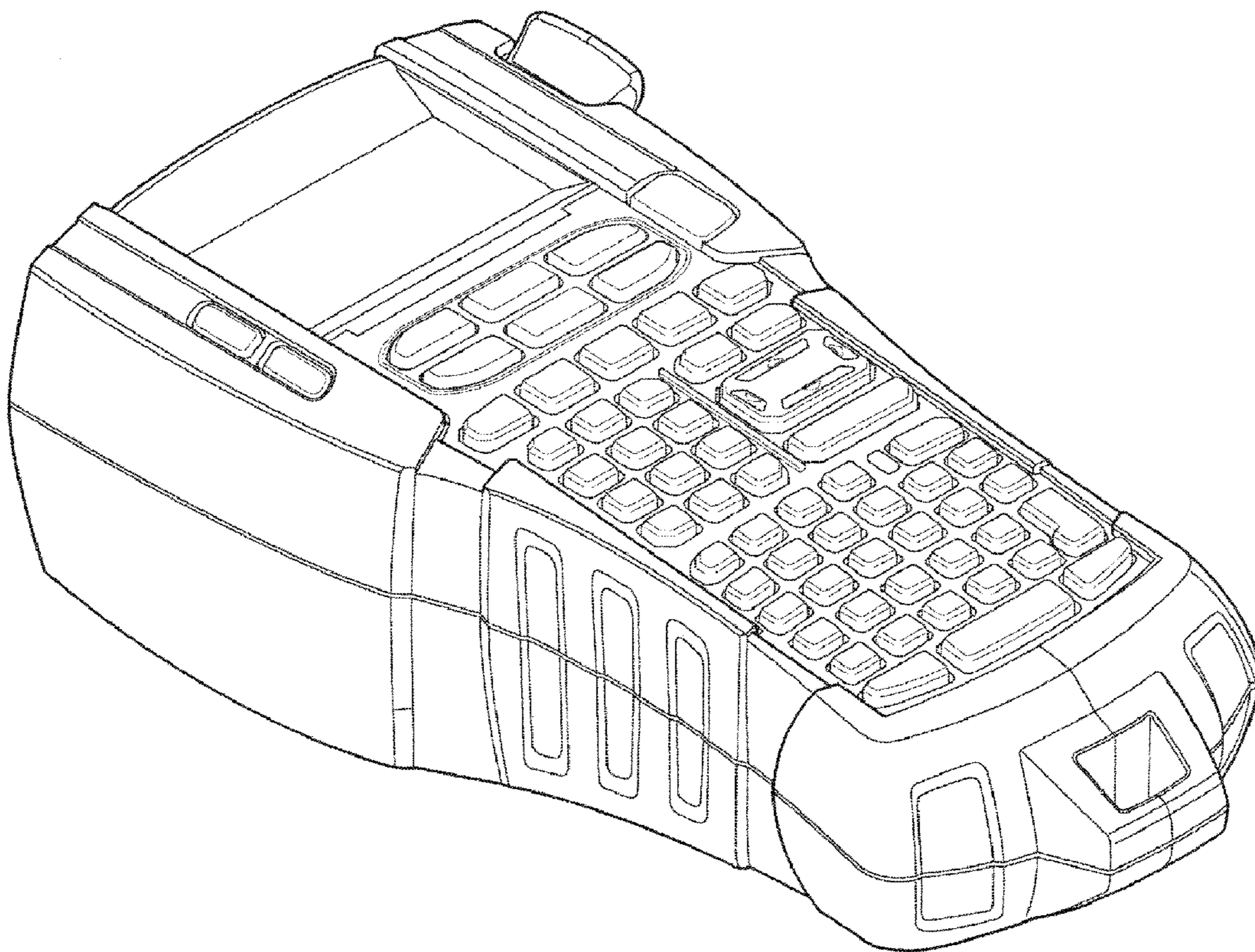

FIG. 4

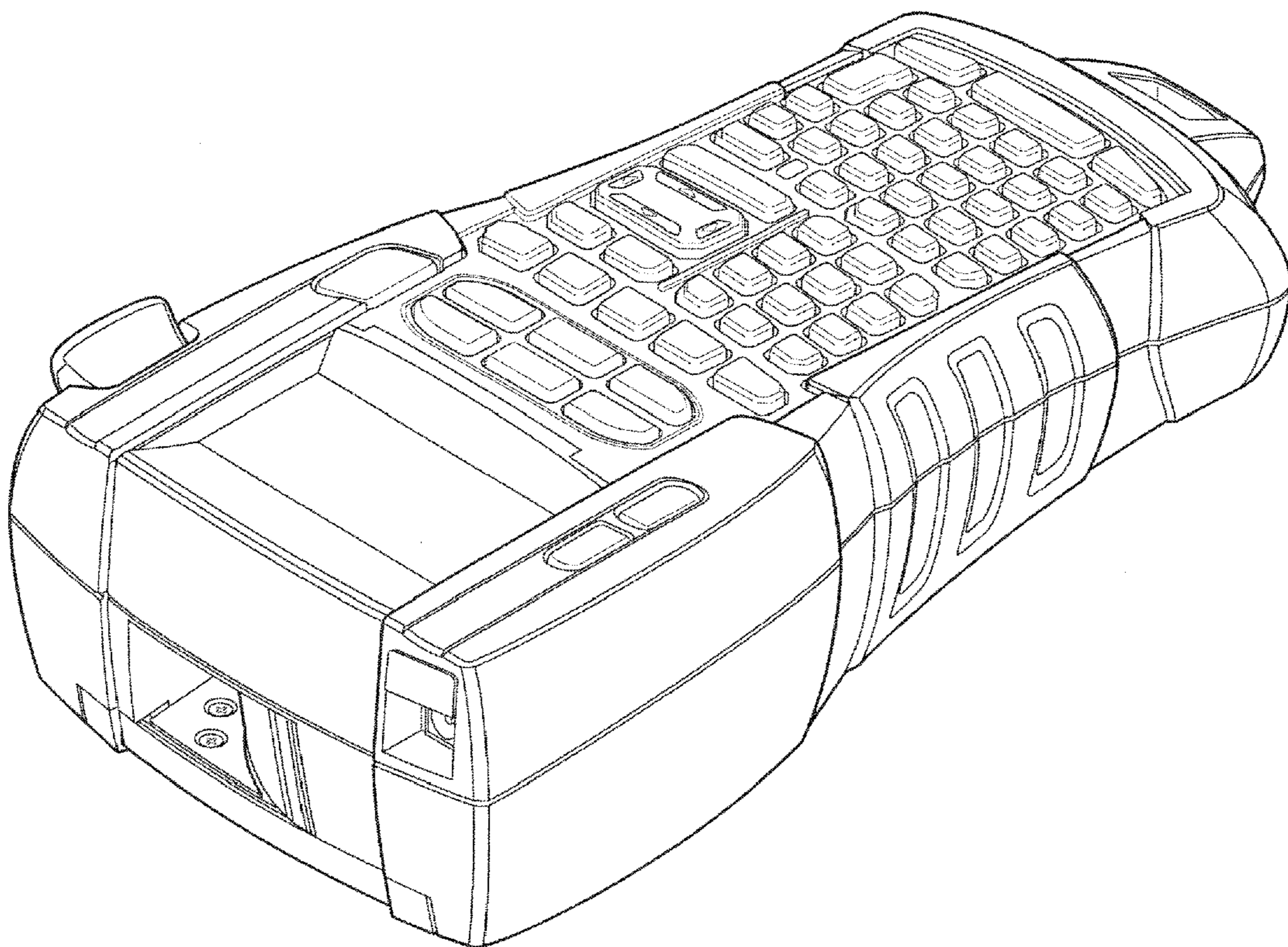

FIG. 5

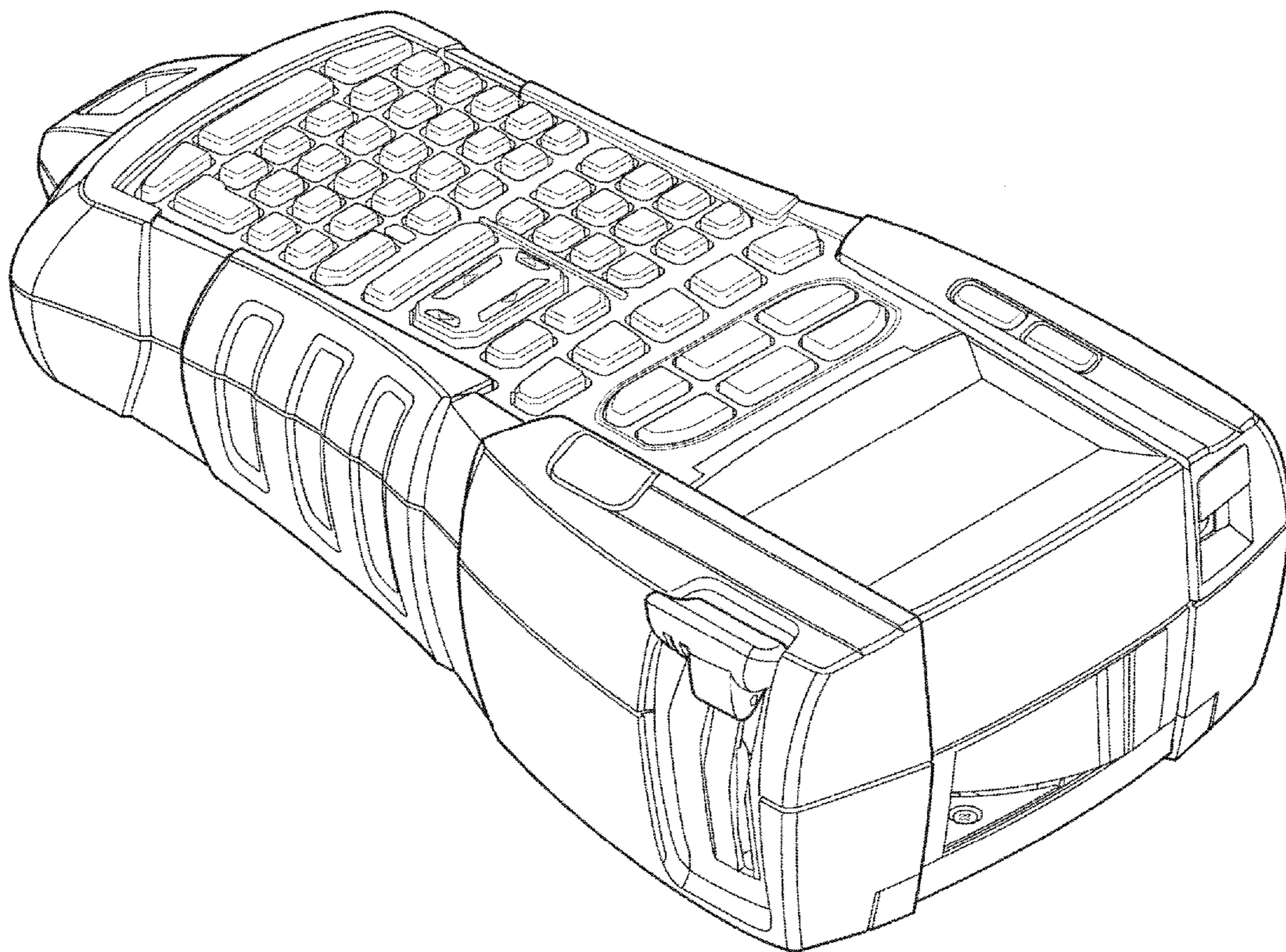

FIG. 6

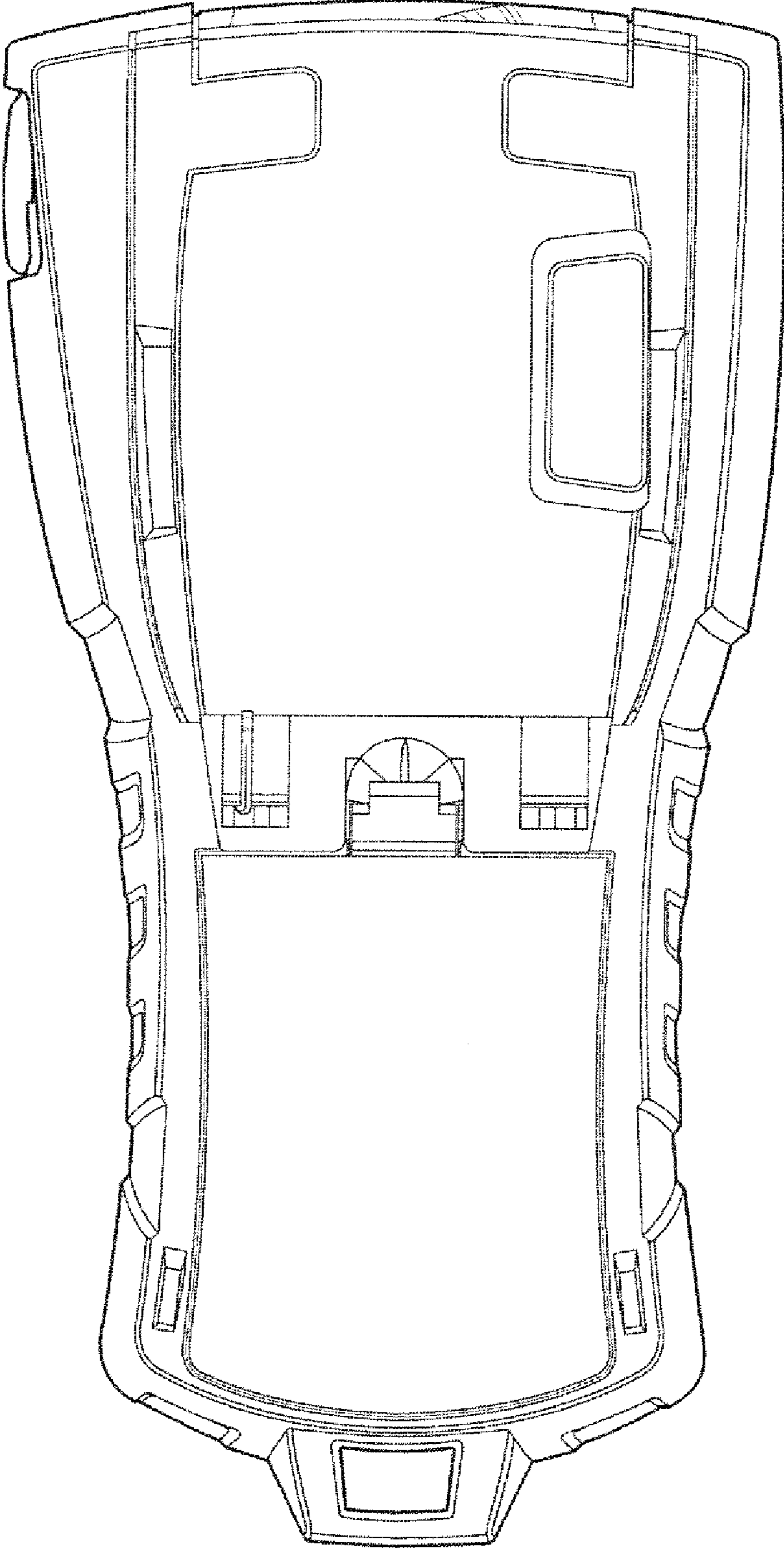

FIG. 7