



US00D631862S

(12) **United States Design Patent**  
**Chu**

(10) **Patent No.:** **US D631,862 S**  
(45) **Date of Patent:** **\*\* Feb. 1, 2011**

(54) **DISPLAY**

(75) Inventor: **Chih-Ming Chu**, Taipei (TW)

(73) Assignee: **Hannspree, Inc.**, Taipei County (TW)

(\*\*) Term: **14 Years**

(21) Appl. No.: **29/375,921**

(22) Filed: **Sep. 29, 2010**

(51) **LOC (9) Cl.** ..... **14-03**

(52) **U.S. Cl.** ..... **D14/126**

(58) **Field of Classification Search** ..... D14/125-134,  
D14/239, 371, 136, 374-377, 440, 450, 448,  
D14/336, 342; 312/7.2; 348/836, 838, 180,  
348/184, 325, 739; 341/12; 248/917-924,  
248/465; 345/104, 133, 156, 168, 87, 173;  
720/605, 669, 600, 655; 369/99, 197; 455/344,  
455/347; D21/329, 515, 577, 622, 333, 433,  
D21/448, 452, 450, 331; D6/477, 479, 300;  
273/148 B; 446/484, 175, 356; D10/15,  
D10/26

See application file for complete search history.

(56) **References Cited**

**U.S. PATENT DOCUMENTS**

D473,865 S \* 4/2003 Zuege et al. .... D14/371

D473,866 S \* 4/2003 Zuege et al. .... D14/371  
D476,003 S \* 6/2003 Zuege et al. .... D14/371  
D531,594 S \* 11/2006 Hoehn et al. .... D14/126  
D546,298 S \* 7/2007 Hoehn ..... D14/126  
D608,360 S \* 1/2010 Chu ..... D14/371  
D608,782 S \* 1/2010 Chu ..... D14/371

\* cited by examiner

*Primary Examiner*—Raphael Barkai

(74) *Attorney, Agent, or Firm*—Tim Tingkang Xia; Morris,  
Manning & Martin, LLP

(57) **CLAIM**

The ornamental design for a “display,” as shown and described.

**DESCRIPTION**

FIG. 1. is a front perspective view of a “display” of the present invention;

FIG. 2. is a front view thereof;

FIG. 3. is a rear view thereof;

FIG. 4. is a left side view thereof;

FIG. 5. is a right side view thereof;

FIG. 6. is a top view thereof; and,

FIG. 7. is a bottom view thereof.

**1 Claim, 7 Drawing Sheets**

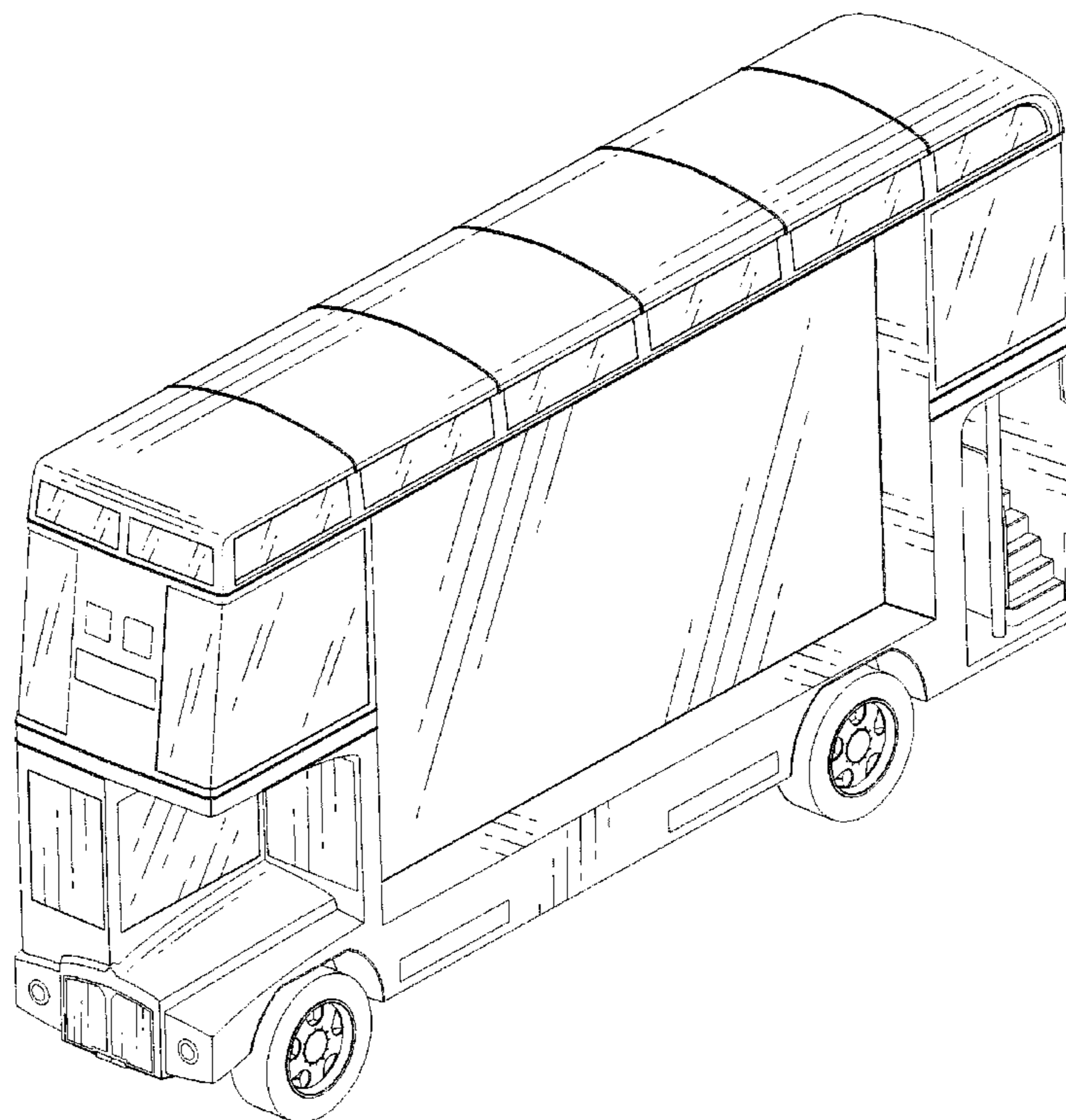

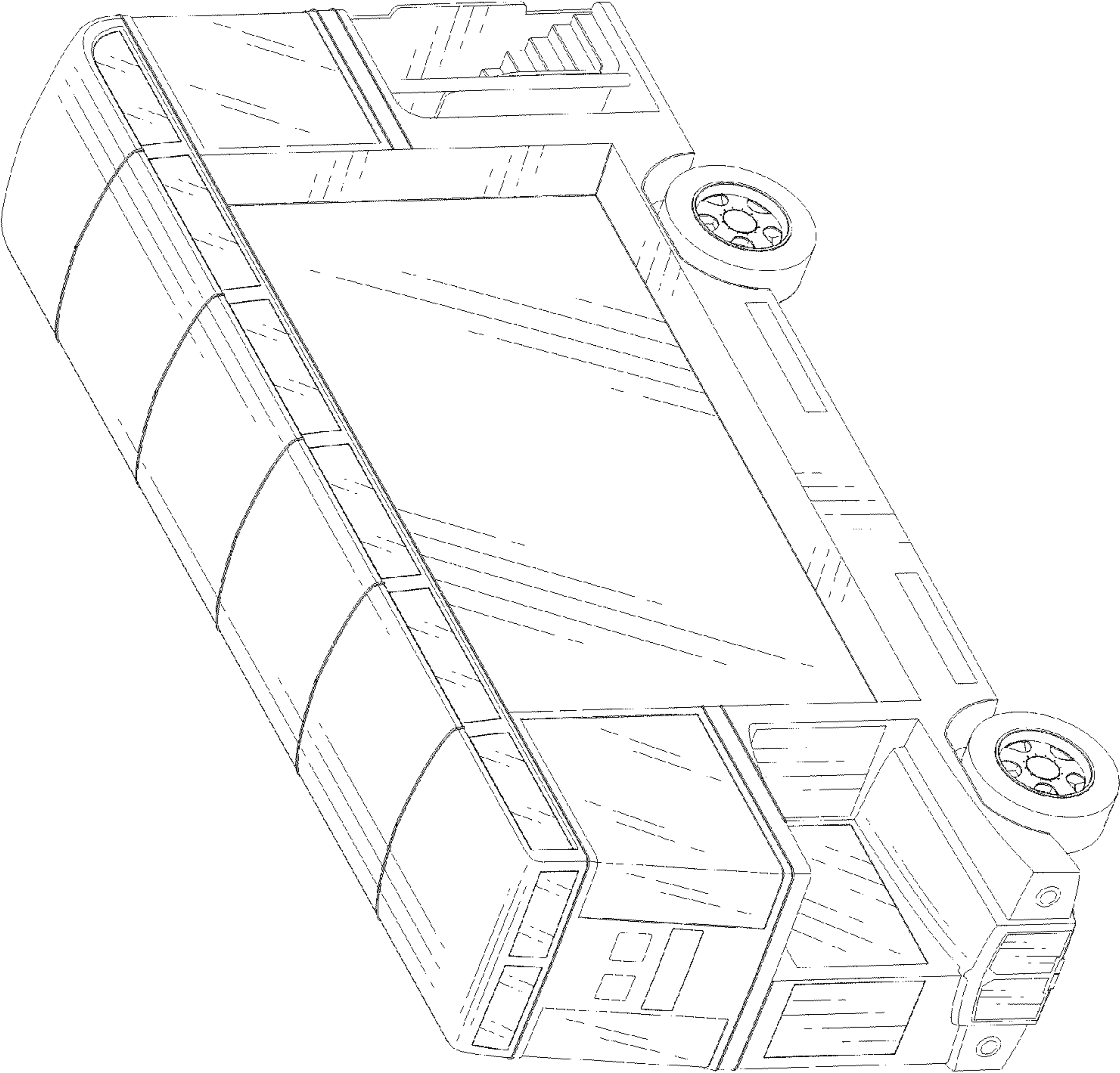

FIG. 1

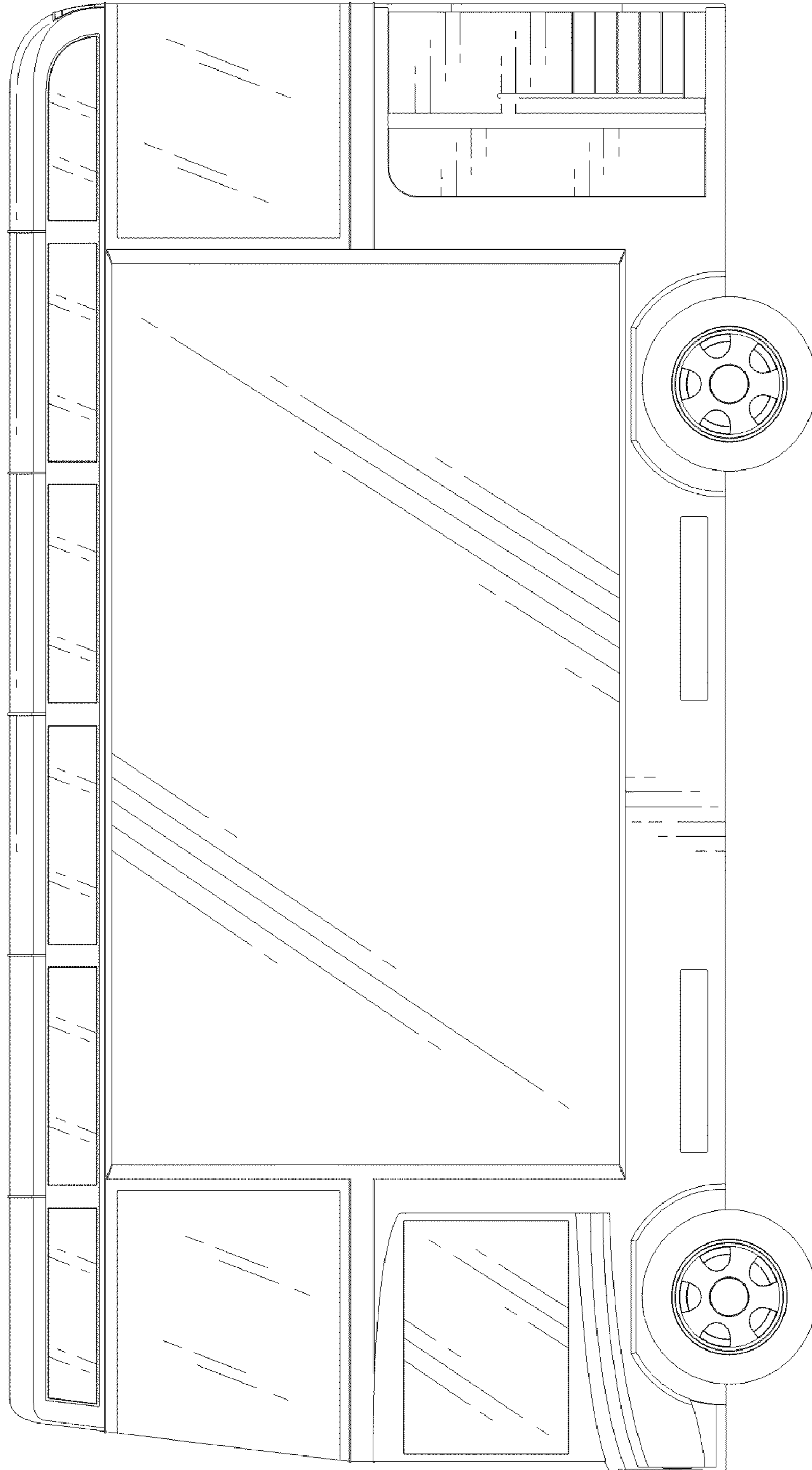

FIG. 2

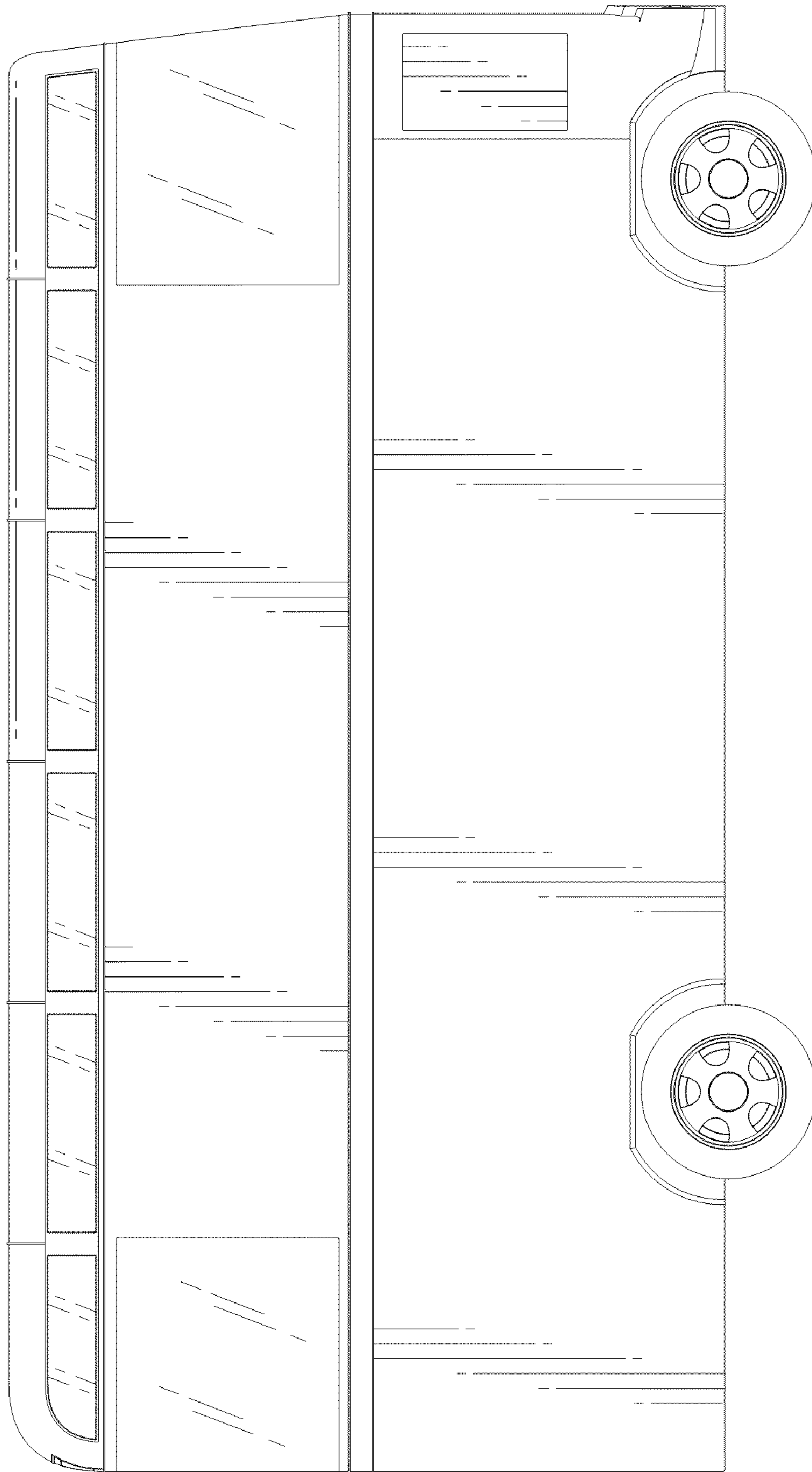

FIG. 3

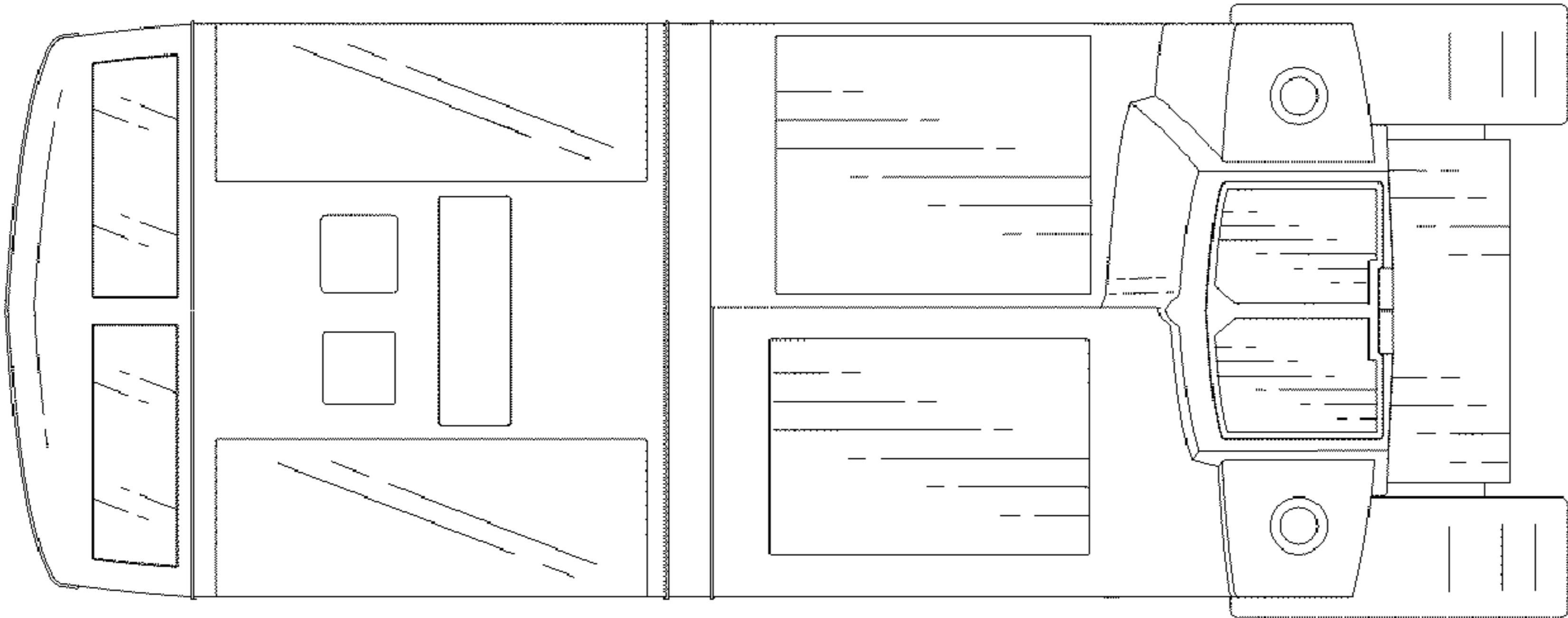

FIG. 4

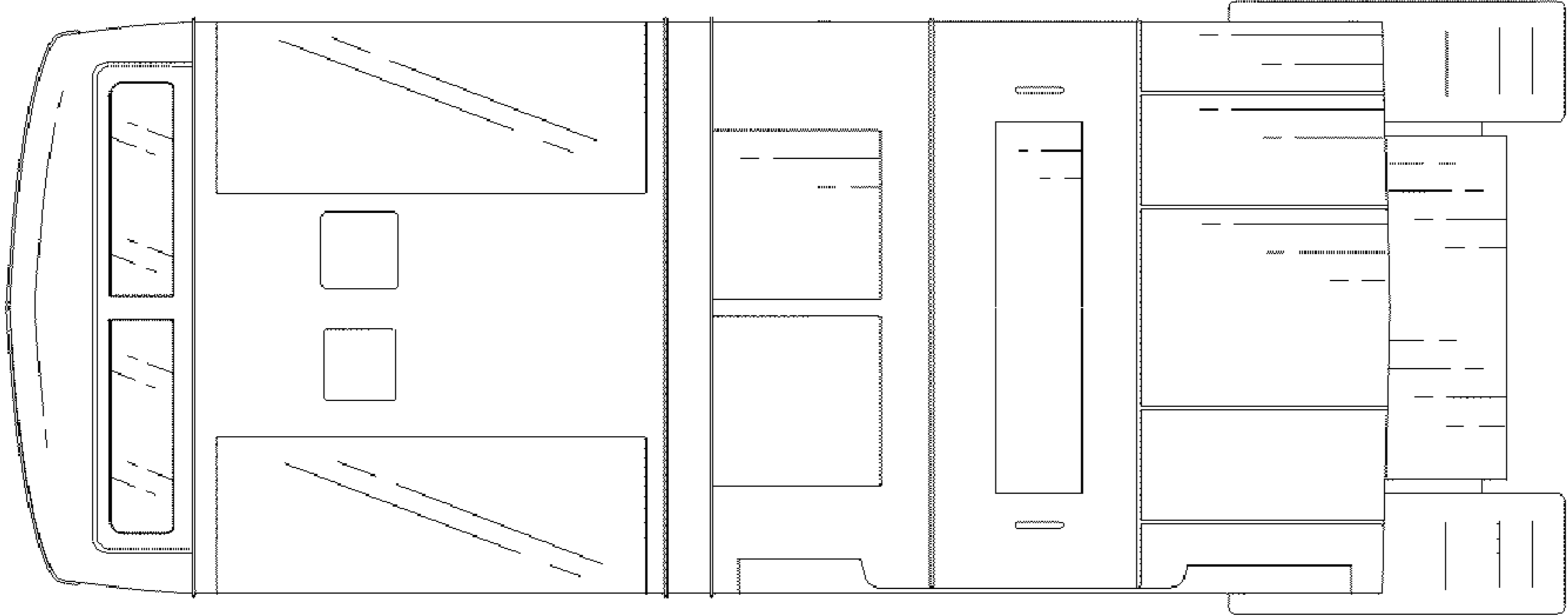

FIG. 5

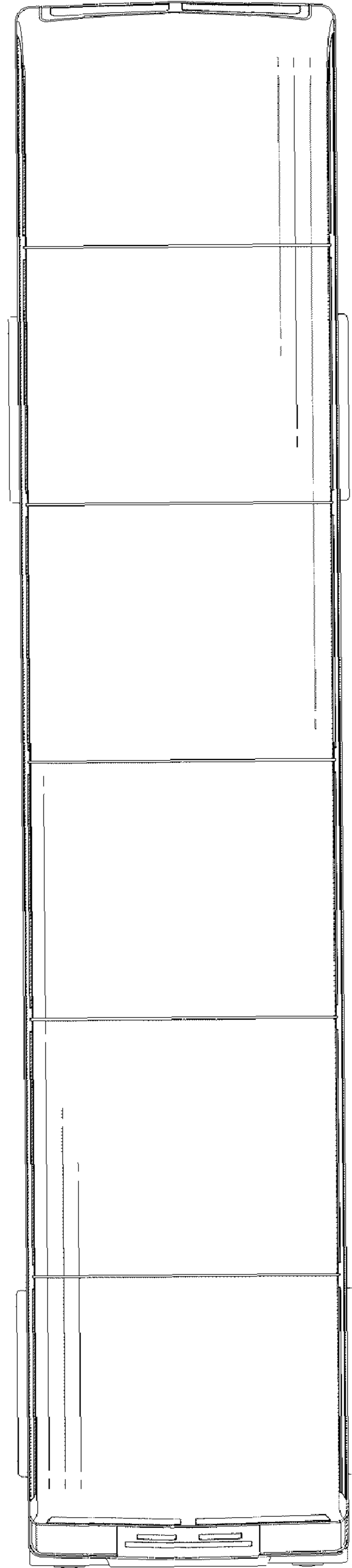

FIG. 6

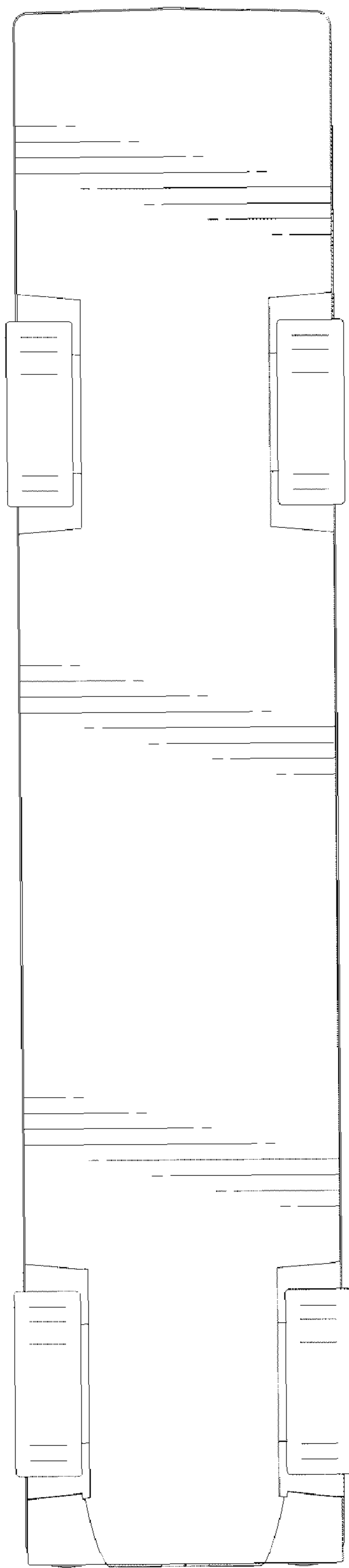

FIG. 7