

US00D631846S

(12) **United States Design Patent**
Truskett et al.

(10) **Patent No.:** **US D631,846 S**

(45) **Date of Patent:** **** *Feb. 1, 2011**

(54) **CONTACTS FOR A TERMINATION MODULE CRADLE**

(75) Inventors: **Kevin James Truskett**, Kincumber (AU); **Simon Ellis**, Killarney Vale (AU); **Wayne William Dennes**, Wyoming (AU); **Bryce Lindsay Nicholls**, Green Point (AU); **Brett Hoe Slater**, Hornsby (AU); **Malcolm Bruce Brear**, Empire Bay (AU)

(73) Assignee: **ADC GmbH**, Berlin (DE)

(**) Term: **14 Years**

(21) Appl. No.: **29/336,905**

(22) Filed: **May 12, 2009**

(30) **Foreign Application Priority Data**

Nov. 12, 2008 (AU) 15328/2008

(51) **LOC (9) Cl.** **13-03**

(52) **U.S. Cl.** **D13/154; D13/147; D13/120**

(58) **Field of Classification Search** D13/103–106, D13/118–121, 133, 146, 147, 154, 184, 199; 439/732, 844, 849, 850–852, 865–867, 870, 439/872, 877, 884–891

See application file for complete search history.

(56) **References Cited**

U.S. PATENT DOCUMENTS

3,931,946 A 1/1976 Soltysik
D401,217 S * 11/1998 Wirth D13/120
D491,535 S * 6/2004 Chien D13/154

D554,589 S * 11/2007 Kondas D13/149
D568,815 S * 5/2008 Chiang et al. D13/133
D582,348 S * 12/2008 Shiu D13/154
D586,300 S * 2/2009 Wang D13/154
D605,137 S * 12/2009 Yu et al. D13/154
2007/0275299 A1 * 11/2007 Larsen 429/100

FOREIGN PATENT DOCUMENTS

TW 123833 7/2008

OTHER PUBLICATIONS

English translation of a Taiwanese Office Action mailed Dec. 31, 2009 in connection with Taiwanese Application No. 098302198, which relates to the pending application.

* cited by examiner

Primary Examiner—Rosemary K Tarca

(74) *Attorney, Agent, or Firm*—Merchant & Gould P.C.

(57) **CLAIM**

The ornamental design for contacts for a termination module cradle, as shown and described.

DESCRIPTION

FIG. 1 is a top view showing the contacts for a termination module cradle;

FIG. 2 is a bottom view thereof;

FIG. 3 is a side view;

FIG. 4 is another side view;

FIG. 5 is a perspective view;

FIG. 6 is a back view; and,

FIG. 7 is a front view thereof.

1 Claim, 2 Drawing Sheets

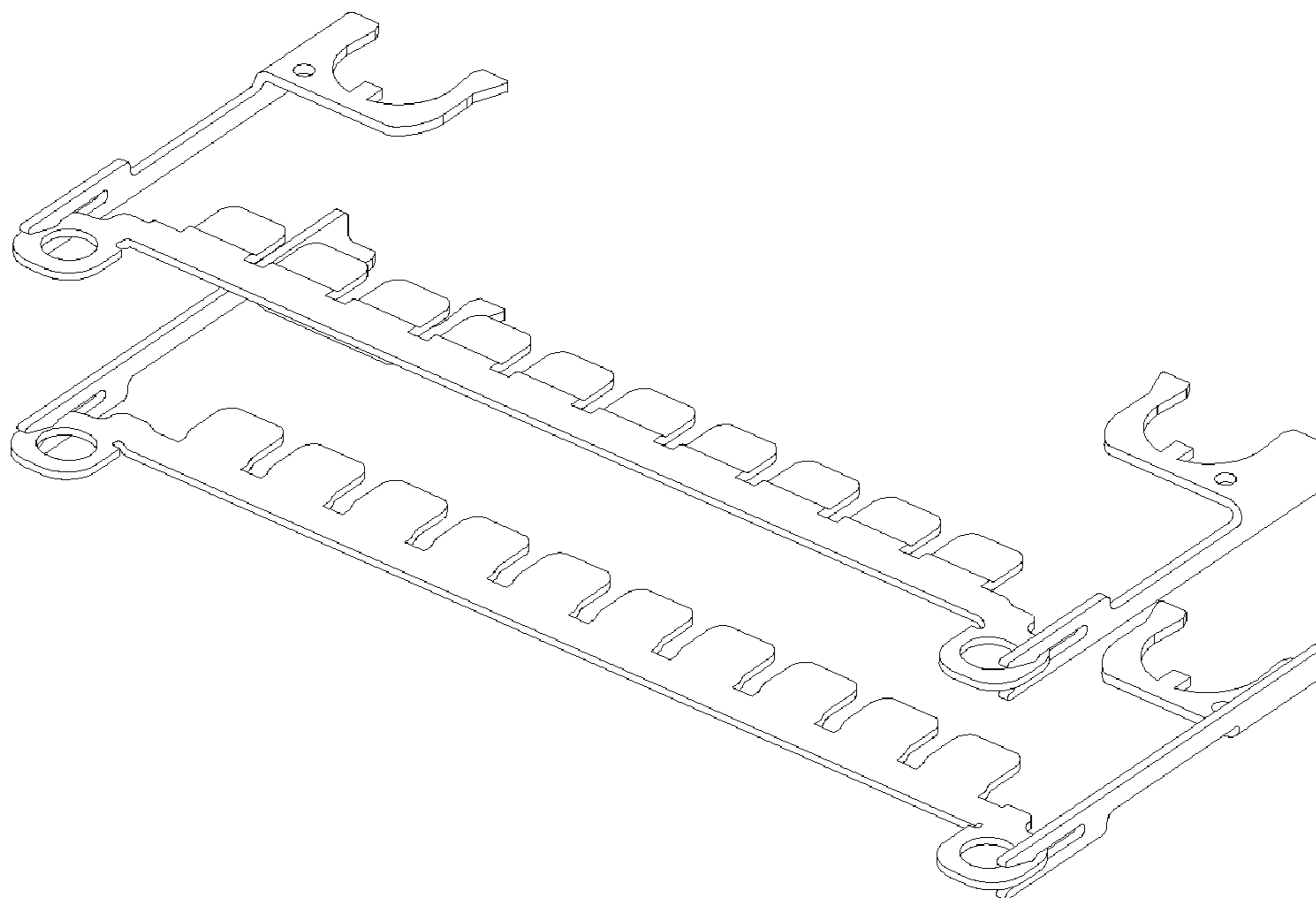

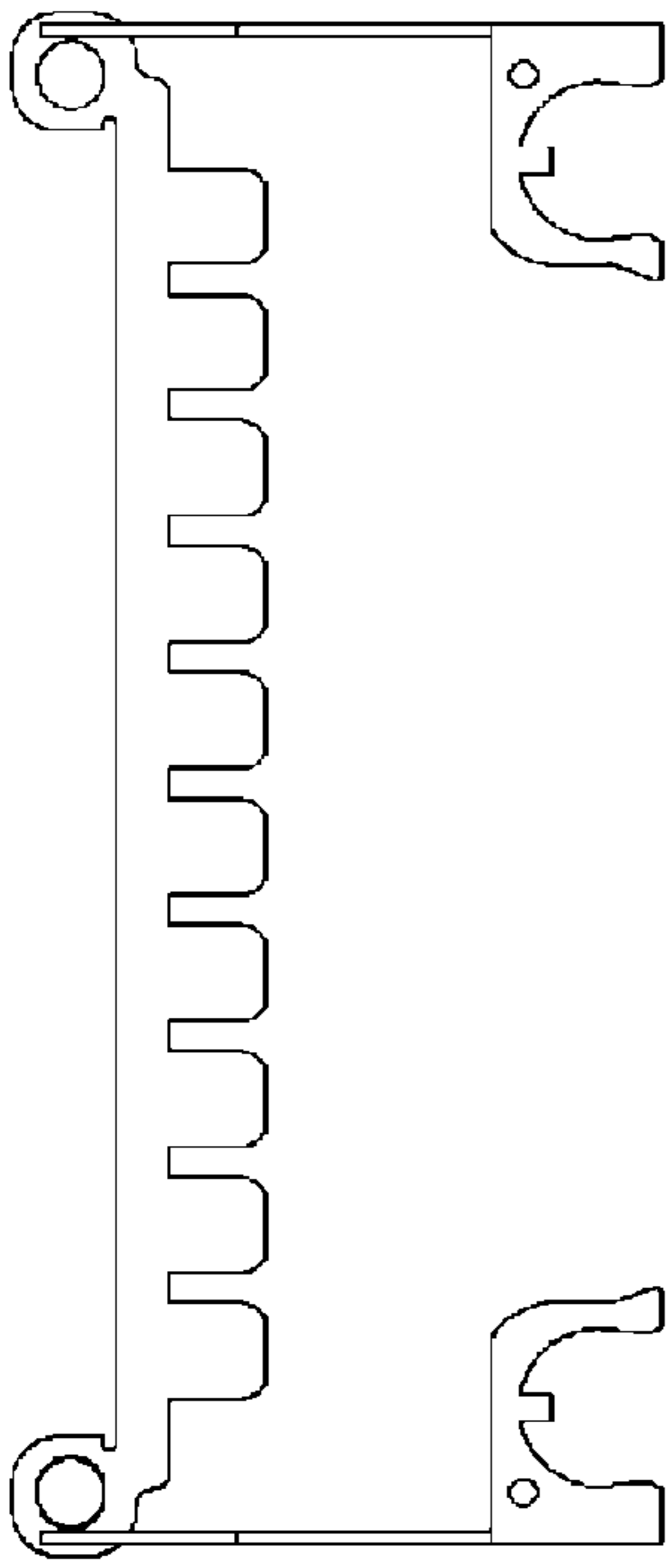

Figure 1

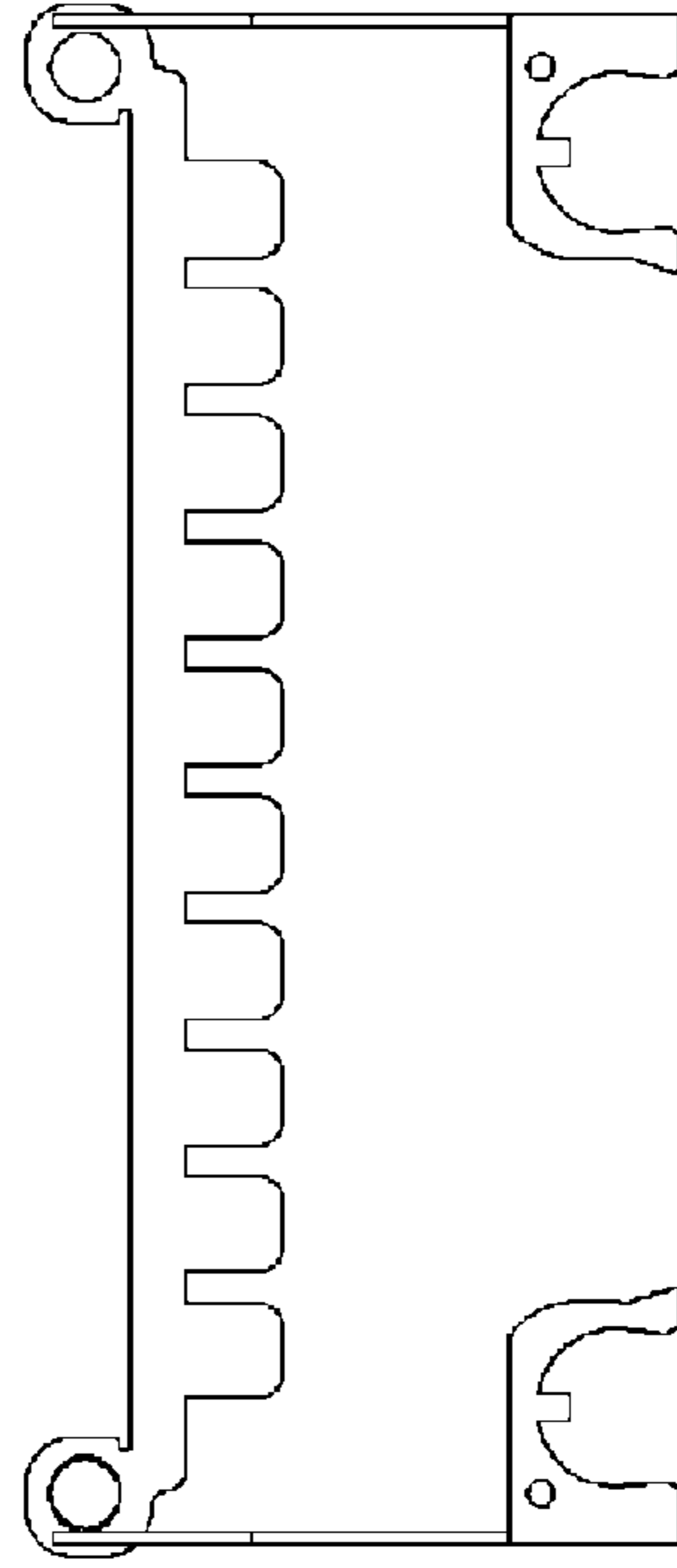

Figure 2

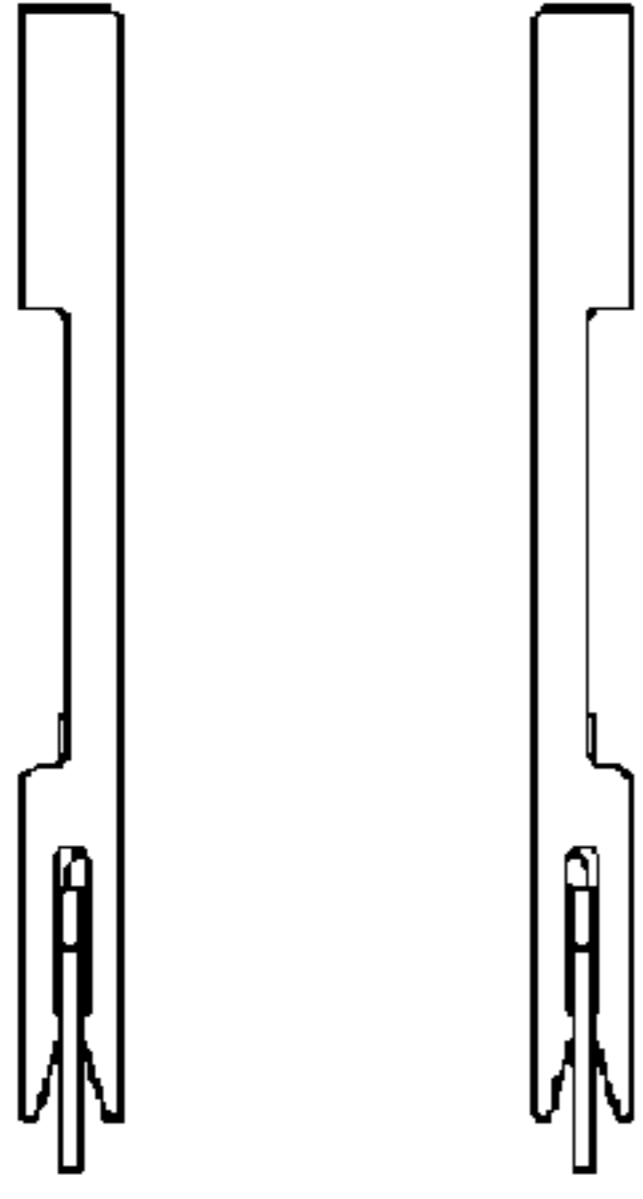

Figure 3

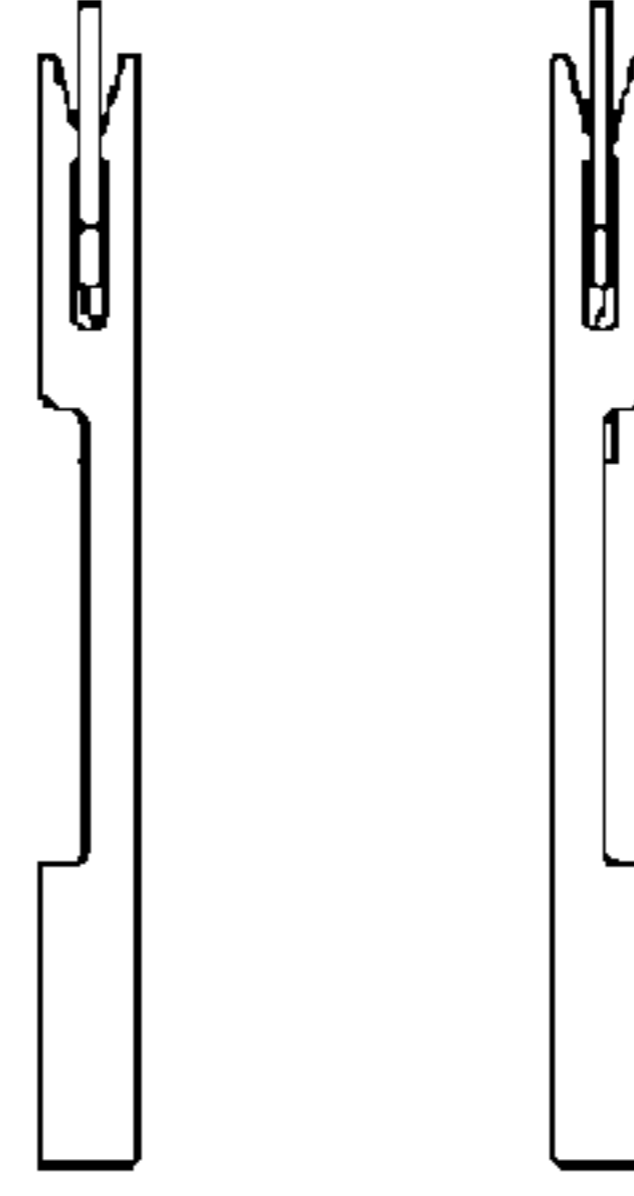

Figure 4

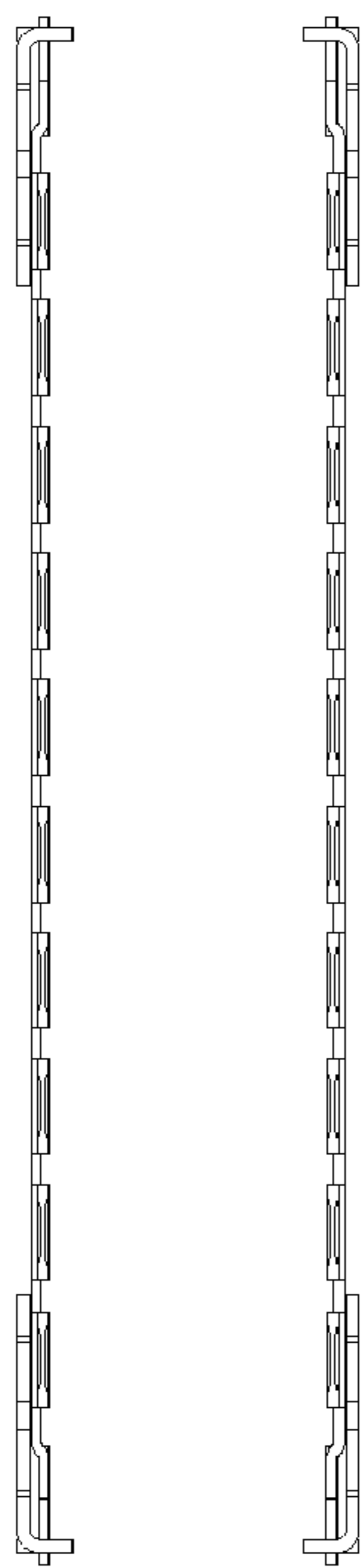

Figure 6

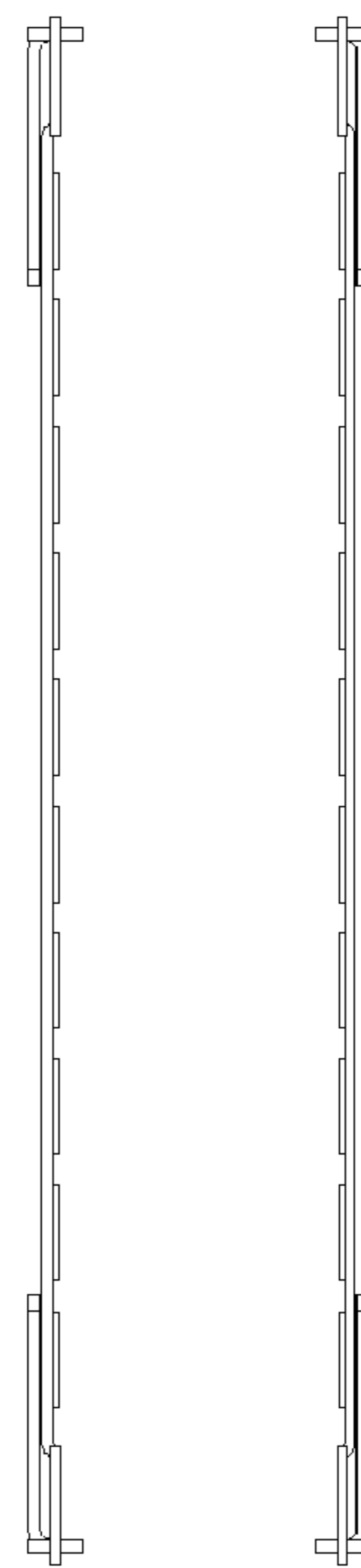

Figure 7

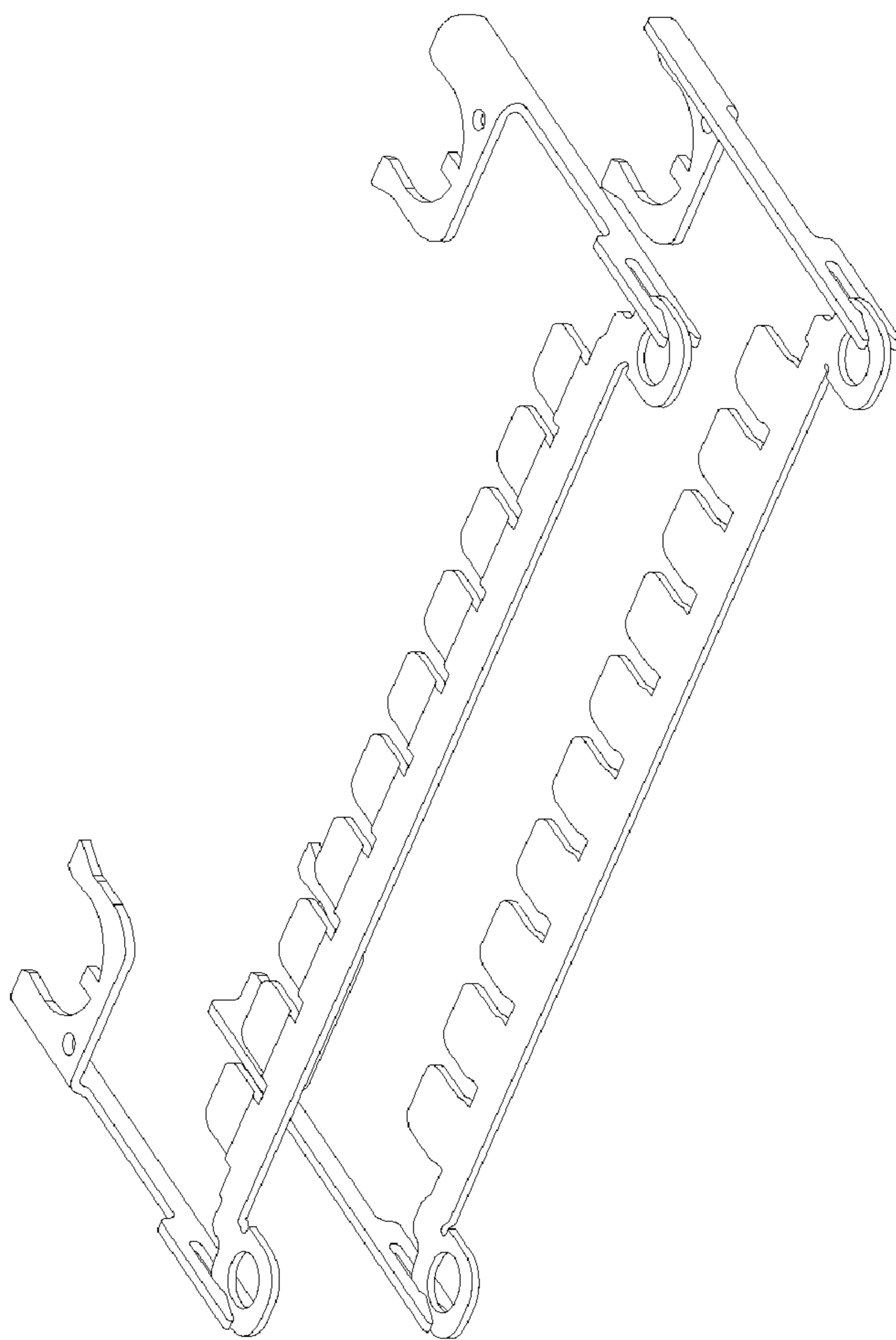

Figure 5