



US00D631835S

(12) **United States Design Patent**
Neidhart

(10) **Patent No.:** **US D631,835 S**

(45) **Date of Patent:** **** Feb. 1, 2011**

(54) **BATTERY CASE**

(75) Inventor: **Philippe Neidhart**, Laconnex (CH)

(73) Assignee: **Team Orion Europe S.A.** (CH)

(**) Term: **14 Years**

(21) Appl. No.: **29/351,492**

(22) Filed: **Dec. 7, 2009**

(30) **Foreign Application Priority Data**

Jul. 3, 2009 (WO) DM/072 061

(51) **LOC (9) Cl.** **13-02**

(52) **U.S. Cl.** **D13/103**

(58) **Field of Classification Search** D13/102–106,
D13/110, 118–119, 184, 199; 429/96–100,
429/163, 176

See application file for complete search history.

(56) **References Cited**

U.S. PATENT DOCUMENTS

D344,061 S *	2/1994	Tse	D13/103
D398,578 S *	9/1998	Chambers et al.	D13/103
D399,484 S *	10/1998	Higgins et al.	D13/103
D404,356 S *	1/1999	Higgins et al.	D13/103
D480,355 S *	10/2003	Pepin et al.	D13/103
D481,995 S *	11/2003	Yokota	D13/103

D538,222 S *	3/2007	Curello et al.	D13/103
D538,226 S *	3/2007	Lyman et al.	D13/119
D585,366 S *	1/2009	Burchette	D13/103
D597,483 S *	8/2009	Wahl et al.	D13/103
D601,494 S *	10/2009	Otani et al.	D13/103
D614,124 S *	4/2010	Mistyurik	D13/103
2009/0202893 A1 *	8/2009	Ishihara et al.	429/98

* cited by examiner

Primary Examiner—Rosemary K Tarcza

(74) *Attorney, Agent, or Firm*—Reinhart Boerner Van Deuren P.C.

(57) **CLAIM**

I claim the ornamental design for battery case, as shown and described.

DESCRIPTION

FIG. 1 is a perspective view of the battery.

FIG. 2 is a top view of the battery of FIG. 1.

FIG. 3 is a bottom view of the battery of FIG. 1.

FIG. 4 is a back side view of the battery of FIG. 1.

FIG. 5 is a front side view of the battery of FIG. 1.

FIG. 6 is a left end view of the battery shown in FIG. 1; and,

FIG. 7 is a right end view of the battery shown in FIG. 1.

1 Claim, 7 Drawing Sheets

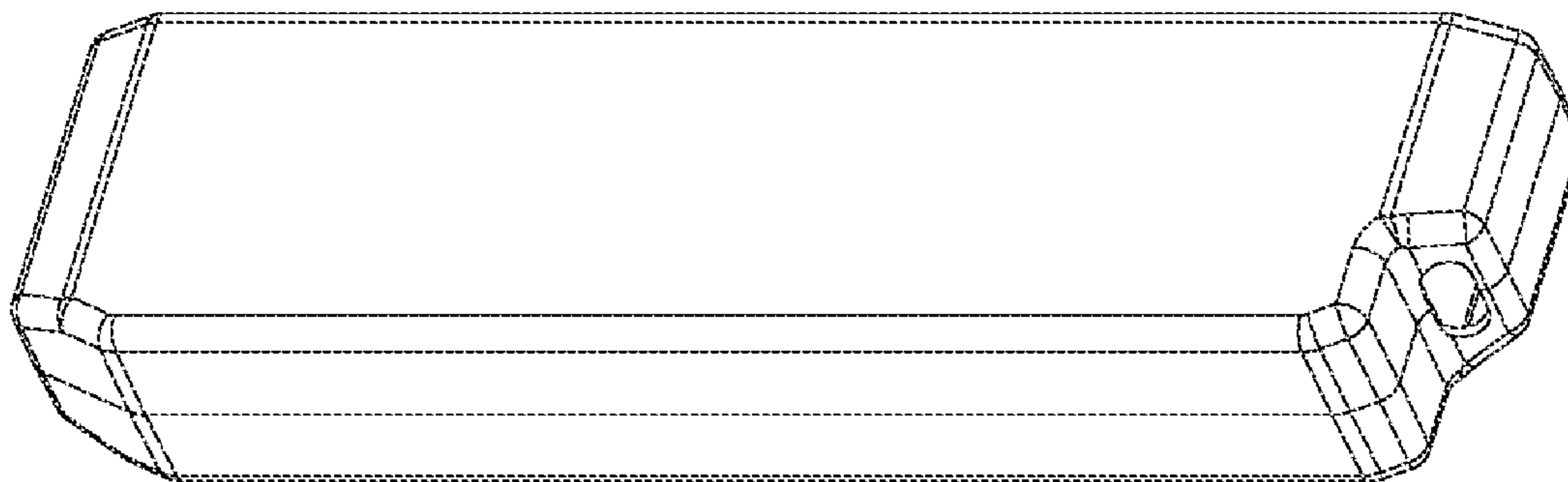

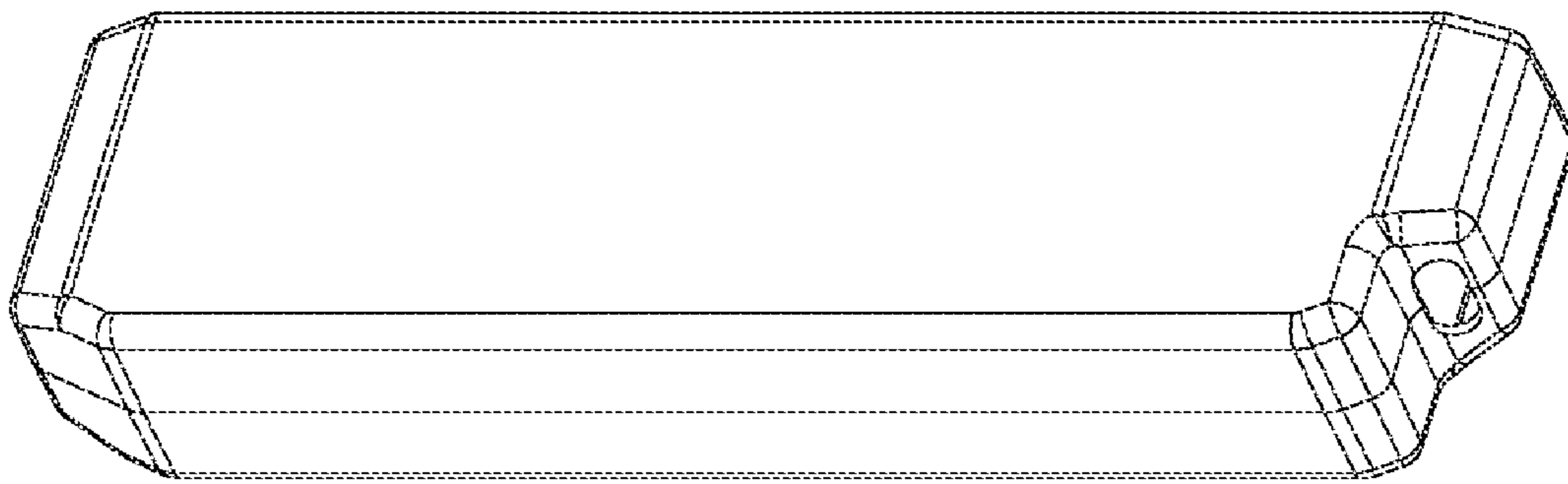

FIG. 1

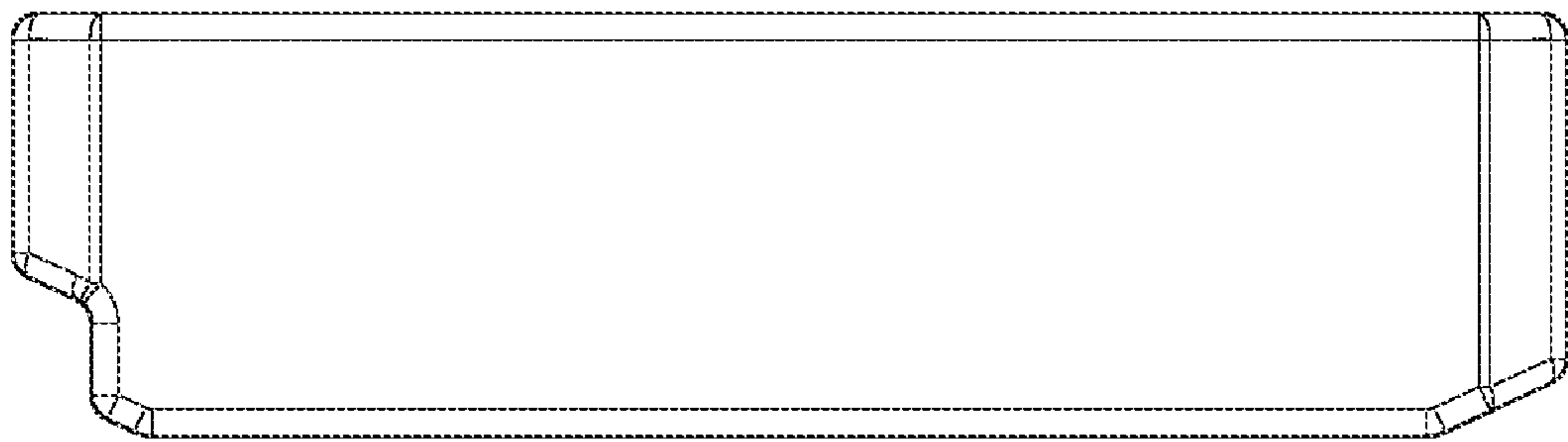

FIG. 2

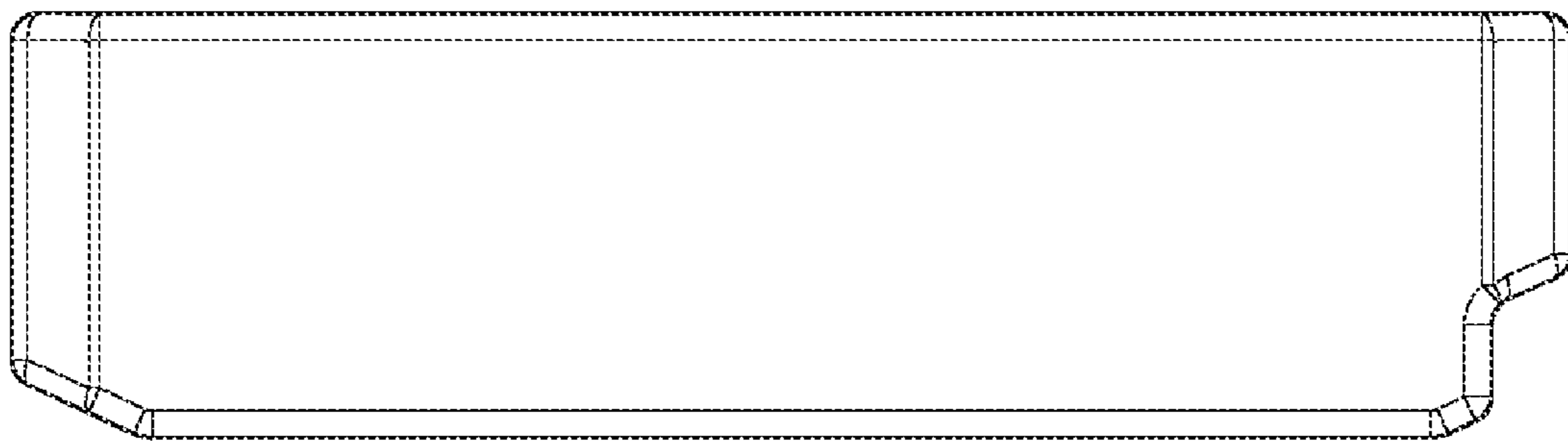

FIG. 3

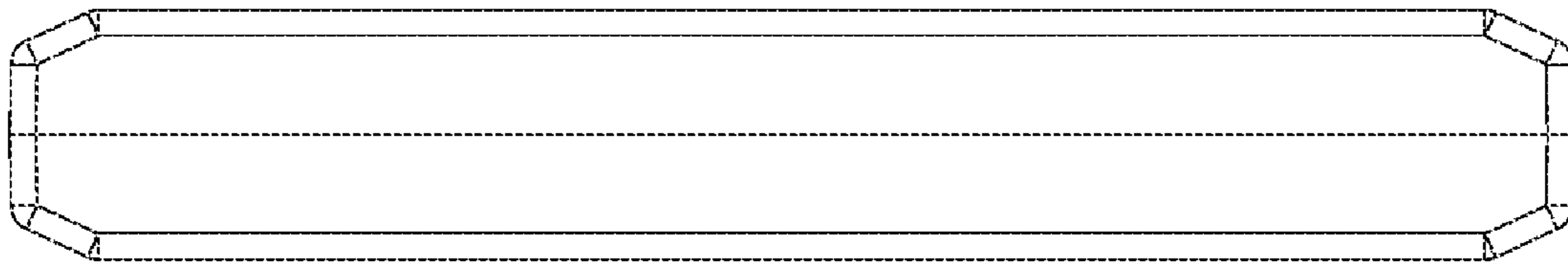

FIG. 4

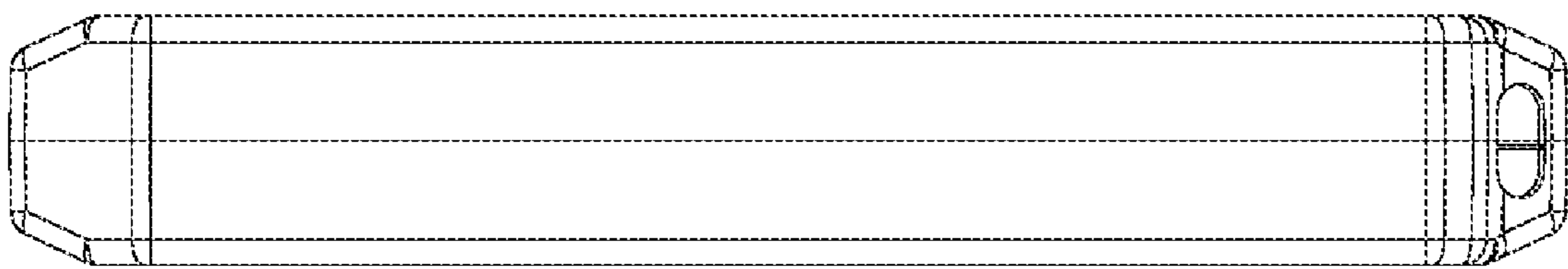

FIG. 5

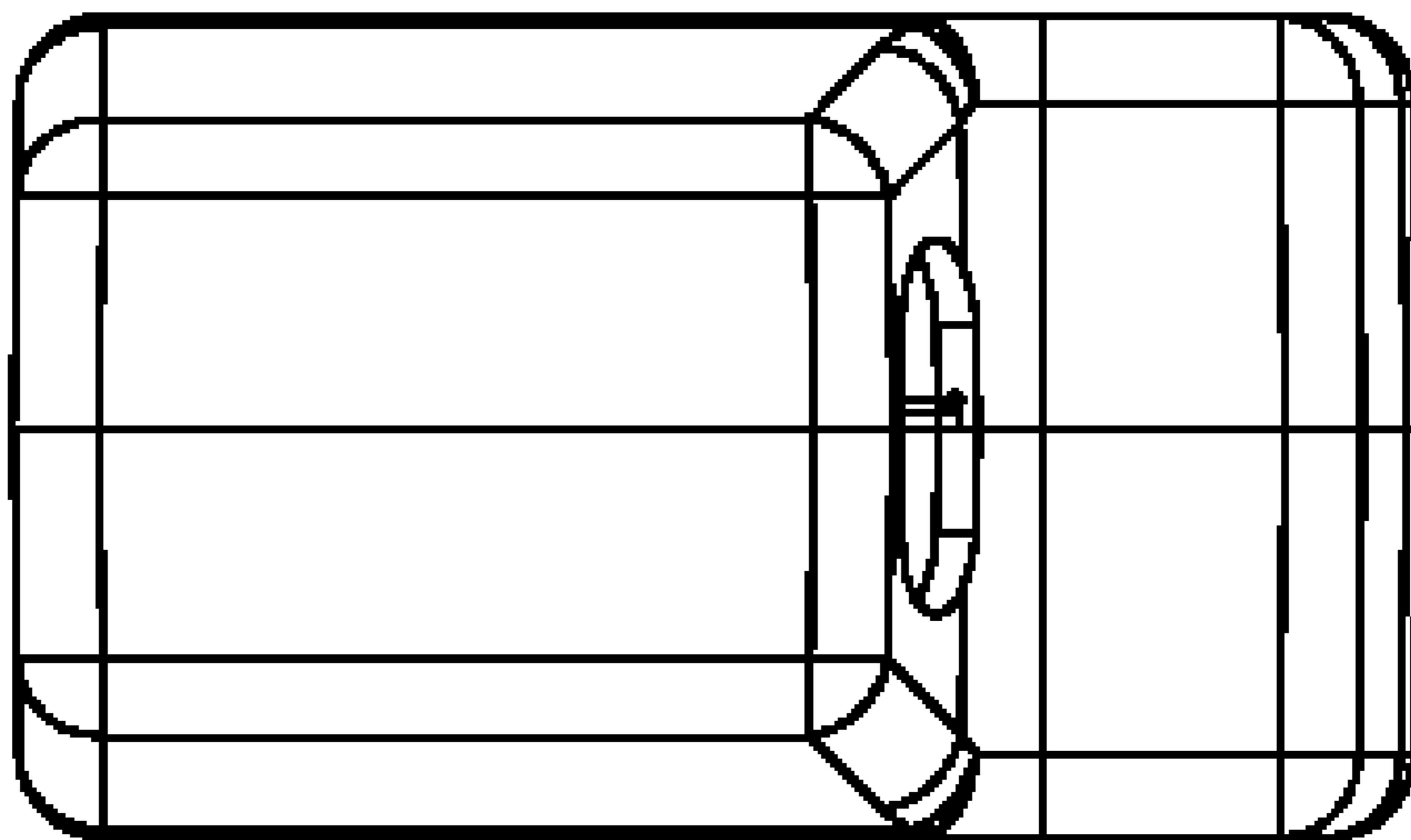

FIG. 6

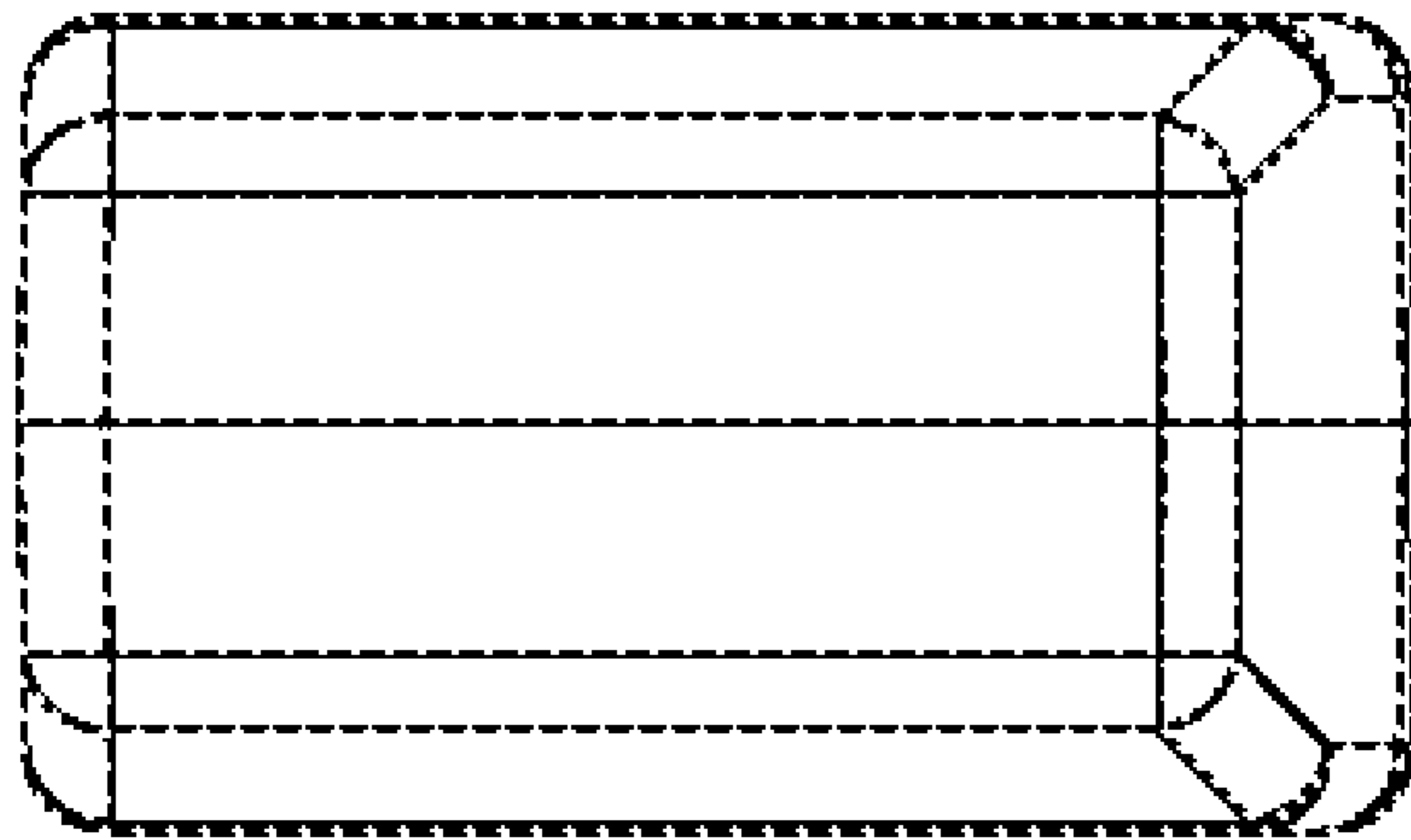

FIG. 7