



US00D631764S

(12) **United States Design Patent**  
**Furetta**

(10) **Patent No.:** **US D631,764 S**

(45) **Date of Patent:** **\*\* Feb. 1, 2011**

(54) **WRISTWATCH**

(75) Inventor: **Alessandra Furetta**, Evillard (CH)

(73) Assignee: **Rado Uhren AG (Rado Watch Co. Ltd.) (Montres Rado SA)**, Lengnau (CH)

(\*\*) Term: **14 Years**

(21) Appl. No.: **29/366,272**

(22) Filed: **Jul. 22, 2010**

(30) **Foreign Application Priority Data**

Jan. 22, 2010 (WO) ..... DM/072 949

(51) **LOC (9) Cl.** ..... **10-02**

(52) **U.S. Cl.** ..... **D10/32**

(58) **Field of Classification Search** ..... D10/30-39;  
368/276, 281, 282, 285; D11/3, 12  
See application file for complete search history.

(56) **References Cited**

**U.S. PATENT DOCUMENTS**

2,361,563	A	*	10/1944	Pellaton	.....	368/80
2,385,234	A	*	9/1945	Schmitz	.....	368/288
D178,771	S	*	9/1956	Doerwald	.....	D10/39
D186,180	S	*	9/1959	Diamond	.....	D10/39
5,023,849	A	*	6/1991	Vaucher	.....	368/15
D326,624	S	*	6/1992	Cowan	.....	D11/19
D353,108	S	*	12/1994	Rabassa	.....	D10/32
5,467,325	A	*	11/1995	Juillerat	.....	368/276
D365,526	S	*	12/1995	Gardner	.....	D10/39
D508,416	S	*	8/2005	Tang	.....	D10/30
D551,095	S	*	9/2007	Monachon	.....	D10/32
D554,003	S	*	10/2007	Journe	.....	D10/31
D562,723	S	*	2/2008	Lalo	.....	D11/94
D578,023	S	*	10/2008	Rochat	.....	D10/32
D578,900	S	*	10/2008	Nisembaum	.....	D10/32

D579,789	S	*	11/2008	Furetta	.....	D10/32
D590,275	S	*	4/2009	Monachon	.....	D10/32
D590,276	S	*	4/2009	Miloradovic	.....	D10/32
D592,977	S	*	5/2009	Furetta	.....	D10/32
D608,223	S	*	1/2010	Salanitro	.....	D10/38
D608,661	S	*	1/2010	Bulgari	.....	D10/32
D622,167	S	*	8/2010	Jorst et al.	.....	D10/39

\* cited by examiner

*Primary Examiner*—Lucy Lieberman

(74) *Attorney, Agent, or Firm*—Collen IP; Donald Ranft

(57) **CLAIM**

The ornamental design for a wristwatch, as shown and described.

**DESCRIPTION**

FIG. 1 is a front view of the first embodiment of my new, original and ornamental design for a wristwatch;

FIG. 2 is a rear view thereof;

FIG. 3 is a top view thereof;

FIG. 4 is a bottom view thereof;

FIG. 5 is a right side view thereof;

FIG. 6 is a left side view thereof;

FIG. 7 is front perspective view thereof;

FIG. 8 is a front view of the second embodiment of my new, original and ornamental design for a wristwatch;

FIG. 9 is a rear view thereof;

FIG. 10 is a top view thereof;

FIG. 11 is a bottom view thereof;

FIG. 12 is a right side view thereof;

FIG. 13 is a left side view thereof; and,

FIG. 14 is a front perspective view thereof.

**1 Claim, 8 Drawing Sheets**

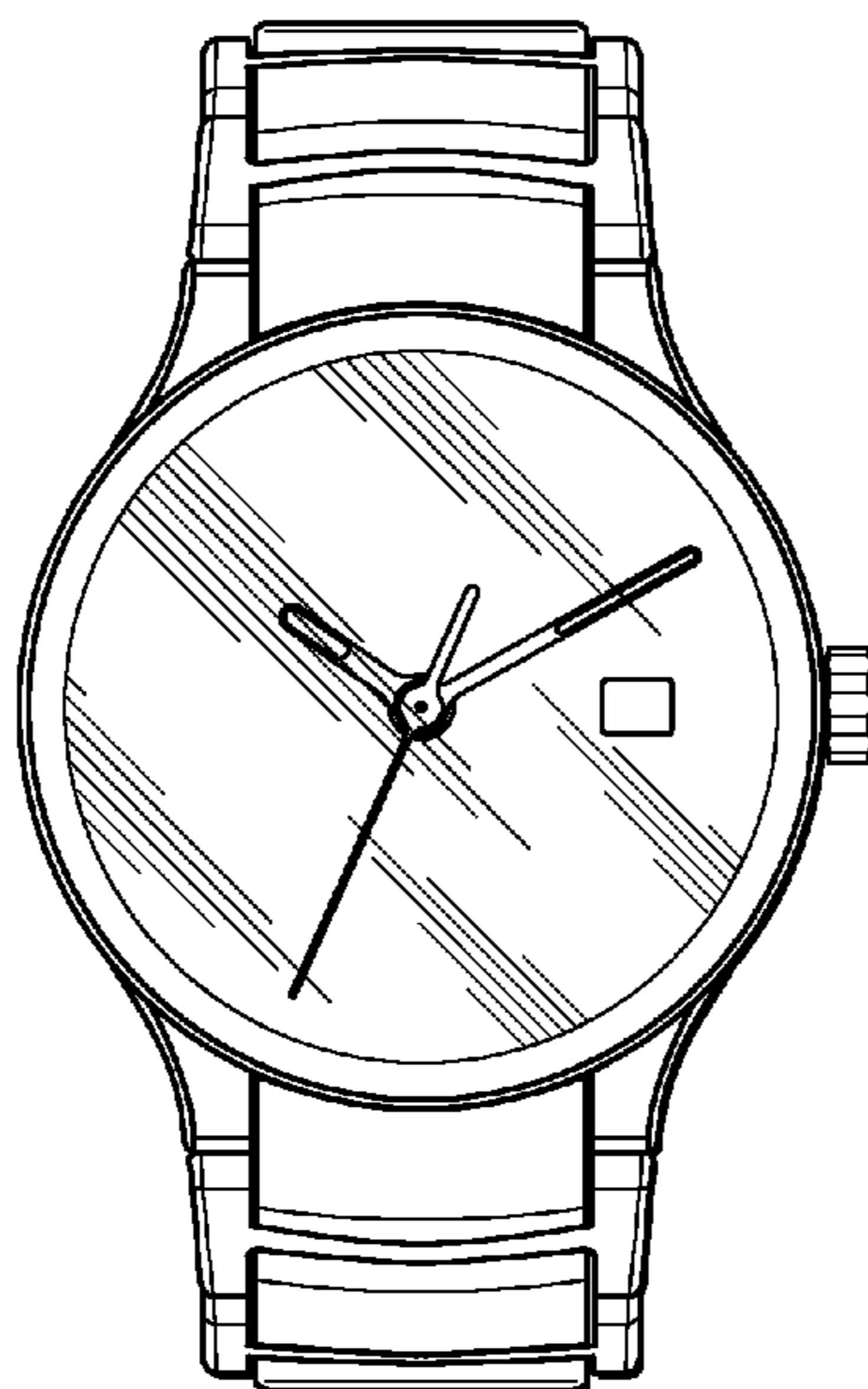

Fig. 1

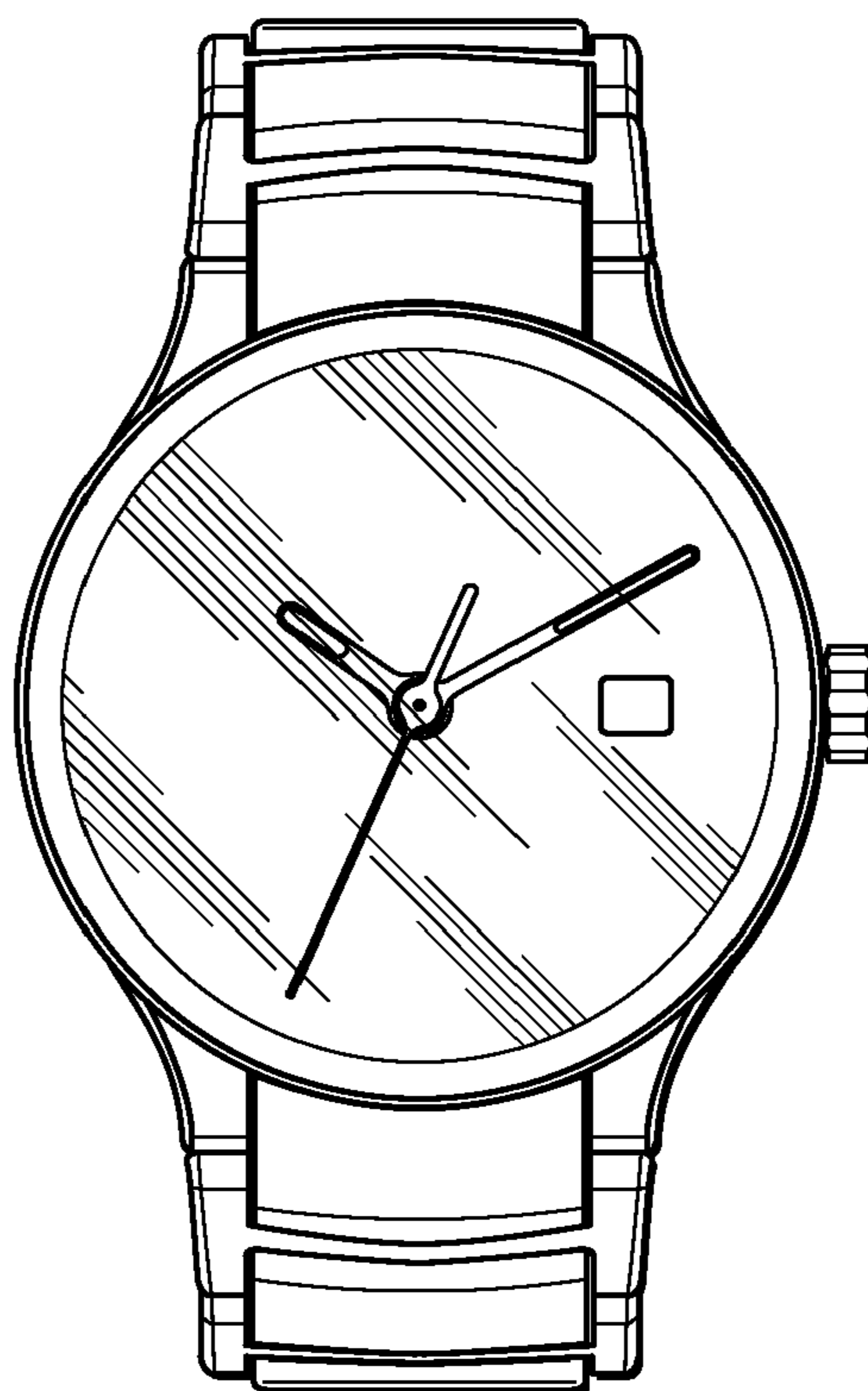

Fig. 2

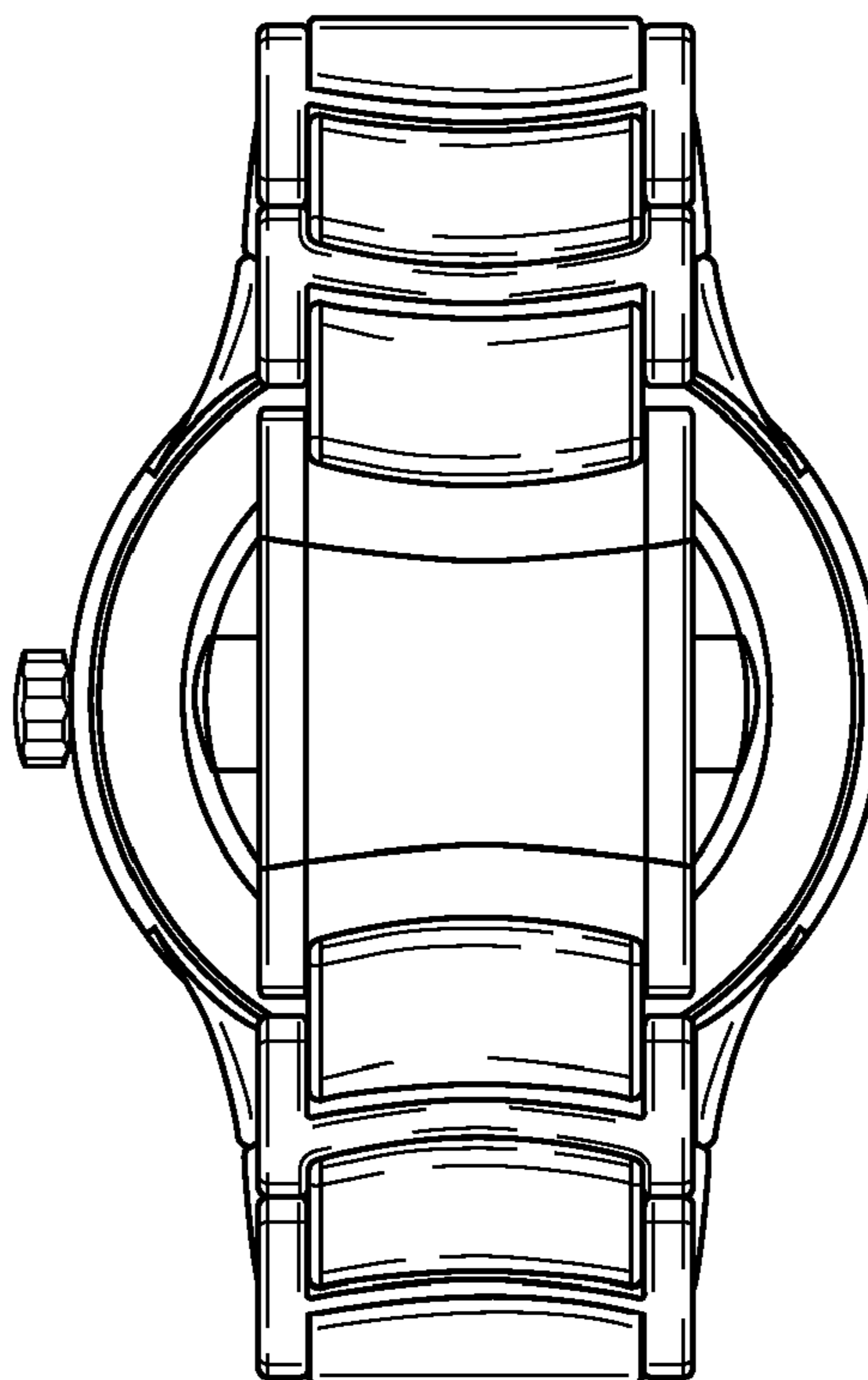

Fig. 3

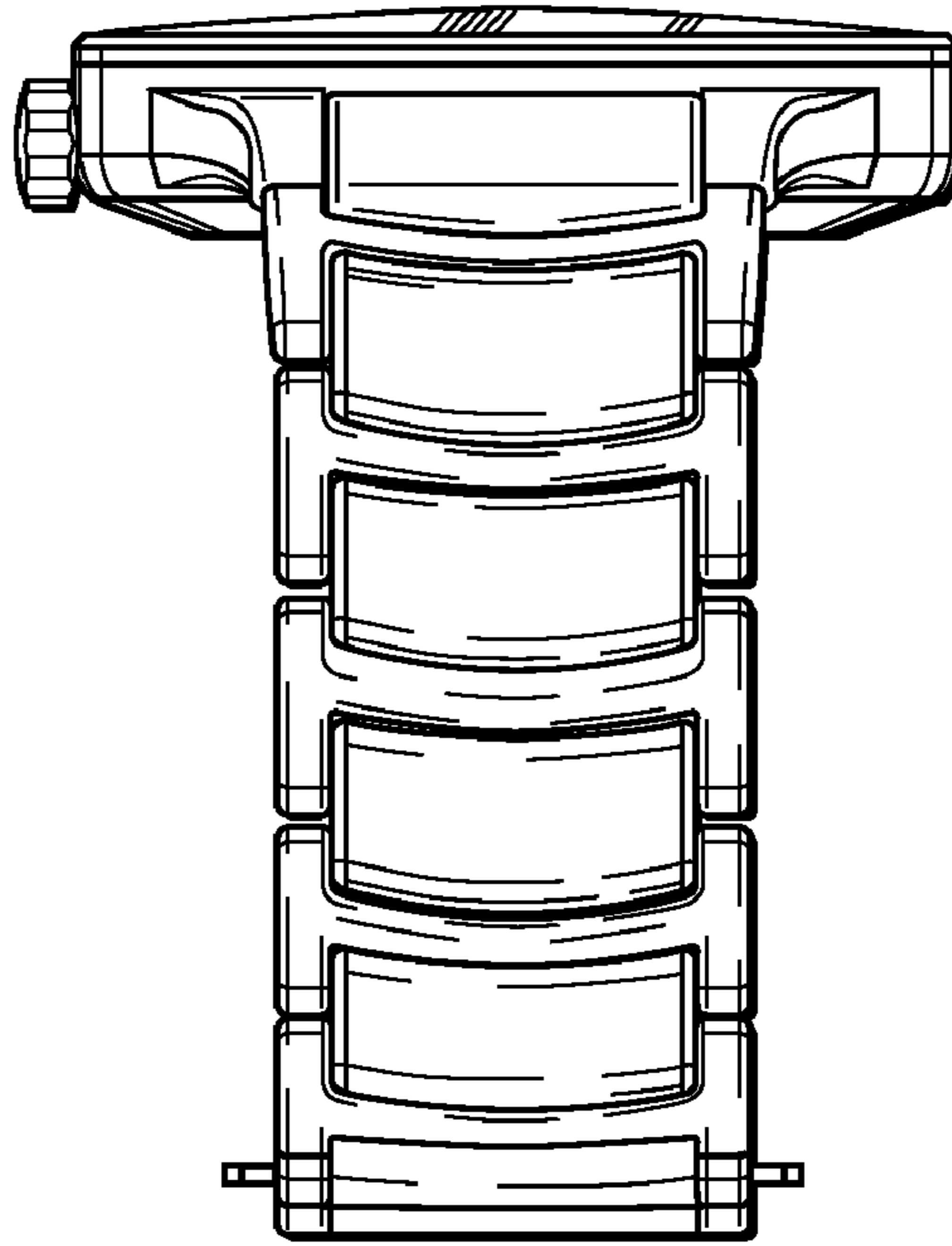

Fig. 4

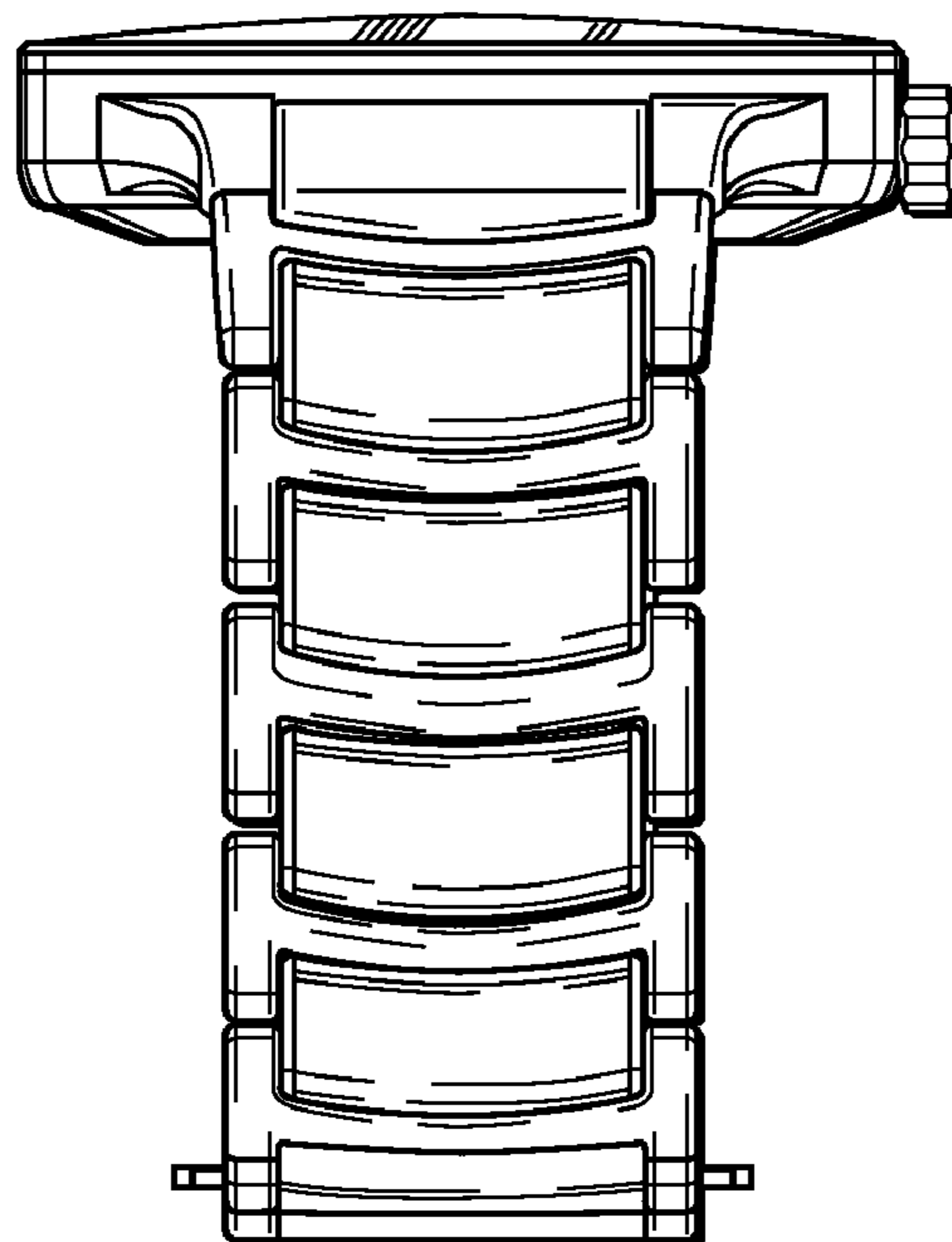

Fig. 5

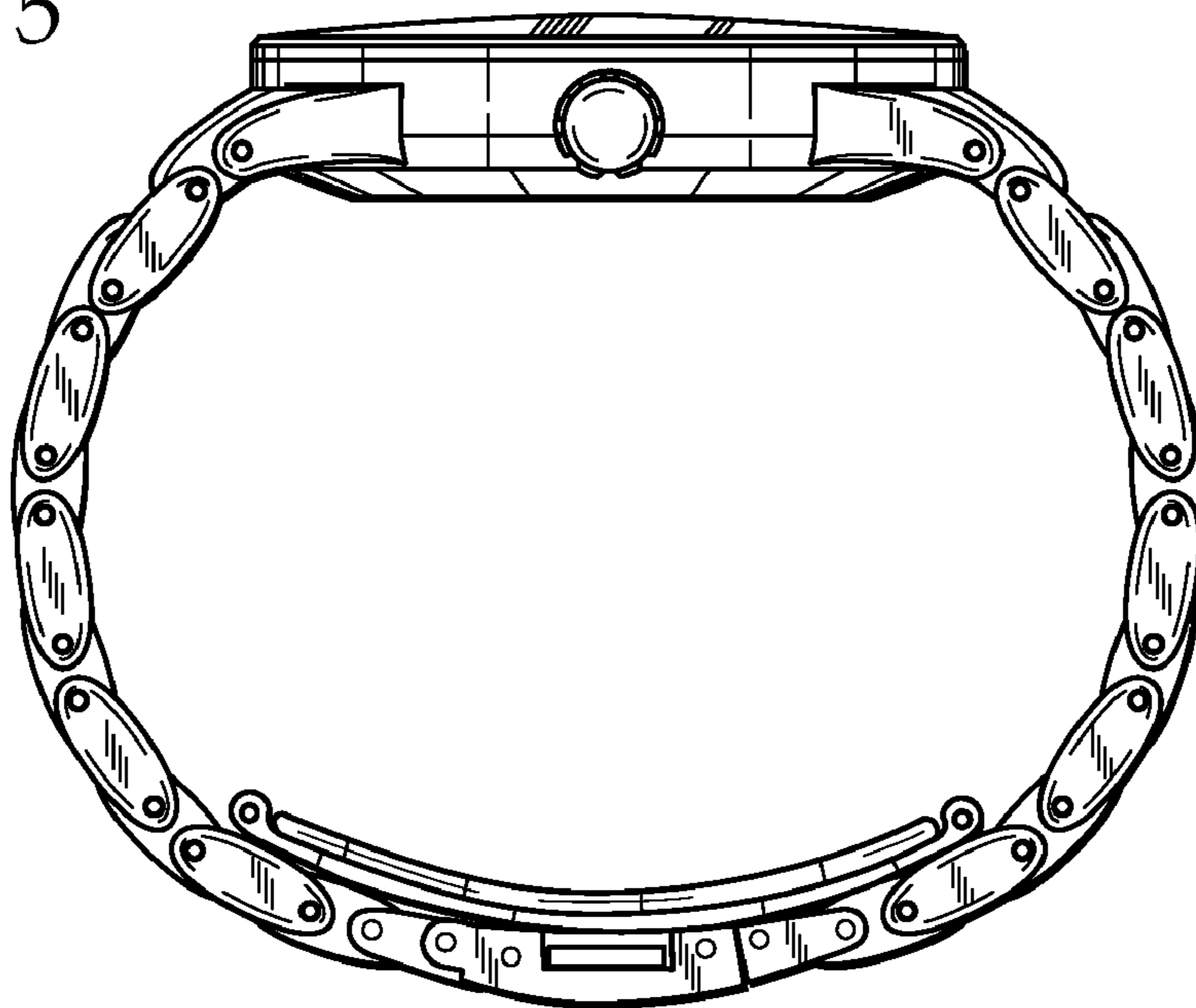

Fig. 6

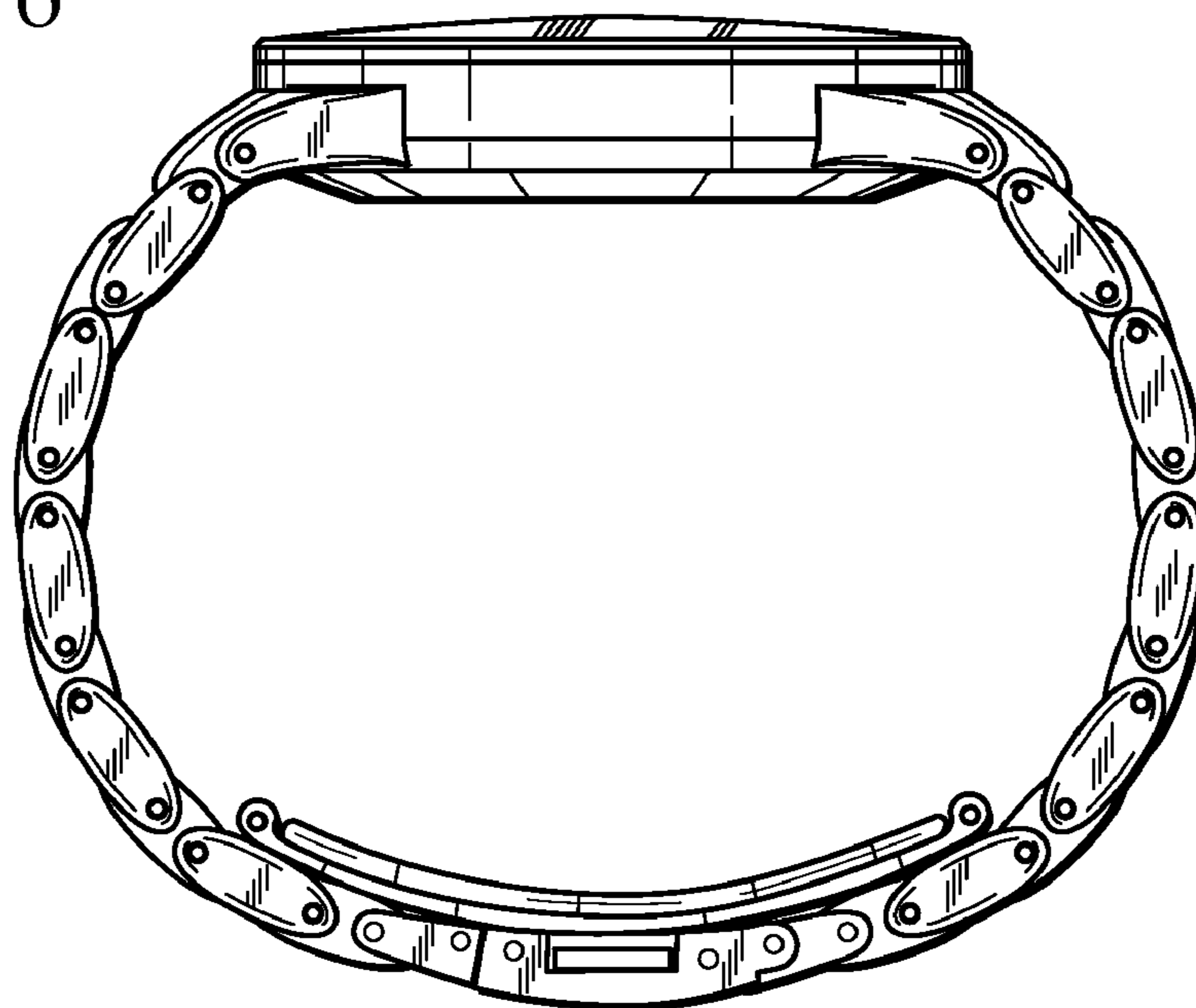



Fig. 7

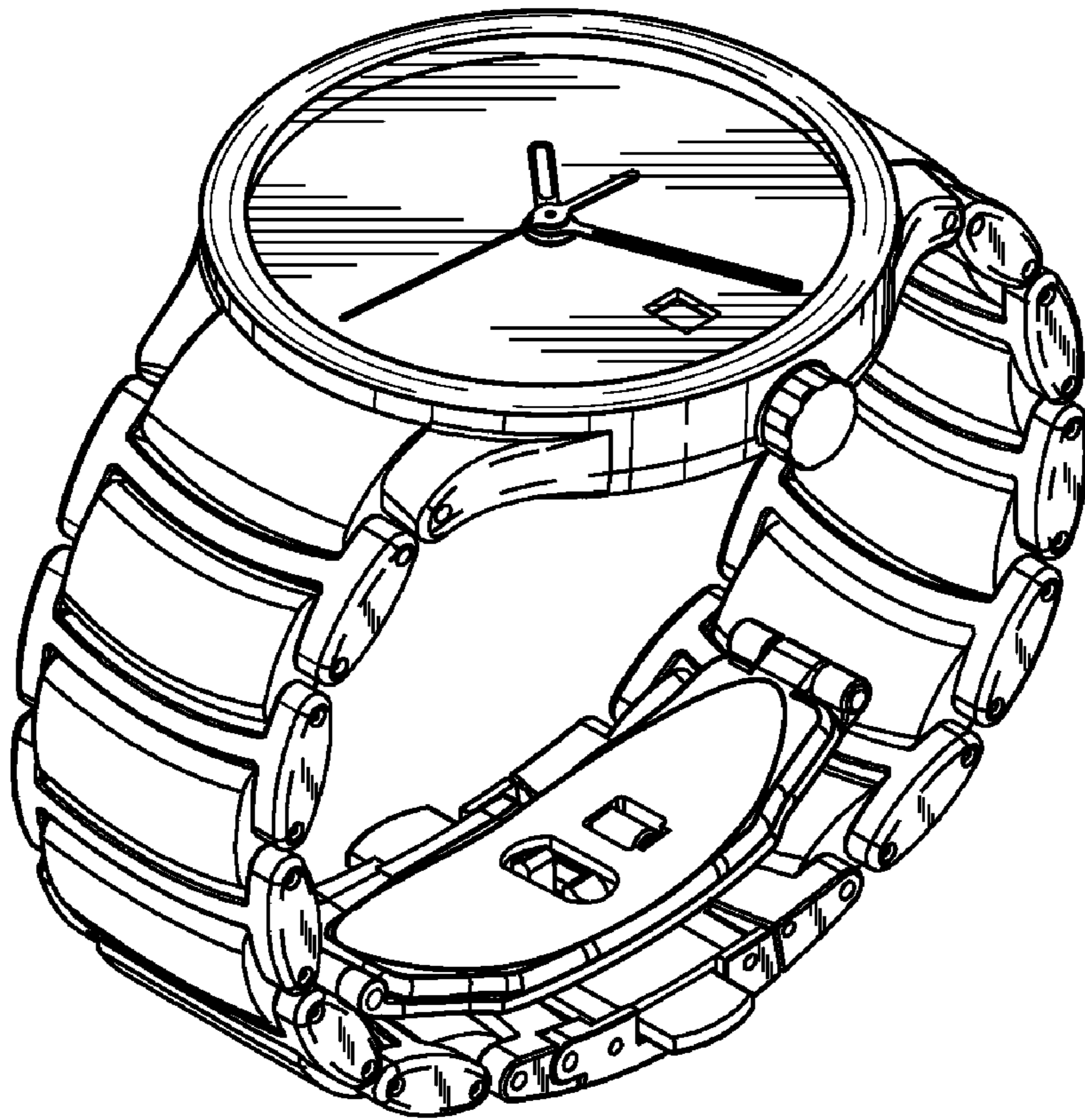

Fig. 8

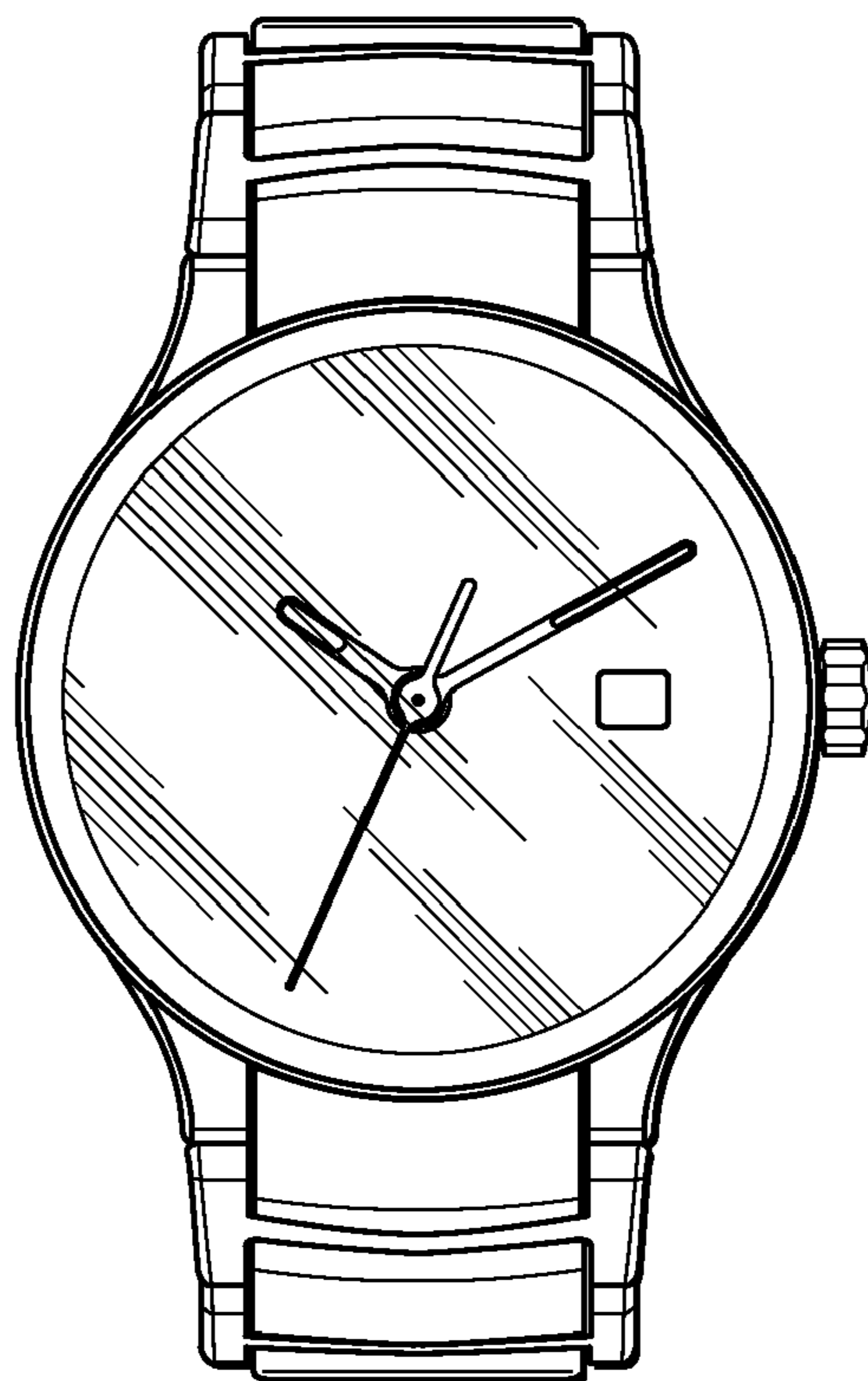

Fig. 9

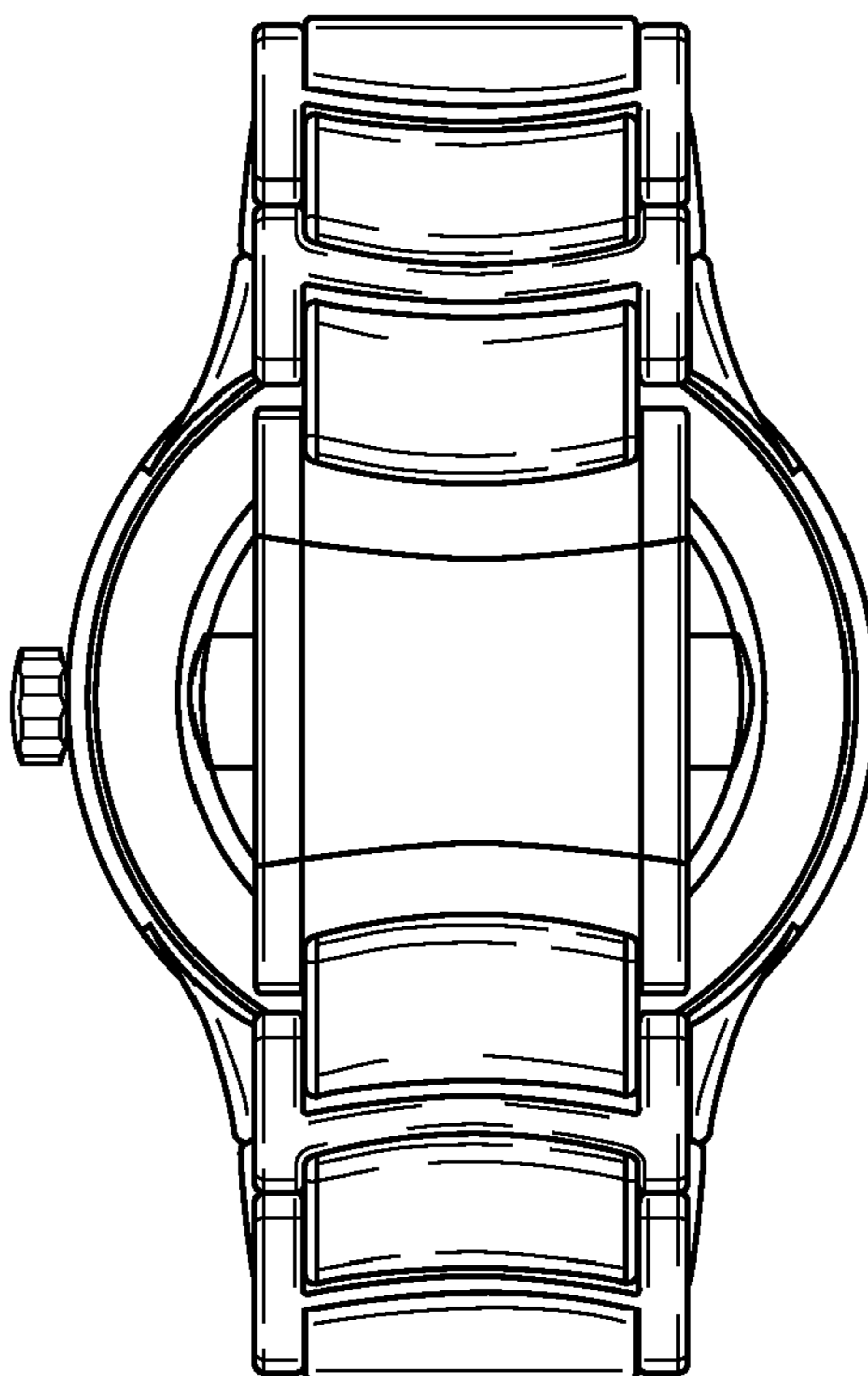

Fig. 10

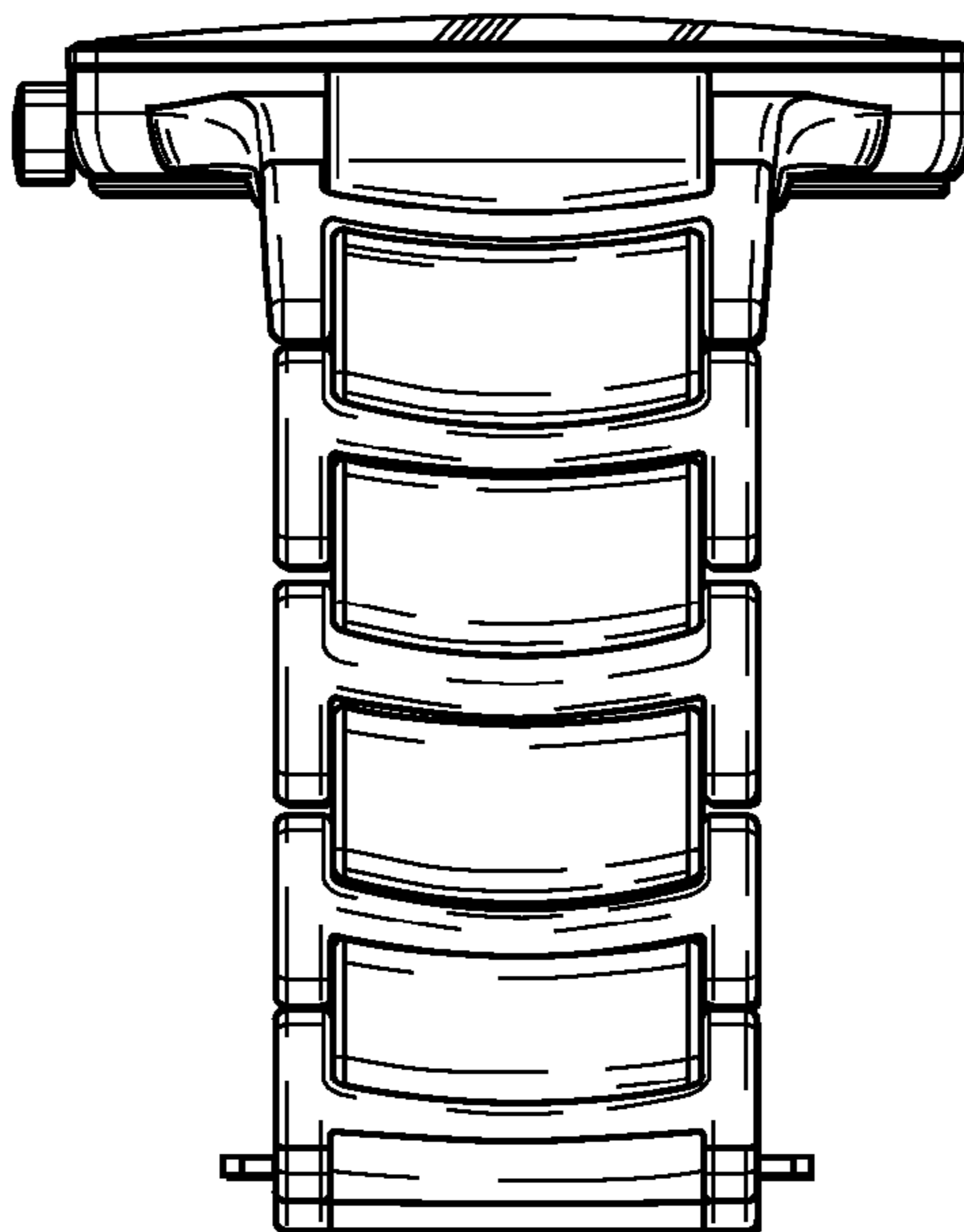

Fig. 11

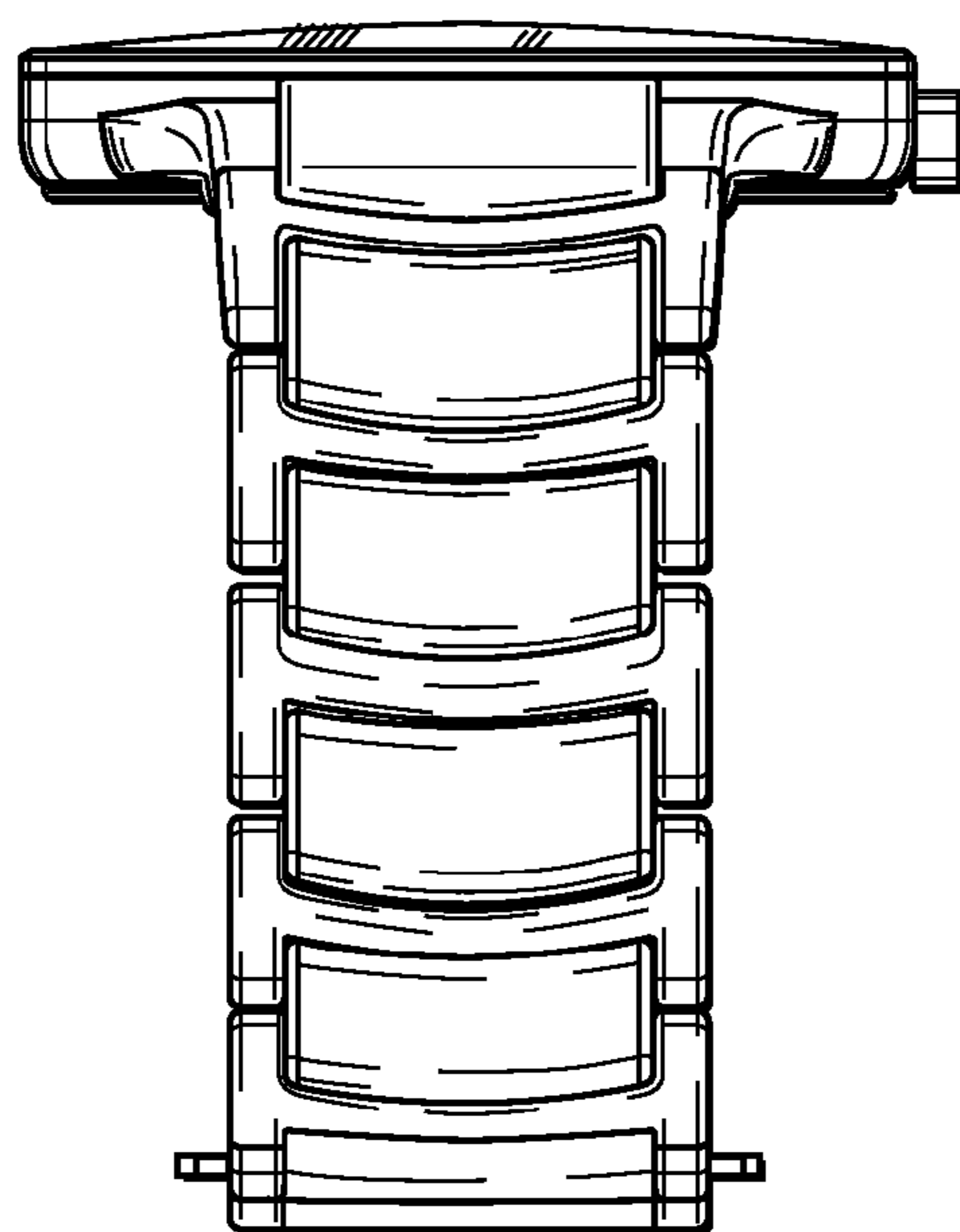

Fig. 12

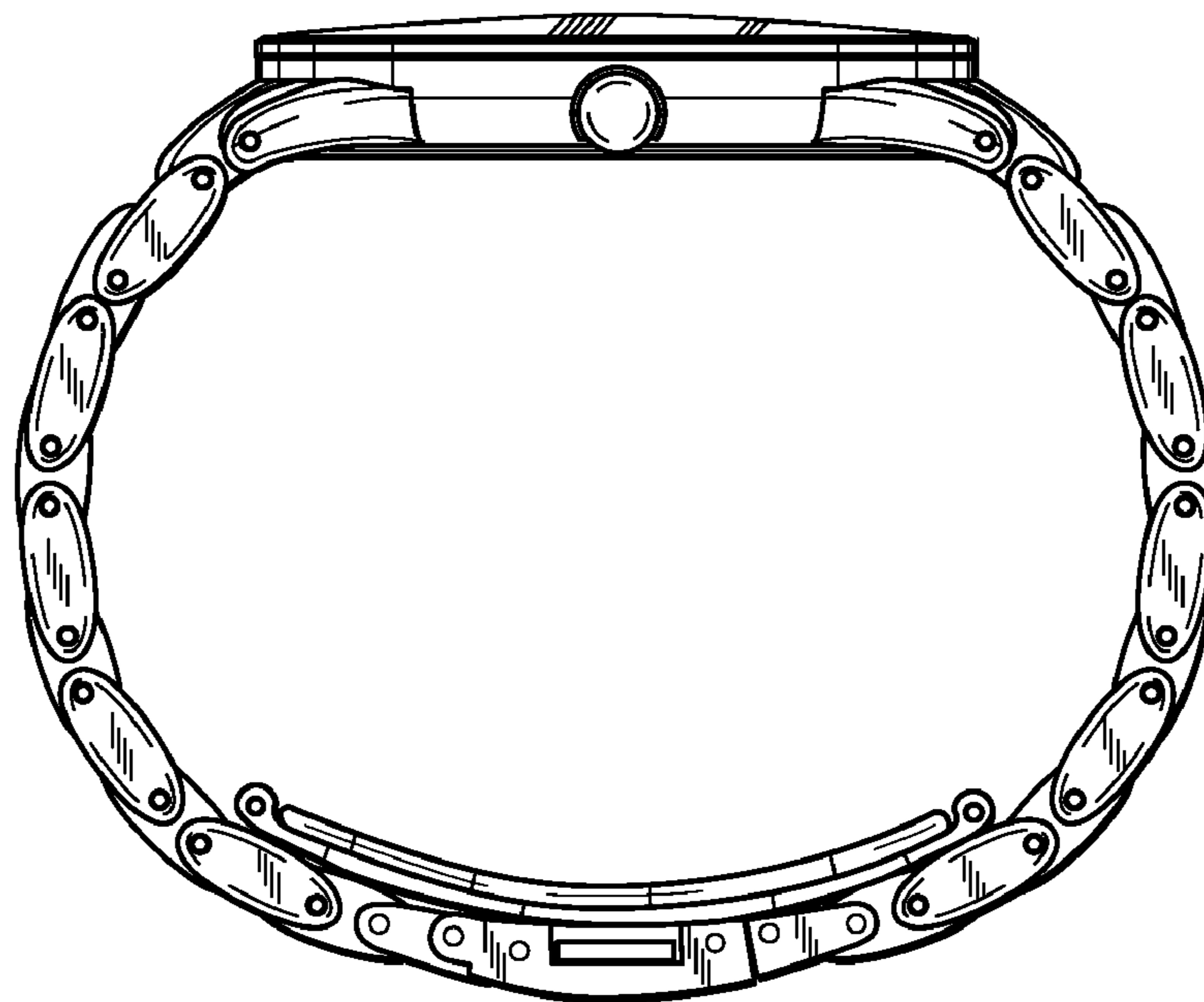

Fig. 13

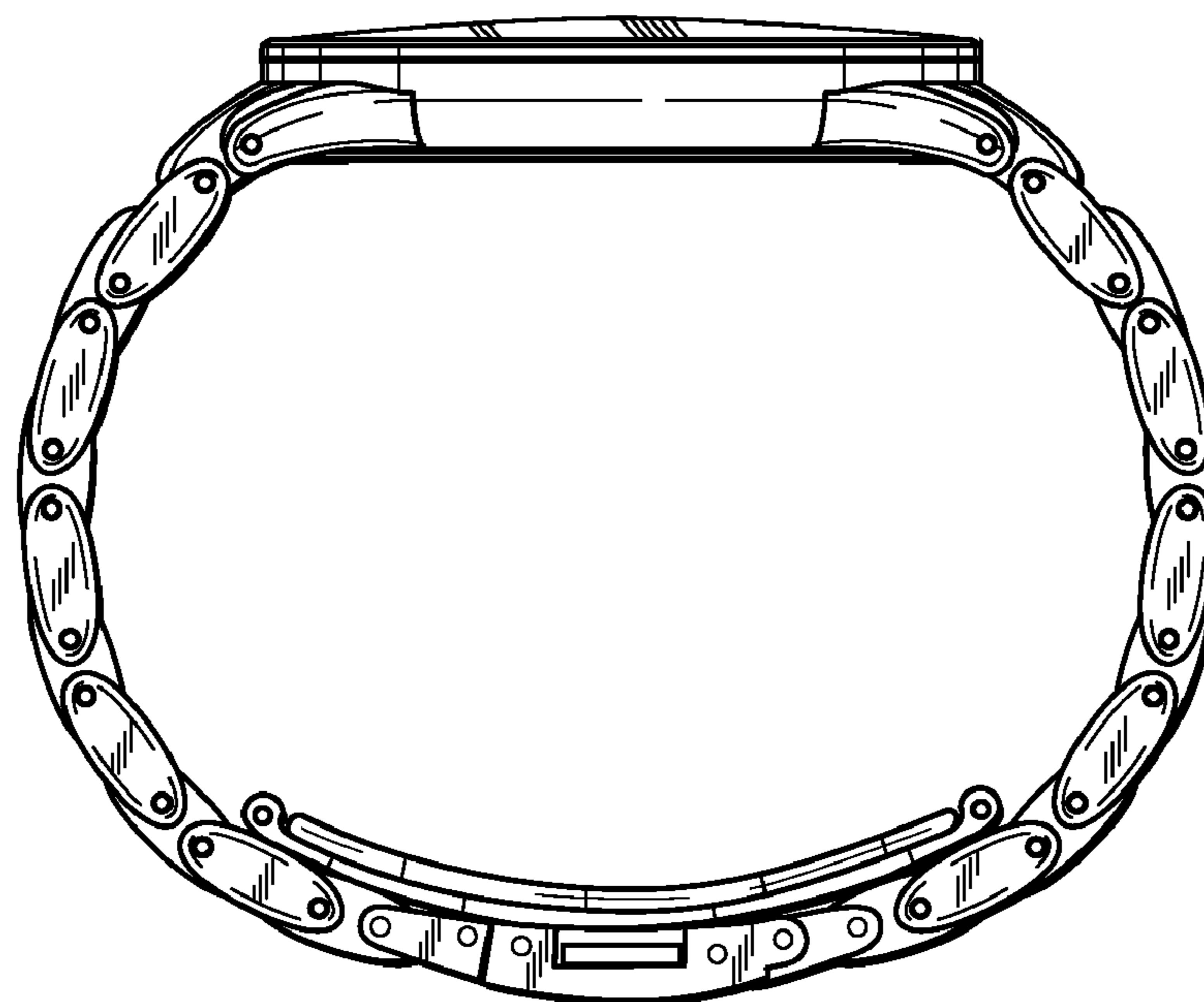



Fig. 14

