



US00D631729S

(12) **United States Design Patent**
Bucci

(10) **Patent No.:** **US D631,729 S**
(45) **Date of Patent:** **** Feb. 1, 2011**

(54) **DEVICE FOR SUPPORTING AN OBJECT**

(76) Inventor: **Michael Bucci**, 5770 Oak Mill Ct., Glen Allen, VA (US) 23059

(**) Term: **14 Years**

(21) Appl. No.: **29/355,157**

(22) Filed: **Feb. 3, 2010**

Related U.S. Application Data

(60) Continuation of application No. 29/352,511, filed on Dec. 22, 2009, now Pat. No. Des. 613,582, which is a continuation of application No. 29/343,675, filed on Sep. 17, 2009, now Pat. No. Des. 609,077, which is a division of application No. 29/334,086, filed on Mar. 20, 2009, now Pat. No. Des. 603,245, which is a continuation-in-part of application No. 29/326,489, filed on Oct. 20, 2008, now Pat. No. Des. 602,341, which is a continuation-in-part of application No. 29/283,426, filed on Aug. 14, 2007, now Pat. No. Des. 581,251, and a continuation-in-part of application No. 29/295,012, filed on Sep. 20, 2007, now Pat. No. Des. 581,254.

(51) **LOC (9) Cl.** **08-05**

(52) **U.S. Cl.** **D8/354; D21/505**

(58) **Field of Classification Search** D8/349, D8/354, 380, 382, 388, 400, 402, 499; D21/505, D21/803, 369, 373, 386, 388, 396; D10/109, D10/113; D20/10, 39-43; D1/105; 116/28 R, 116/63 R, 63 P, 63 T, 63 C, 209; 440/584, 440/606, 607, 608, 311, 312; 273/113, 153 P, 273/153 R, 153 S, 155, 157 R, 260; 446/69, 446/70, 121, 122, 125, 126; 248/346.01, 248/546, 694, 126, 176.1; 434/99, 102, 211, 434/403; 404/4-16; 405/21, 29; D30/106; D9/431, 432

See application file for complete search history.

(56) **References Cited**

U.S. PATENT DOCUMENTS

1,216,840 A 2/1917 Ramsey et al.

1,522,306 A	1/1925	Lewis	
2,483,734 A	10/1944	Neal	
2,800,099 A	7/1957	Baker	
2,808,803 A	10/1957	Weig	
2,843,971 A *	7/1958	Gardellin 446/126
D206,635 S	1/1967	Walter	
3,565,442 A	2/1971	Klein	
3,608,906 A	9/1971	Odier	
3,659,360 A	5/1972	Zeischegg	
3,666,607 A	5/1972	Weissman	
3,779,554 A	12/1973	Brix	
3,782,029 A	1/1974	Bardot	
3,800,735 A	4/1974	Simpson	
D231,787 S	6/1974	Burnley	
3,840,234 A *	10/1974	Felsten 273/113

(Continued)

Primary Examiner—Cynthia M Chin
(74) *Attorney, Agent, or Firm*—Brian J. Teague

(57) **CLAIM**

I claim the ornamental design for a device for supporting an object, as shown and described.

DESCRIPTION

FIG. 1 is a perspective view of one embodiment of a device for supporting an object showing the new design;
FIG. 2 is a front elevational view thereof;
FIG. 3 is a rear elevational view thereof;
FIG. 4 is a top view thereof;
FIG. 5 is a bottom view thereof;
FIG. 6 is a perspective view of an alternative embodiment of a device for supporting an object;
FIG. 7 is a front elevational view thereof;
FIG. 8 is a right side elevational view thereof;
FIG. 9 is a rear elevational view thereof;
FIG. 10 is a left side elevational view thereof;
FIG. 11 is a top view thereof; and,
FIG. 12 is a bottom view thereof.

1 Claim, 7 Drawing Sheets

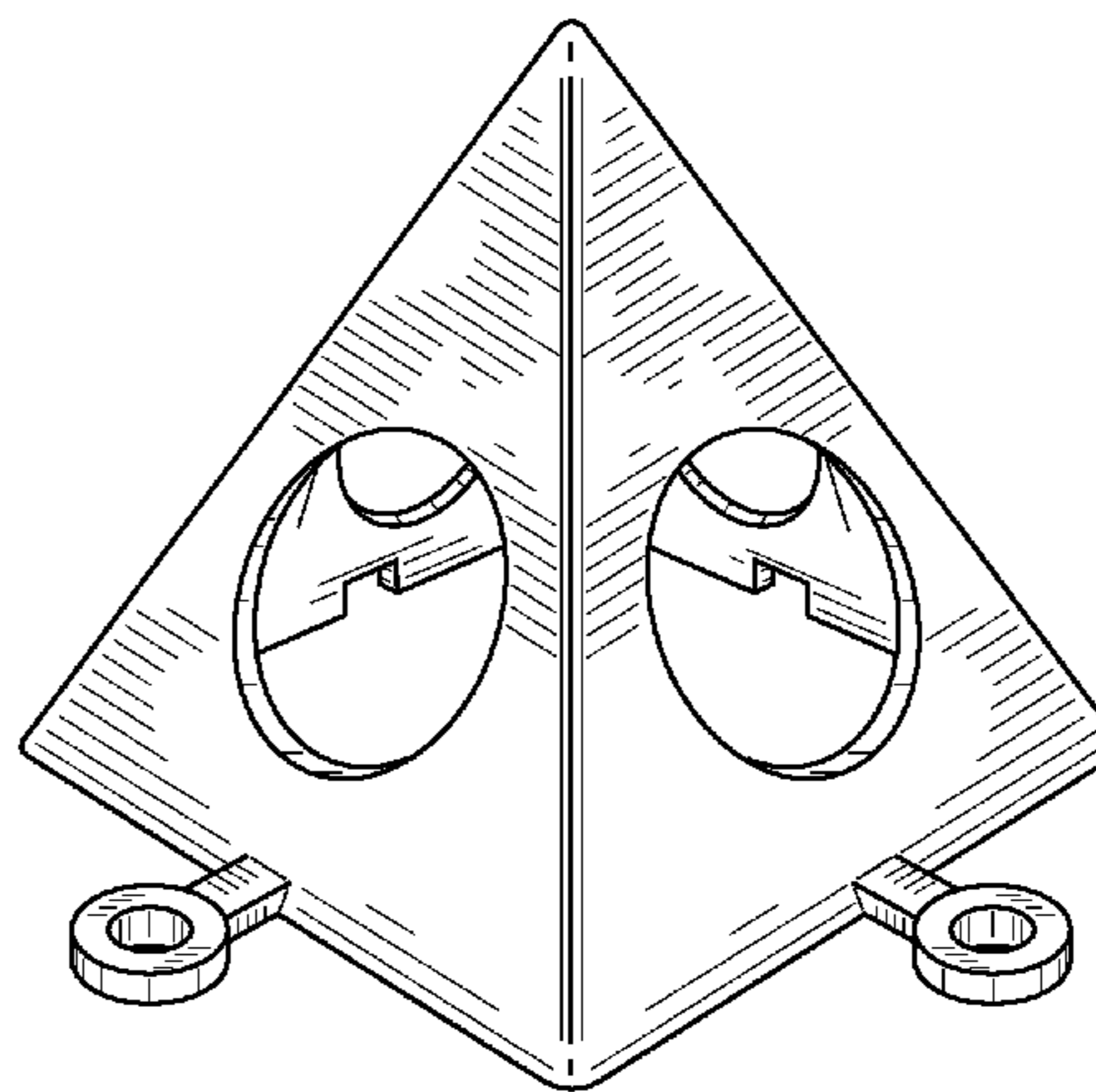
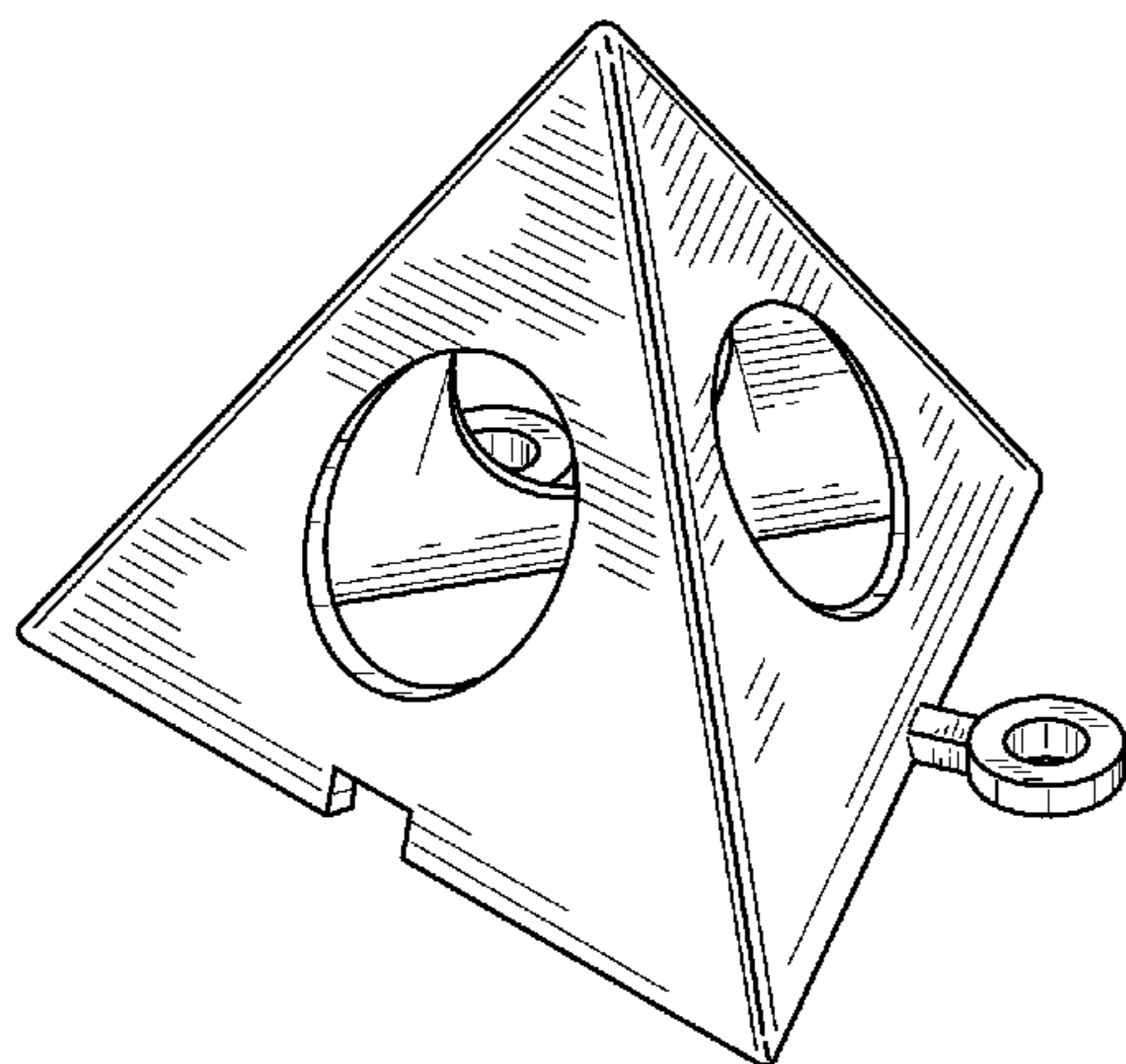

US D631,729 S

Page 2

U.S. PATENT DOCUMENTS

3,940,100 A	2/1976	Haug	D367,384 S	2/1996	DiFranco et al.
3,974,611 A	8/1976	Satterwaite	D373,528 S *	9/1996	Ser Tuen Wei D9/431
D242,640 S	12/1976	Mosher	5,601,645 A	2/1997	Nonomura et al.
4,026,087 A	5/1977	White	5,615,429 A	4/1997	Williams
D245,279 S	8/1977	Hollendonner	D389,550 S	1/1998	Williams
4,063,725 A *	12/1977	Snyder 273/155	5,769,598 A	6/1998	MacNeil
D250,174 S	11/1978	Hedgecock	5,788,933 A	8/1998	Peddicord
D250,687 S	1/1979	Robelen	D403,981 S	1/1999	Dillard
4,159,112 A	6/1979	O'Brian et al.	5,895,304 A	4/1999	Dixon
D261,373 S	10/1981	Fisher	D409,687 S	5/1999	Mak
D262,901 S	2/1982	Vukadinovic	5,945,161 A	8/1999	Hashimoto et al.
D263,255 S	3/1982	Zima	5,947,786 A	9/1999	Glick
4,317,654 A	3/1982	Wahl	D417,314 S *	11/1999	Smith, Jr. D30/106
4,323,245 A	4/1982	Beaman	D417,329 S	11/1999	Ramadei
4,345,761 A	8/1982	China	D423,342 S *	4/2000	Popesco D21/505
4,354,288 A	10/1982	Dennis	6,224,453 B1 *	5/2001	McKinley, Jr. et al. 446/69
D267,588 S	1/1983	Goodell	D443,900 S *	6/2001	Eklund D21/369
D268,315 S	3/1983	Kirk	6,247,424 B1	6/2001	Huang
D272,841 S	2/1984	Matsumoto	D445,721 S	7/2001	McLeish et al.
D273,095 S	3/1984	Schulze	6,425,646 B1	7/2002	Andrews
4,461,480 A	7/1984	Mitchell	D478,194 S	8/2003	McGinty
D275,889 S	10/1984	Nelson	D482,111 S	11/2003	Laferriere et al.
4,558,866 A	12/1985	Alford	D483,200 S	12/2003	Udommahuntisuk
4,761,137 A	8/1988	Taylor et al.	D493,198 S	7/2004	Starkel
4,848,263 A	7/1989	Grimm	6,976,768 B2	12/2005	Hewson
D305,343 S	1/1990	Epperson et al.	D514,463 S	2/2006	Levine
4,934,701 A	6/1990	Ting	D514,971 S	2/2006	Burch et al.
D314,018 S	1/1991	Rosenthal	D515,683 S	2/2006	LaBlaine
D315,186 S	3/1991	Peterson	7,047,681 B2	5/2006	Perelli et al.
D315,773 S	3/1991	Peterson	D522,348 S	6/2006	Hansen
D325,168 S	4/1992	Dlabac	D529,377 S	10/2006	Heiss
D325,615 S	4/1992	Matsch	D551,116 S	9/2007	Devory, Jr.
5,184,822 A *	2/1993	Bognar et al. 273/153 R	D562,915 S	2/2008	Davis
5,199,375 A	4/1993	Johson	D569,076 S	5/2008	Lebrand
5,259,695 A *	11/1993	Mostkoff 405/29	D574,293 S	8/2008	Devory, Jr.
5,297,012 A	3/1994	Fletcher	D574,440 S	8/2008	Goodrich
D351,623 S	10/1994	Seiler	D579,369 S	10/2008	Spataro
5,354,224 A	10/1994	Ishiyama	D597,432 S	8/2009	Auberger
5,375,845 A	12/1994	Cooter et al.	2004/0159280 A1	8/2004	Mohelsky et al.
5,400,998 A	3/1995	Ma	2005/0014112 A1	1/2005	Fentress
5,407,201 A	4/1995	Whitehurst	2006/0157544 A1	7/2006	Chomic, Jr. et al.
D367,119 S	2/1996	Trunk			

* cited by examiner

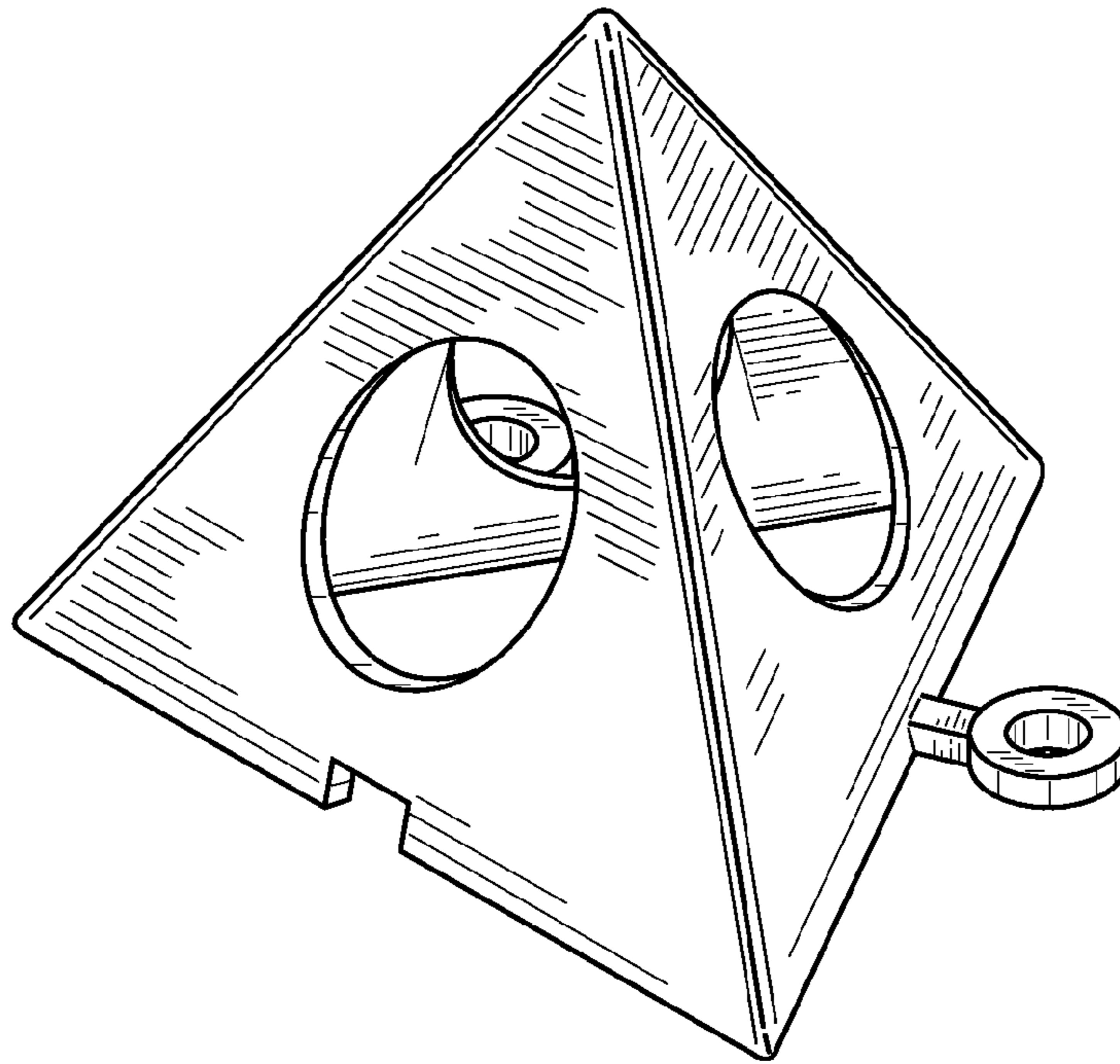

FIG. 1

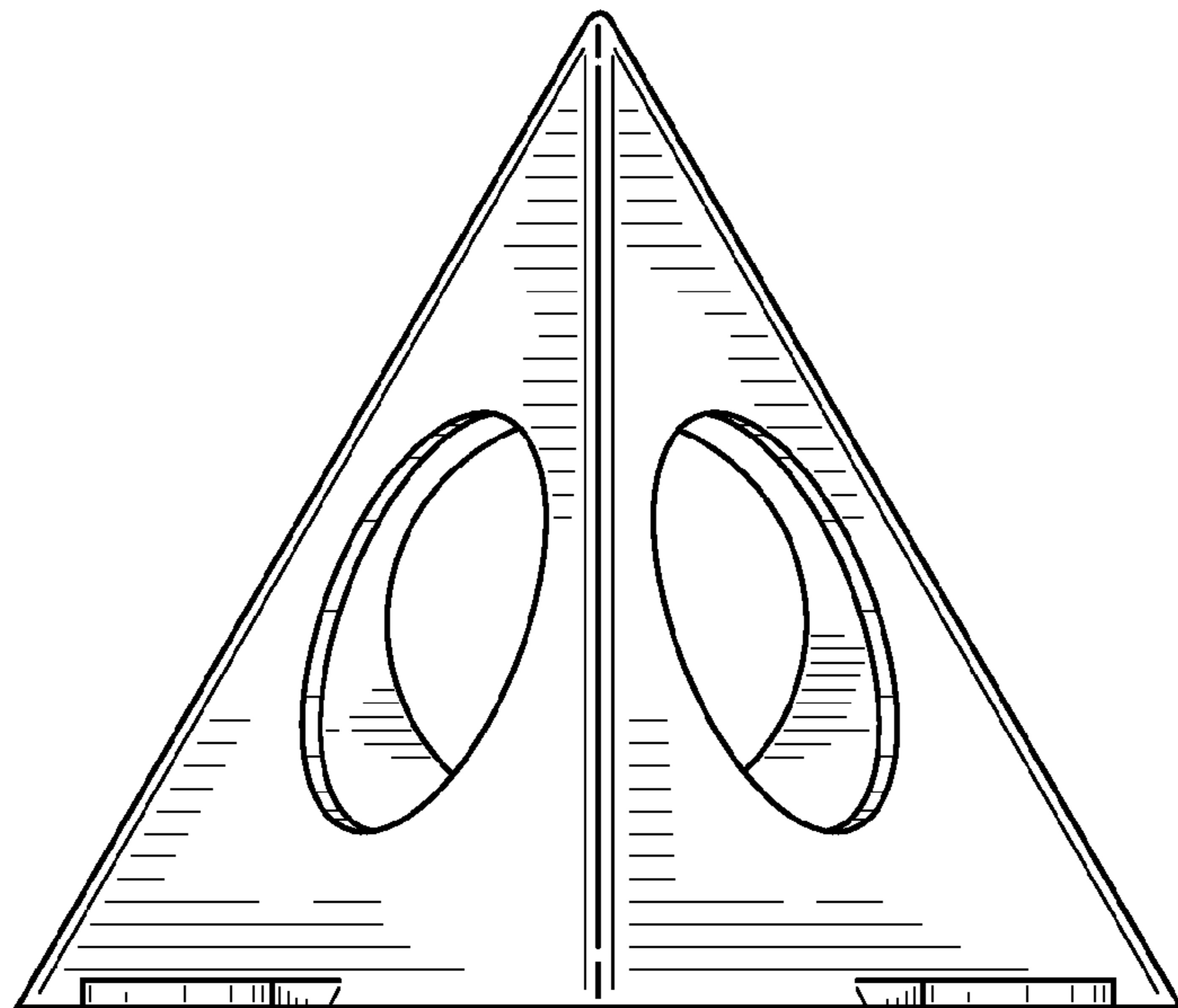

FIG. 2

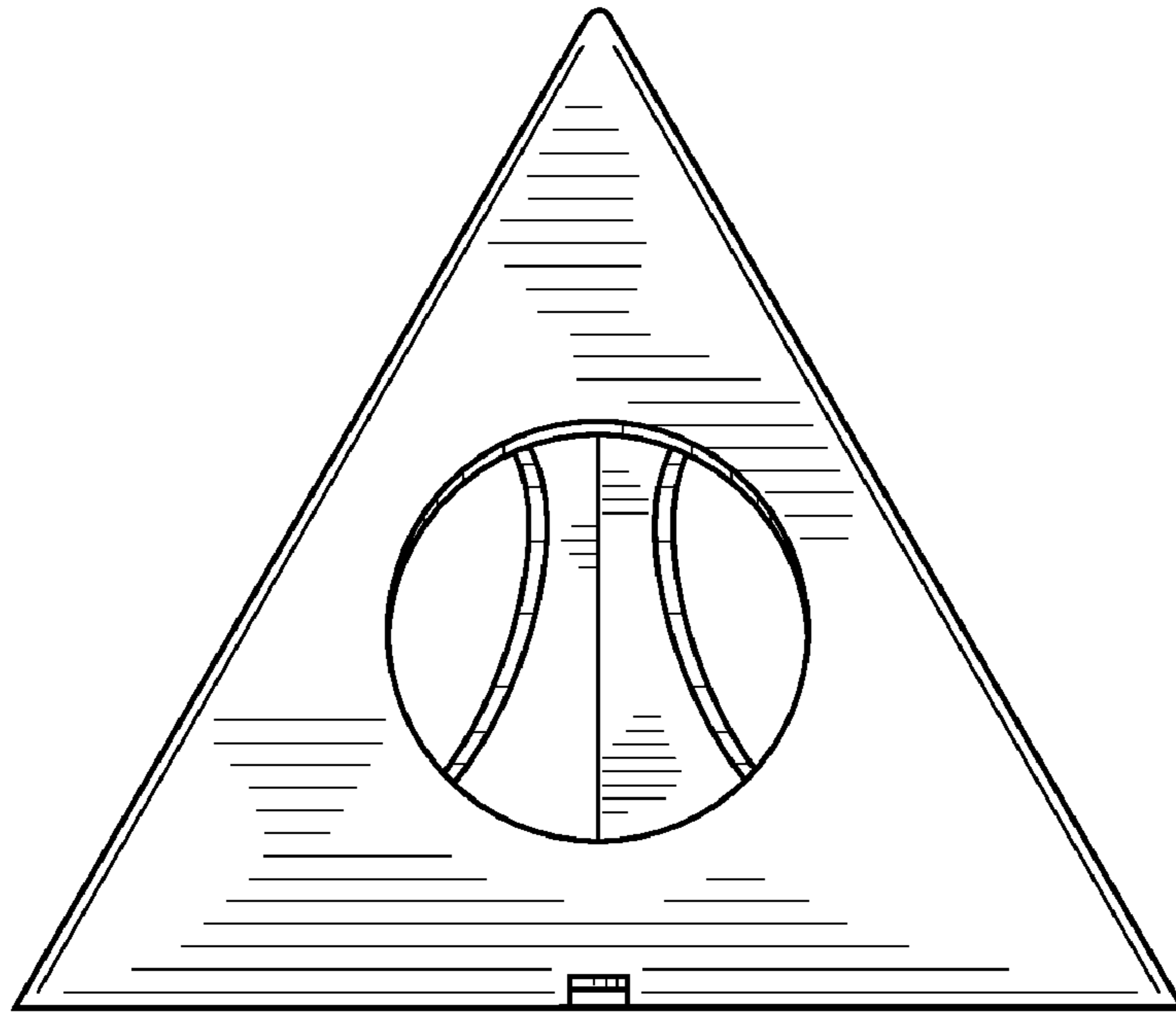

FIG. 3

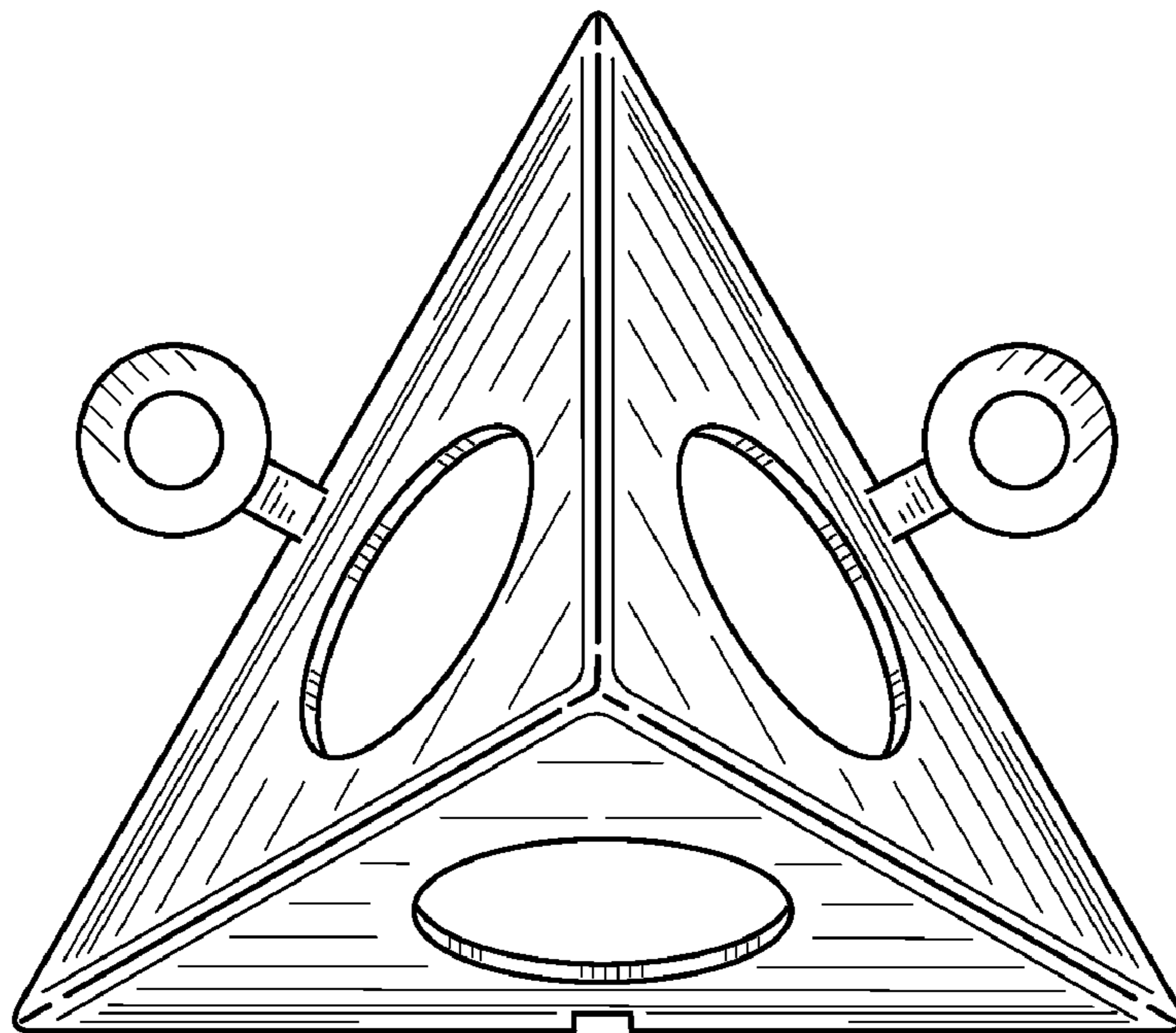

FIG. 4

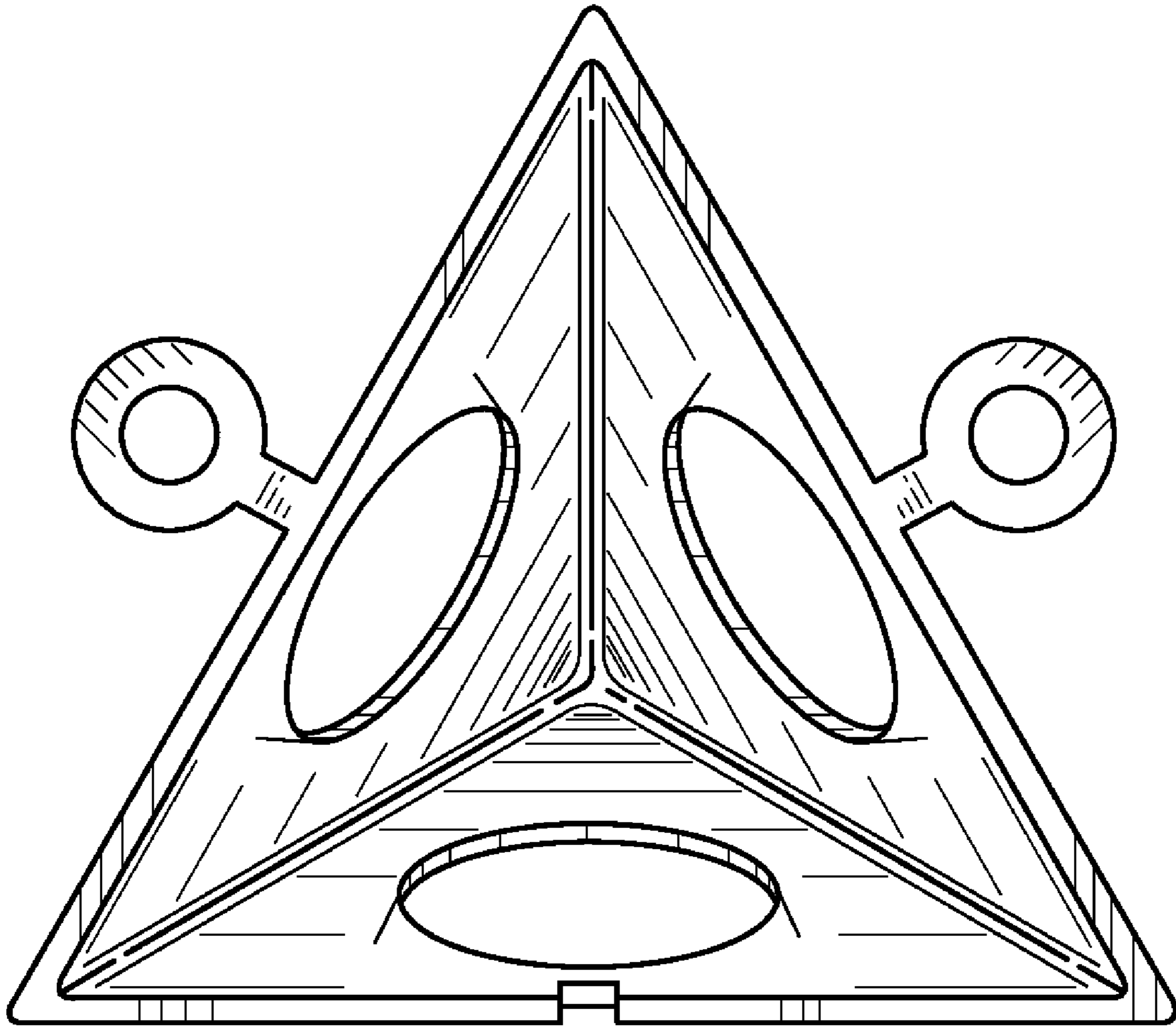

FIG. 5

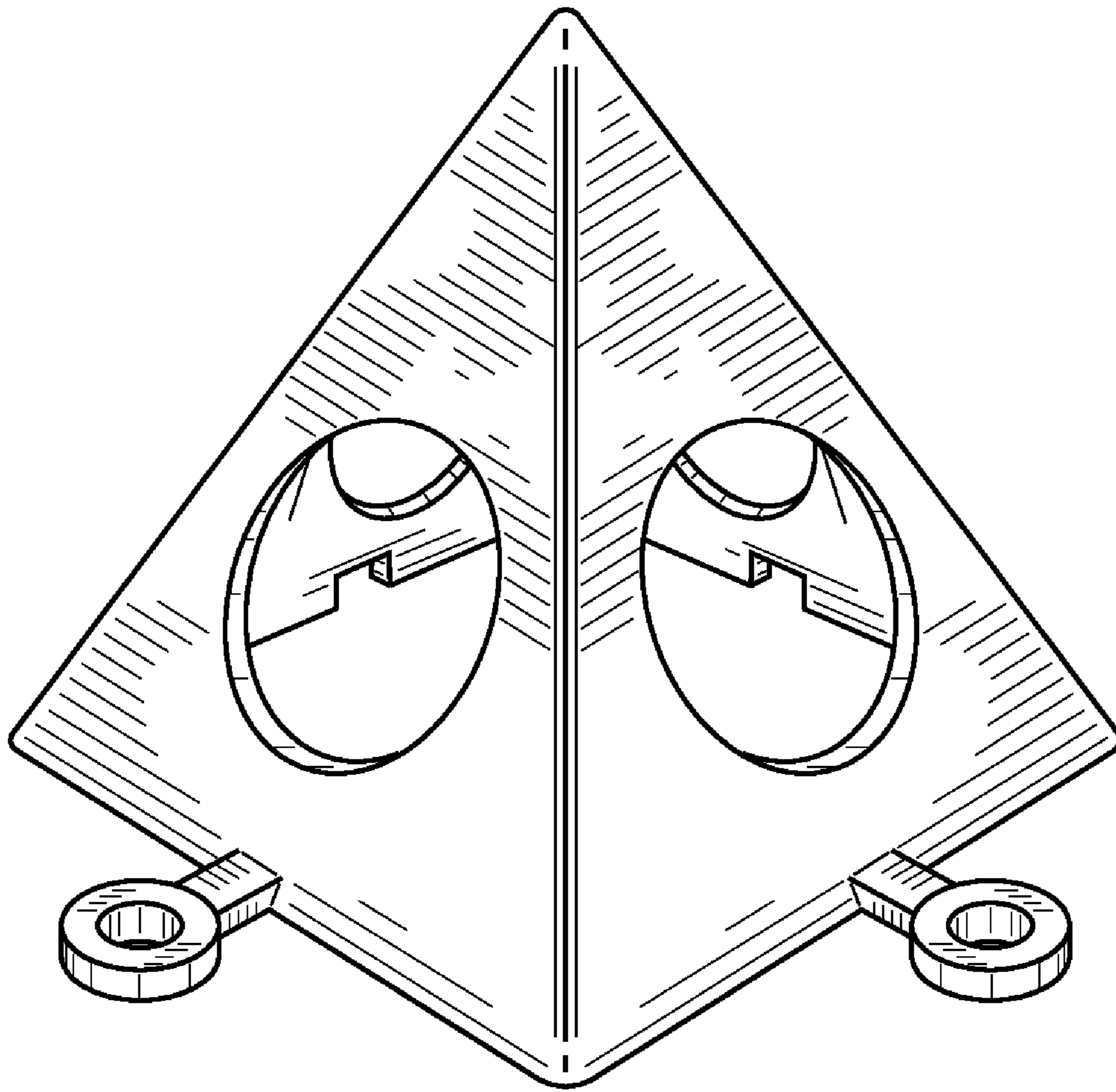

FIG. 6

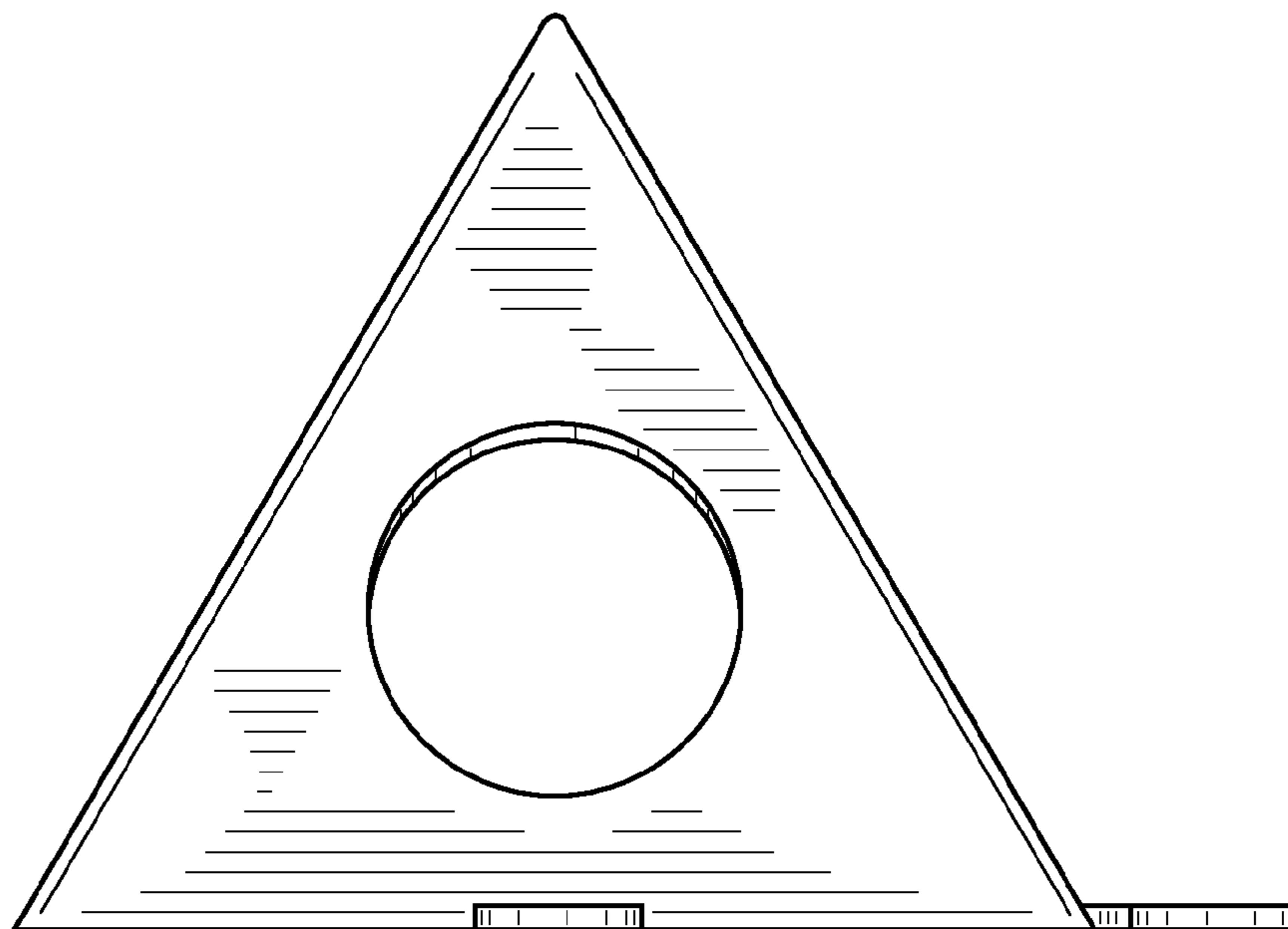

FIG. 7

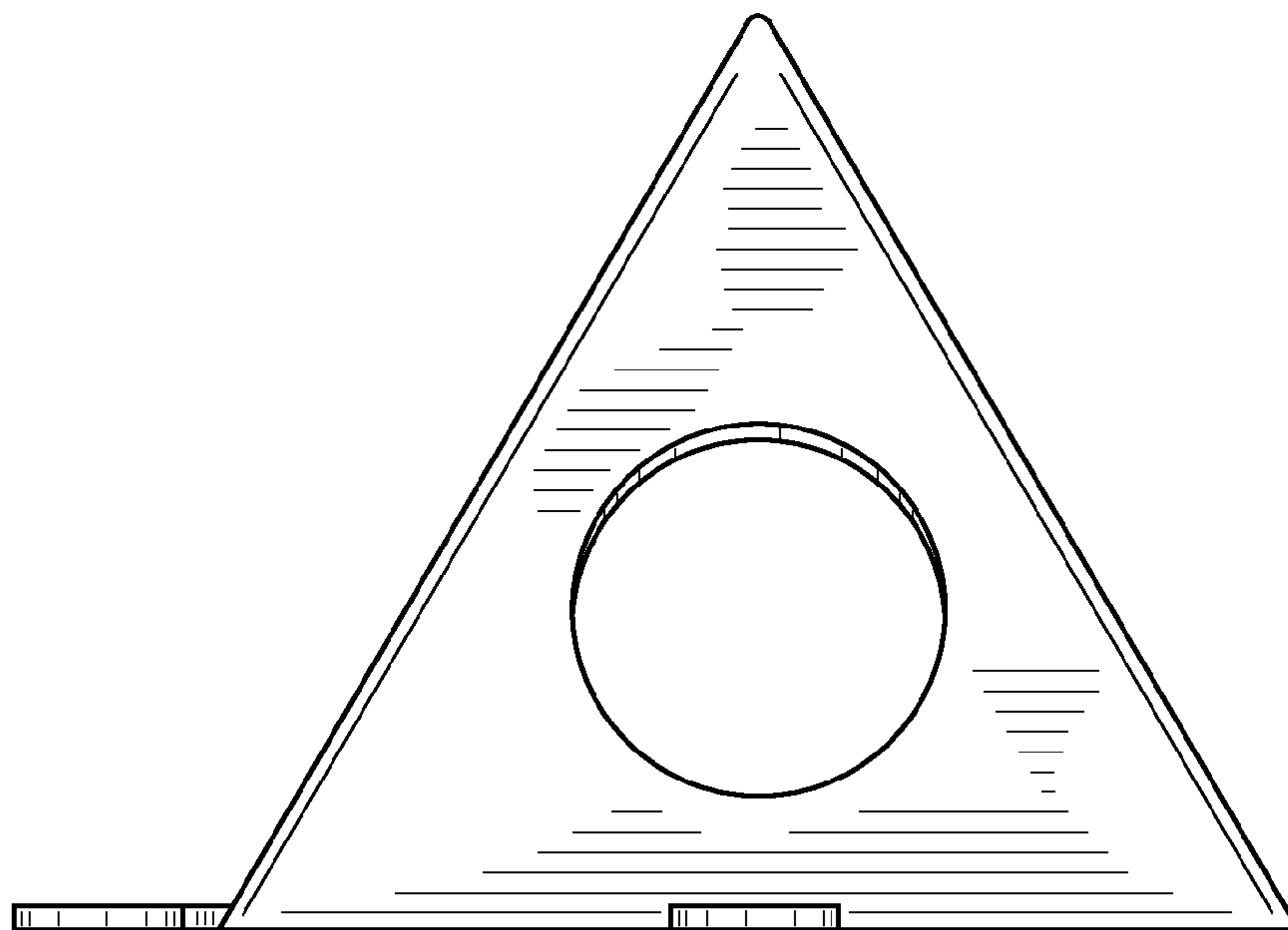

FIG. 8

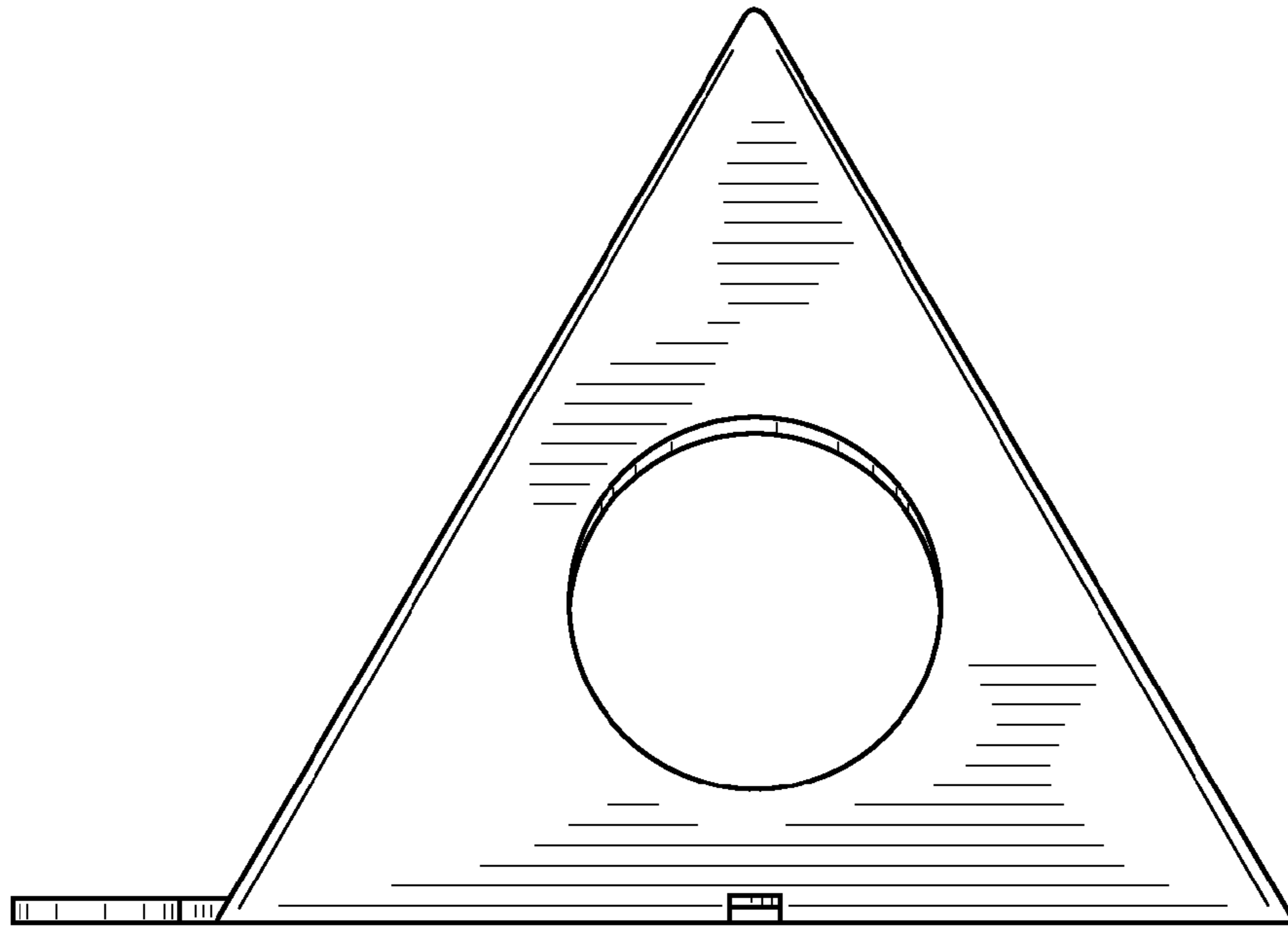

FIG. 9

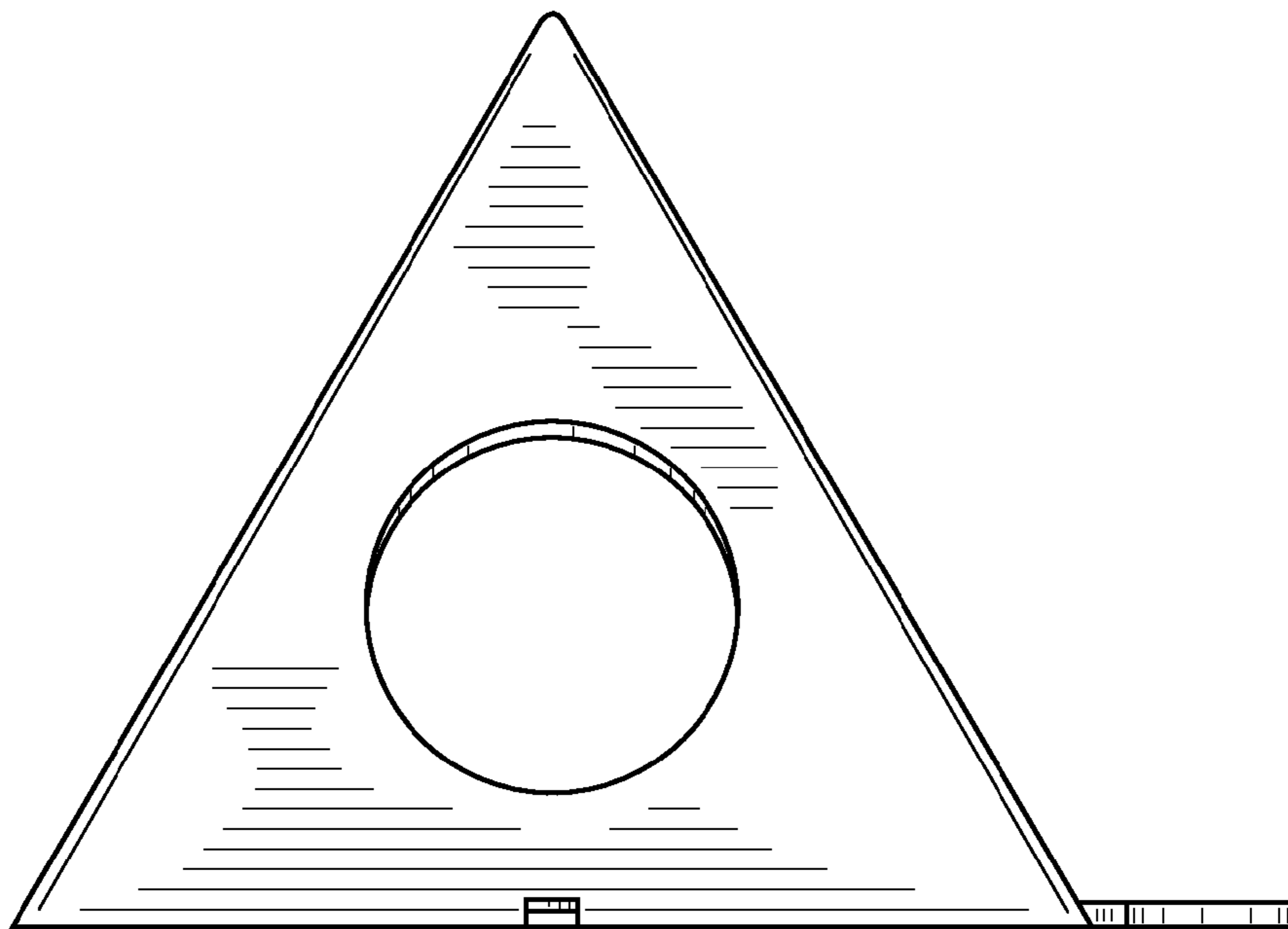

FIG. 10

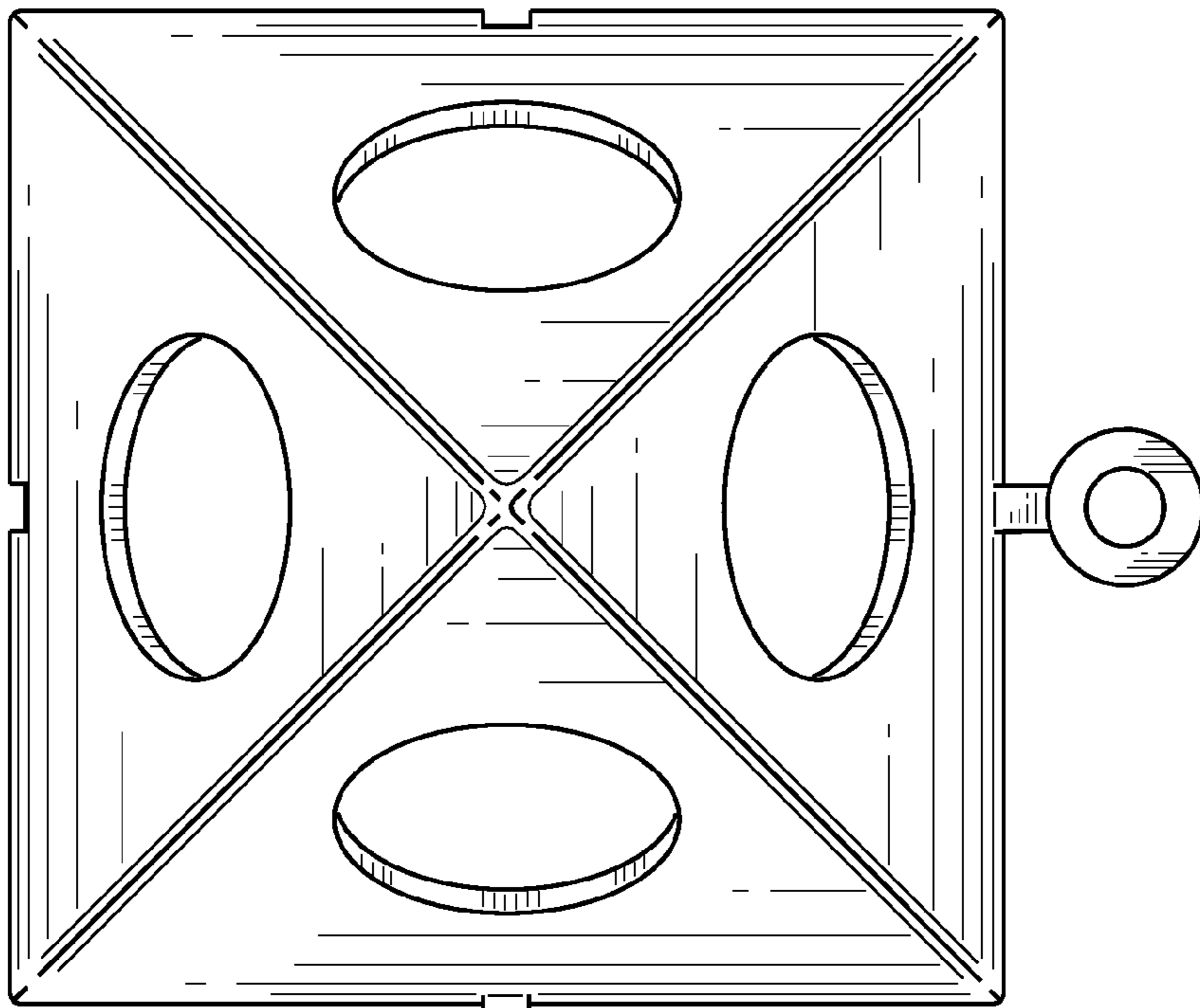

FIG. 11

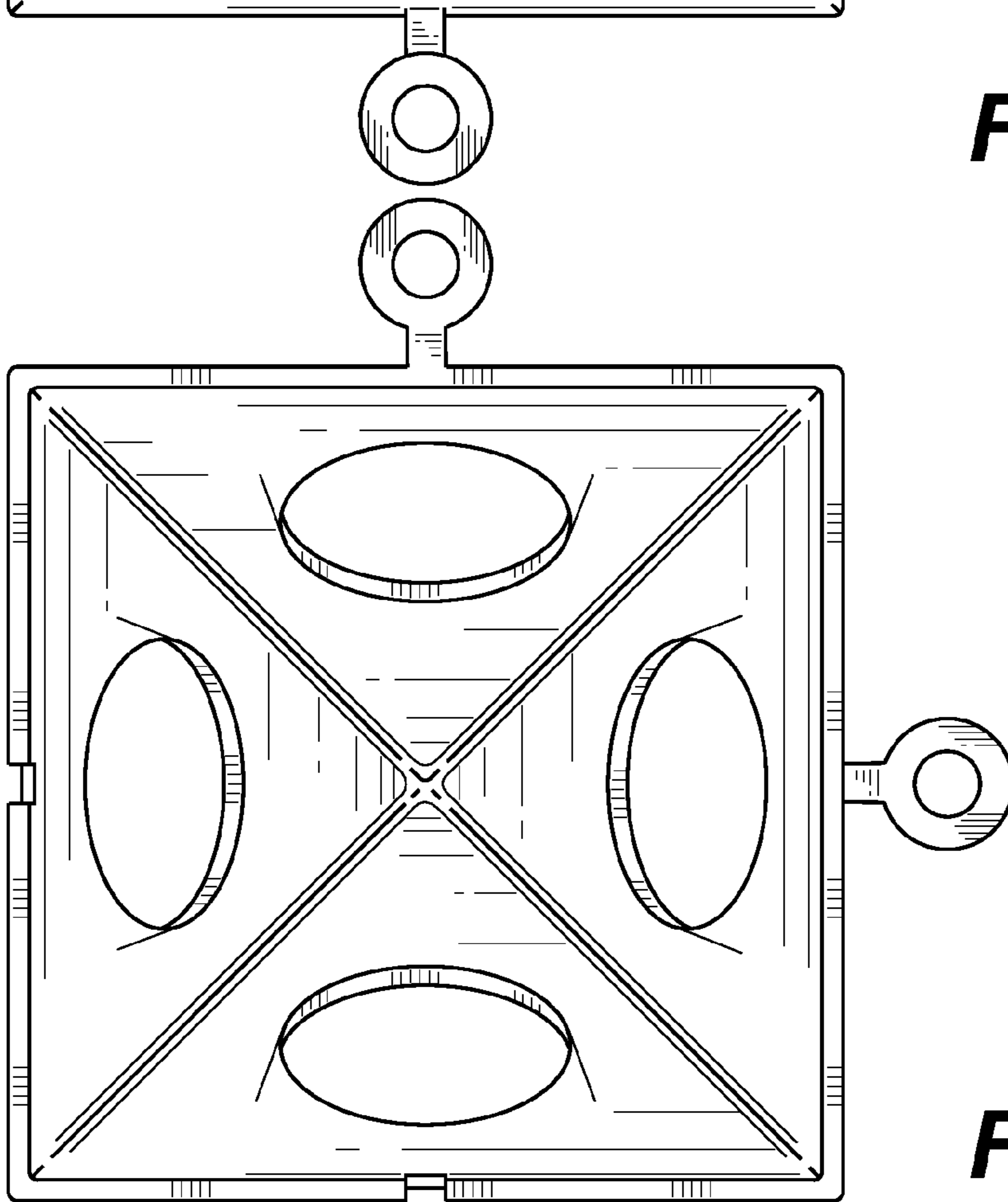

FIG. 12