



US00D631635S

(12) **United States Design Patent**
Tuli

(10) **Patent No.:** **US D631,635 S**

(45) **Date of Patent:** **** Jan. 25, 2011**

(54) **COIN BANK**

(76) **Inventor:** **Sanjeev Tuli**, 101 Moonachie Ave.,
Moonachie, NJ (US) 07074

(**) **Term:** **14 Years**

(21) **Appl. No.:** **29/348,844**

(22) **Filed:** **Feb. 16, 2010**

(51) **LOC (9) Cl.** **03-01**

(52) **U.S. Cl.** **D99/37**

(58) **Field of Classification Search** D99/28-43,
D99/99; D18/3.1, 3.3, 12.1; D20/1, 2; D14/125,
D14/129-130, 308, 387, 900; D25/7, 10,
D25/16; 109/2, 7, 9, 24.1, 28, 38-39, 45,
109/47-50, 54, 59 R, 66, 70; 235/379; 220/258.2,
220/258.5, 729; D6/397, 450, 457, 470,
D6/510; D3/272-273, 294; D7/392.1, 509-511,
D7/507, 900; D9/434-436, 447, 454
See application file for complete search history.

(56) **References Cited**

U.S. PATENT DOCUMENTS

D379,928 S * 6/1997 Freek et al. D9/447
D402,556 S * 12/1998 Frye D9/447
D416,660 S * 11/1999 Lin D23/226

D476,891 S * 7/2003 Clarke et al. D9/447
D499,961 S * 12/2004 Wilson D9/665
D505,832 S * 6/2005 Rosow D7/515

* cited by examiner

Primary Examiner—Lisa P Lichtenstein

(74) *Attorney, Agent, or Firm*—Myron Amer P.C.

(57) **CLAIM**

The ornamental design for a coin bank, as shown and described.

DESCRIPTION

FIG. 1 is a front perspective view of a coin bank;
FIG. 2 is a front elevational view thereof;
FIG. 3 is a right side elevational view thereof, of which the left side elevational view is a mirror image thereof;
FIG. 4 is a rear elevational view thereof;
FIG. 5 is a top plan view thereof; and,
FIG. 6 is a bottom plan view thereof.

The broken line showing of portions of a plastic cover of the coin bank is included for the purpose of illustrating environmental structure and forms no part of the claimed design.

1 Claim, 5 Drawing Sheets

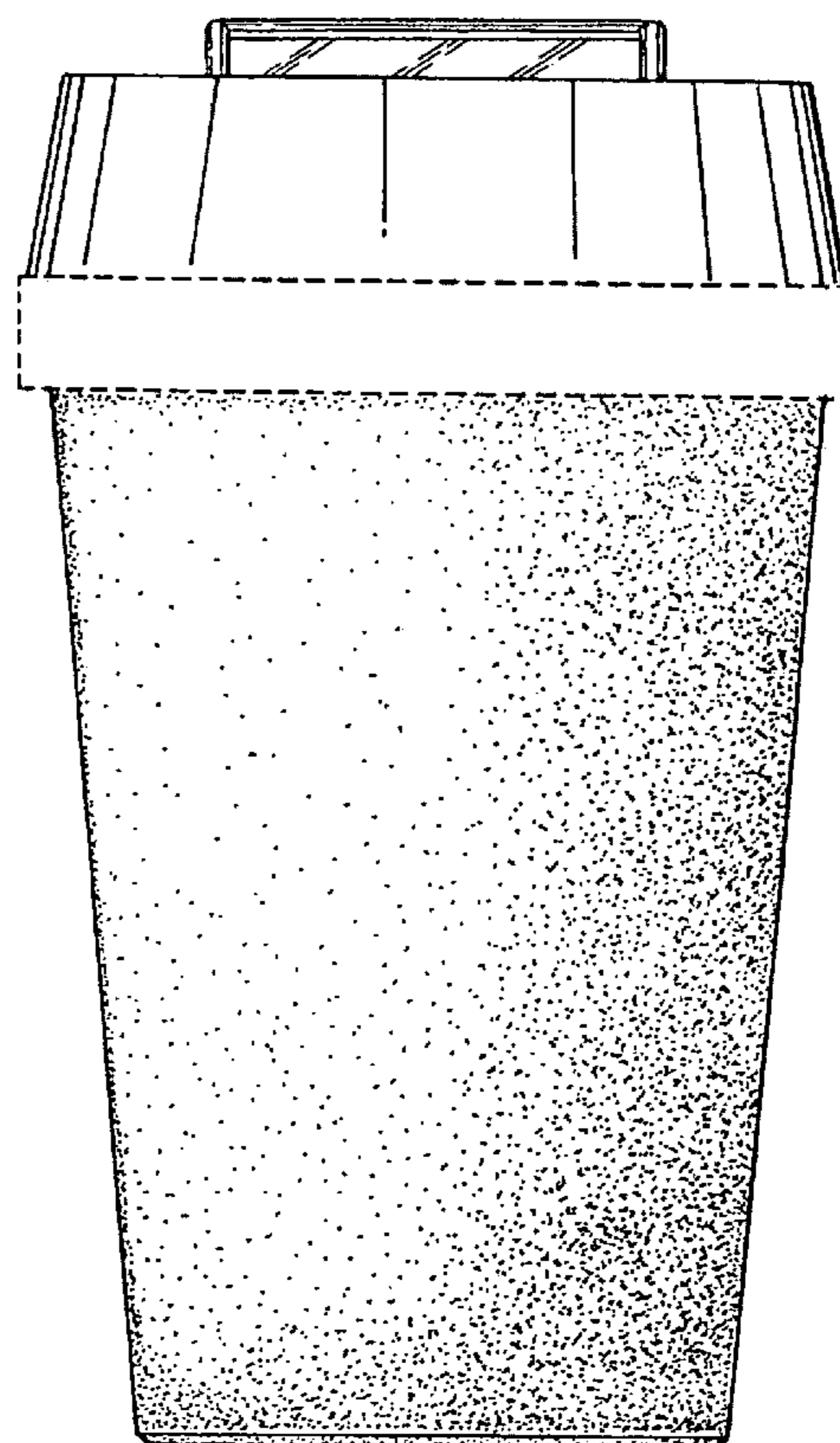
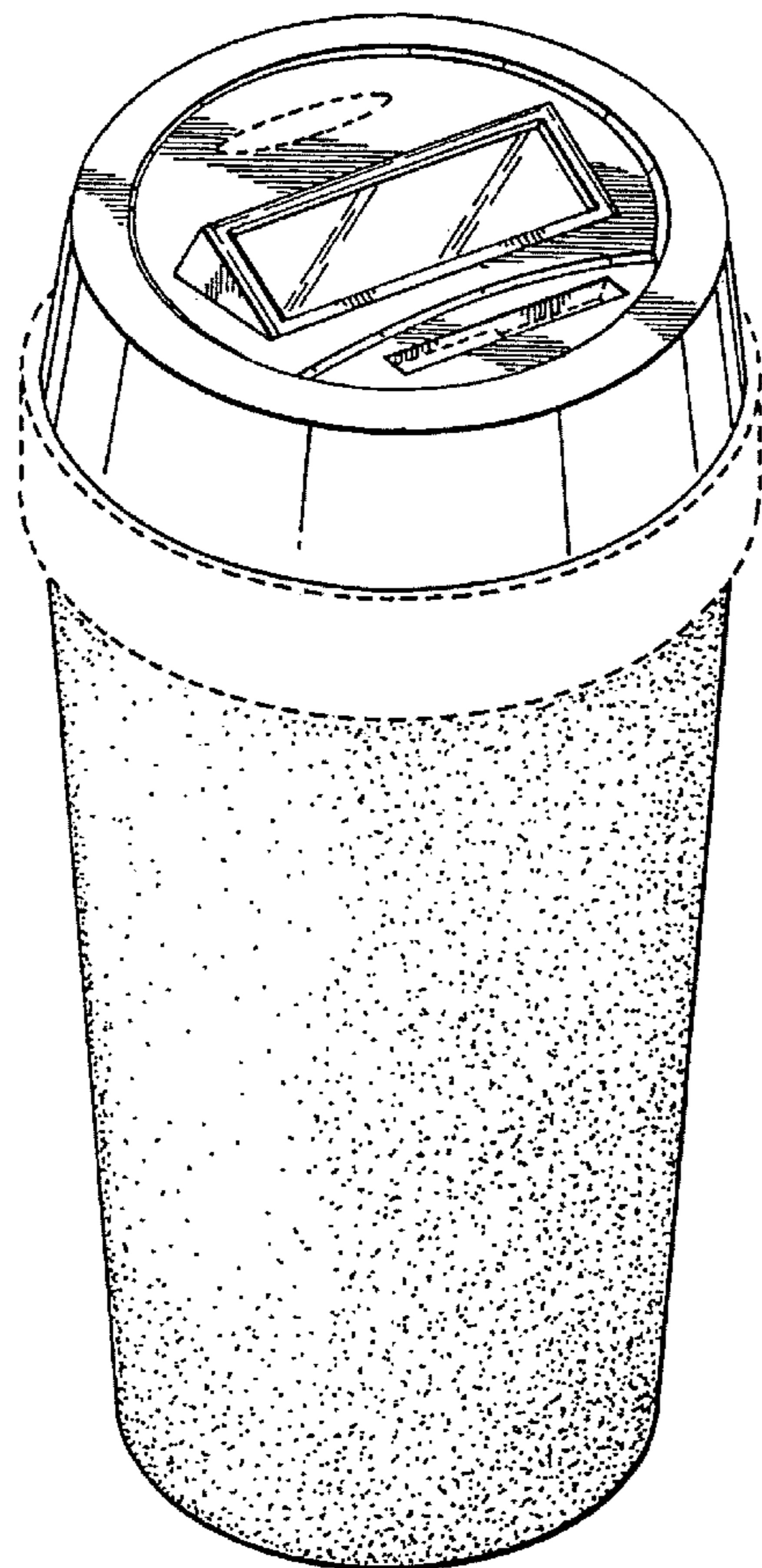

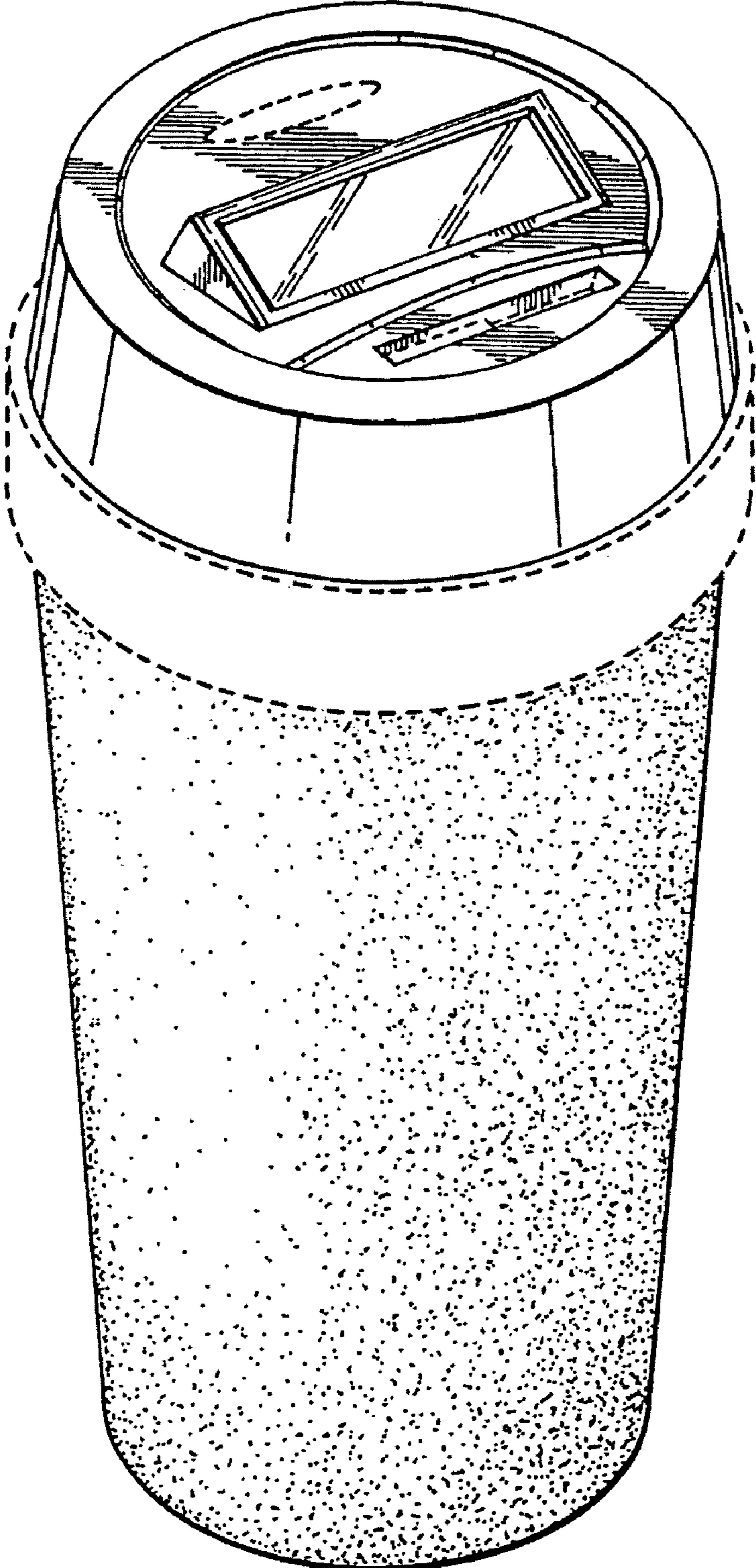

Fig. 1

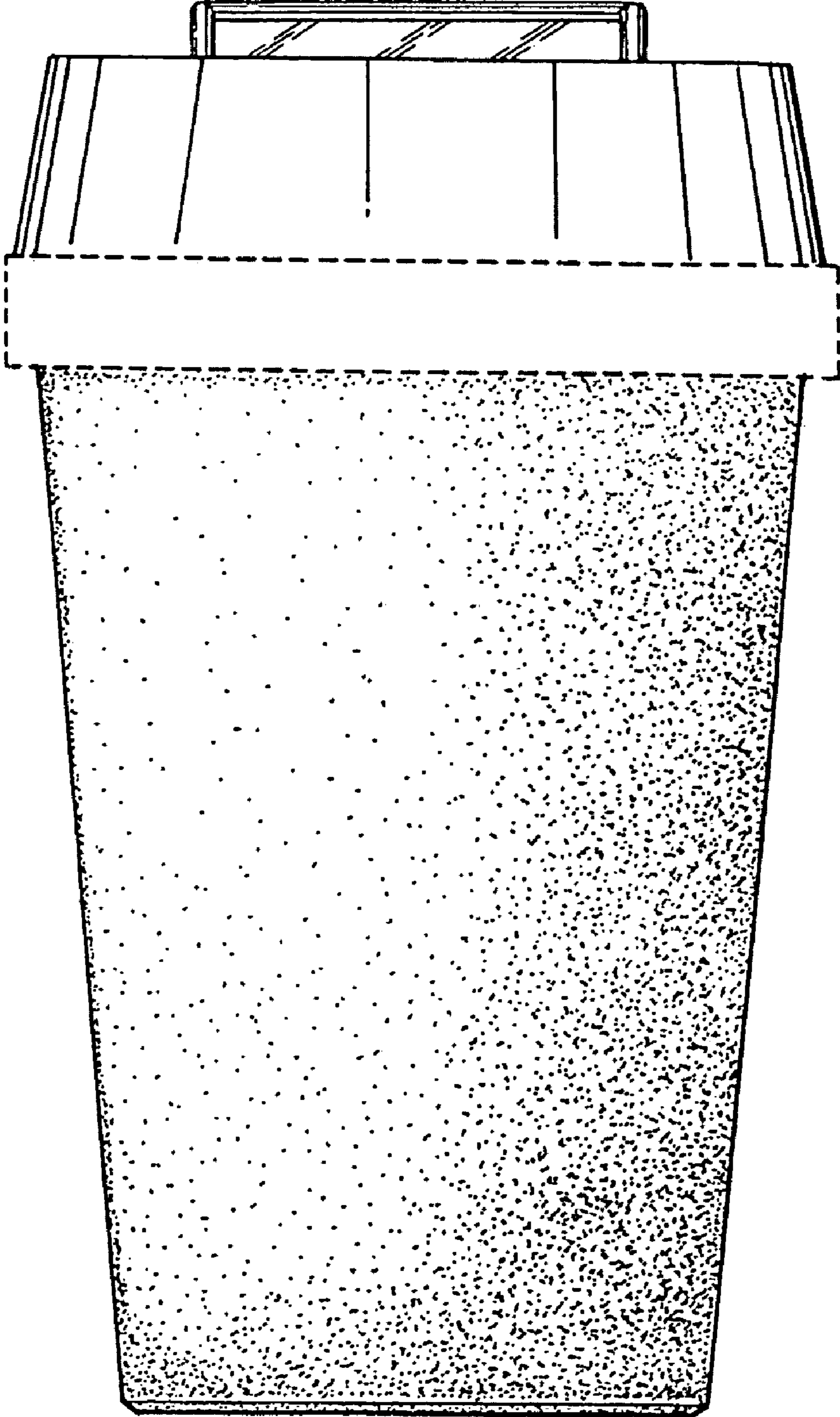

Fig. 2

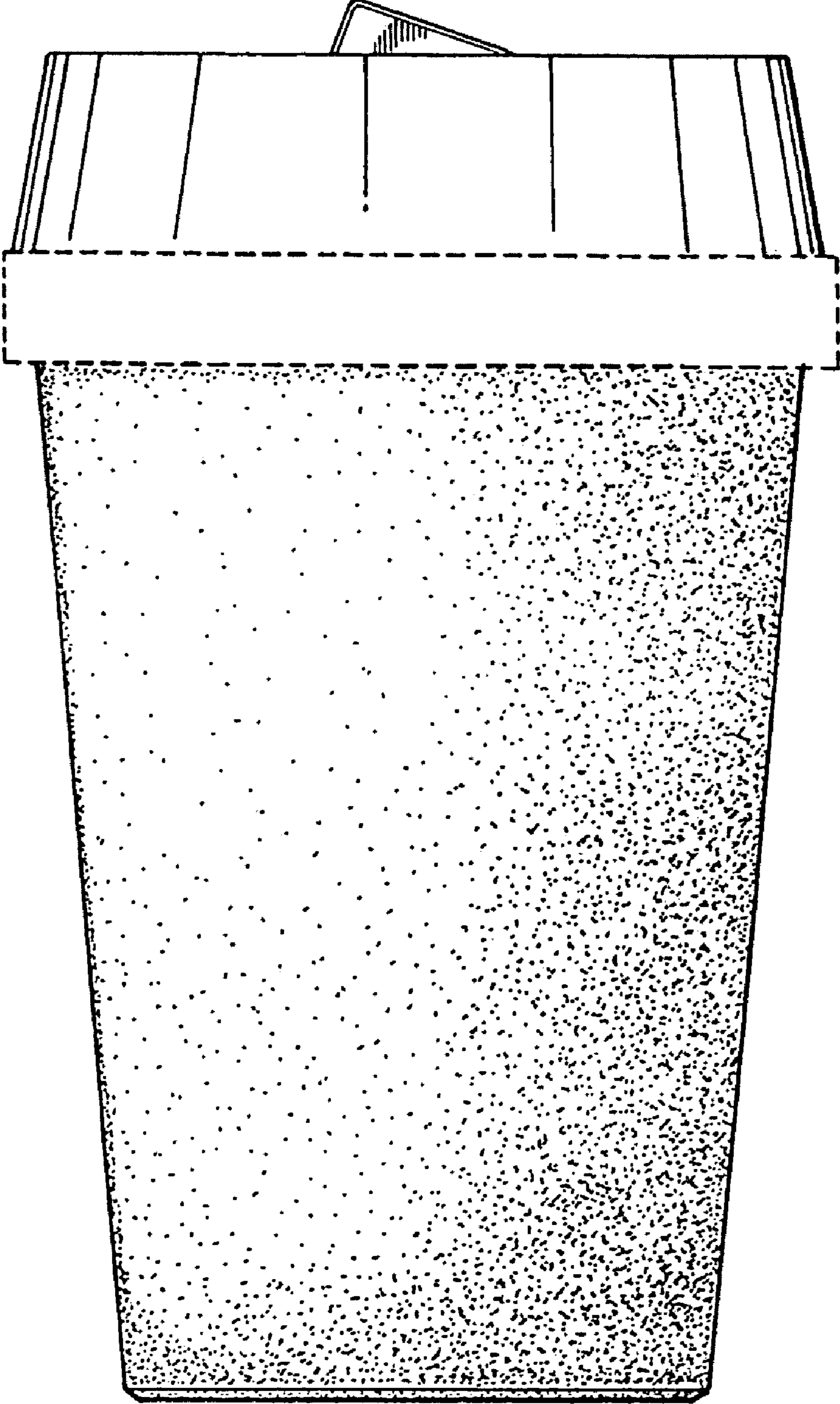

Fig. 3

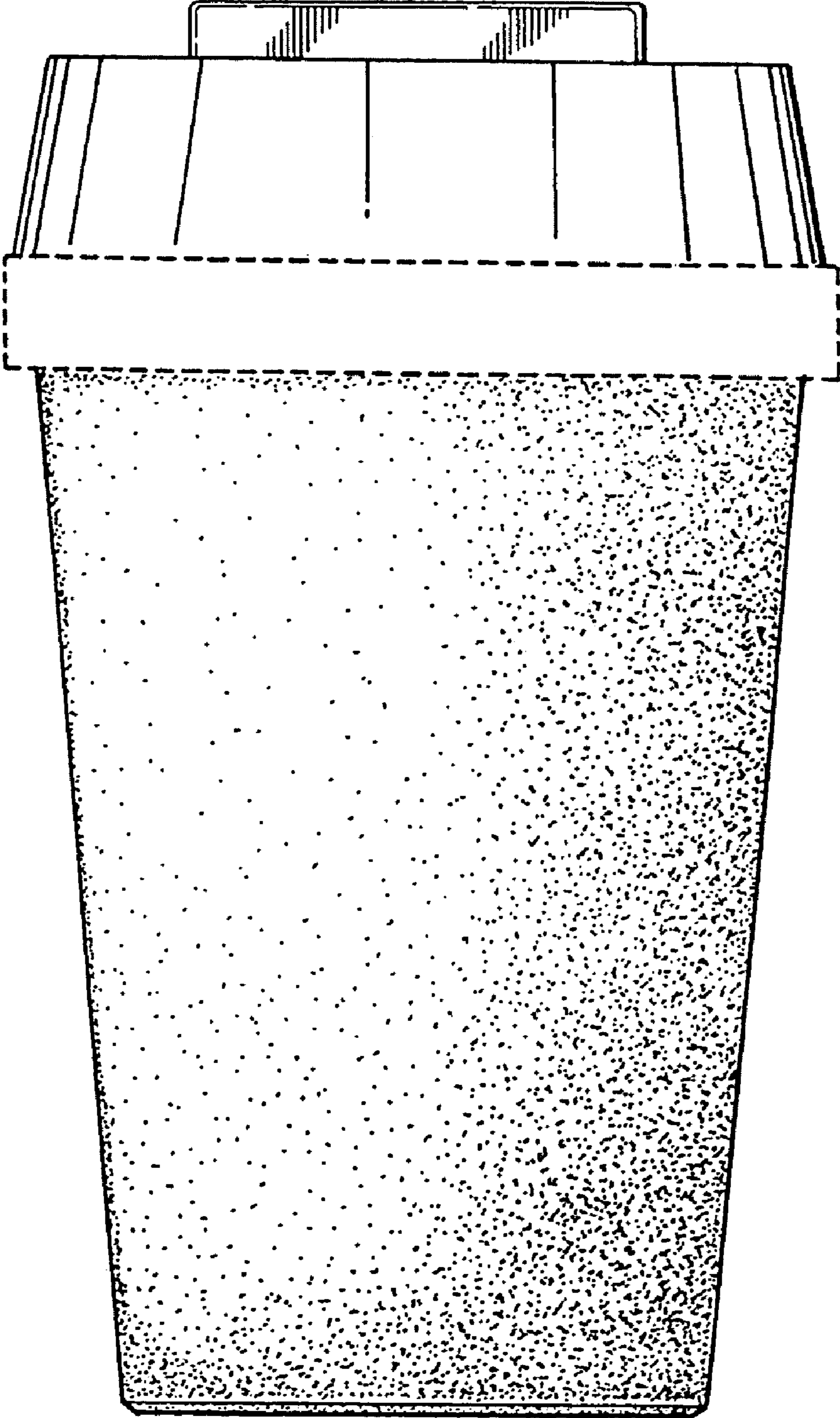

Fig. 4

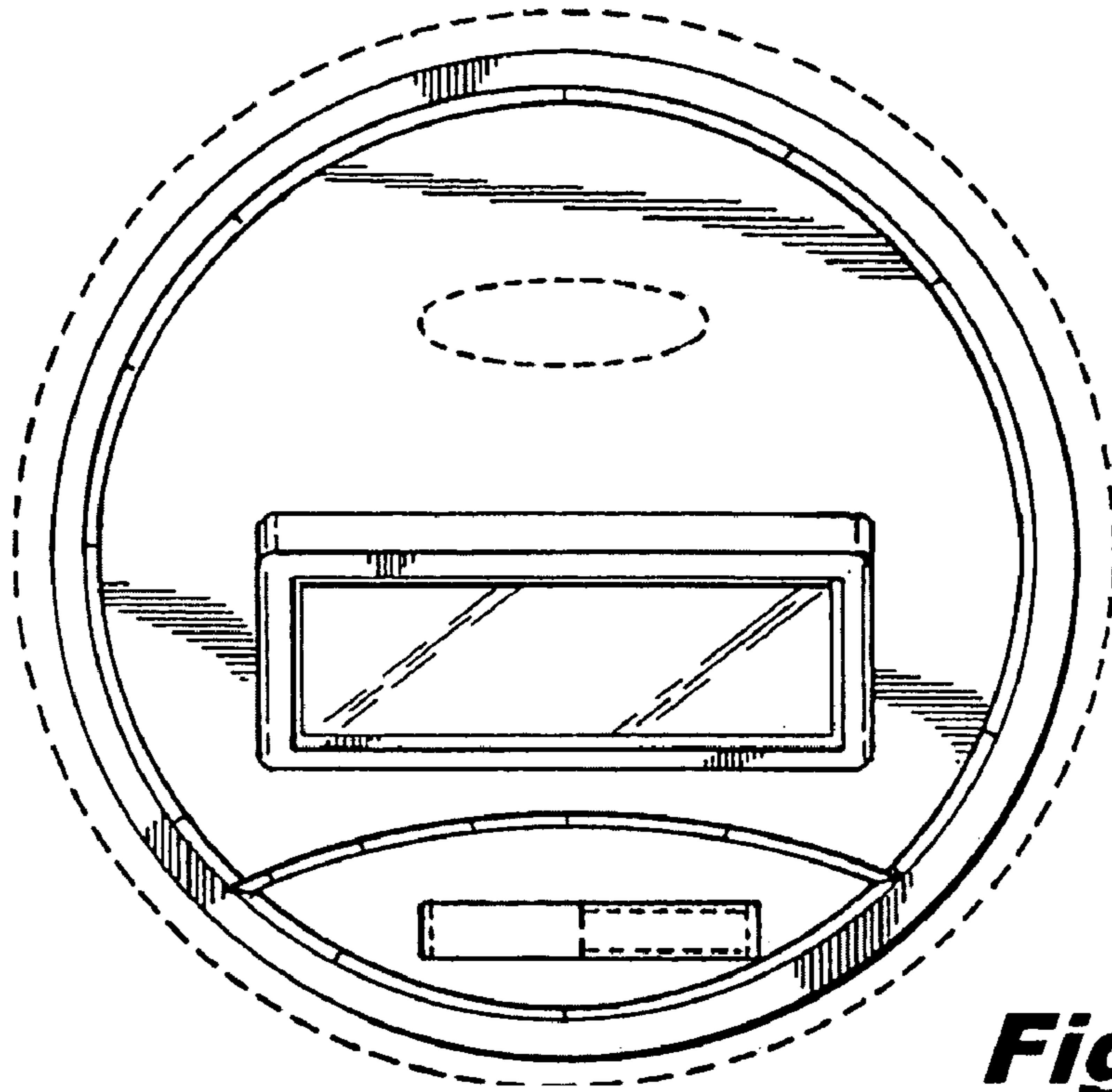

Fig. 5

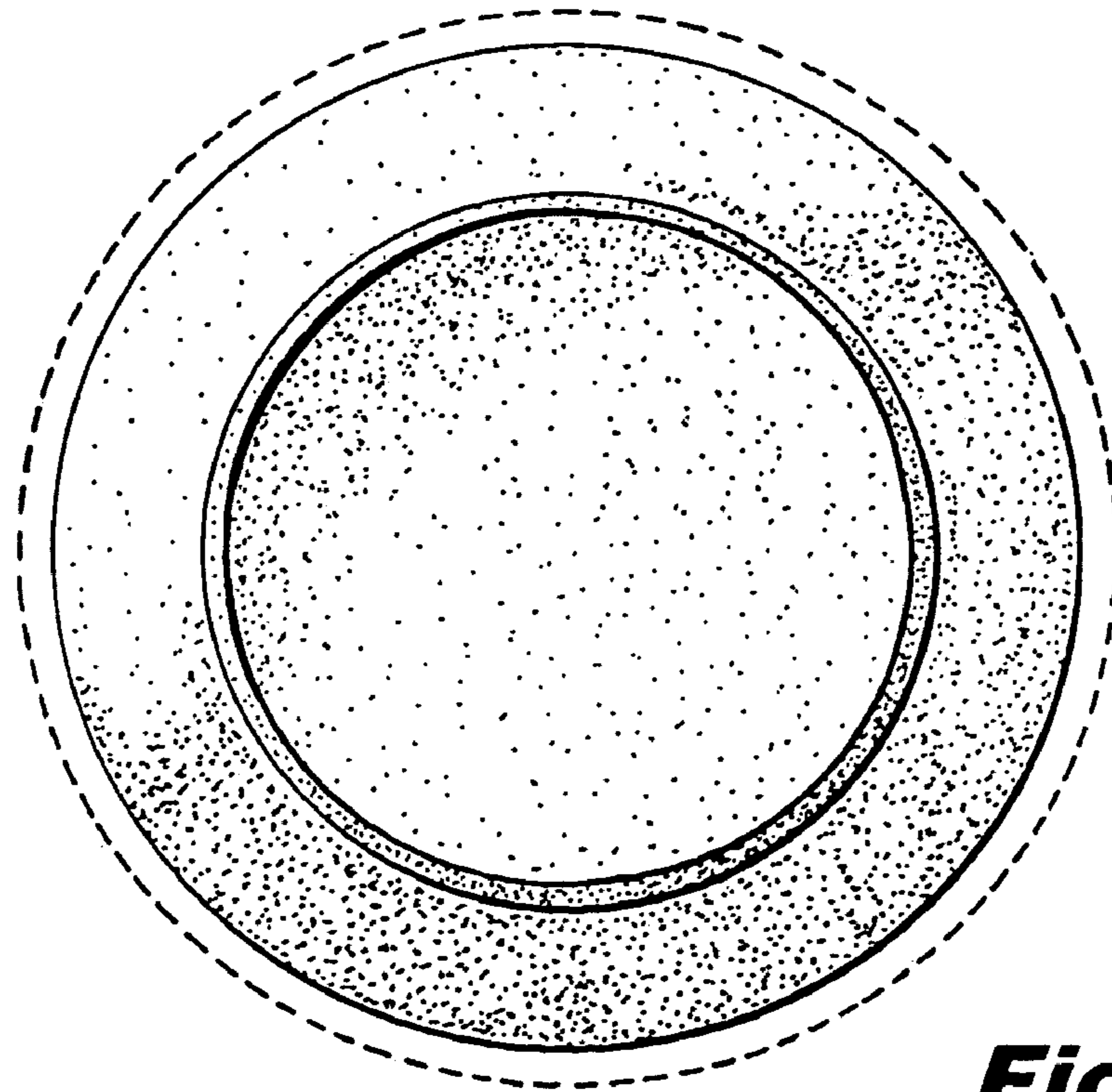

Fig. 6