



US00D631611S

(12) **United States Design Patent**  
**Sattler**

(10) **Patent No.:** **US D631,611 S**

(45) **Date of Patent:** **\*\* Jan. 25, 2011**

(54) **TACTICAL CHEST RIG**

D600,860 S \* 9/2009 Durham ..... D29/101.3  
D602,205 S \* 10/2009 Thomas et al. .... D29/101.4

(76) **Inventor:** **Stuart S. Sattler**, 23009 W. Sprague Rd., Reardan, WA (US) 99029

\* cited by examiner

(\*\*) **Term:** **14 Years**

*Primary Examiner*—Robert M Spear

*Assistant Examiner*—Barbara B Lohr

(21) **Appl. No.:** **29/348,418**

(74) *Attorney, Agent, or Firm*—R. Tracy Crump

(22) **Filed:** **Dec. 31, 2009**

(57) **CLAIM**

(51) **LOC (9) Cl.** ..... **09-03**

The ornamental design for a tactical chest rig, as shown and described.

(52) **U.S. Cl.** ..... **D29/101.4**

(58) **Field of Classification Search** ..... D29/11,  
D29/99, 100, 101.2, 101.3, 101.4; 362/108;  
441/80

**DESCRIPTION**

See application file for complete search history.

FIG. 1 is a perspective view of a tactical chest rig showing my new design;

FIG. 2 is a front view thereof;

FIG. 3 is a rear view thereof;

FIG. 4 is a right side view thereof;

FIG. 5 is a left side view thereof; and,

FIG. 6 is a top view thereof;

(56) **References Cited**

**U.S. PATENT DOCUMENTS**

D340,543 S \* 10/1993 Ashton ..... D29/101.4  
D484,648 S \* 12/2003 Fiorini et al. .... D29/101.3  
6,991,343 B2 \* 1/2006 Langley et al. .... 362/108  
7,261,608 B2 \* 8/2007 Haddacks ..... 441/80

**1 Claim, 6 Drawing Sheets**

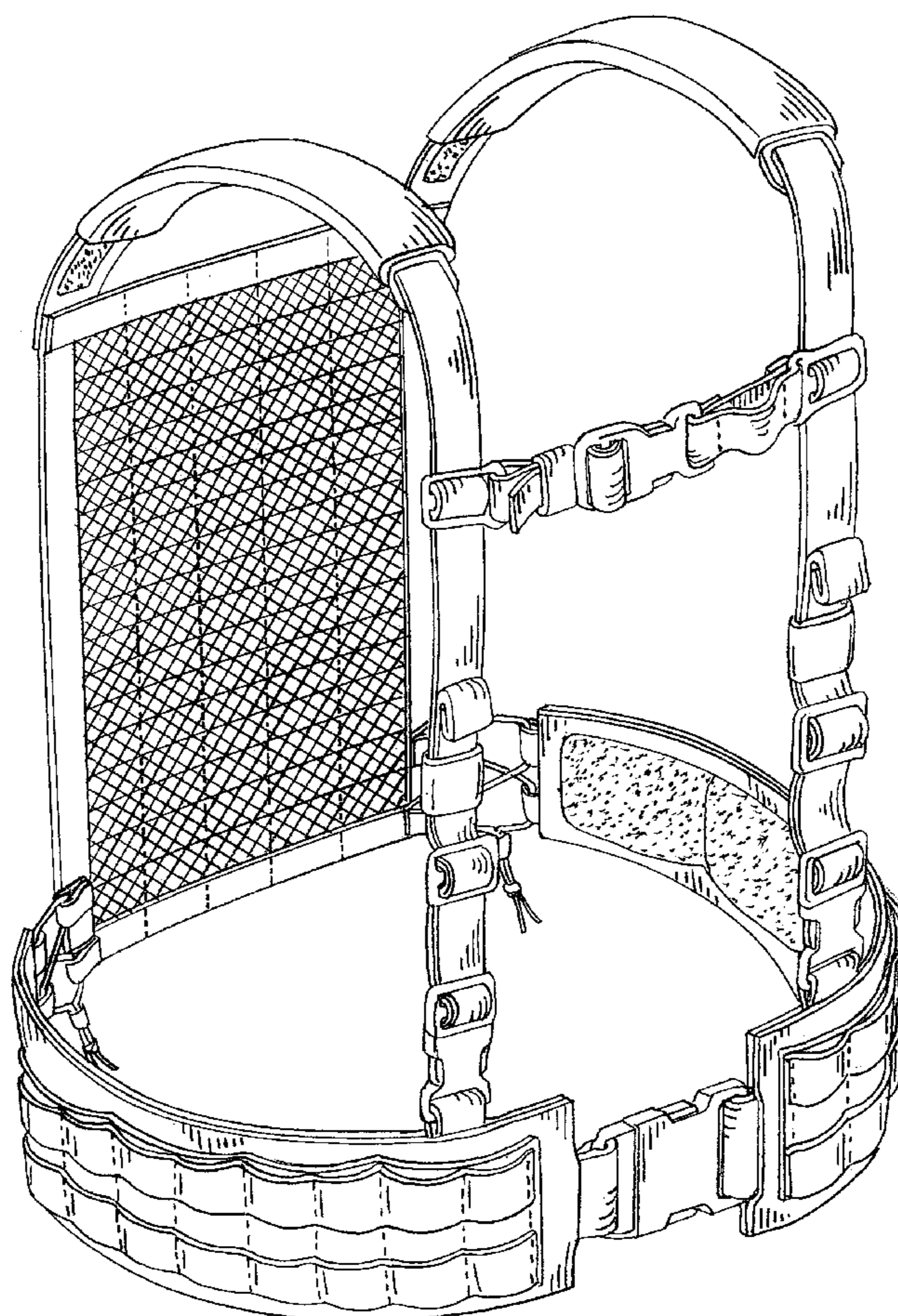

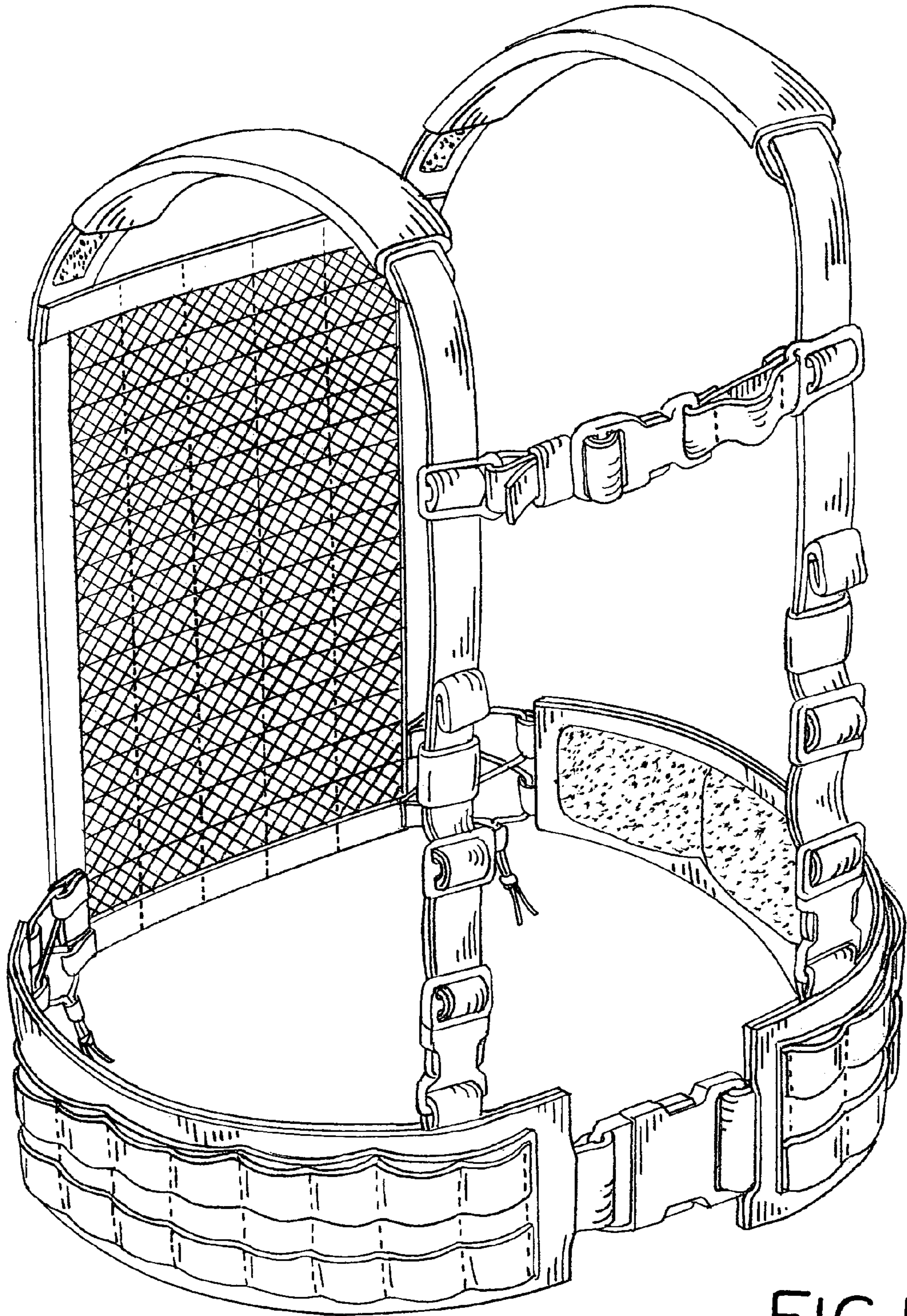

FIG. 1

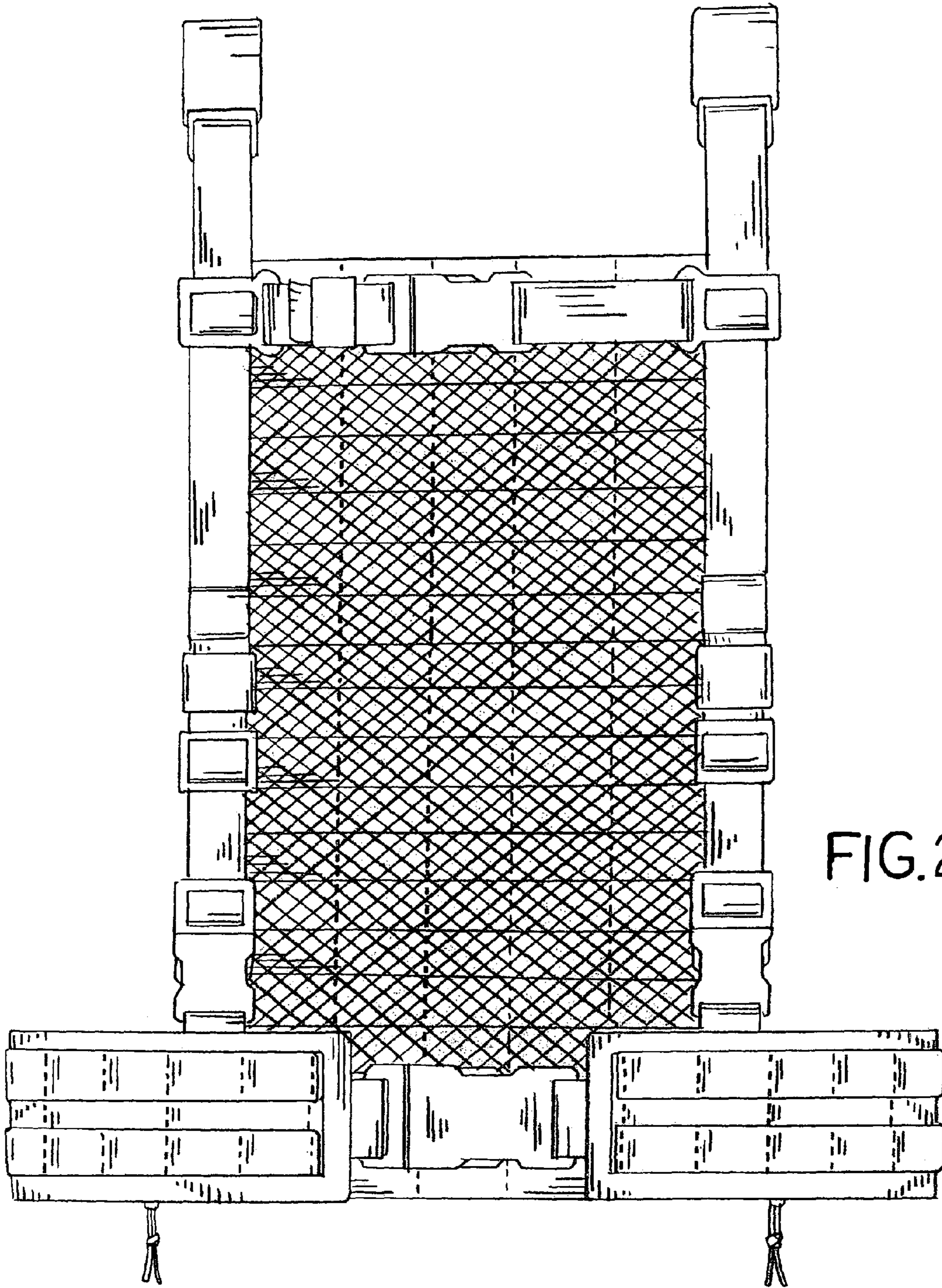
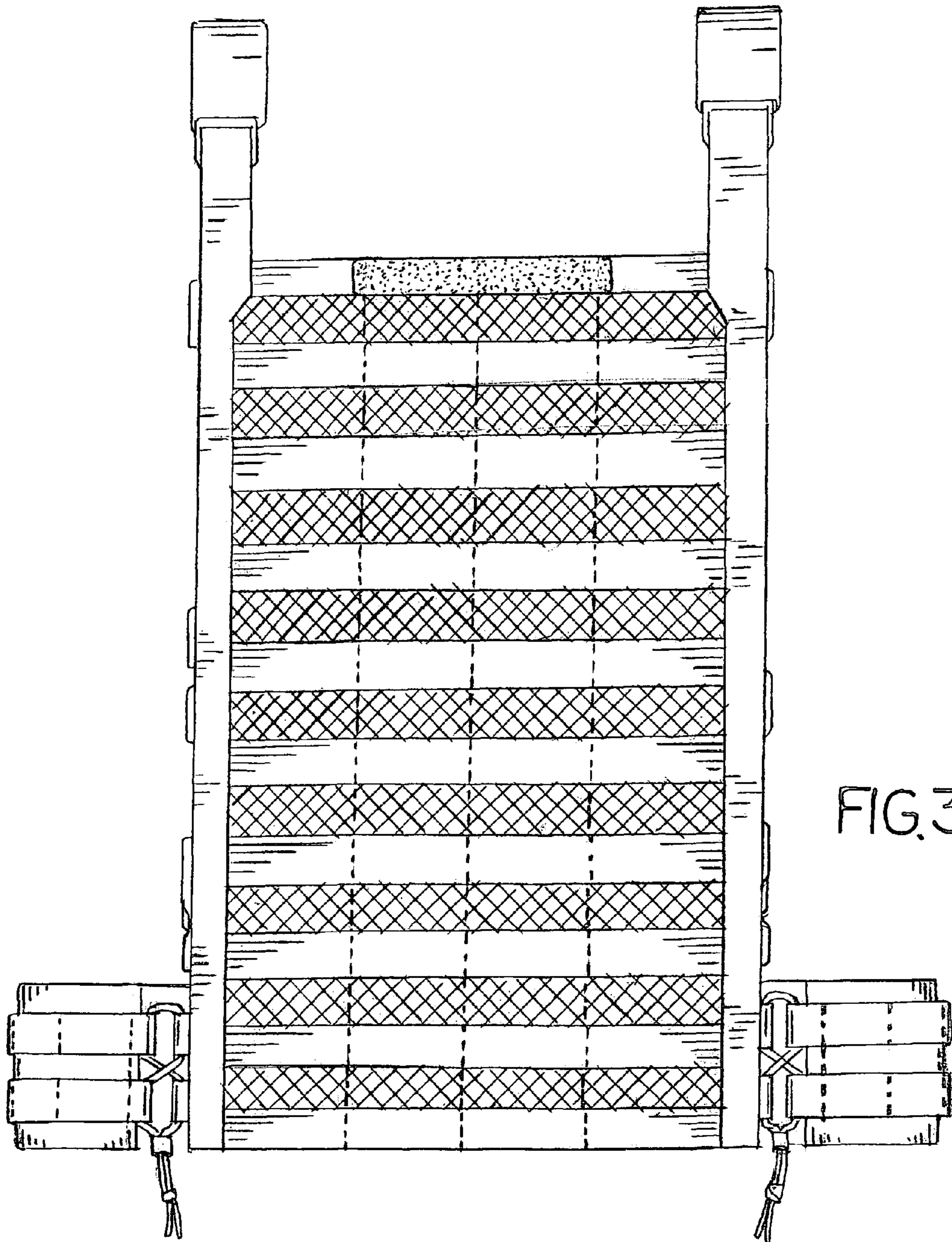

FIG.2



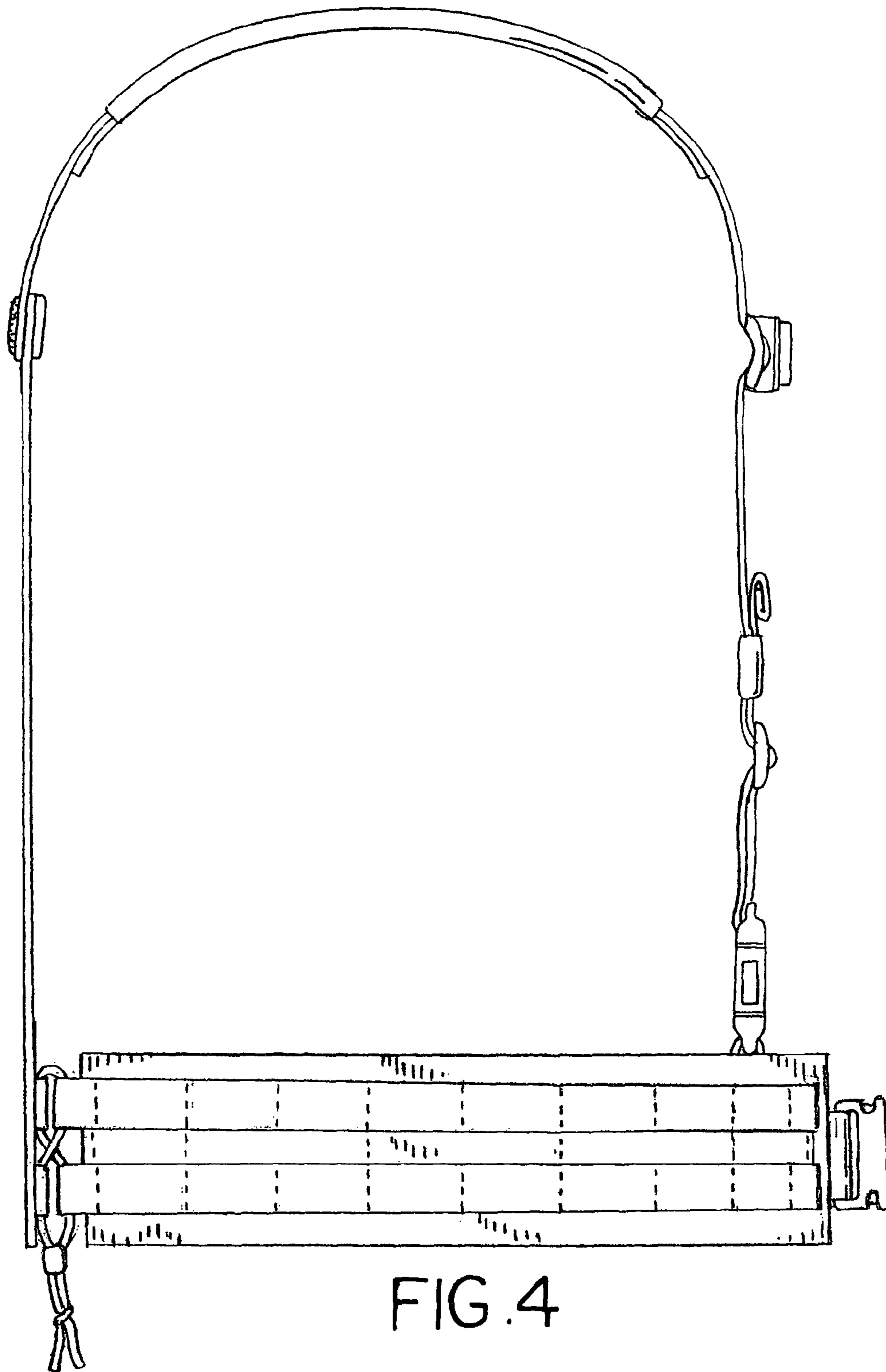

FIG. 4

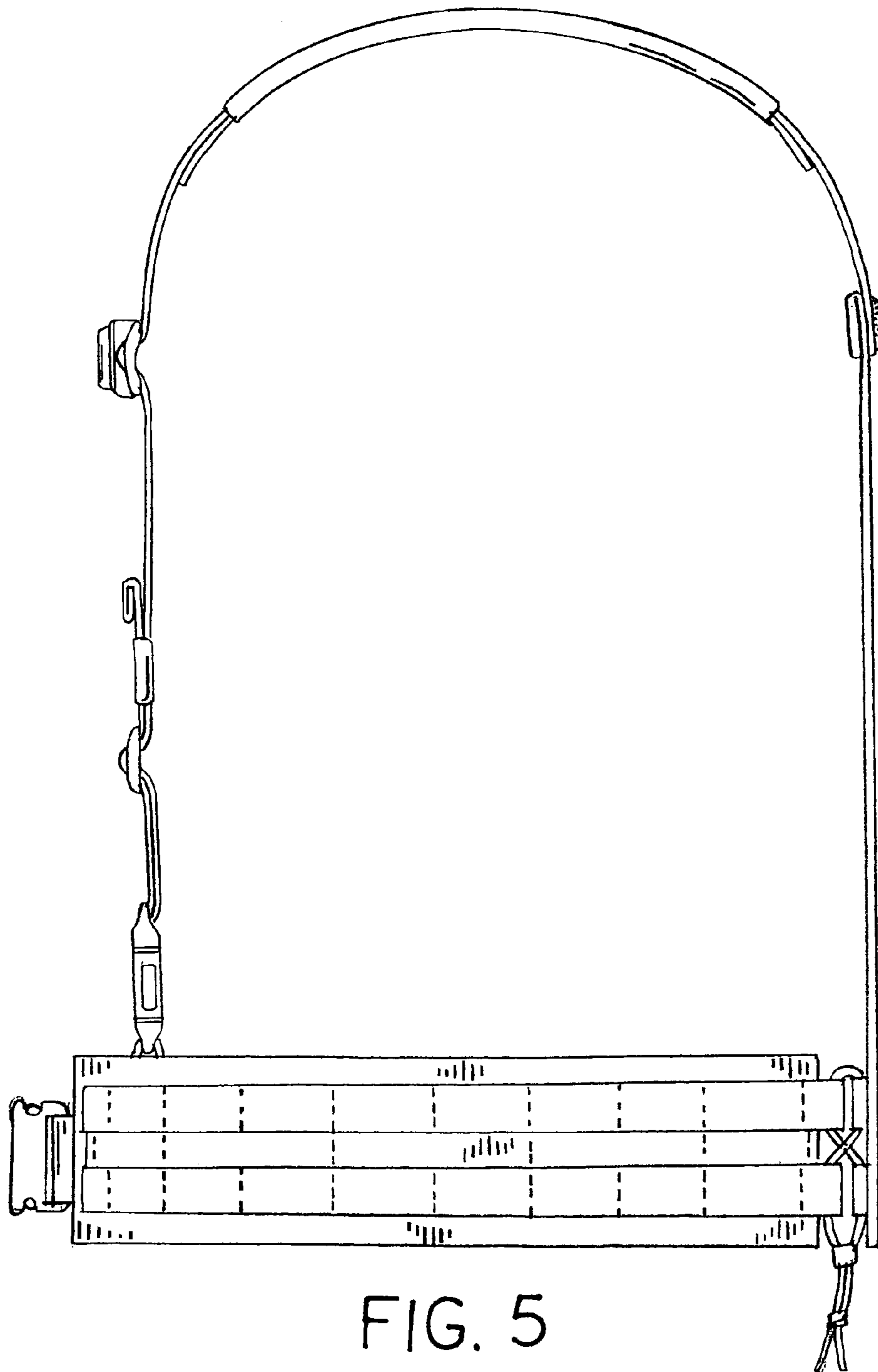

FIG. 5

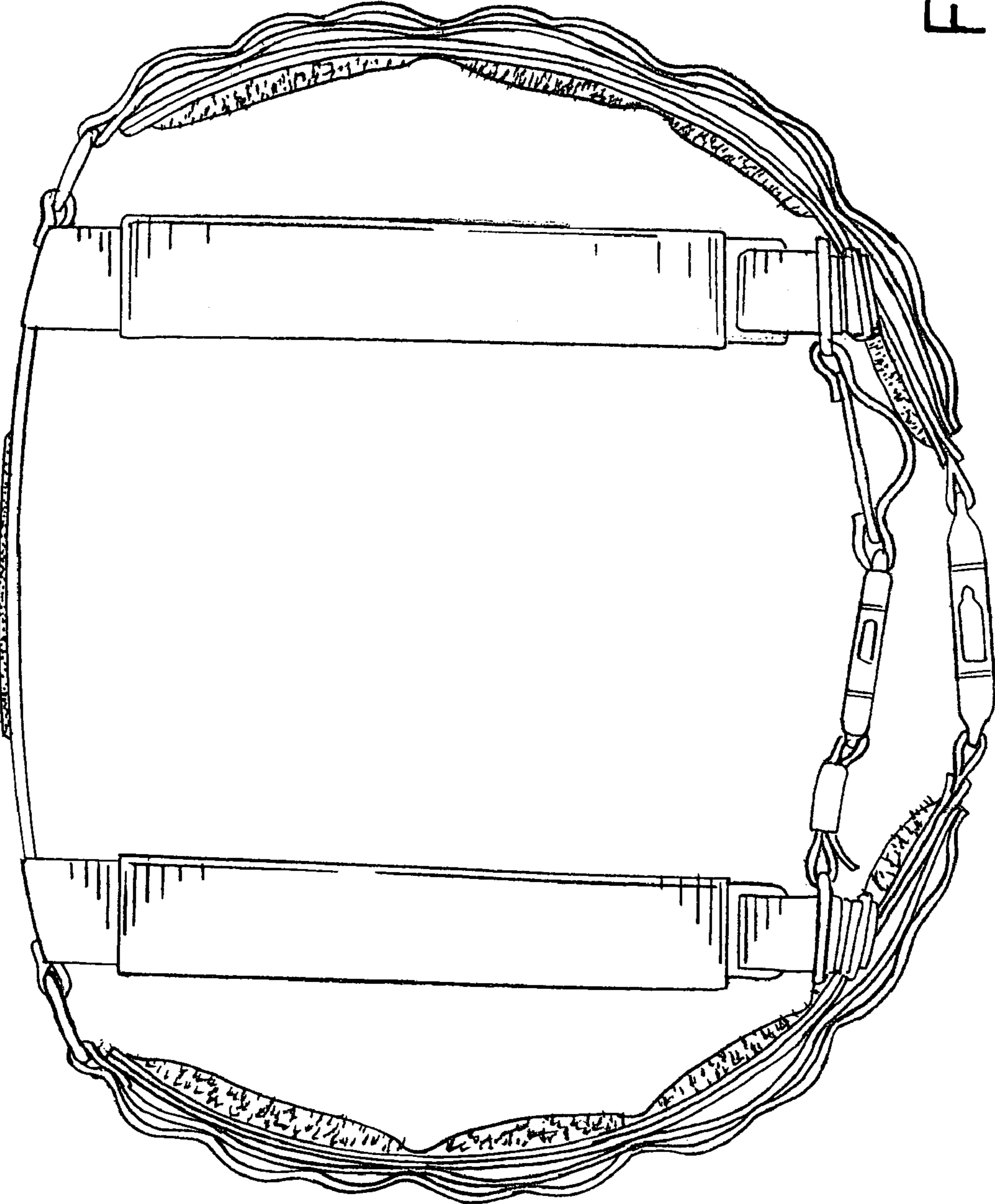

FIG. 6