



US00D631592S

(12) **United States Design Patent**  
**Rosas**

(10) **Patent No.:** **US D631,592 S**  
(45) **Date of Patent:** **\*\* Jan. 25, 2011**

(54) **LIGHTING FIXTURE**

(75) Inventor: **Apolinar Rosas**, La Habra, CA (US)

(73) Assignee: **American Induction Technologies, Inc.**, Anaheim, CA (US)

(\*\*) Term: **14 Years**

(21) Appl. No.: **29/364,978**

(22) Filed: **Jun. 30, 2010**

(51) **LOC (9) Cl.** ..... **26-05**

(52) **U.S. Cl.** ..... **D26/71**

(58) **Field of Classification Search** ..... D26/67-71,  
D26/85, 92; 362/145, 183, 231, 240, 249.02,  
362/249.03, 249.04, 249.06, 249.16, 431  
See application file for complete search history.

(56) **References Cited**

**U.S. PATENT DOCUMENTS**

D192,041 S *	1/1962	Izzi .....	D26/71
D199,327 S *	10/1964	Guth, Jr. ....	D26/72
D348,945 S *	7/1994	Mehaffey et al. ....	D26/71
D439,695 S *	3/2001	Compton et al. ....	D26/87
D447,590 S *	9/2001	Raouf et al. ....	D26/71
D456,552 S *	4/2002	Russello et al. ....	D26/85
D500,569 S *	1/2005	Butler .....	D26/71
D572,857 S *	7/2008	Kauffman et al. ....	D26/71
D578,697 S *	10/2008	Zheng et al. ....	D26/71
D603,077 S *	10/2009	Kinnune et al. ....	D26/71

D609,383 S *	2/2010	Chang .....	D26/71
D612,090 S *	3/2010	Yu .....	D26/92
D615,690 S *	5/2010	Zheng et al. ....	D26/71

**OTHER PUBLICATIONS**

Building Mounted Light in center of p. 469; and Pole Mounted Light in top left of p. 469 of the Lithonia Lighting Catalog @2006. (2 pages).\*

\* cited by examiner

*Primary Examiner*—Clare E Heflin

(74) *Attorney, Agent, or Firm*—Christie, Parker & Hale, LLP

(57) **CLAIM**

The ornamental design for lighting fixture, as shown and described.

**DESCRIPTION**

FIG. 1 is a perspective view thereof;

FIG. 2 is a top plan view thereof;

FIG. 3 is a left side view thereof, the right side view thereof being a mirror image of the left side view;

FIG. 4 is a bottom plan view thereof;

FIG. 5 is a front view thereof; and,

FIG. 6 is a rear view thereof.

The broken lines shown on the drawings depict portions of the <light fixture> that form no part of the claimed design.

**1 Claim, 6 Drawing Sheets**

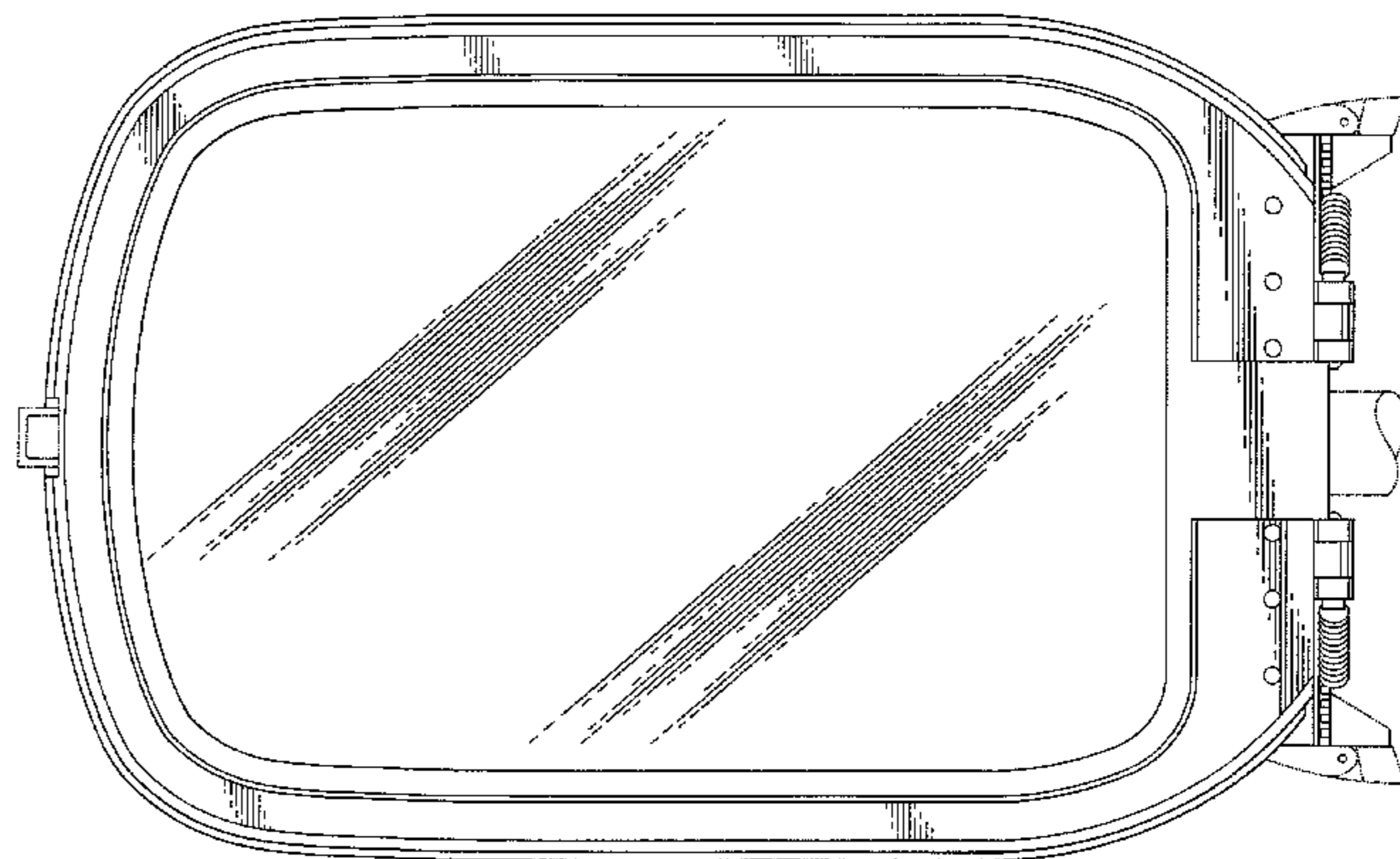
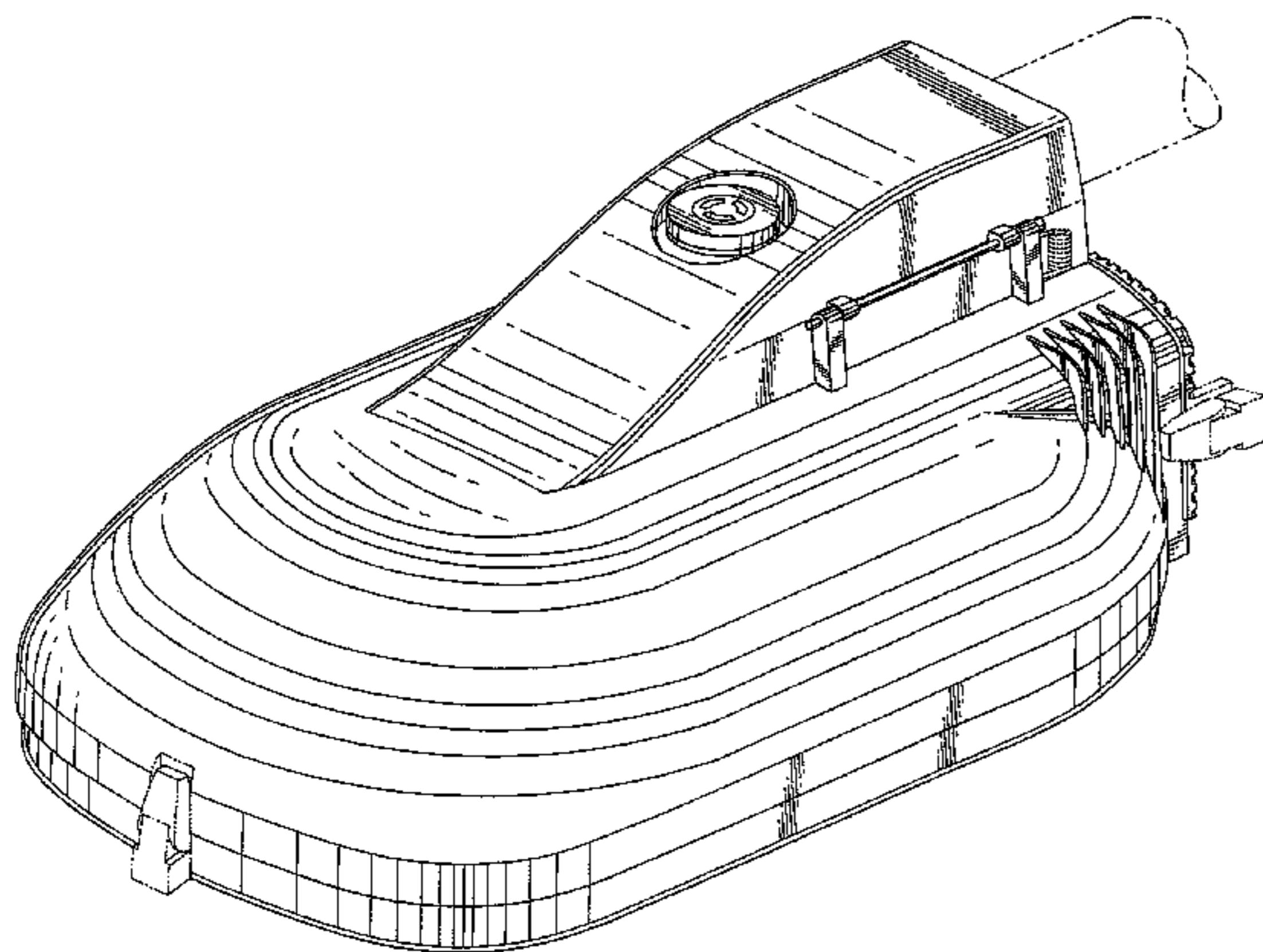

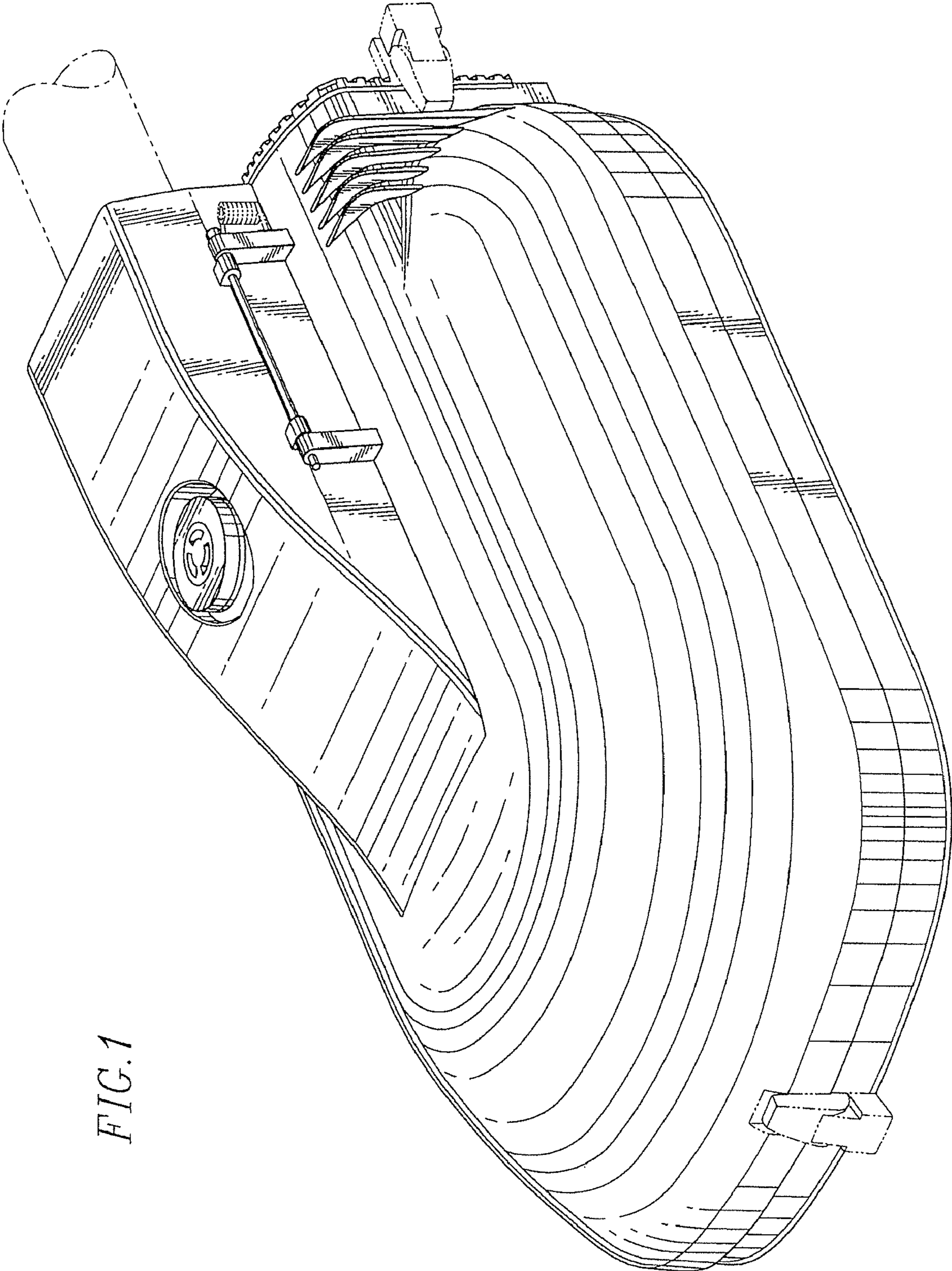
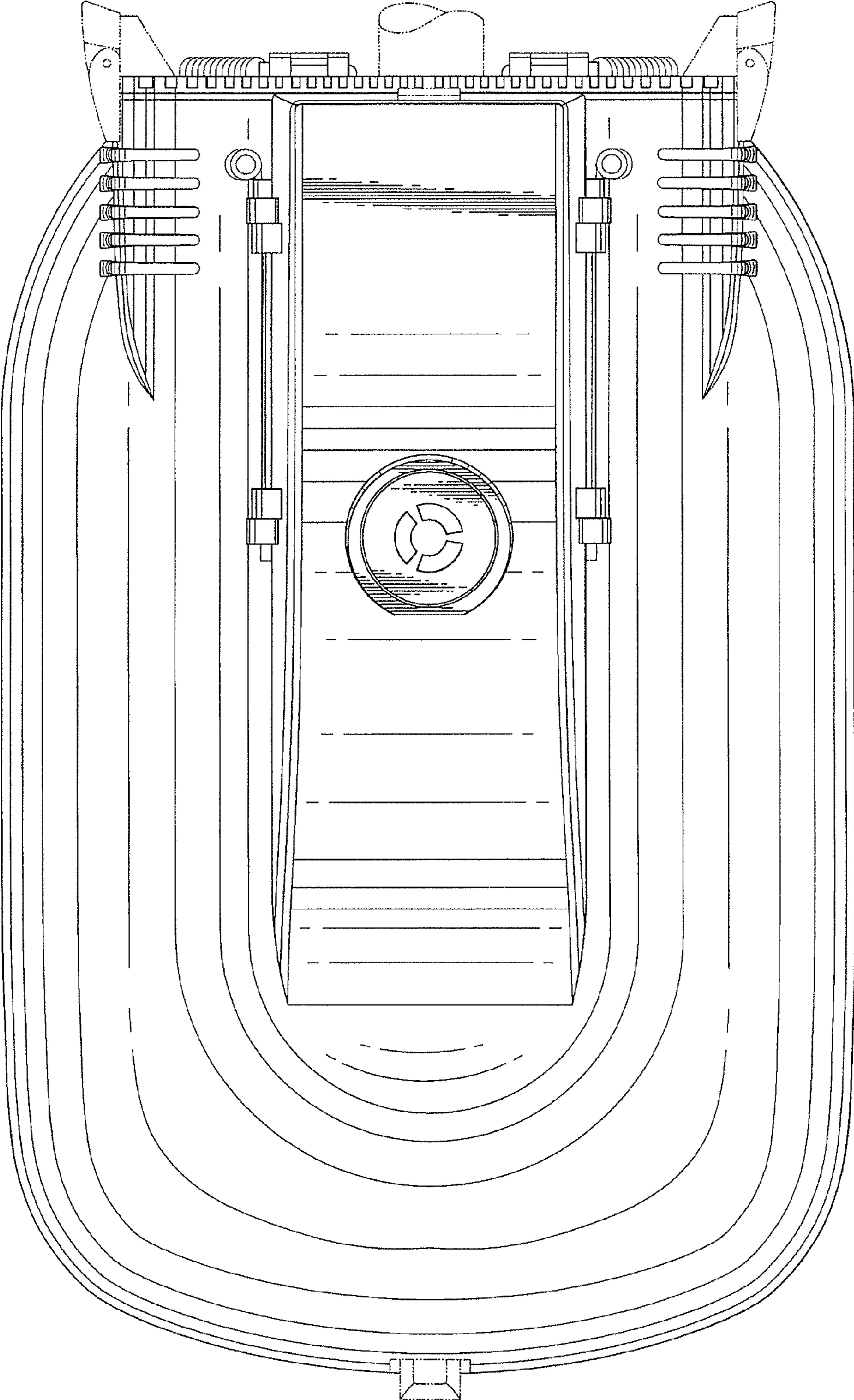

FIG. 1

FIG. 2



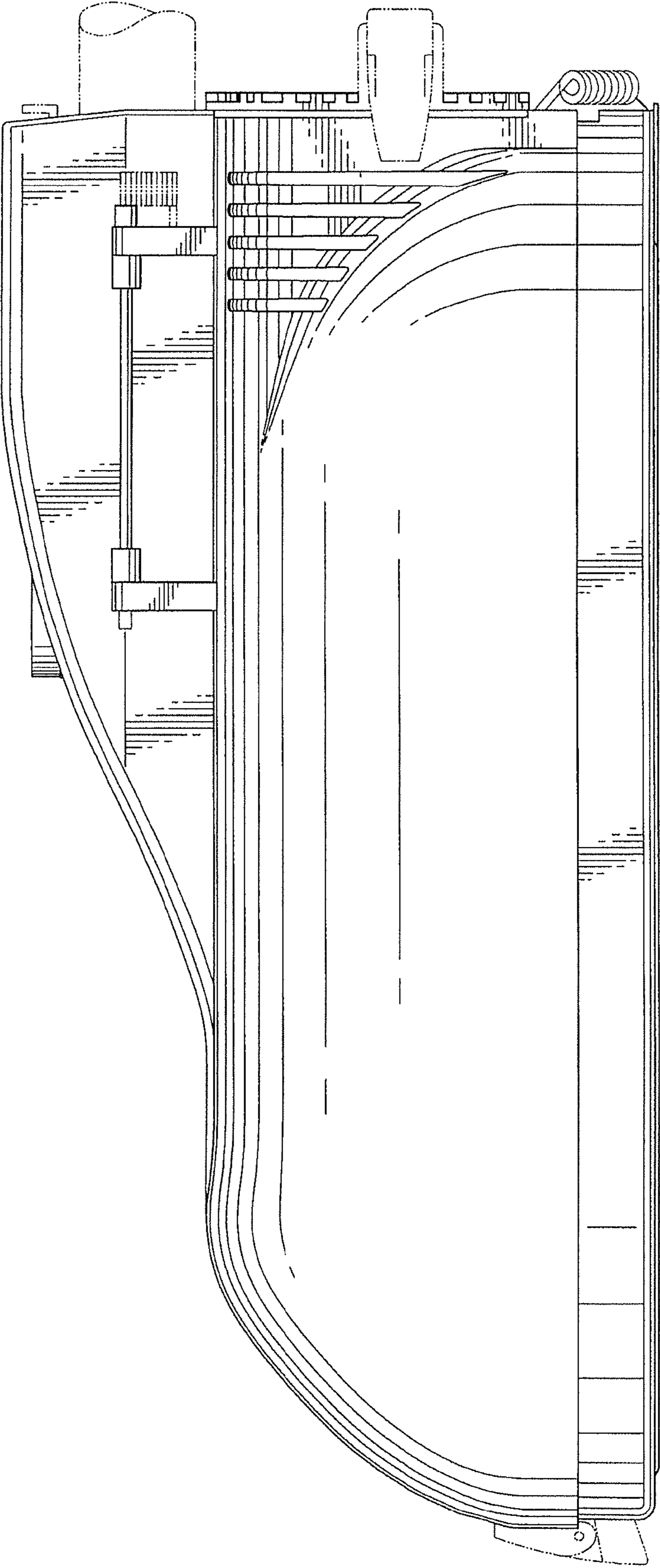

FIG. 3

FIG. 4

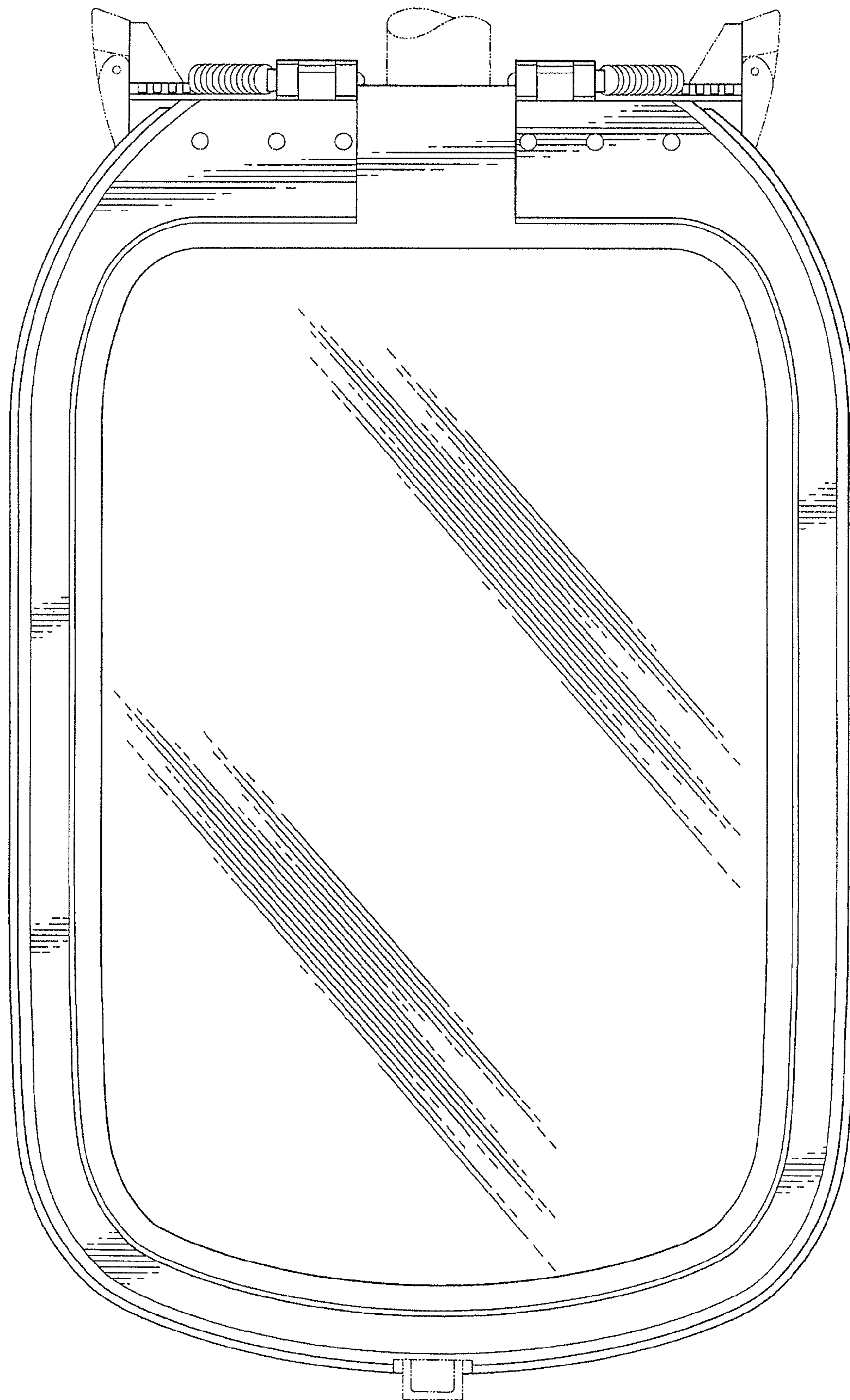

FIG. 5

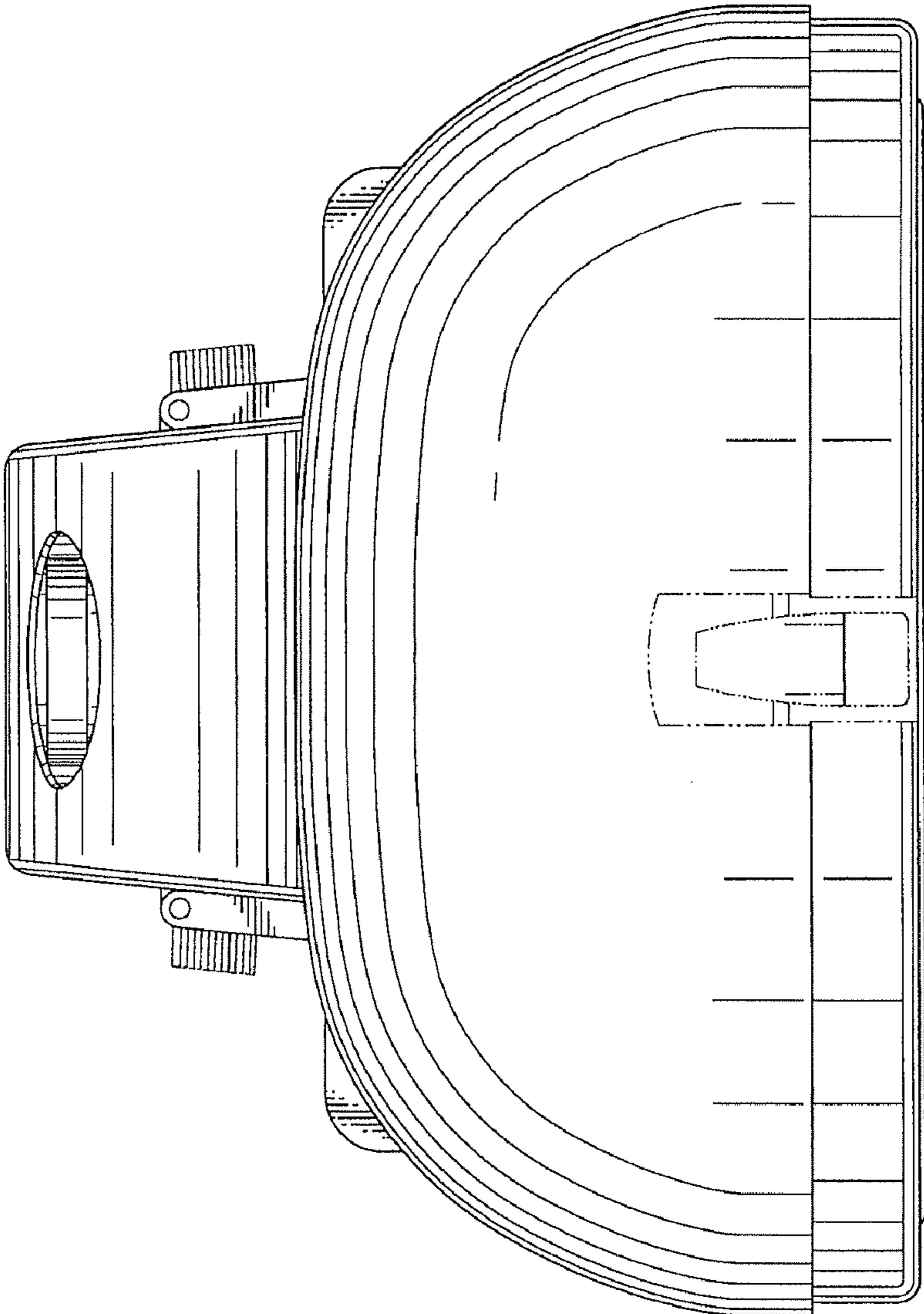

FIG. 6

