



US00D631460S

(12) **United States Design Patent**
Mo et al.

(10) **Patent No.:** **US D631,460 S**
(45) **Date of Patent:** **** Jan. 25, 2011**

(54) **COMMUNICATION DEVICE**

(75) Inventors: **Jia-Jun Mo**, Beijing (CN); **Fu-Yuan Hsu**, Beijing (CN); **Cheng Siong Tee**, Shanghai (CN)

(73) Assignee: **Motorola Mobility, Inc.**, Libertyville, IL (US)

(**) Term: **14 Years**

(21) Appl. No.: **29/362,808**

(22) Filed: **Jun. 1, 2010**

(51) **LOC (9) Cl.** **14-03**

(52) **U.S. Cl.** **D14/138 AB**

(58) **Field of Classification Search** D14/138 AB,
D14/496, 341, 345, 346, 203.3, 203.4, 203.7,
D14/138 R, 248; 455/575.3, 556.2; D21/517;
379/433.01, 433.04, 433.13

See application file for complete search history.

(56) **References Cited**

U.S. PATENT DOCUMENTS

D486,809 S *	2/2004	Hwang	D14/138 AB
D501,189 S *	1/2005	Lodato et al.	D14/138 AB
D502,701 S *	3/2005	Takuma	D14/345
D508,474 S *	8/2005	Ribeiro et al.	D14/138 AB
D513,505 S *	1/2006	Lee	D14/138 AB
D561,158 S *	2/2008	Heng et al.	D14/138 AB
D568,852 S *	5/2008	Park	D14/138 AB
D576,599 S *	9/2008	Han et al.	D14/138 AB
D580,901 S *	11/2008	Su et al.	D14/138 AB
D586,772 S *	2/2009	Su et al.	D14/138 AB
D592,169 S *	5/2009	Kim et al.	D14/138 AB
D592,174 S *	5/2009	Mo et al.	D14/138 AB
D593,523 S *	6/2009	Neumann et al.	D14/138 AB
D593,524 S *	6/2009	Neumann et al.	D14/138 AB
D595,255 S *	6/2009	Cho	D14/138 AB
D596,151 S *	7/2009	Lee	D14/138 AB

7,561,687 B2 *	7/2009	Duan et al.	379/433.13
D598,000 S *	8/2009	Kim et al.	D14/138 AB
D598,421 S *	8/2009	Kim et al.	D14/138 AB
D602,895 S *	10/2009	Chun	D14/138 AD
D602,896 S *	10/2009	Finney et al.	D14/138 AB
D602,897 S *	10/2009	Finney et al.	D14/138 AB
D605,156 S *	12/2009	Kim et al.	D14/138 AB
D610,108 S *	2/2010	Lee	D14/138 AB
D613,710 S *	4/2010	Kim et al.	D14/138 AB
2004/0192220 A1 *	9/2004	Huang et al.	455/74
2006/0105820 A1 *	5/2006	Takahashi	455/575.1

OTHER PUBLICATIONS

“Motorola A1600 Motoming 2 pops up on Chinese site”, posted Dec. 13, 2007, [online], [site visited Jan. 9, 2009]. Available from Internet, <URL: <http://www.unwiredview.com/2007/12/13/motorola-a1600-motoming-2-pops-up-on-chinese-site/>>.*

“Motorola launches Ming/A1200 smartphone”, posted Mar. 17, 2006, [online], [site visited Jan. 9, 2009]. Available from Internet, <URL: <http://www.unwiredview.com/2006/03/17/motorola-minga1200-smartphone-motoming/>>.*

Motorola A1680 telephone, announced Jul. 2010, [online], [site visited Aug. 17, 2010]. Available from Internet, <URL: <http://www.gsmarena.com>>.*

Motorola A1210 telephone, announced Apr. 2009, [online], [site visited Aug. 17, 2010]. Available from Internet, <URL: <http://www.gsmarena.com>>.*

Motorola A1600 telephone, announced Jun. 2008, [online], [site visited Aug. 17, 2010]. Available from Internet, <URL: <http://www.gsmarena.com>>.*

Motorola A1800 telephone, announced Jun. 2008, [online], [site visited Aug. 17, 2010]. Available from Internet, <URL: <http://www.gsmarena.com>>.*

Motorola A768i telephone, announced 1st quarter 2004, [online], [site visited Aug. 17, 2010]. Available from Internet, <URL: <http://www.gsmarena.com>>.*

Bird M01 telephone, announced 2007, [online], [site visited Aug. 17, 2010]. Available from Internet, <URL: <http://www.gsmarena.com>>.*

Samsung T539 Beat telephone, announced Oct. 2007, [online], [site visited Aug. 17, 2010]. Available from Internet, <URL: <http://www.gsmarena.com>>.*

* cited by examiner

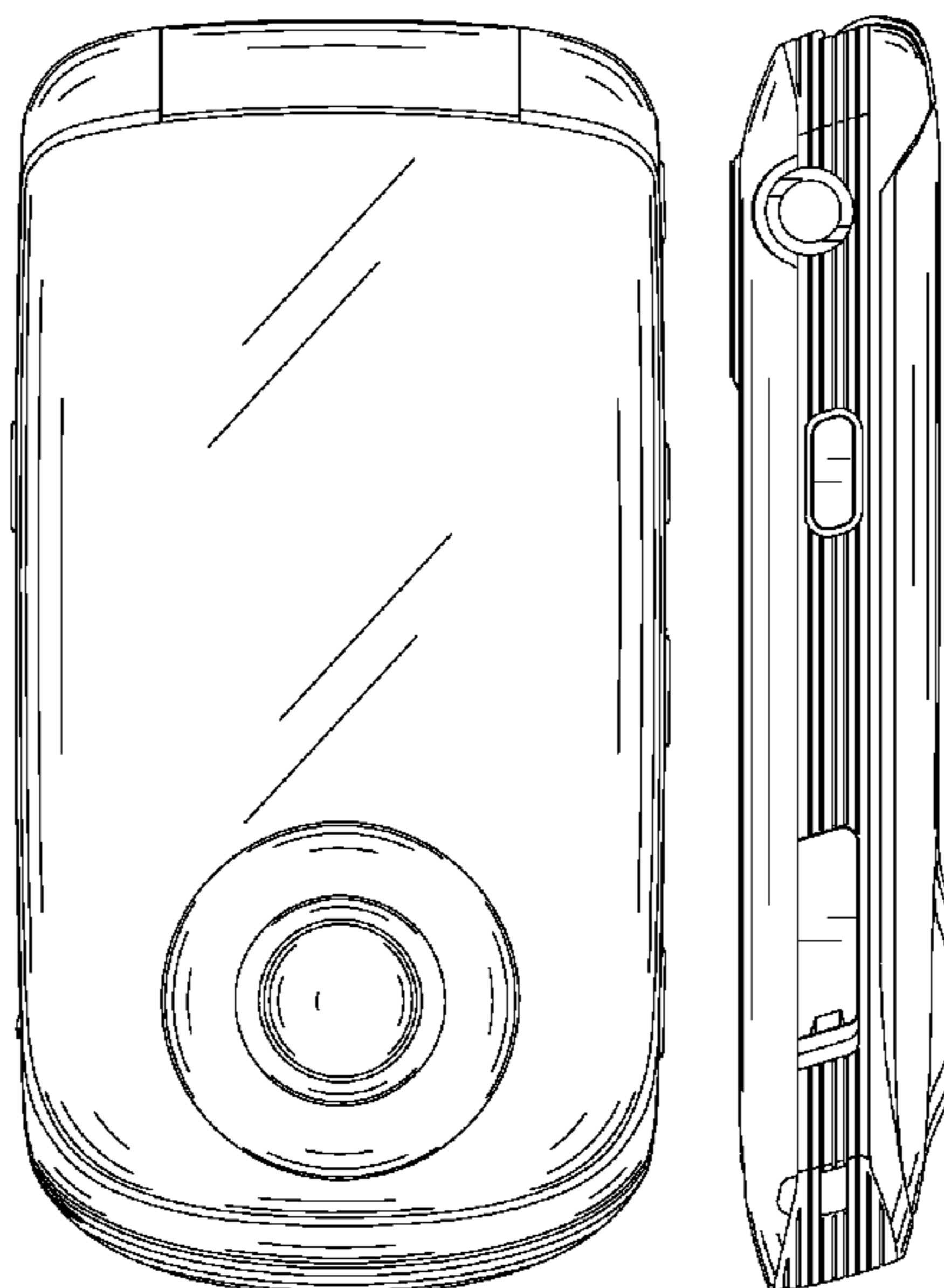

Primary Examiner—Jeffrey D Asch

(57)

CLAIM

The ornamental design for a communication device, as shown and described.

DESCRIPTION

FIG. 1 is a front perspective view of a first embodiment of an ornamental design for a communication device;

FIG. 2 is a rear perspective view of the first embodiment thereof;

FIG. 3 is a front view of the first embodiment thereof;

FIG. 4 is a rear view of the first embodiment thereof;

FIG. 5 is a first side view of the first embodiment thereof;

FIG. 6 is a second side view of the first embodiment thereof;

FIG. 7 is a top view of the first embodiment thereof; and

FIG. 8 is a bottom view of the first embodiment thereof.

FIG. 9 is a front perspective view of a second embodiment of an ornamental design for a communication device;

FIG. 10 is a rear perspective view of the second embodiment thereof;

FIG. 11 is a front view of the second embodiment thereof;

FIG. 12 is a rear view of the second embodiment thereof;

FIG. 13 is a first side view of the second embodiment thereof;

FIG. 14 is a second side view of the second embodiment thereof;

FIG. 15 is a top view of the second embodiment thereof; and

FIG. 16 is a bottom view of the second embodiment thereof.

FIG. 17 is a front perspective view of a third embodiment of an ornamental design for a communication device;

FIG. 18 is a rear perspective view of the third embodiment thereof;

FIG. 19 is a front view of the third embodiment thereof;

FIG. 20 is a rear view of the third embodiment thereof;

FIG. 21 is a first side view of the third embodiment thereof;

FIG. 22 is a second side view of the third embodiment thereof;

FIG. 23 is a top view of the third embodiment thereof; and

FIG. 24 is a bottom view of the third embodiment thereof.

FIG. 25 is a front perspective view of a fourth embodiment of an ornamental design for a communication device;

FIG. 26 is a rear perspective view of the fourth embodiment thereof;

FIG. 27 is a front view of the fourth embodiment thereof;

FIG. 28 is a rear view of the fourth embodiment thereof;

FIG. 29 is a first side view of the fourth embodiment thereof;

FIG. 30 is a second side view of the fourth embodiment thereof;

FIG. 31 is a top view of the fourth embodiment thereof; and,

FIG. 32 is a bottom view of the fourth embodiment thereof.

The broken lines shown in FIGS. 1-8 and 17-24 that are immediately adjacent to the shaded areas and define unshaded regions, represent the bounds of the first and third embodiments, while all other broken lines are directed to environment and are for illustrative purposes only; the broken lines form no part of the first and third embodiments.

1 Claim, 20 Drawing Sheets

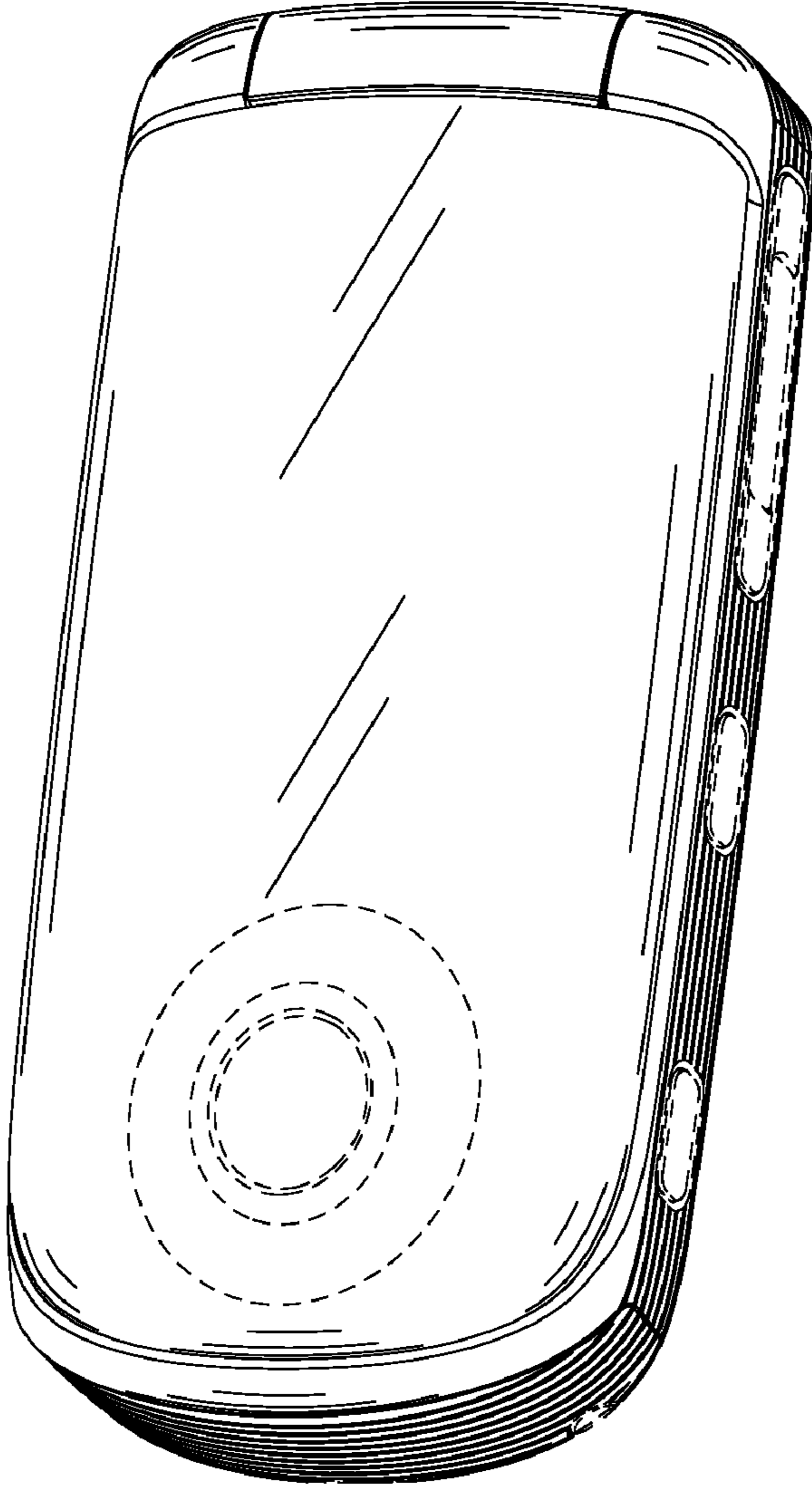

FIG. 1

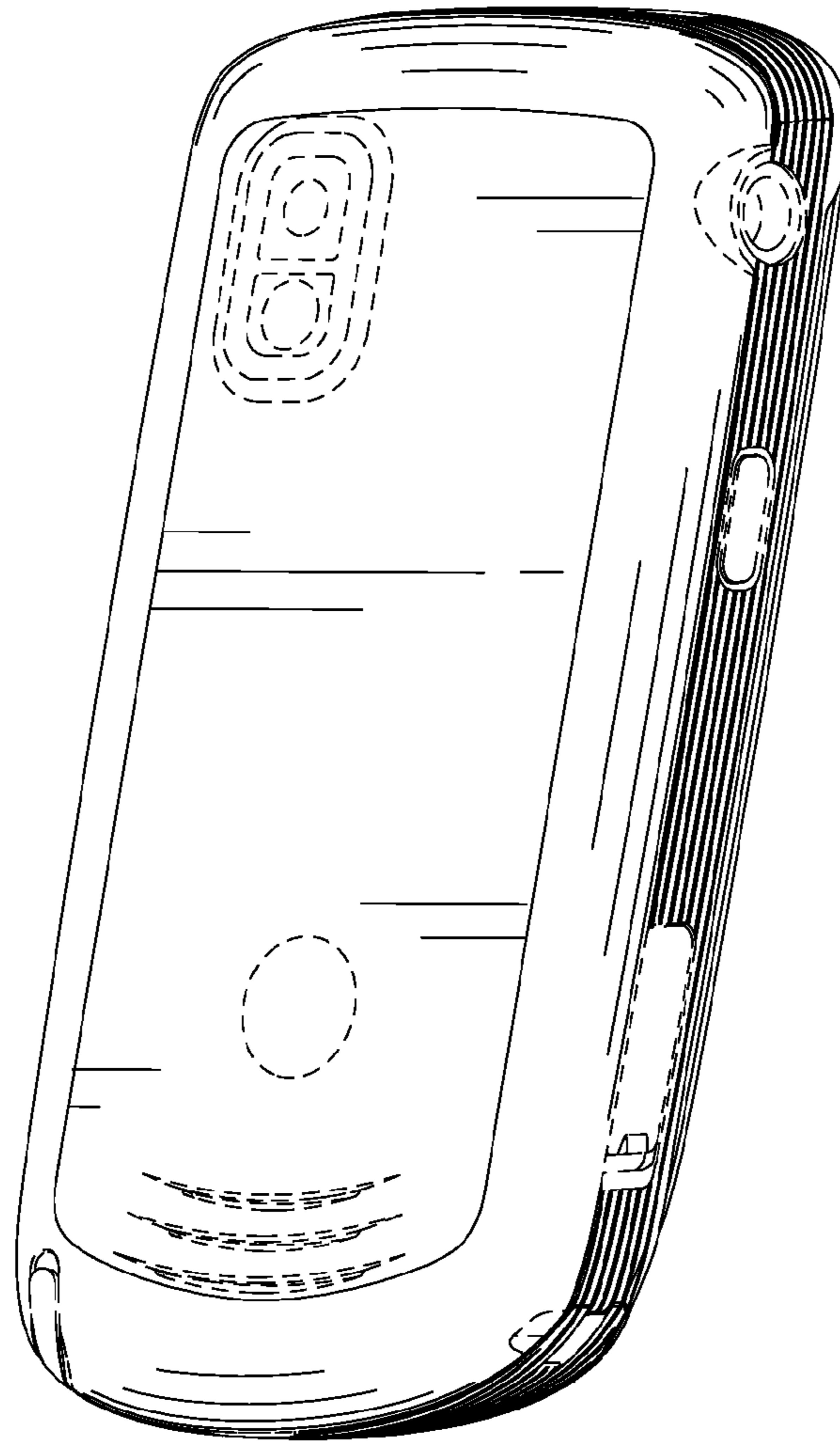

FIG. 2

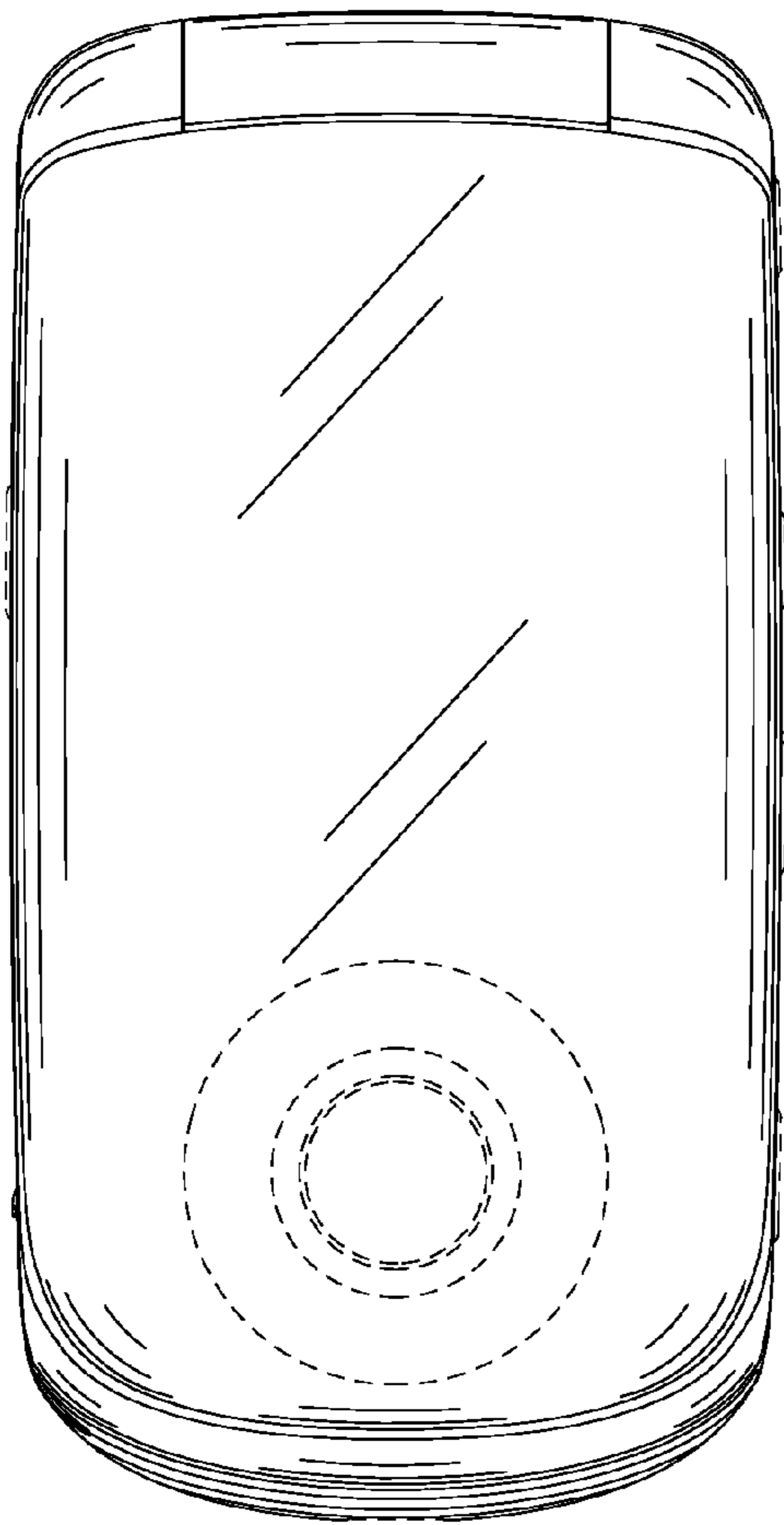

FIG. 3

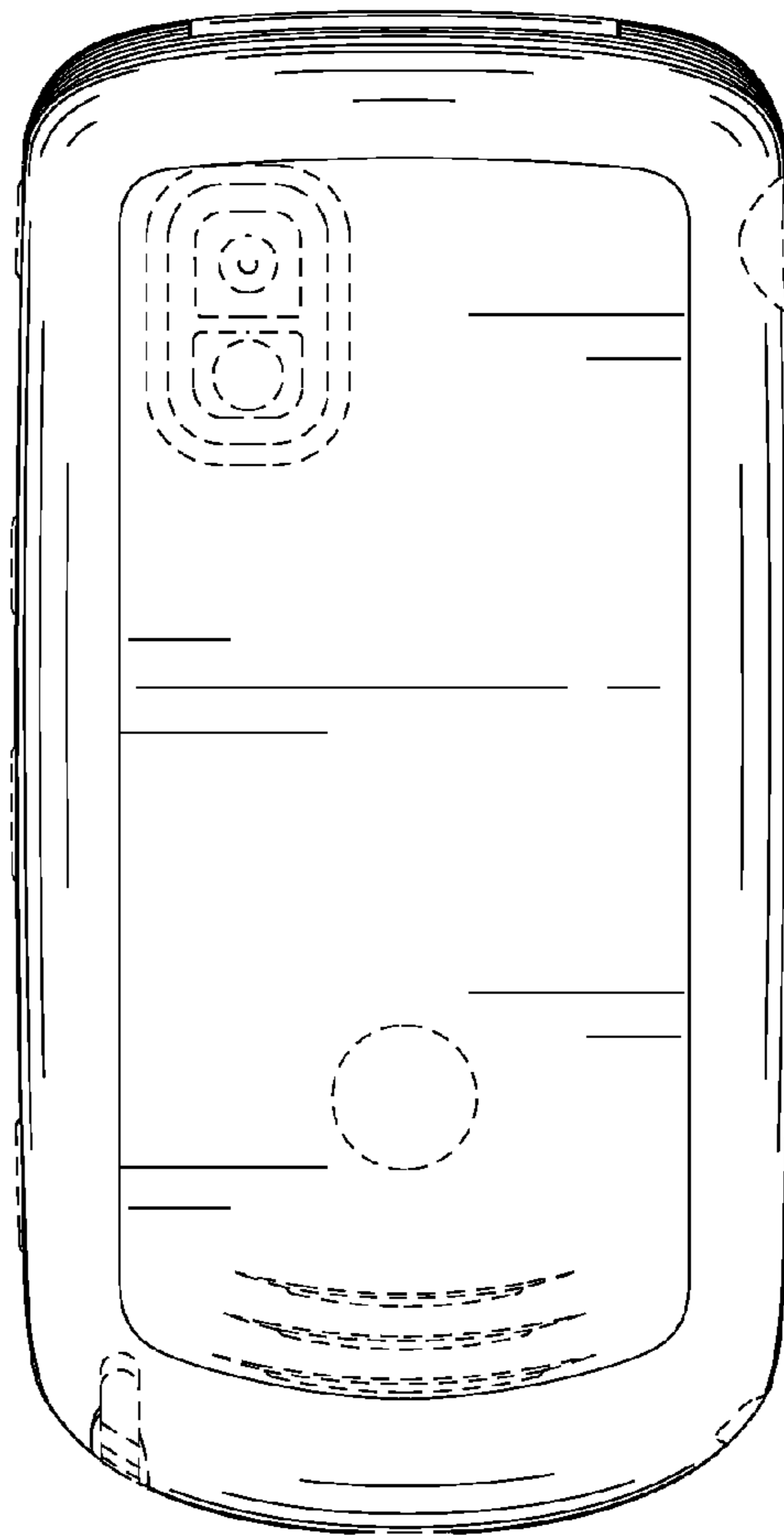

FIG. 4

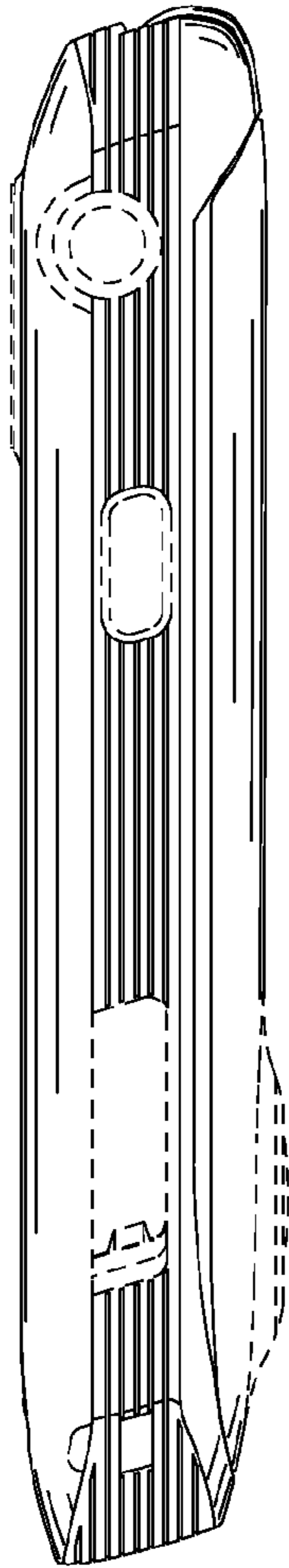

FIG. 5

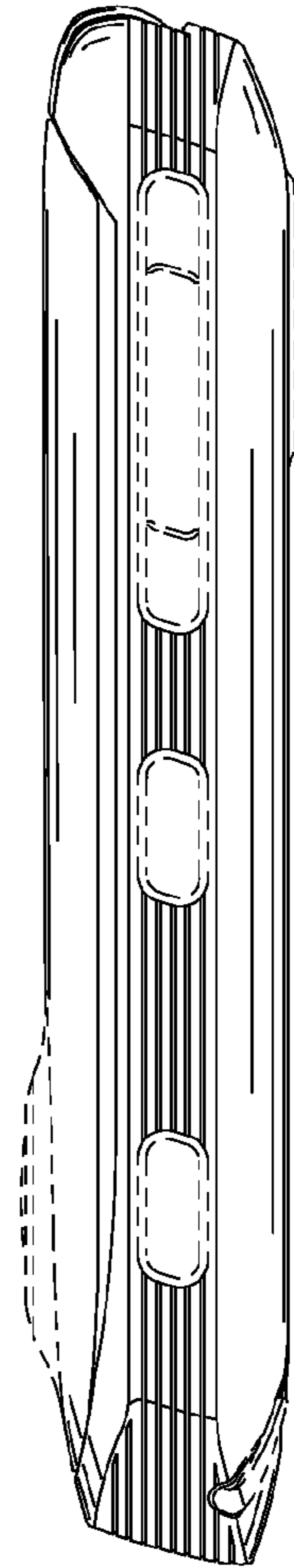

FIG. 6

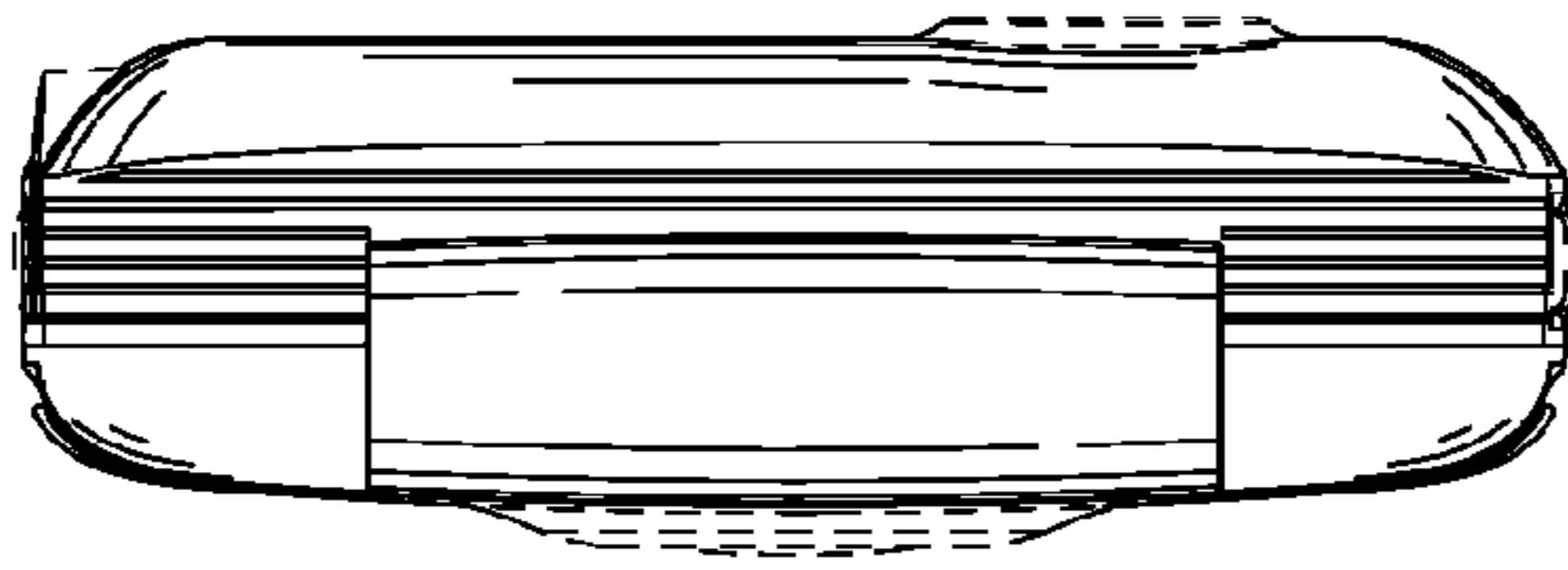

FIG. 7

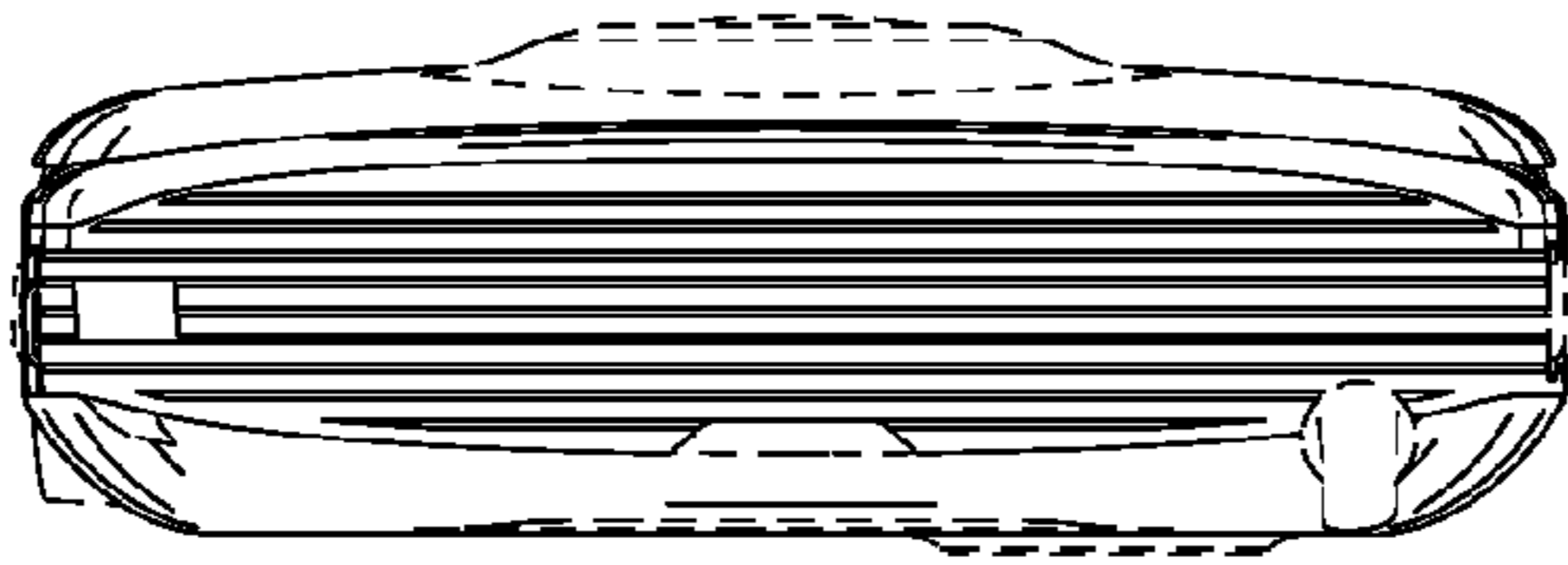

FIG. 8

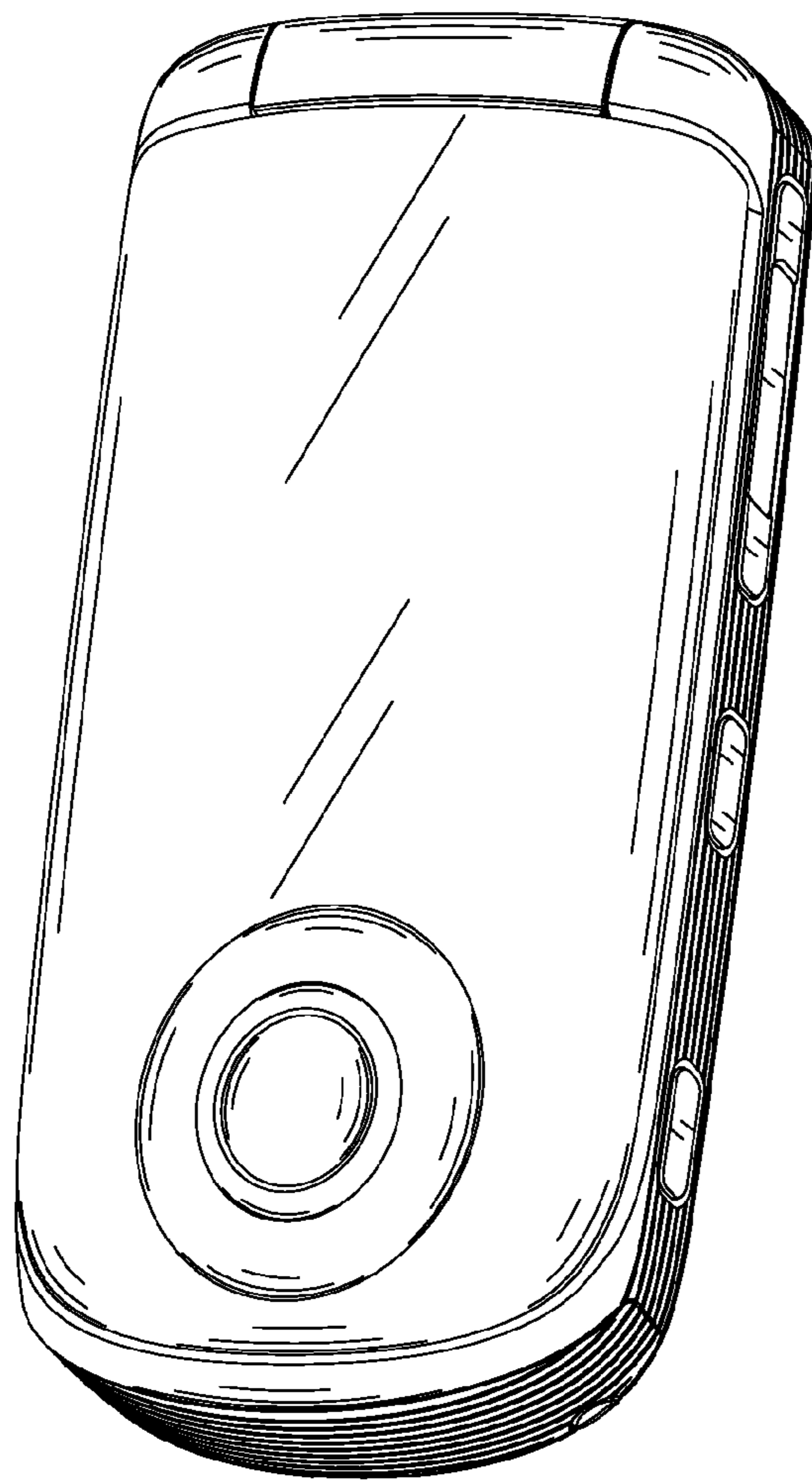

FIG. 9

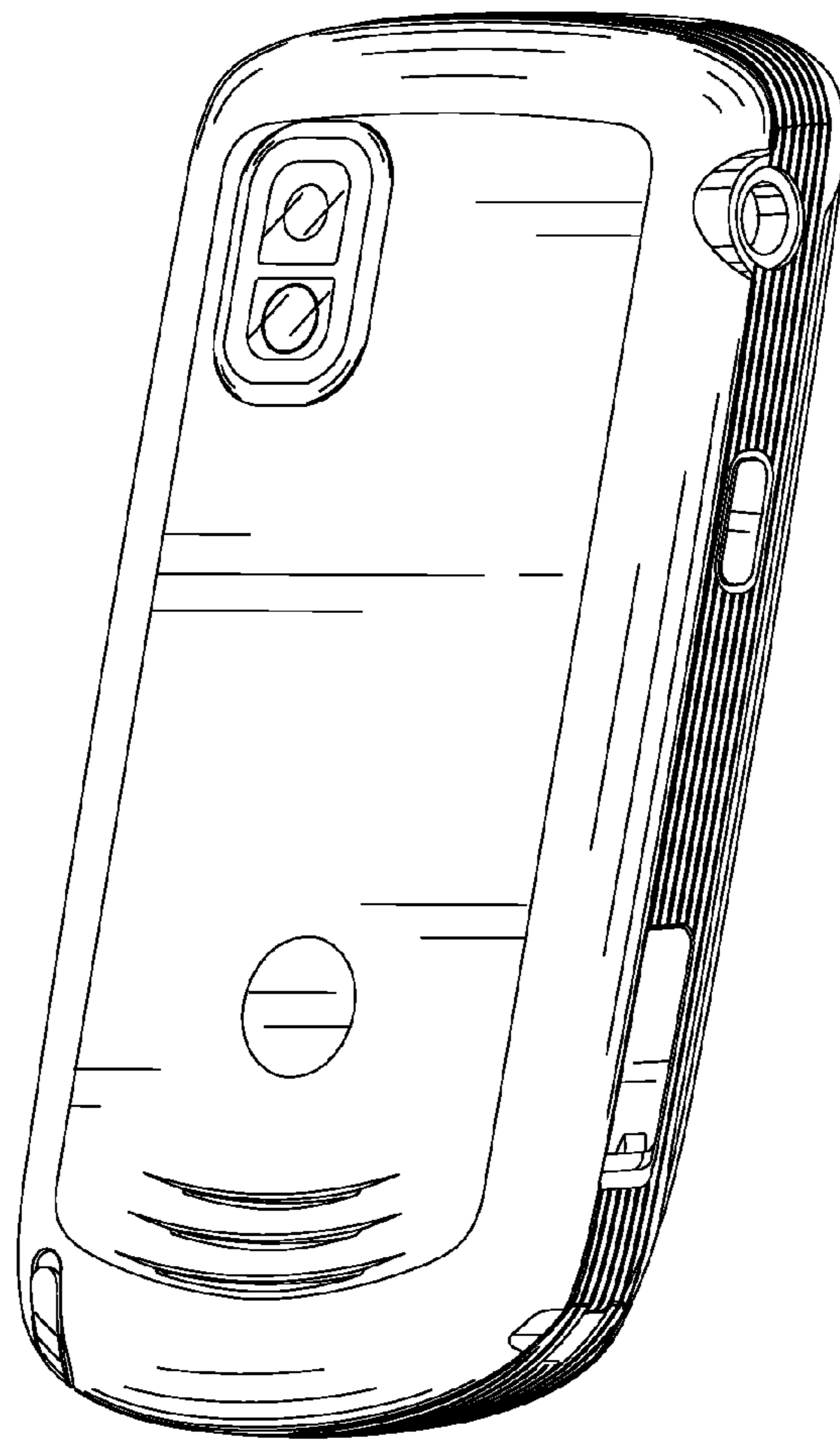

FIG. 10

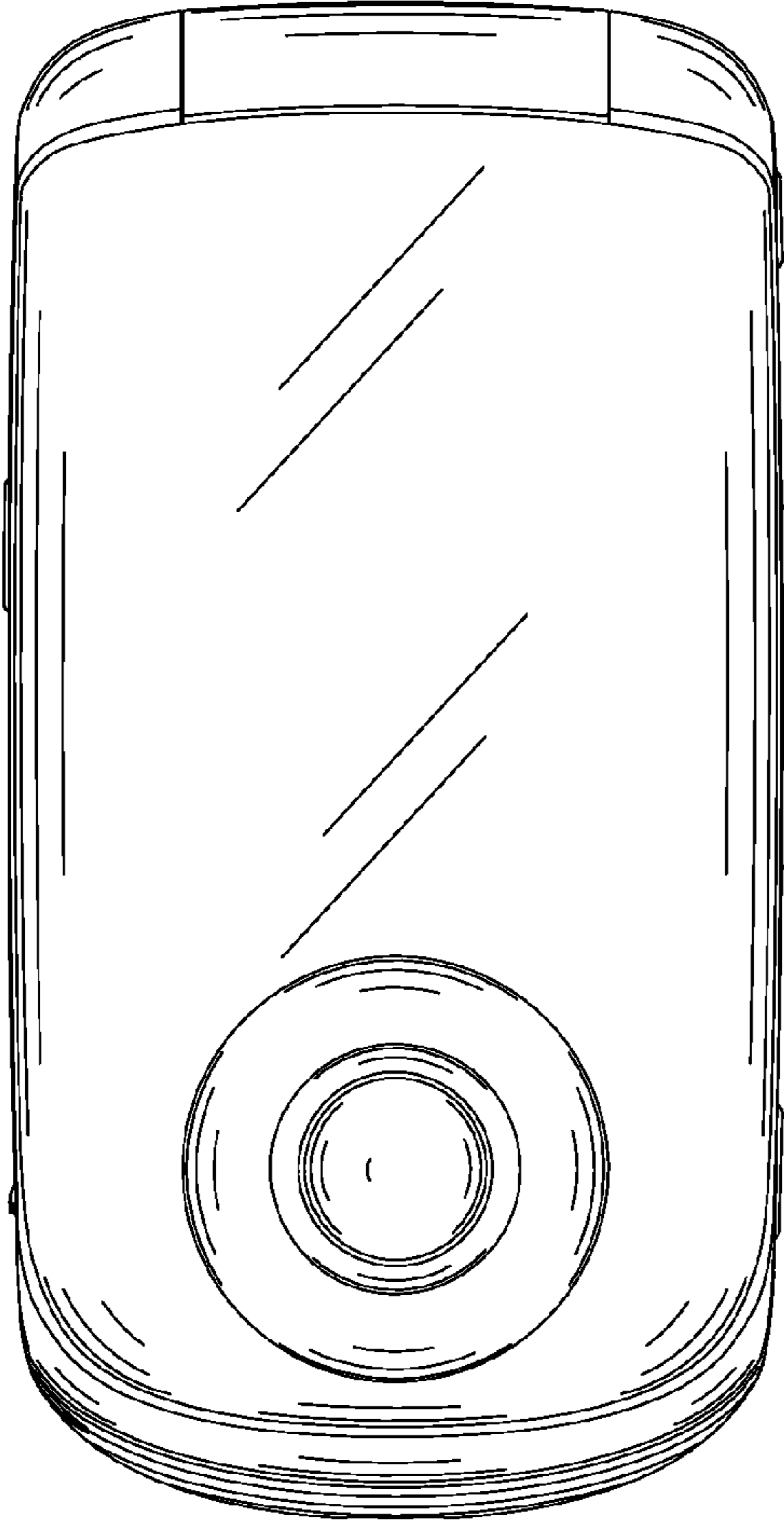

FIG. 11

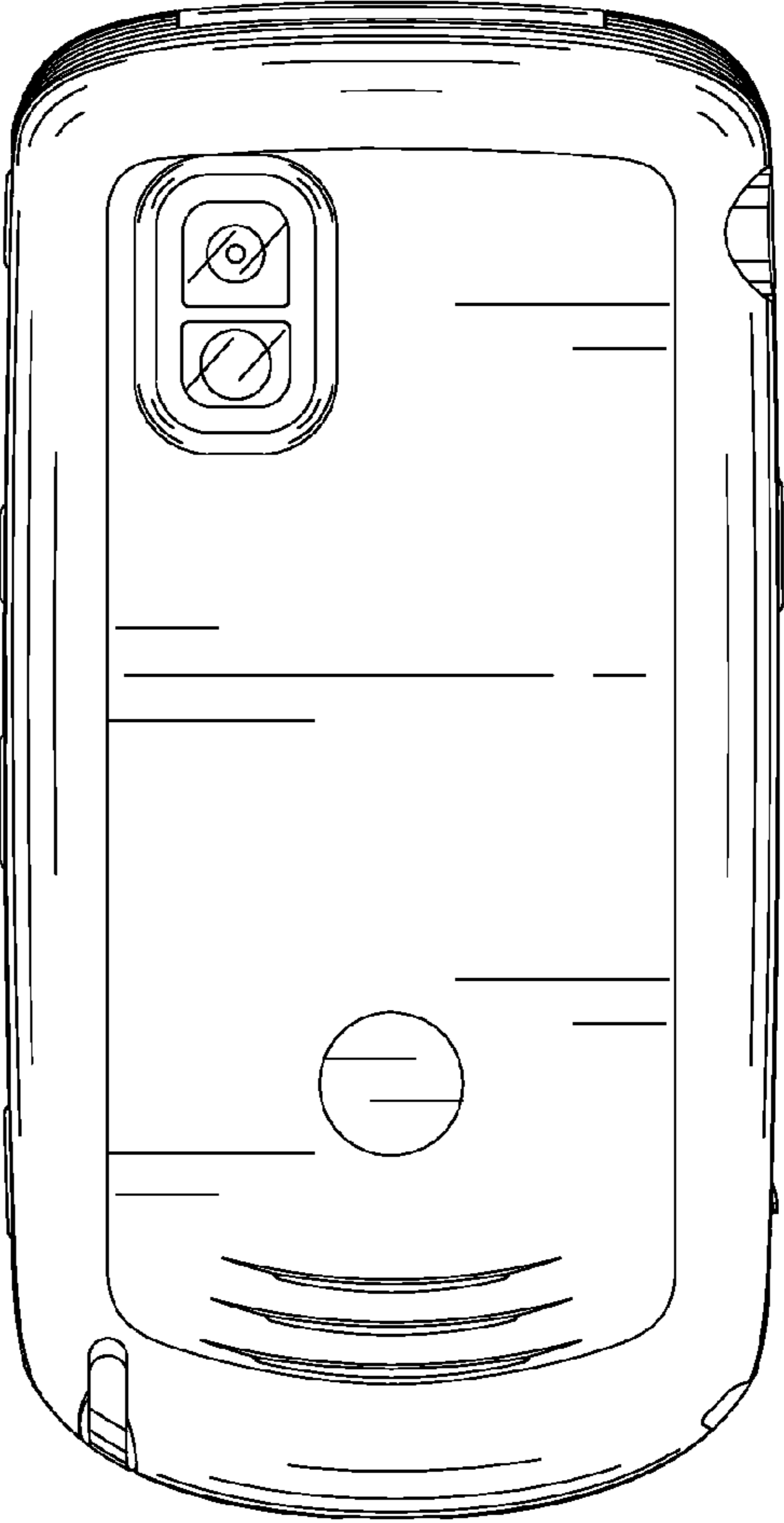

FIG. 12

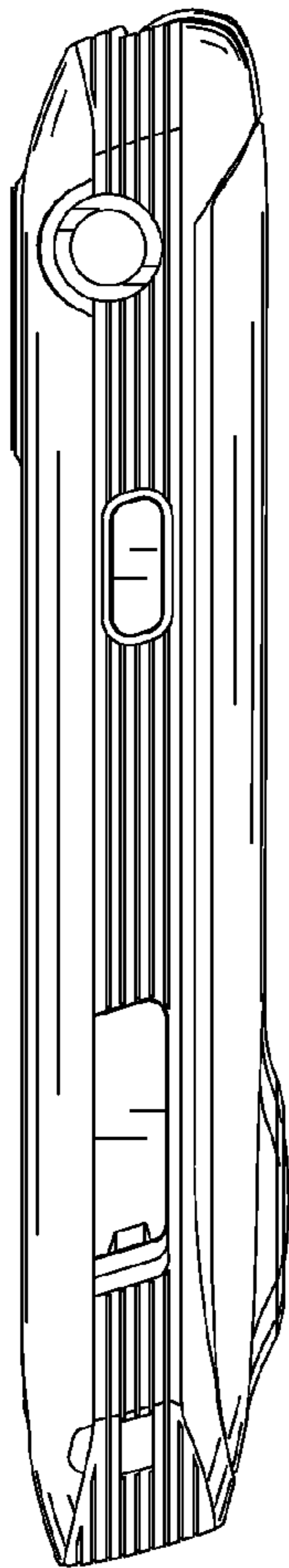

FIG. 13

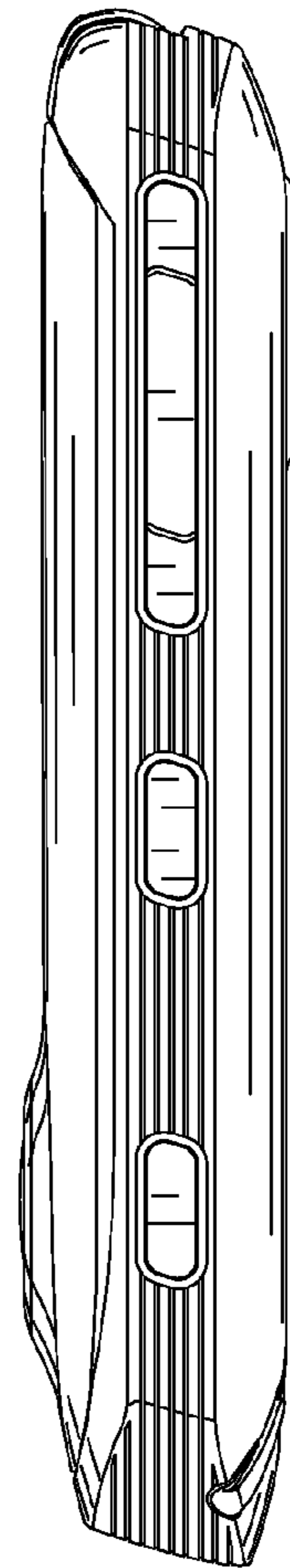

FIG. 14

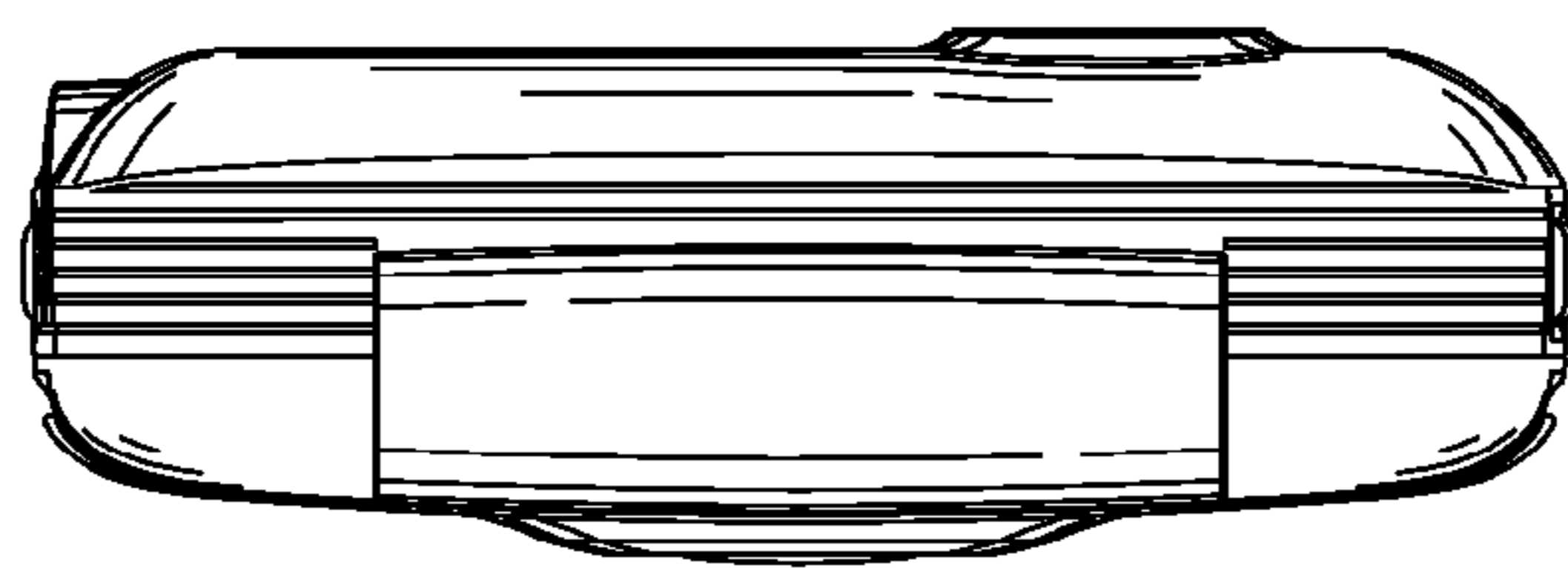

FIG. 15

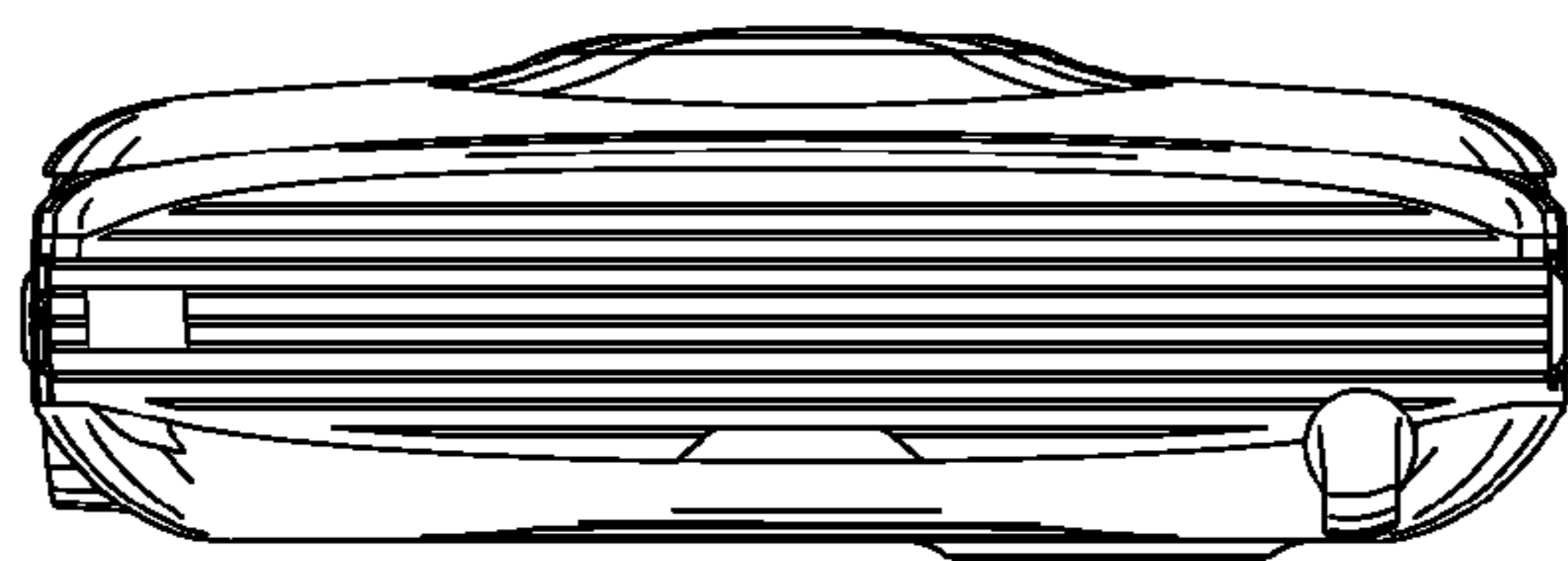

FIG. 16

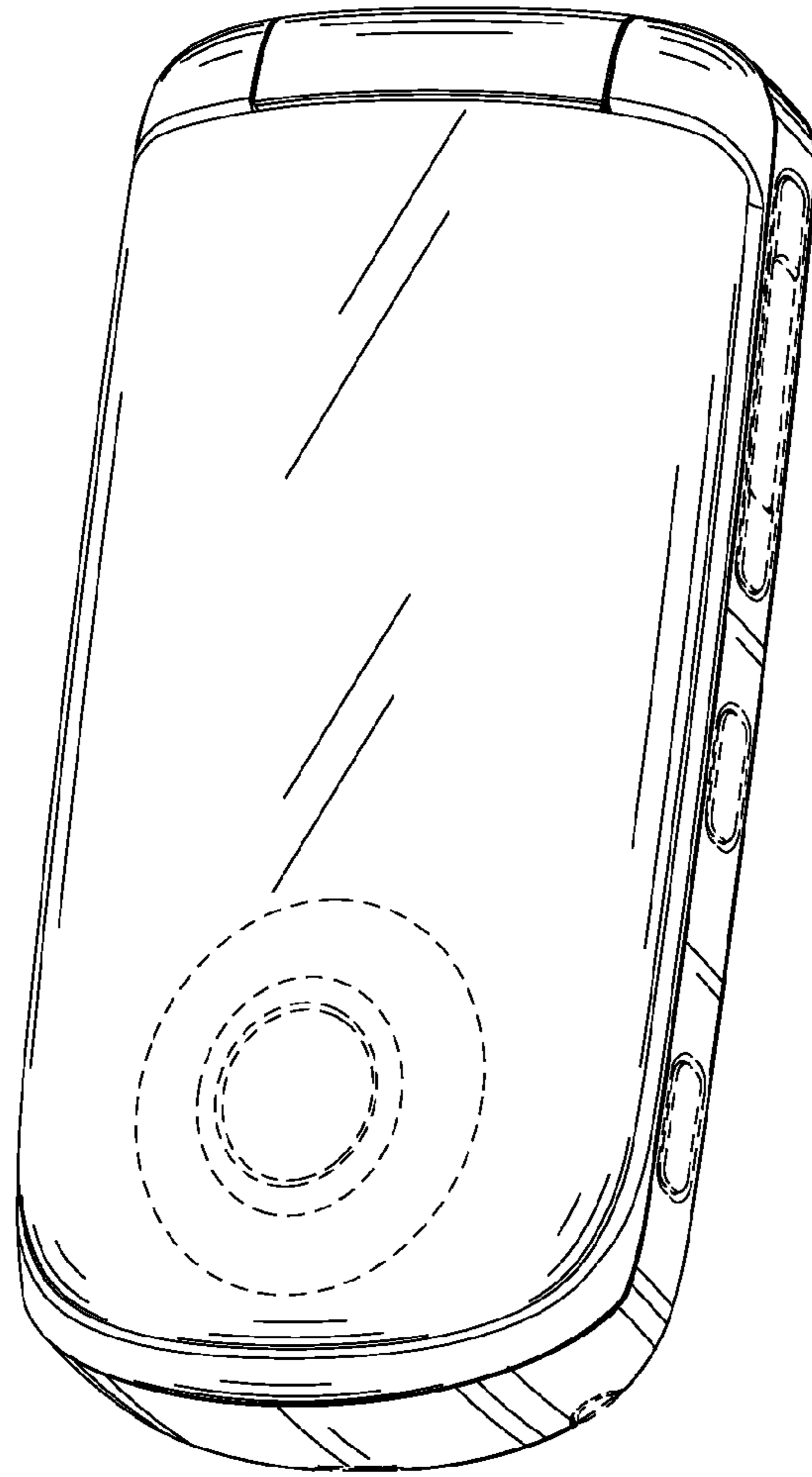

FIG. 17

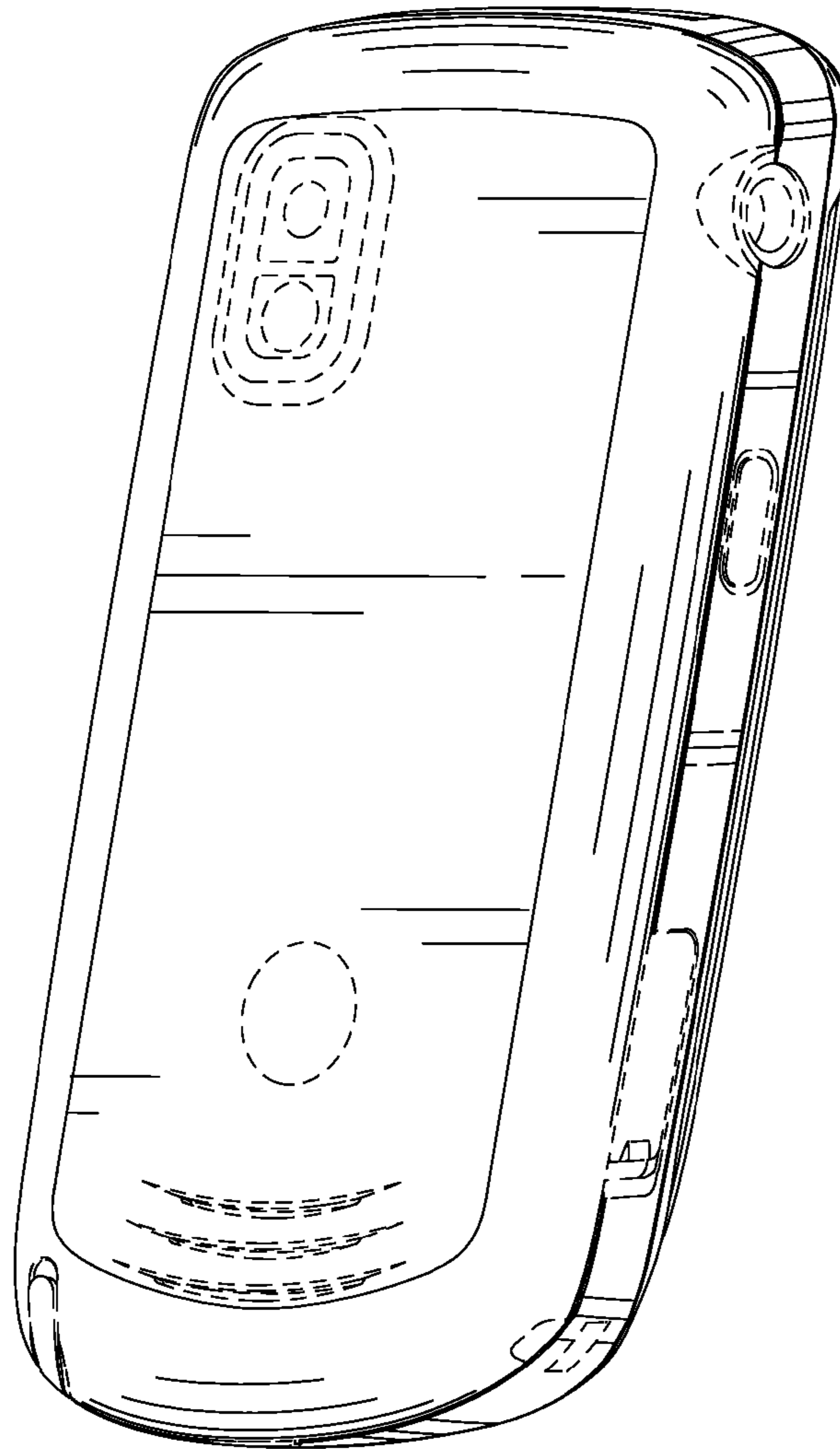

FIG. 18

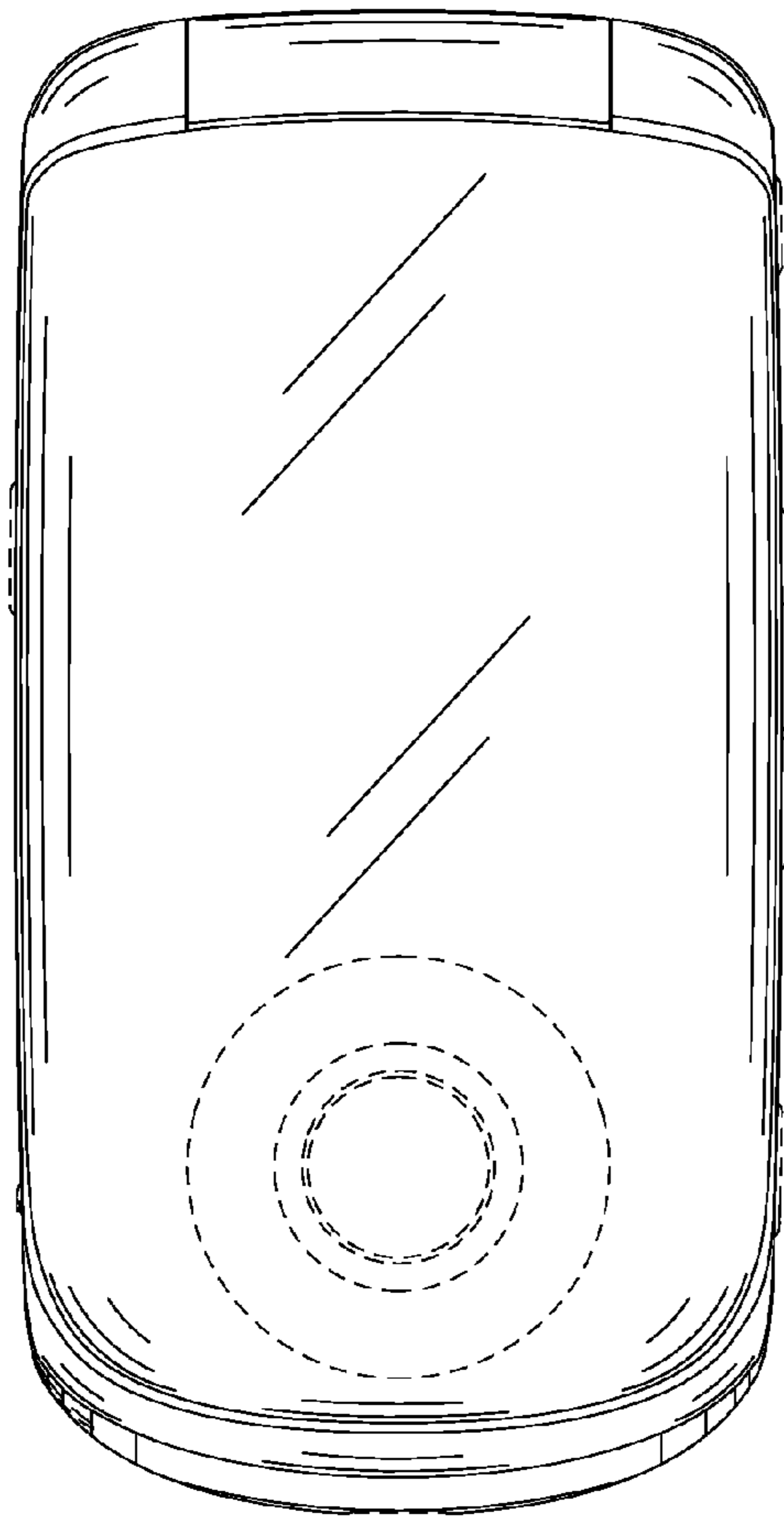

FIG. 19

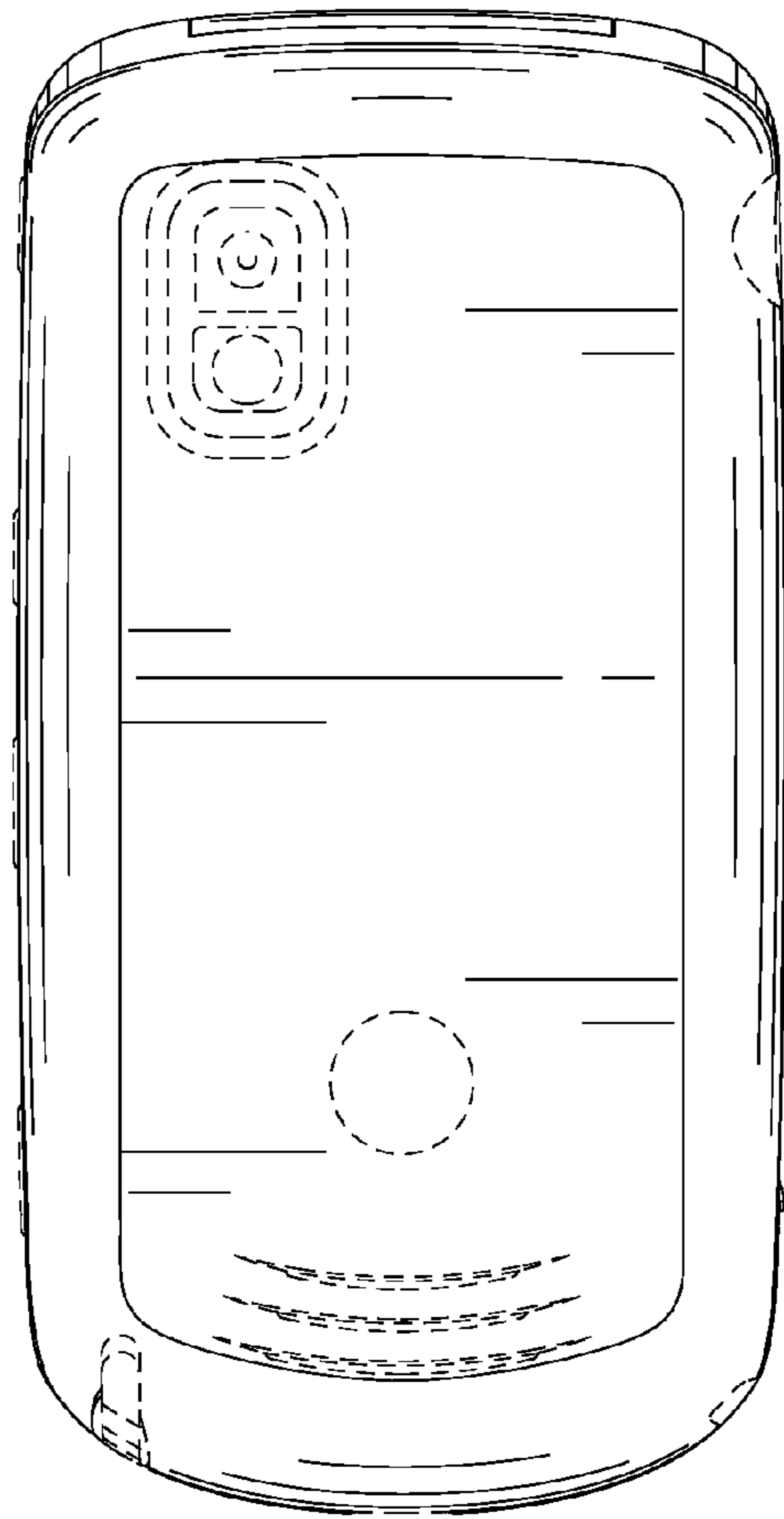

FIG. 20

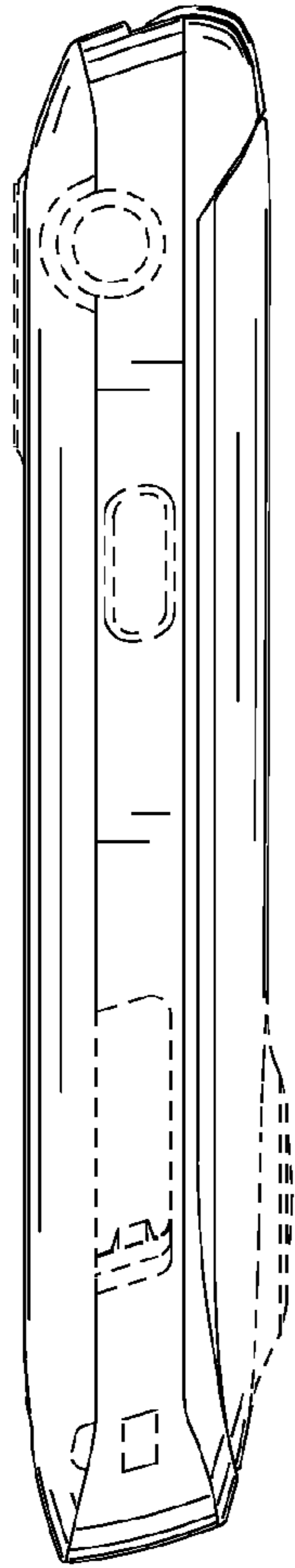

FIG. 21

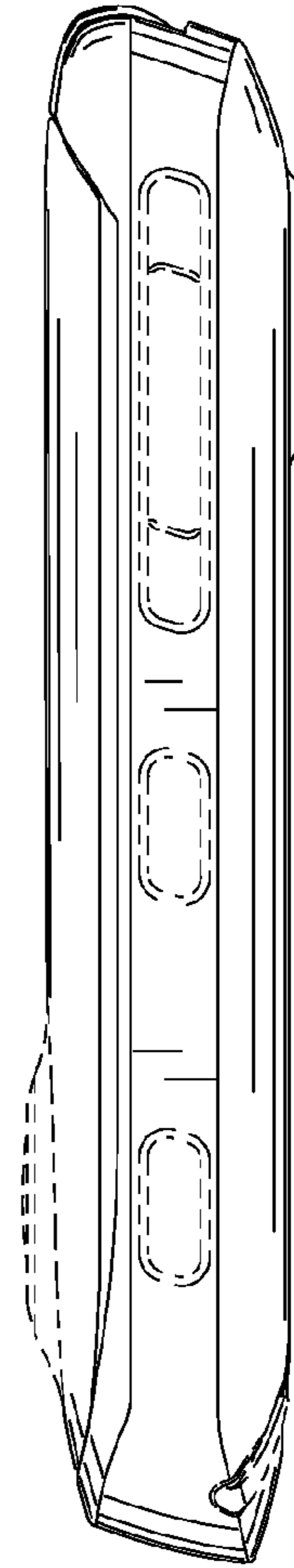

FIG. 22

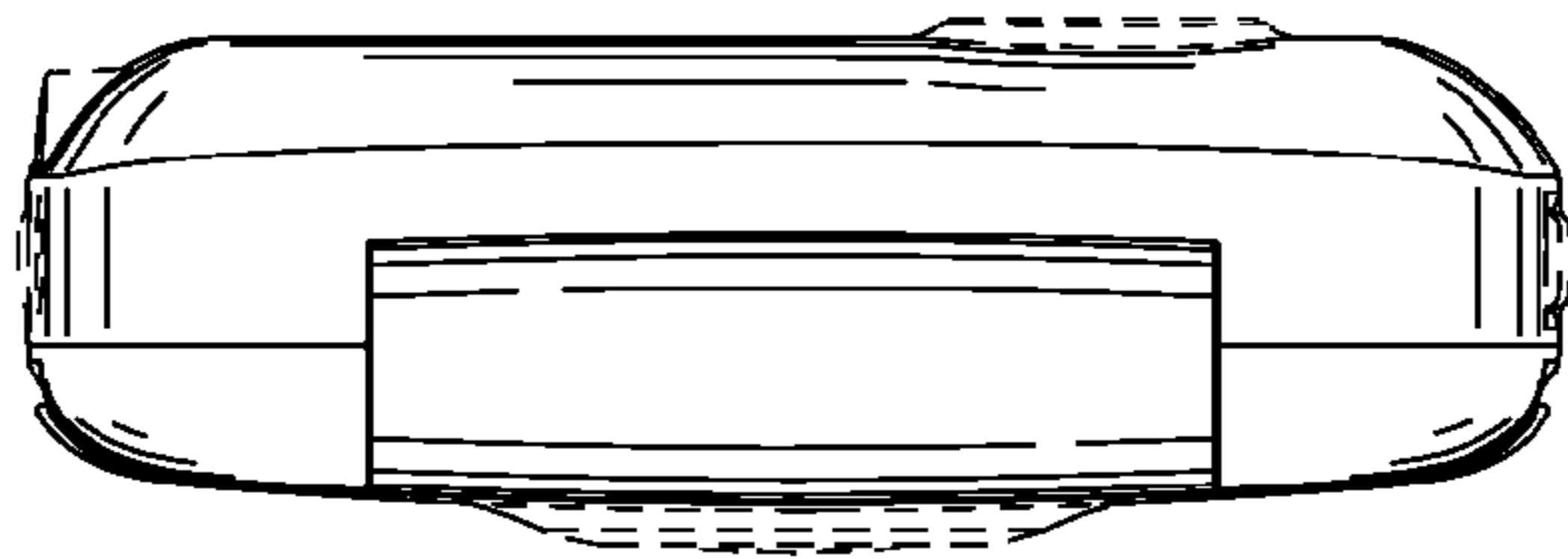

FIG. 23

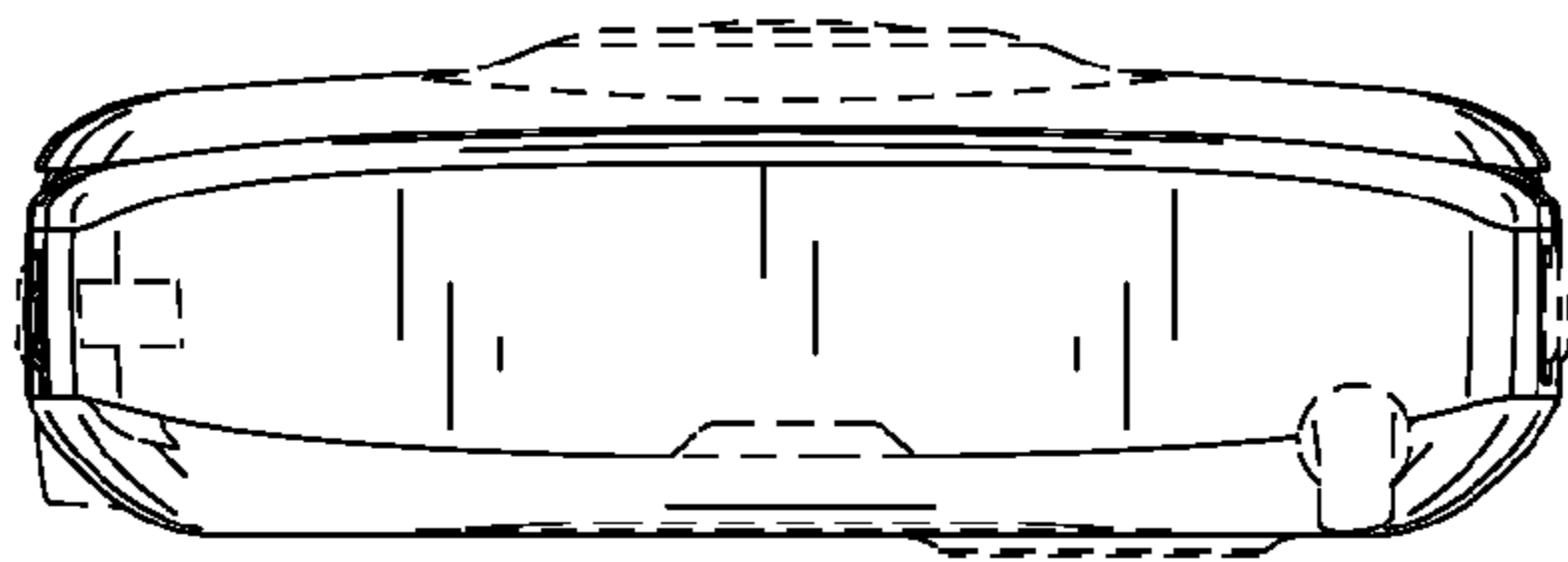

FIG. 24

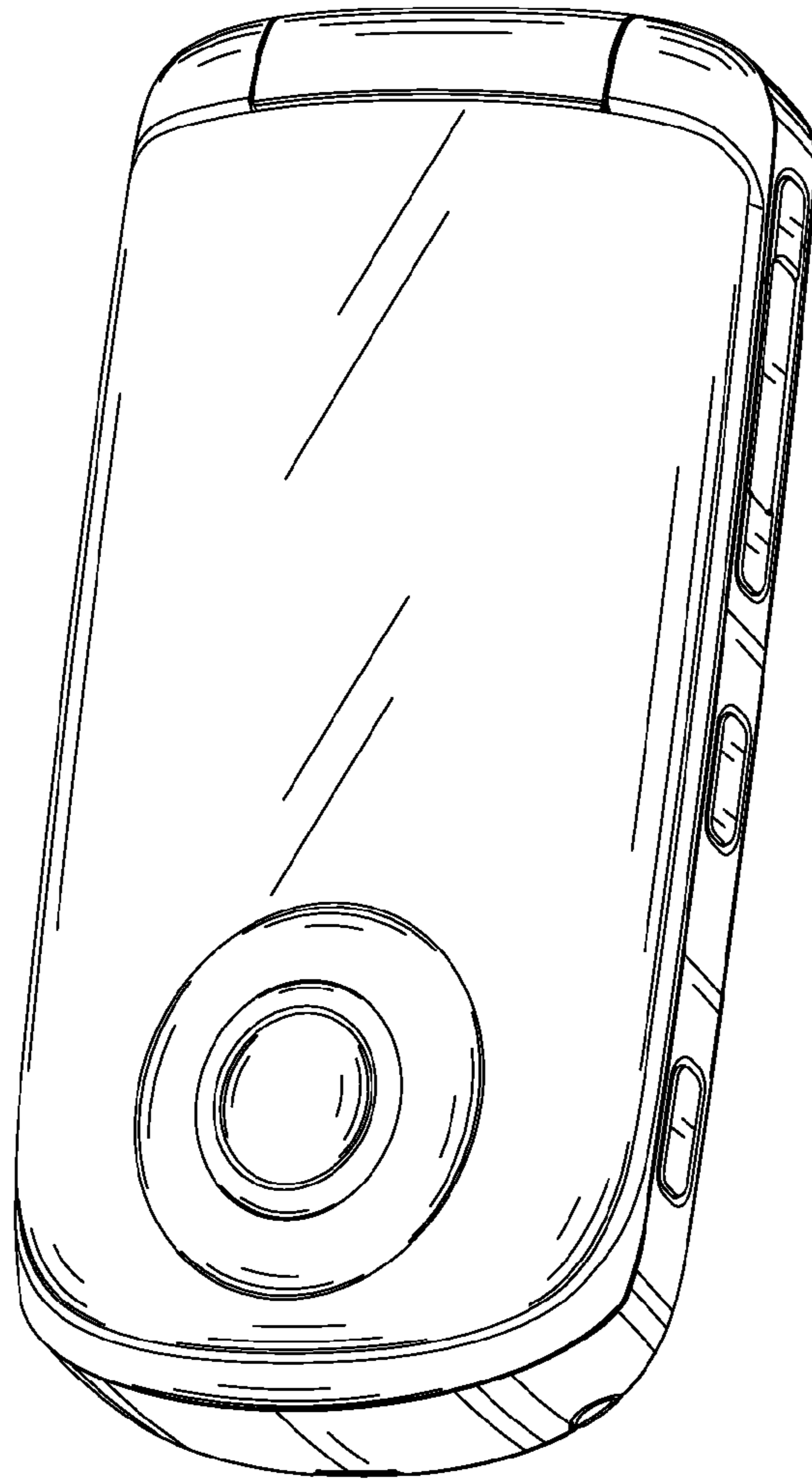

FIG. 25

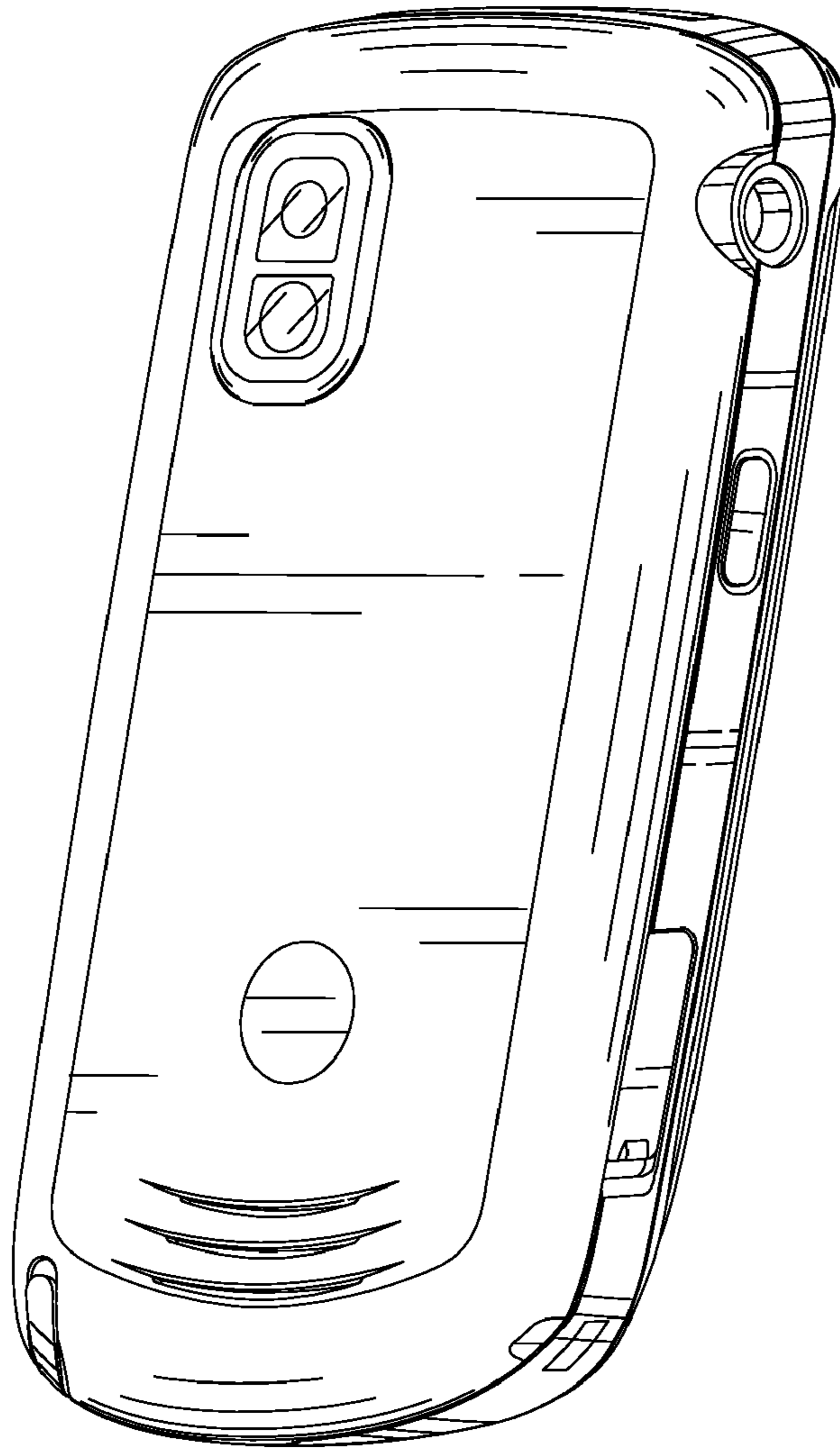

FIG. 26

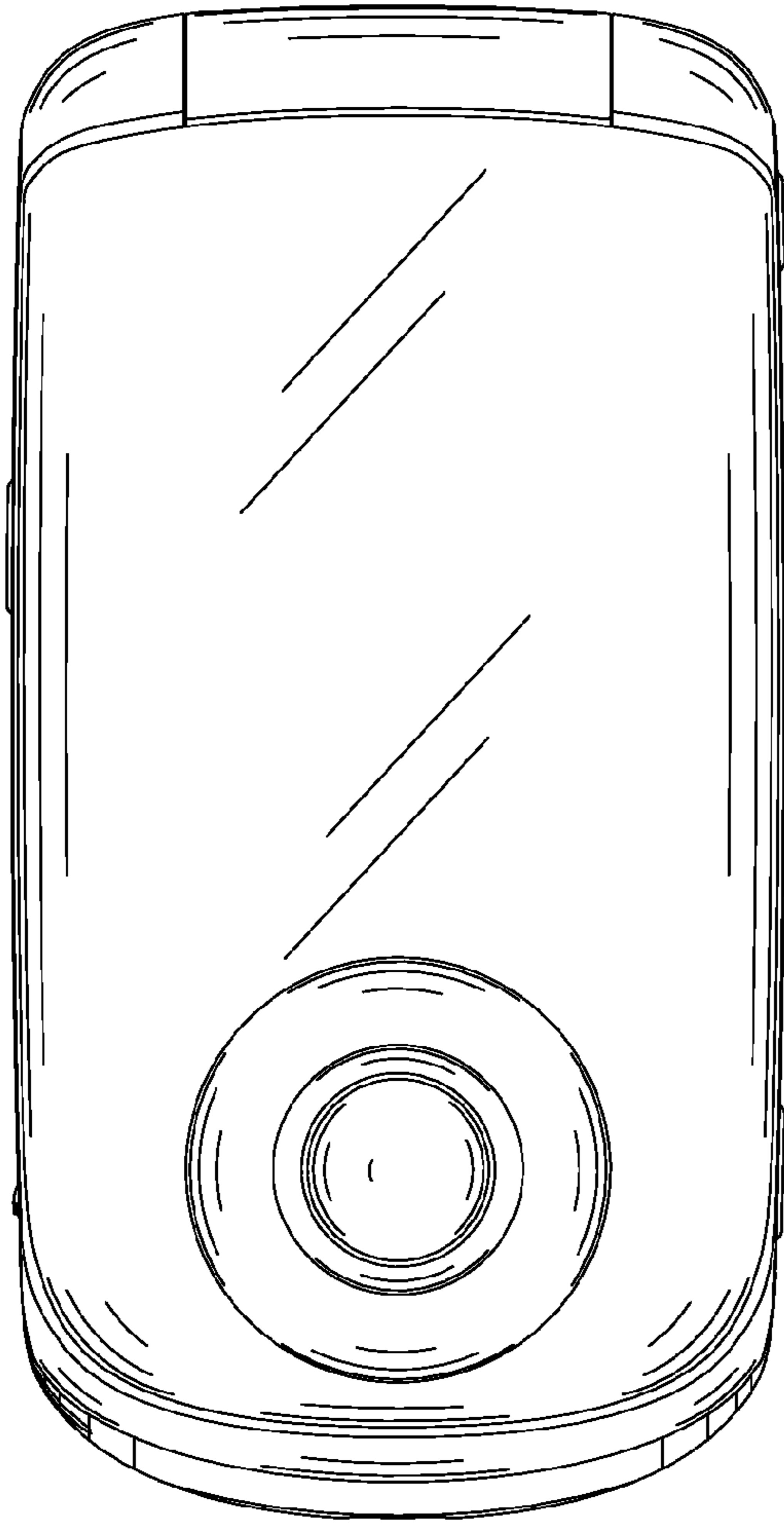

FIG. 27

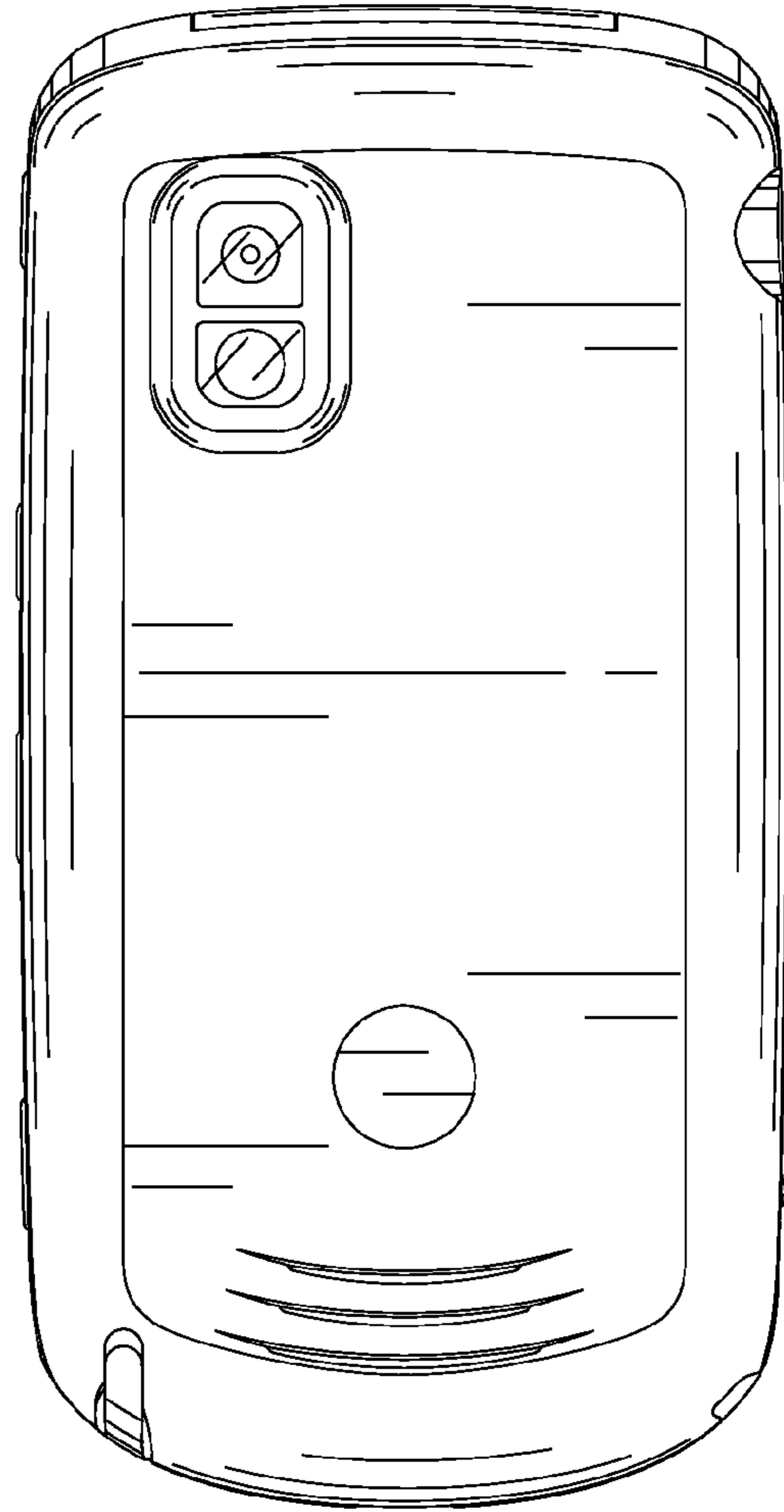

FIG. 28

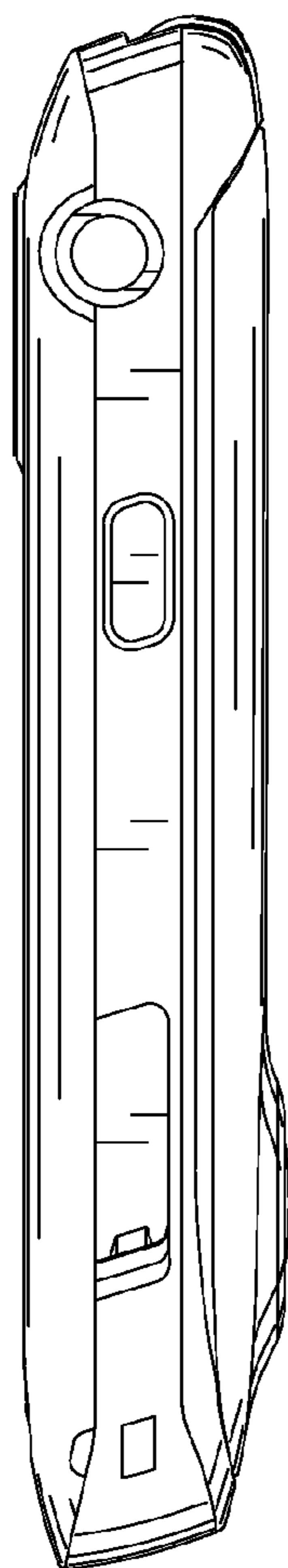

FIG. 29

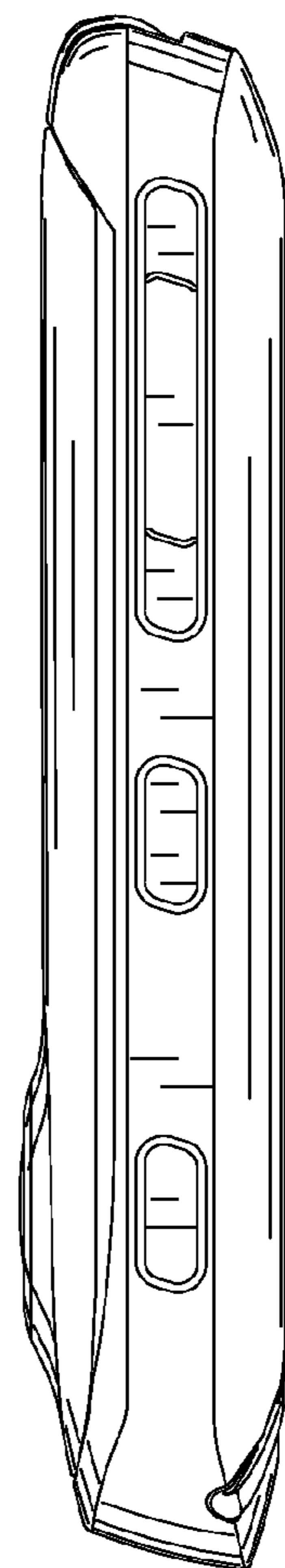

FIG. 30

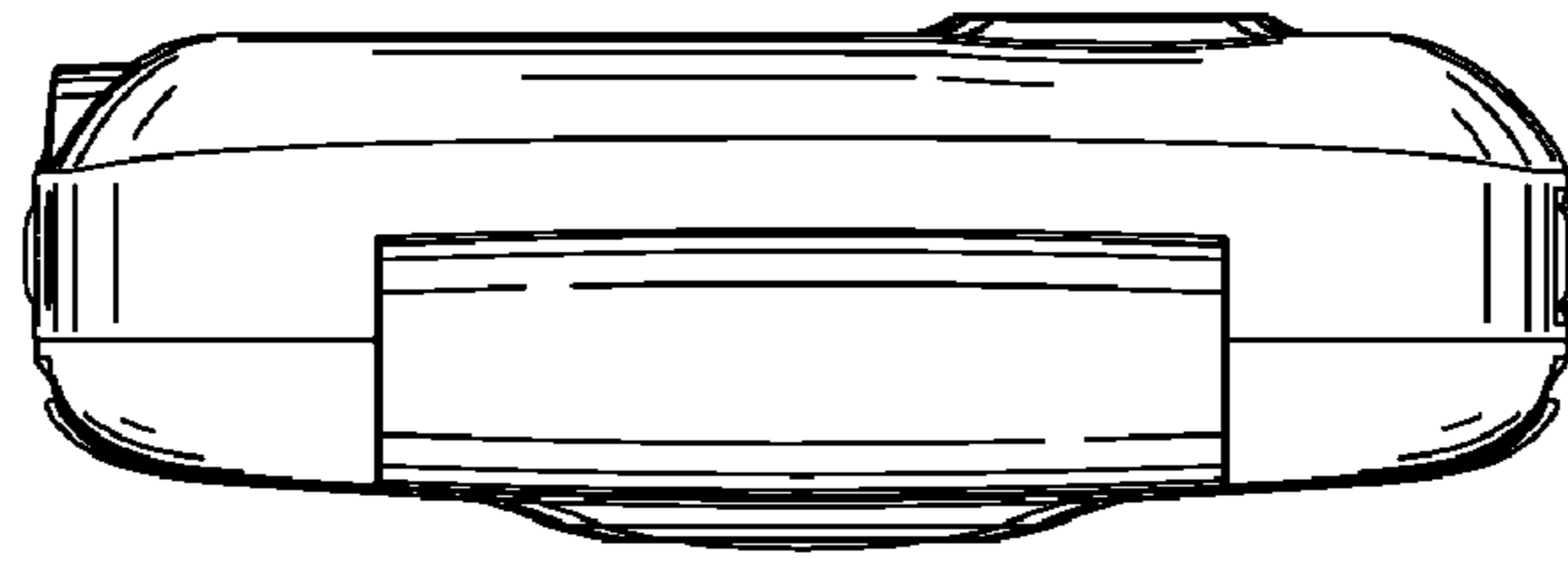

FIG. 31

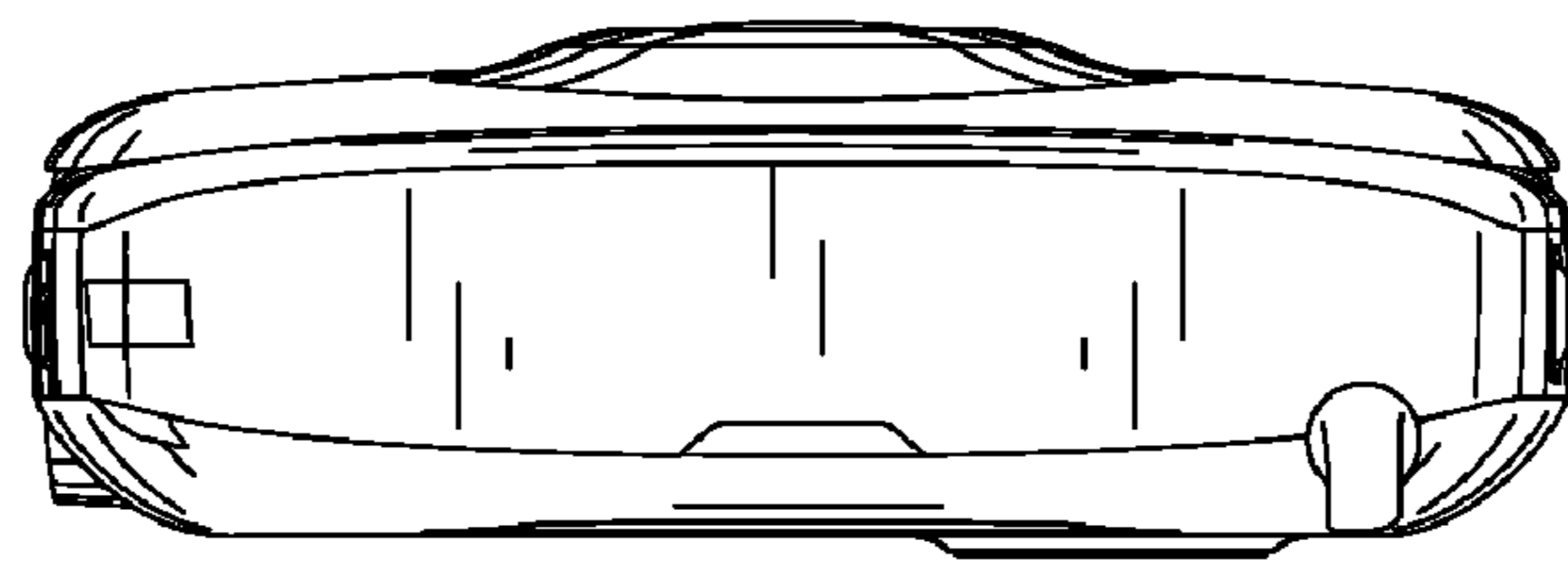

FIG. 32