



US00D631432S

(12) **United States Design Patent**
Miyazaki et al.

(10) **Patent No.:** **US D631,432 S**
(45) **Date of Patent:** **** Jan. 25, 2011**

(54) **SOLAR ARRAY**

(75) Inventors: **Yoshinori Miyazaki**, Aichi (JP); **Masao Hiramatsu**, Aichi (JP); **Masahito Fujita**, Aichi (JP); **Kouki Ozaki**, Aichi (JP)

(73) Assignee: **Daido Metal Company Ltd.** (JP)

(**) Term: **14 Years**

(21) Appl. No.: **29/375,908**

(22) Filed: **Sep. 29, 2010**

Related U.S. Application Data

(62) Division of application No. 29/357,065, filed on Mar. 5, 2010.

(30) **Foreign Application Priority Data**

Sep. 8, 2009	(JP)	2009-20721
Sep. 24, 2009	(JP)	2009-21872
Sep. 24, 2009	(JP)	2009-21873
Sep. 24, 2009	(JP)	2009-21874

(51) **LOC (9) Cl.** **13-02**

(52) **U.S. Cl.** **D13/102**

(58) **Field of Classification Search** D13/102,
D13/101, 184, 199; 52/173.3; 126/623,
126/624; 136/206, 244-251, 256, 291, 292
See application file for complete search history.

(56) **References Cited**

U.S. PATENT DOCUMENTS

4,063,963 A * 12/1977 Bond, Jr. 136/244

(Continued)

Primary Examiner—Prabhakar Deshmukh

Assistant Examiner—Derrick Holland

(74) *Attorney, Agent, or Firm*—SAIDMAN DesignLaw Group

(57) **CLAIM**

The ornamental design for a solar array, as shown and described.

DESCRIPTION

FIG. 1 is a perspective view of a solar array in a first position;
 FIG. 2 is a top view thereof;
 FIG. 3 is a bottom view thereof;
 FIG. 4 is a front view thereof;
 FIG. 5 is a rear view thereof;
 FIG. 6 is a left side view thereof;
 FIG. 7 is a right side view thereof;
 FIG. 8 is a perspective view, showing the solar array in a second position;
 FIG. 9 is a top view thereof;
 FIG. 10 is a bottom view thereof;
 FIG. 11 is a front view thereof;
 FIG. 12 is a rear view thereof;
 FIG. 13 is a left side view thereof;
 FIG. 14 is a right side view thereof;
 FIG. 15 is a perspective view, showing the solar array in a third position;
 FIG. 16 is a top view thereof;
 FIG. 17 is a bottom view thereof;
 FIG. 18 is a front view thereof;
 FIG. 19 is a rear view thereof;
 FIG. 20 is a left side view thereof;
 FIG. 21 is a right side view thereof;
 FIG. 22 is a perspective view, showing the solar array in a fourth position;
 FIG. 23 is a front view thereof, the rear, left side, and right side views being identical thereto;
 FIG. 24 is a top view thereof; and,
 FIG. 25 is a bottom view thereof.

The illustrated positions of the solar array of our design are understood to be exemplary of possible alternate positions.

1 Claim, 9 Drawing Sheets

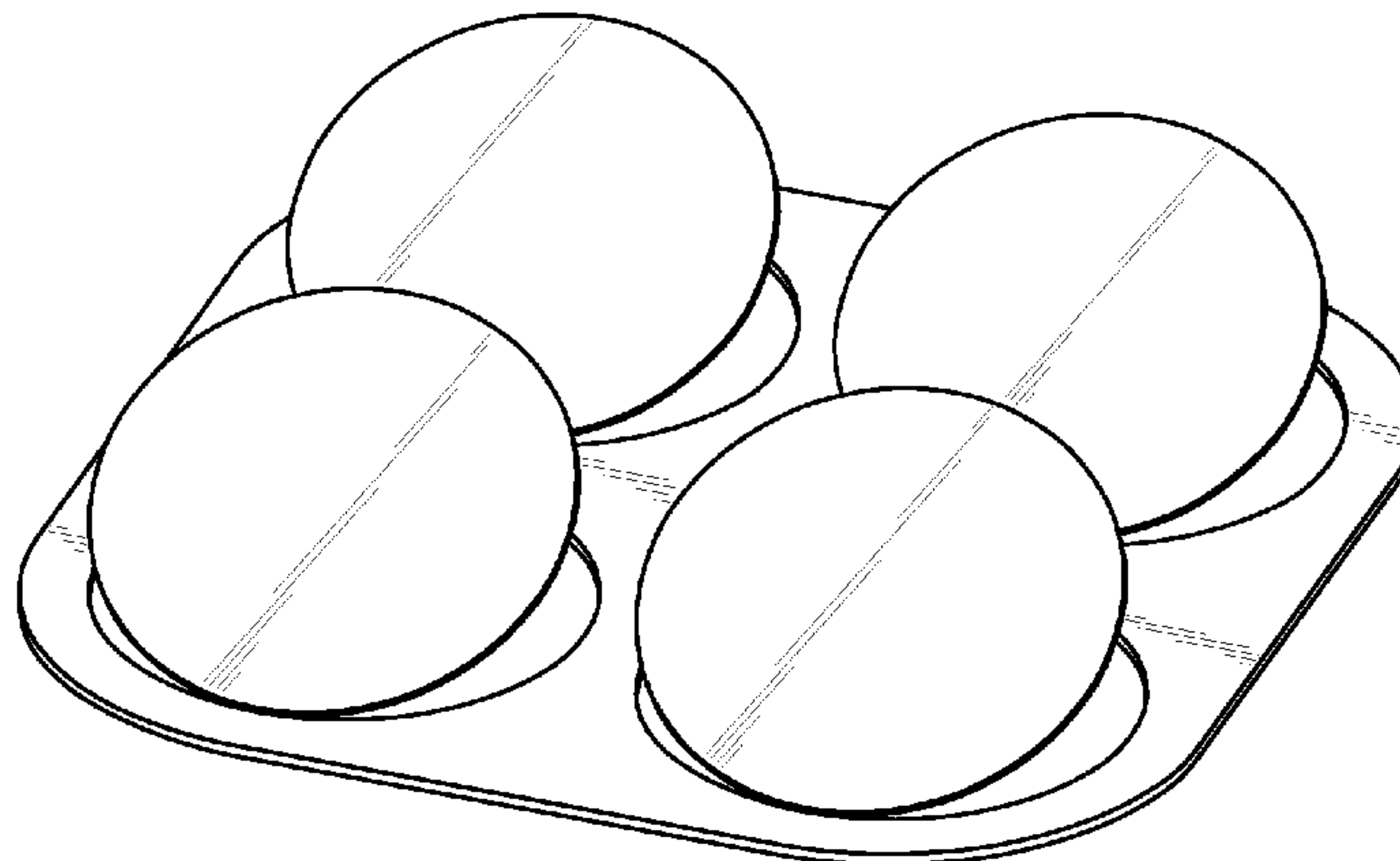

US D631,432 S

Page 2

U.S. PATENT DOCUMENTS

D262,307 S *	12/1981	Parlato	D13/102	D555,083 S *	11/2007	Sharma et al.	D13/102
4,474,172 A *	10/1984	Burke	126/598	D555,084 S *	11/2007	Sharma et al.	D13/102
4,565,185 A *	1/1986	Mori	126/577	D564,443 S *	3/2008	Moore	D13/102
D303,244 S *	9/1989	Hanak	D13/102	D577,332 S *	9/2008	Moore	D13/102
D468,684 S *	1/2003	Shugar	D13/102	2008/0168981 A1 *	7/2008	Cummings et al.	126/600

* cited by examiner

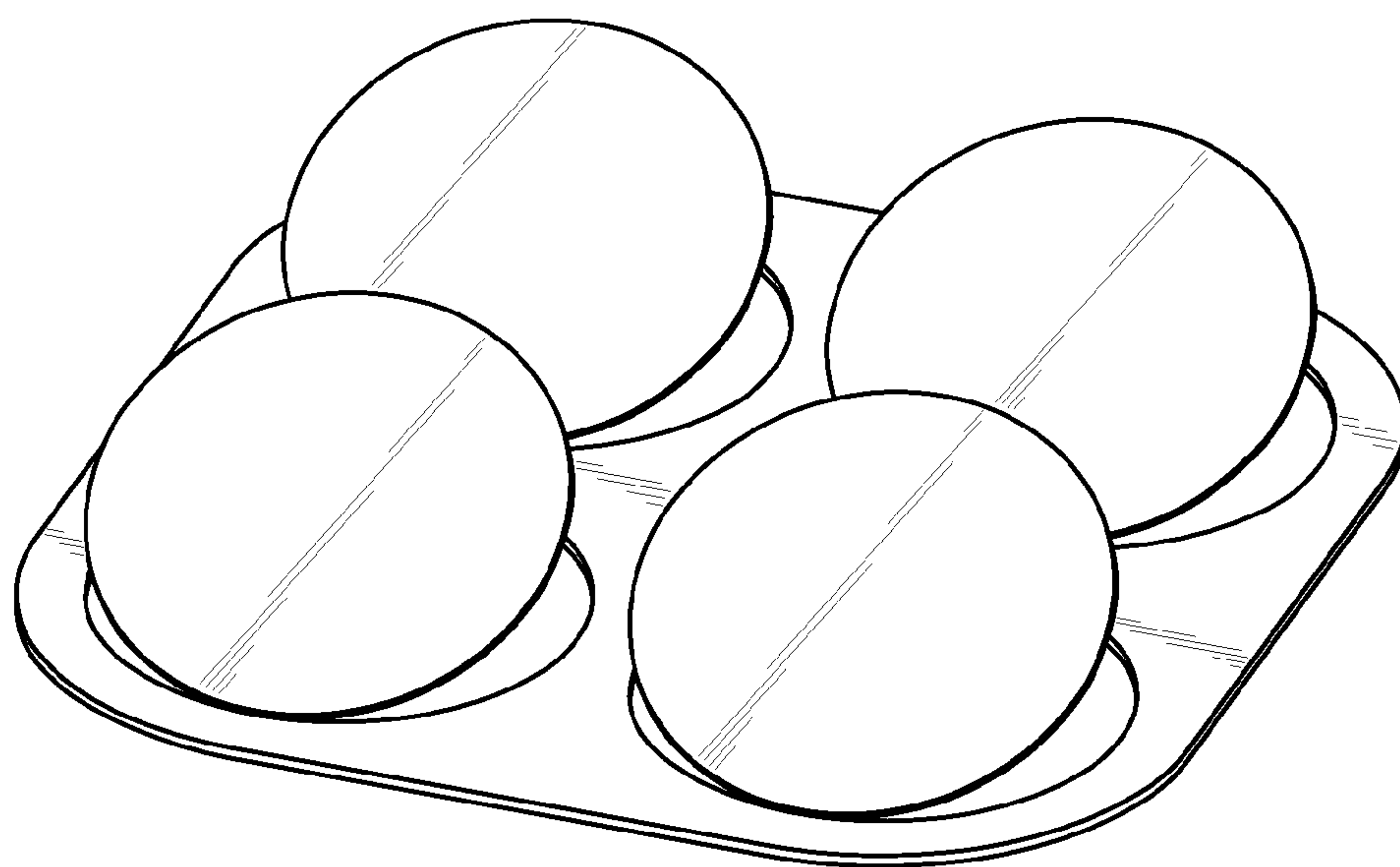

Fig. 1

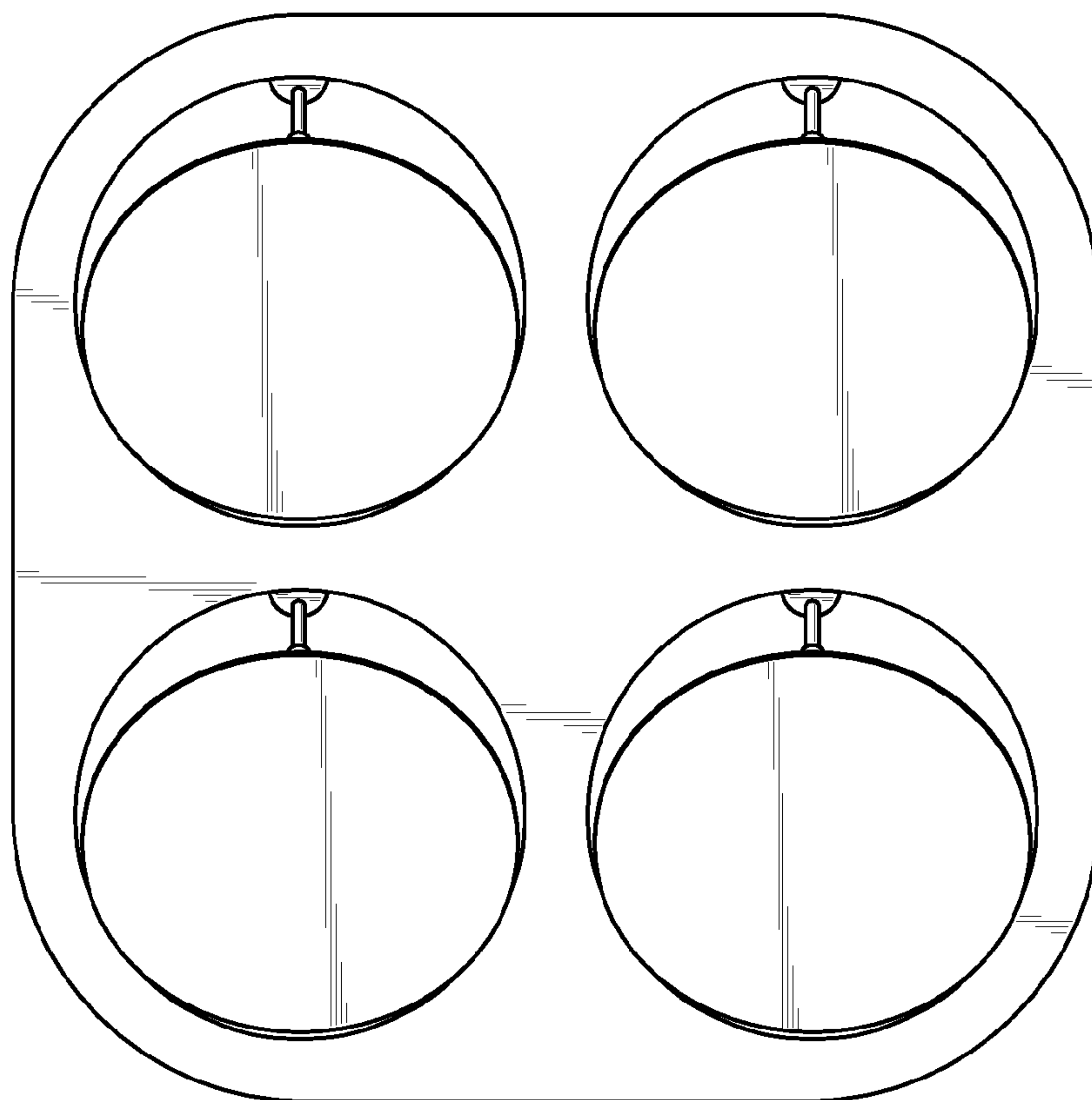

Fig. 2

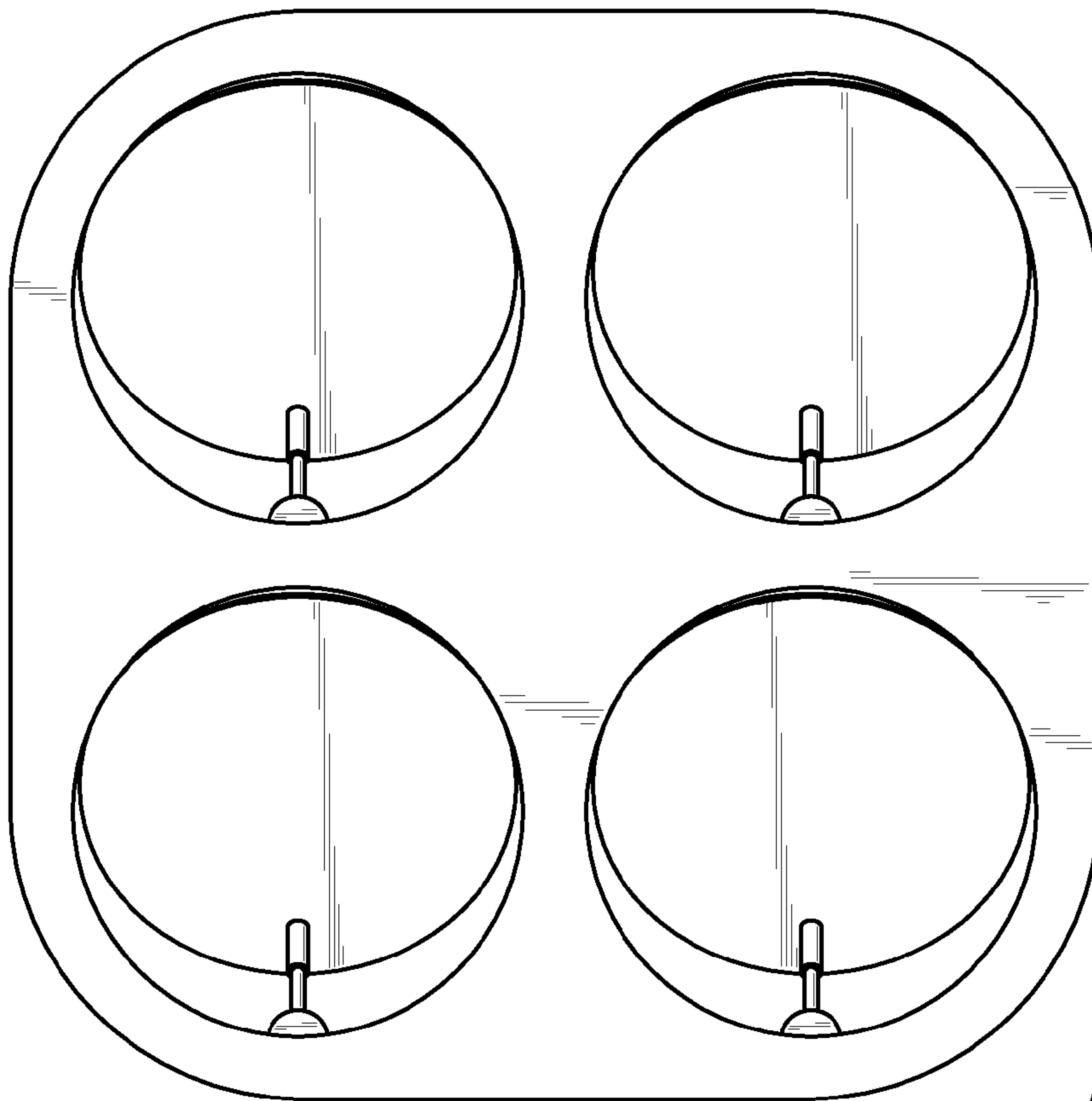

Fig. 3

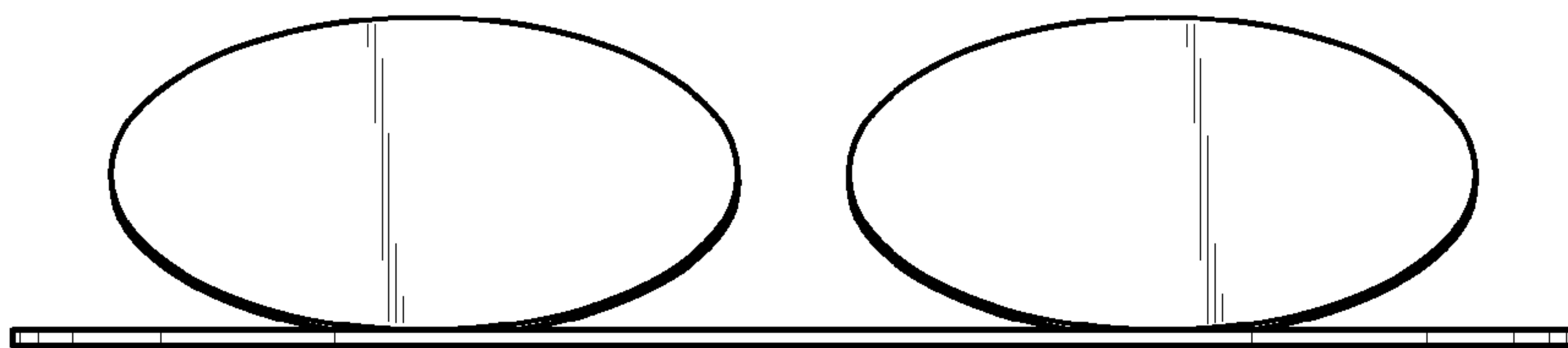

Fig. 4

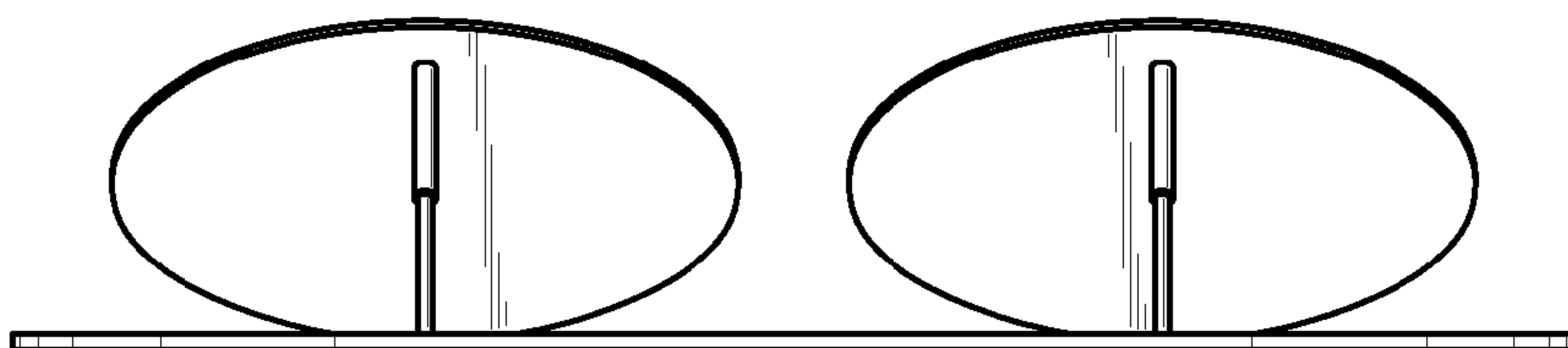

Fig. 5

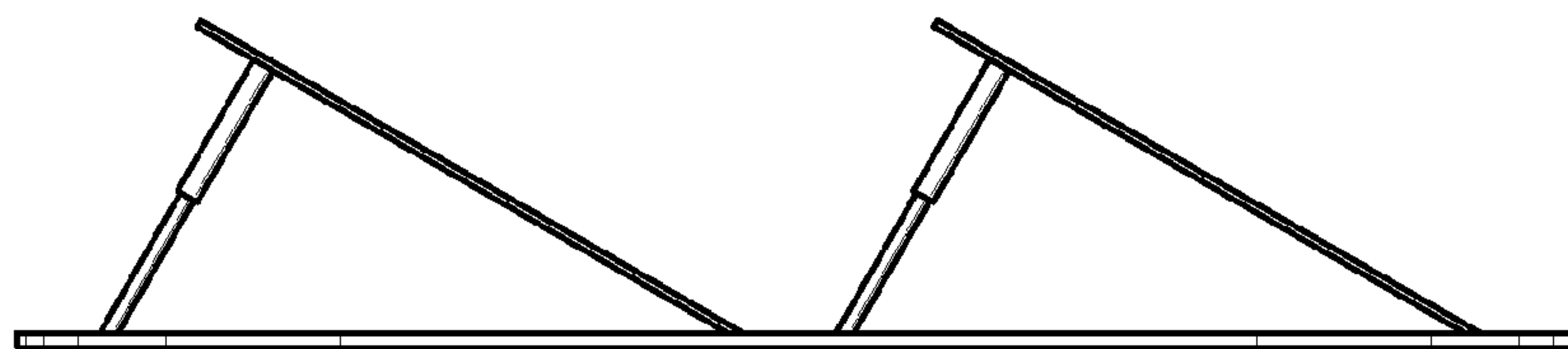

Fig. 6

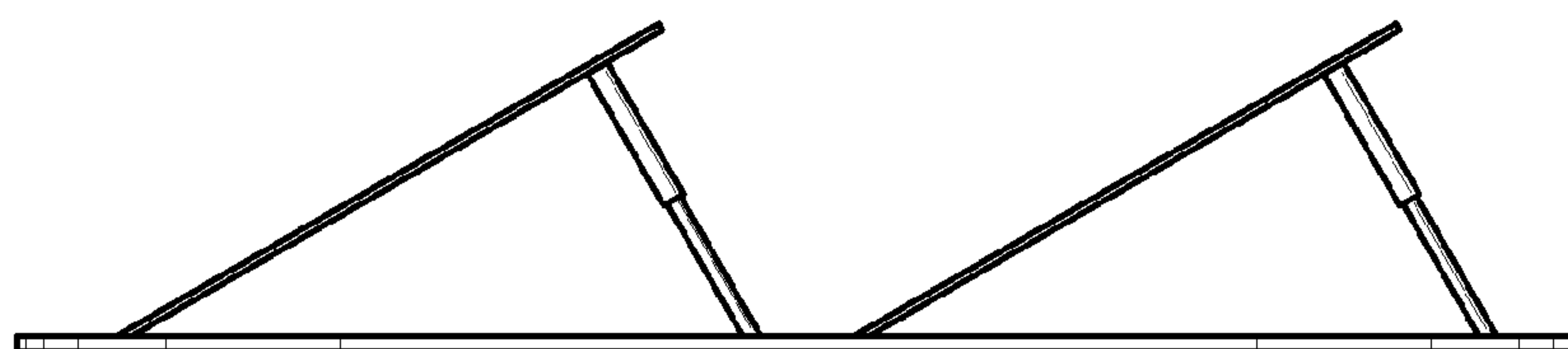

Fig. 7

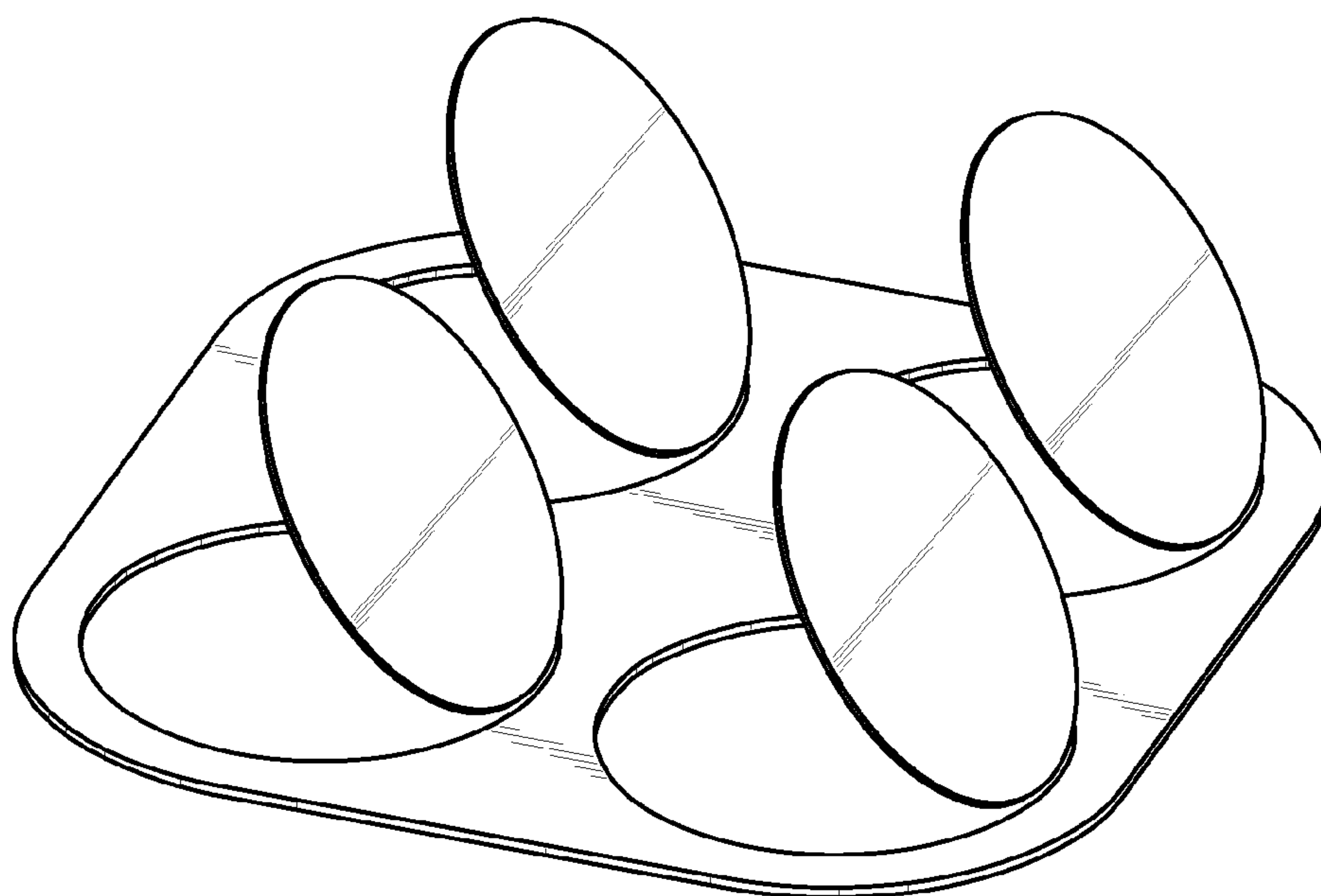

Fig. 8

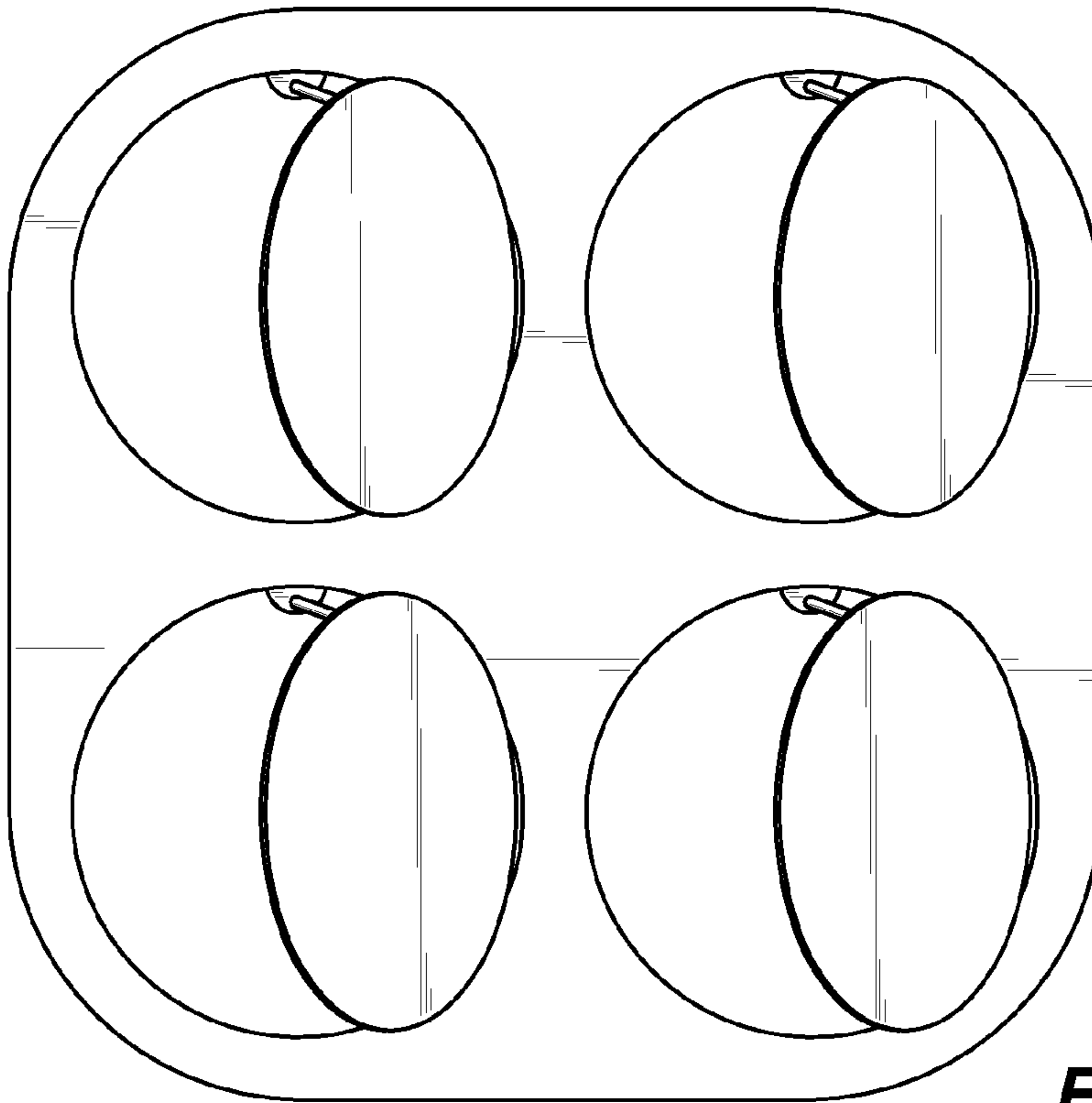

Fig. 9

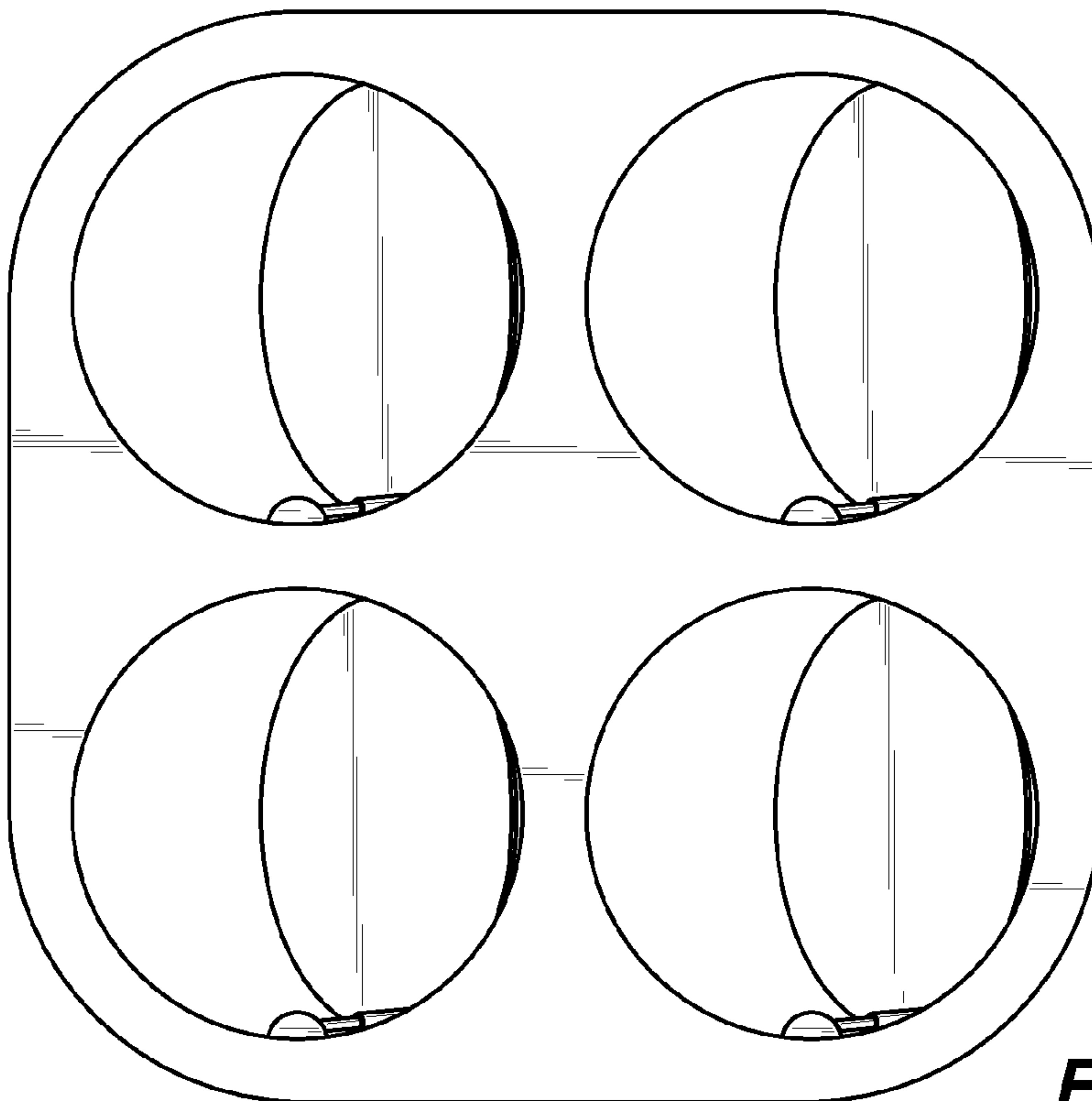

Fig. 10

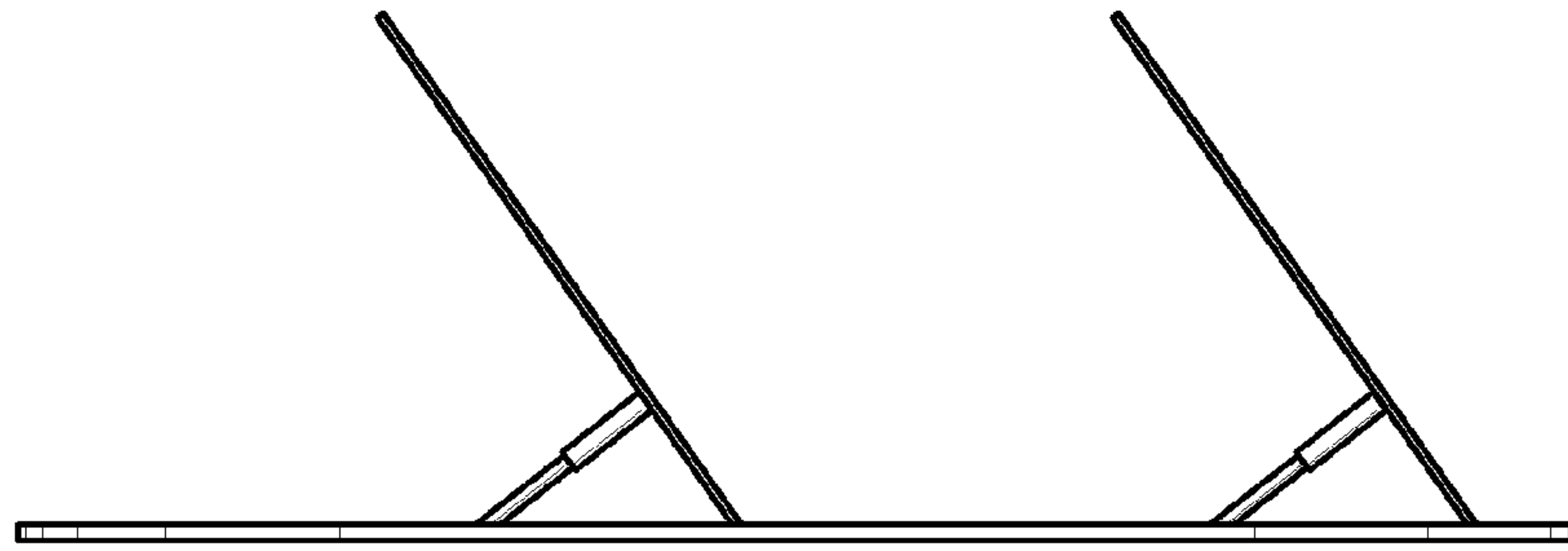

Fig. 11

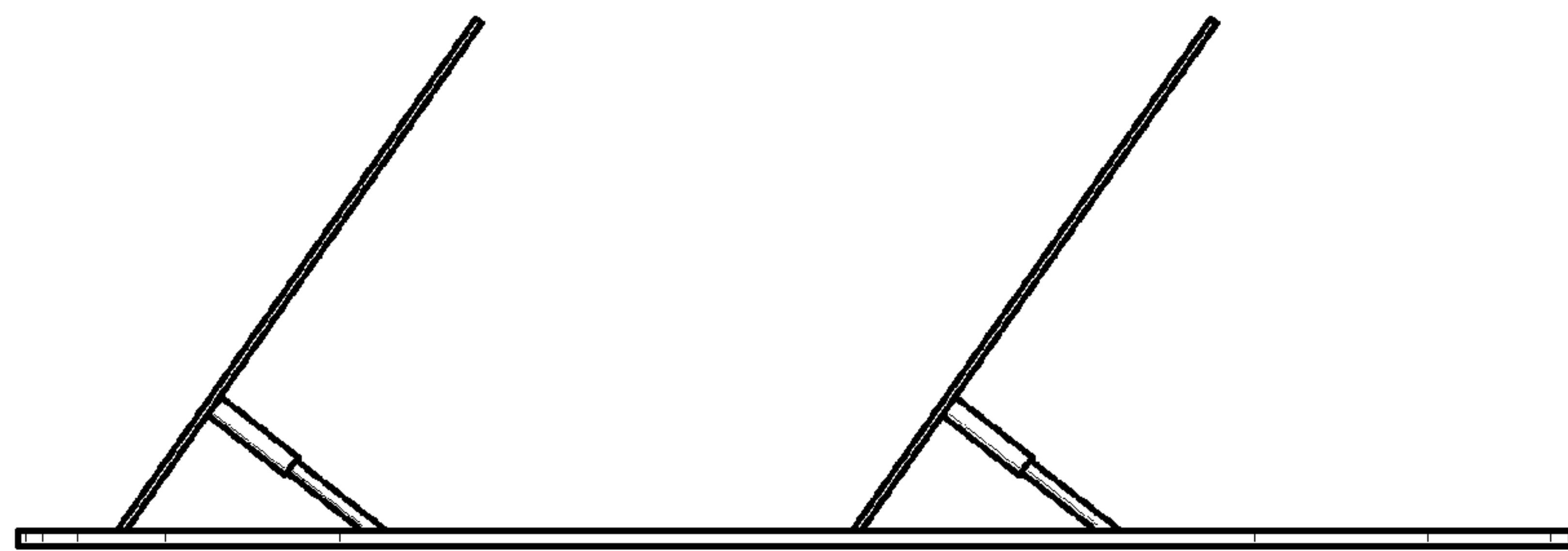

Fig. 12

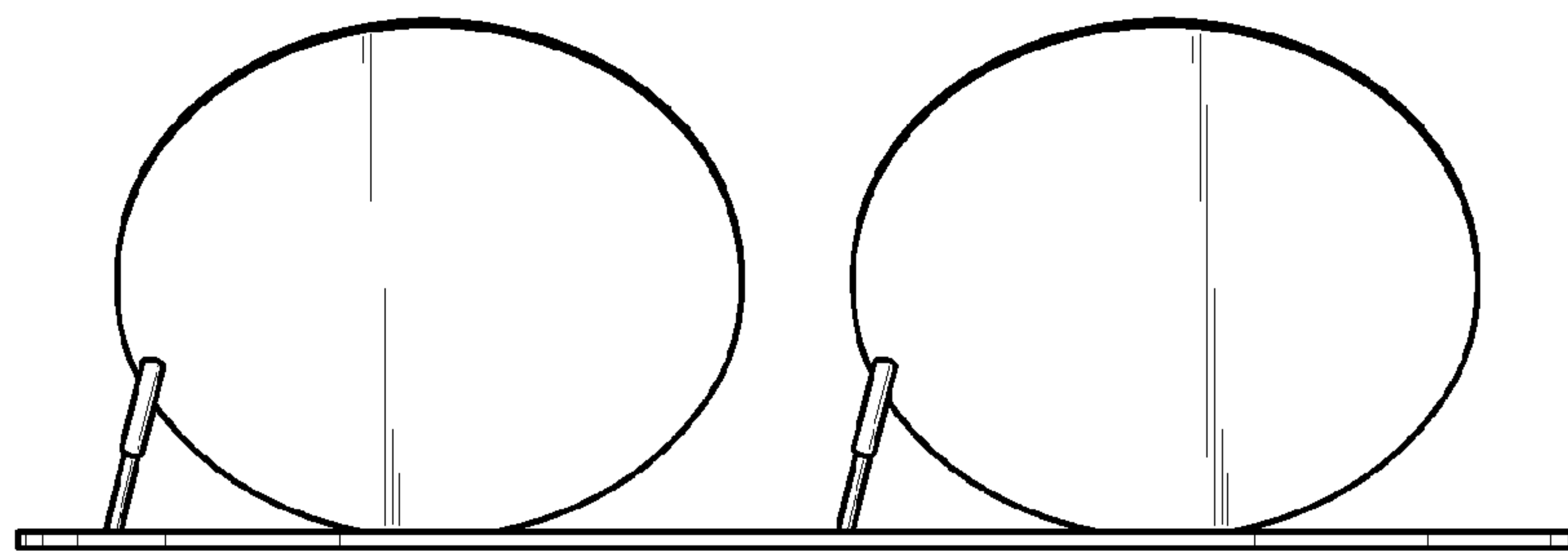

Fig. 13

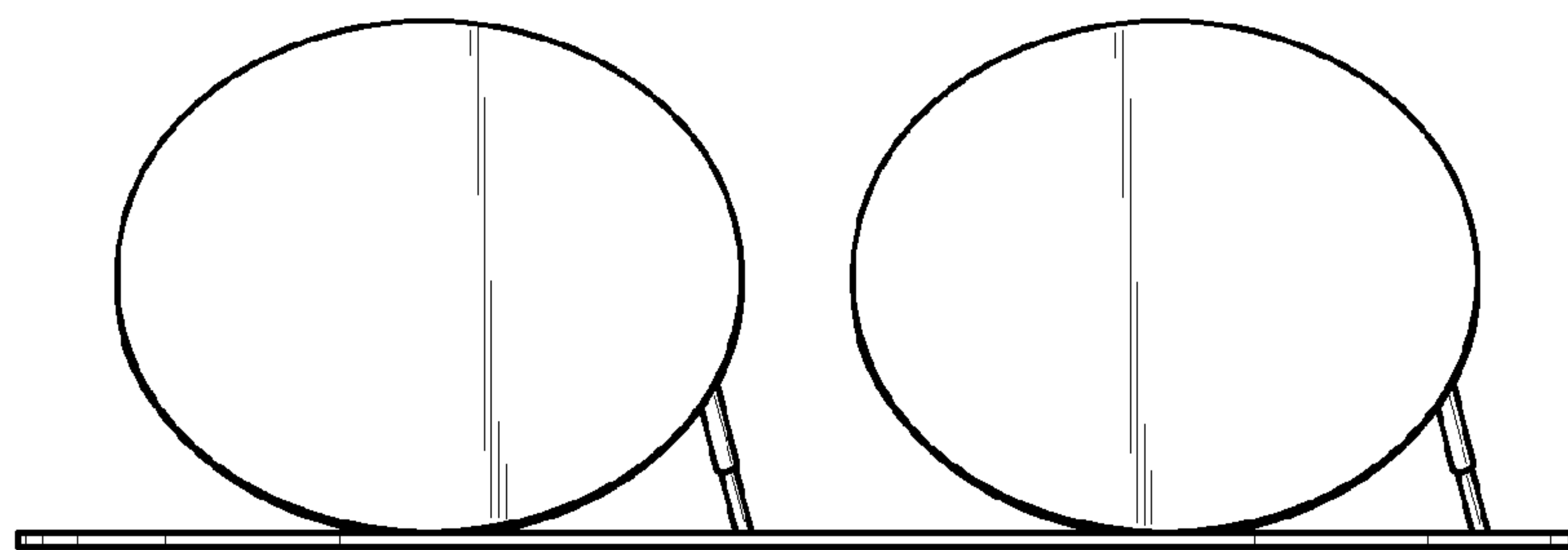

Fig. 14

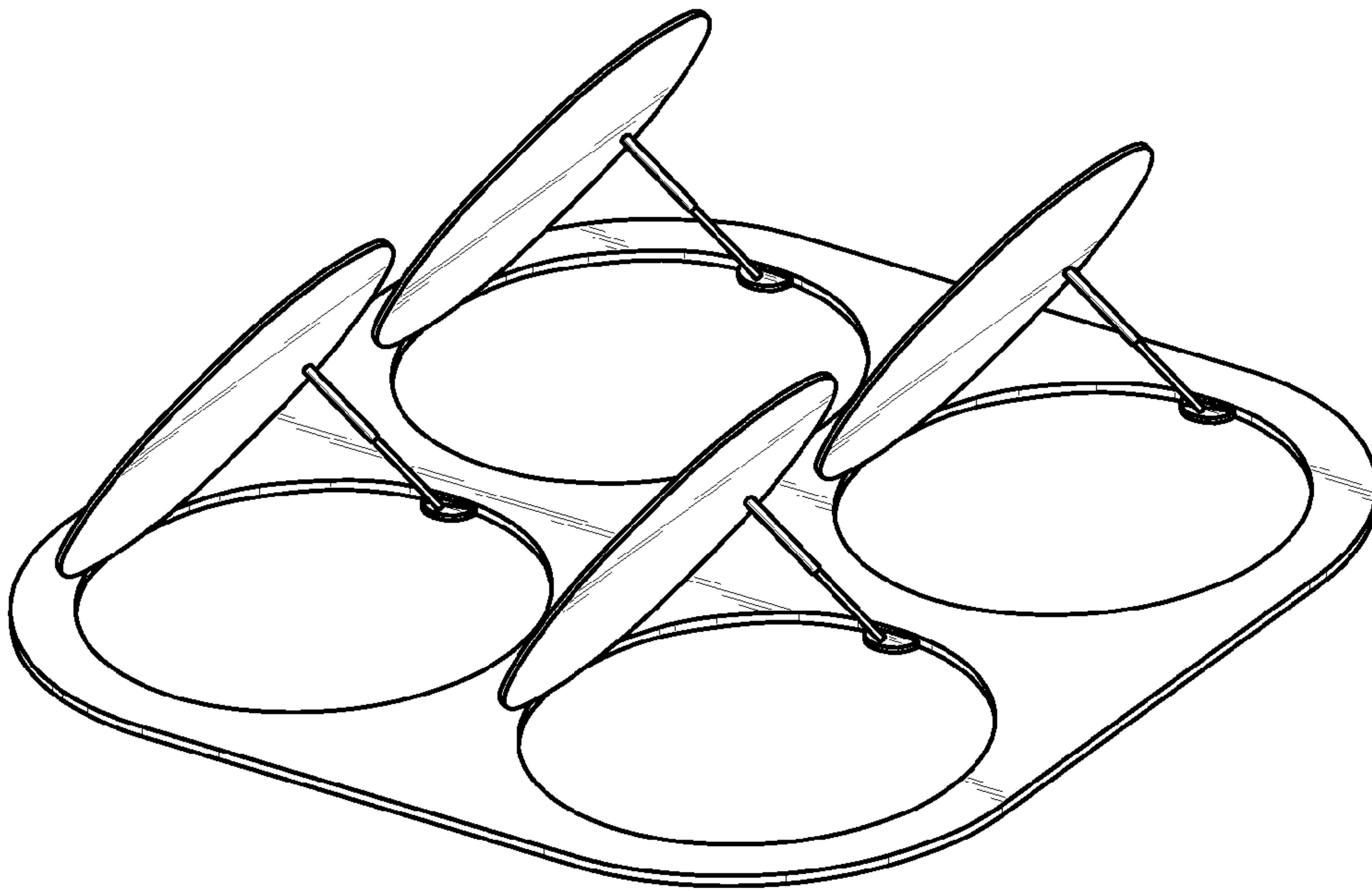

Fig. 15

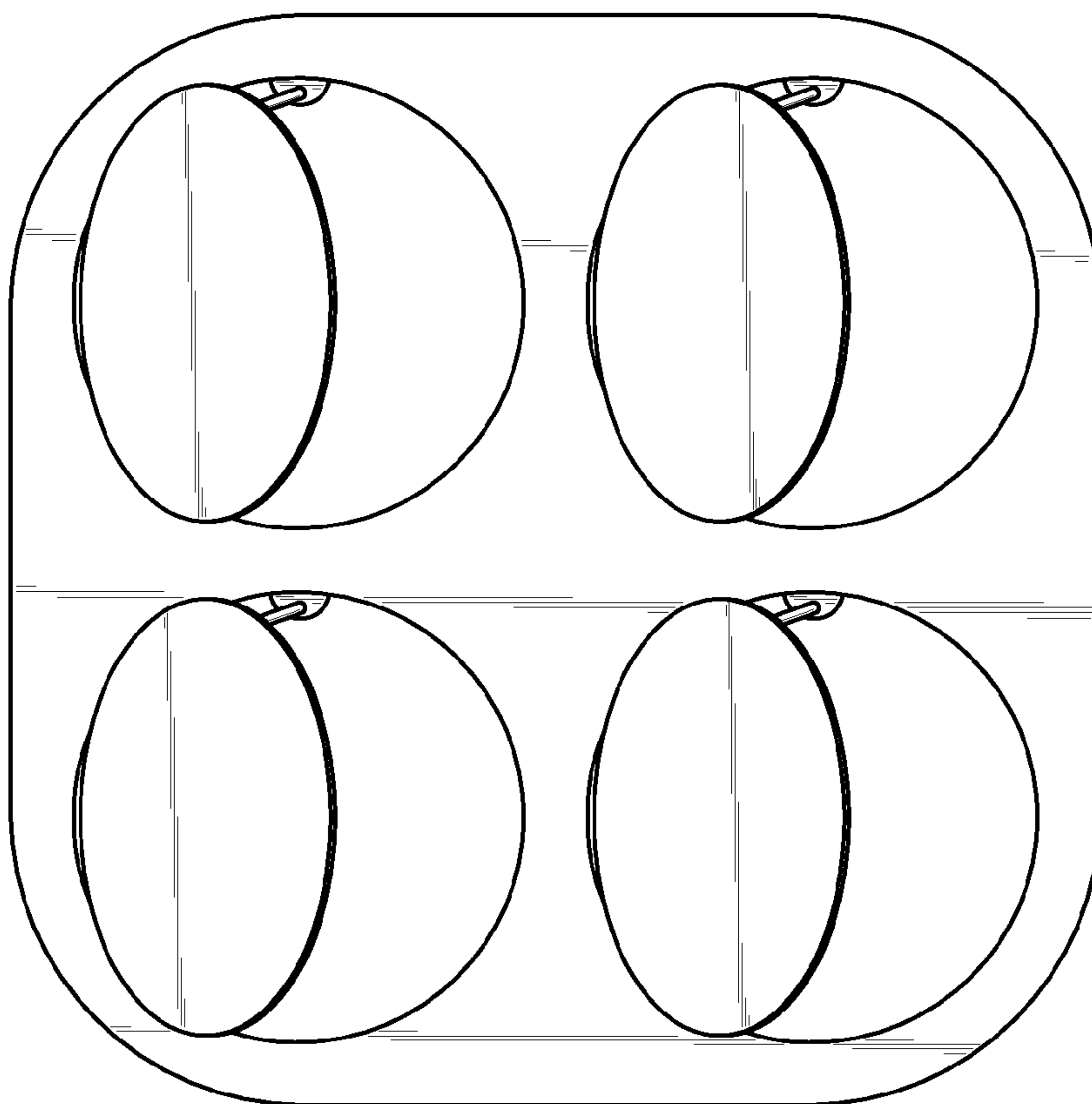

Fig. 16

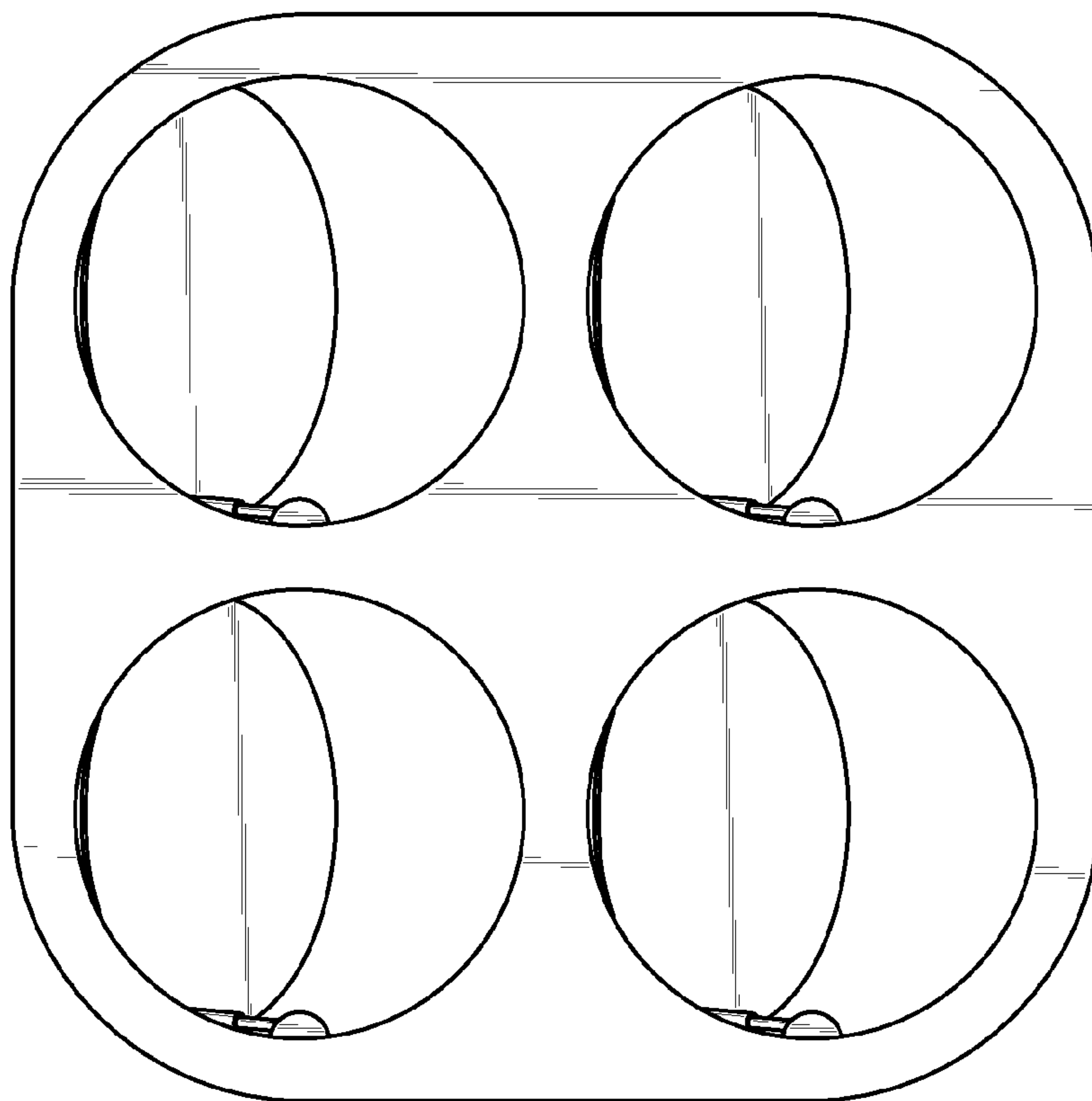

Fig. 17

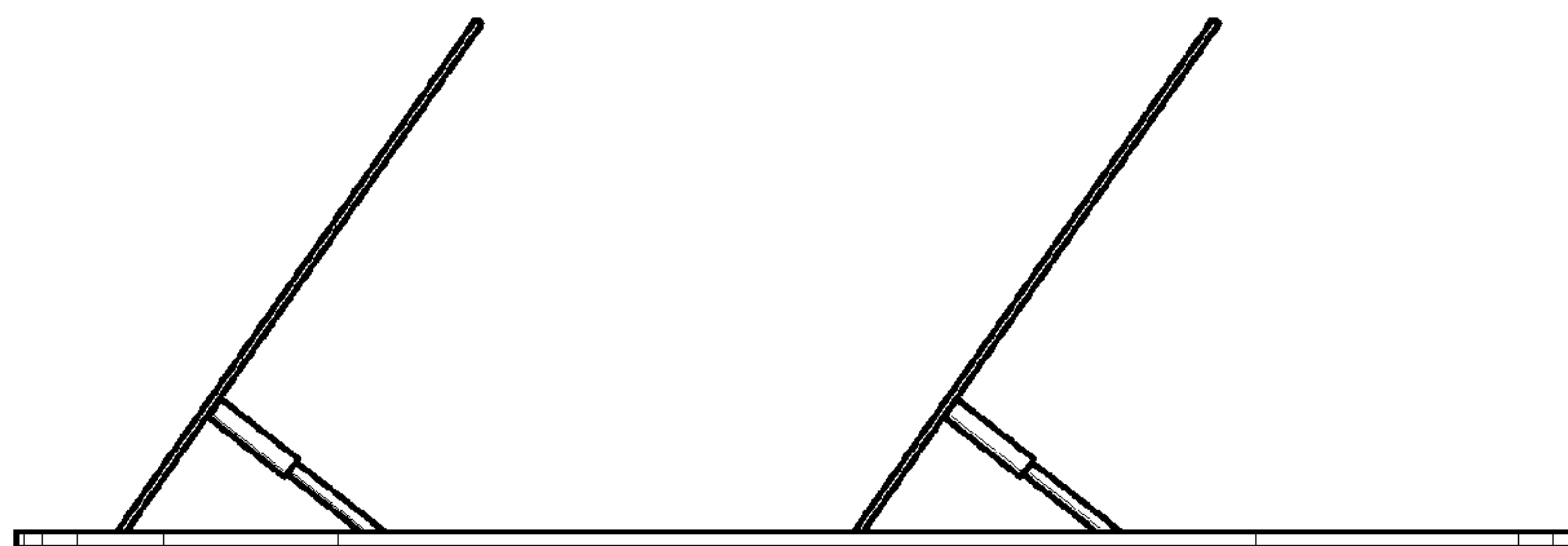

Fig. 18

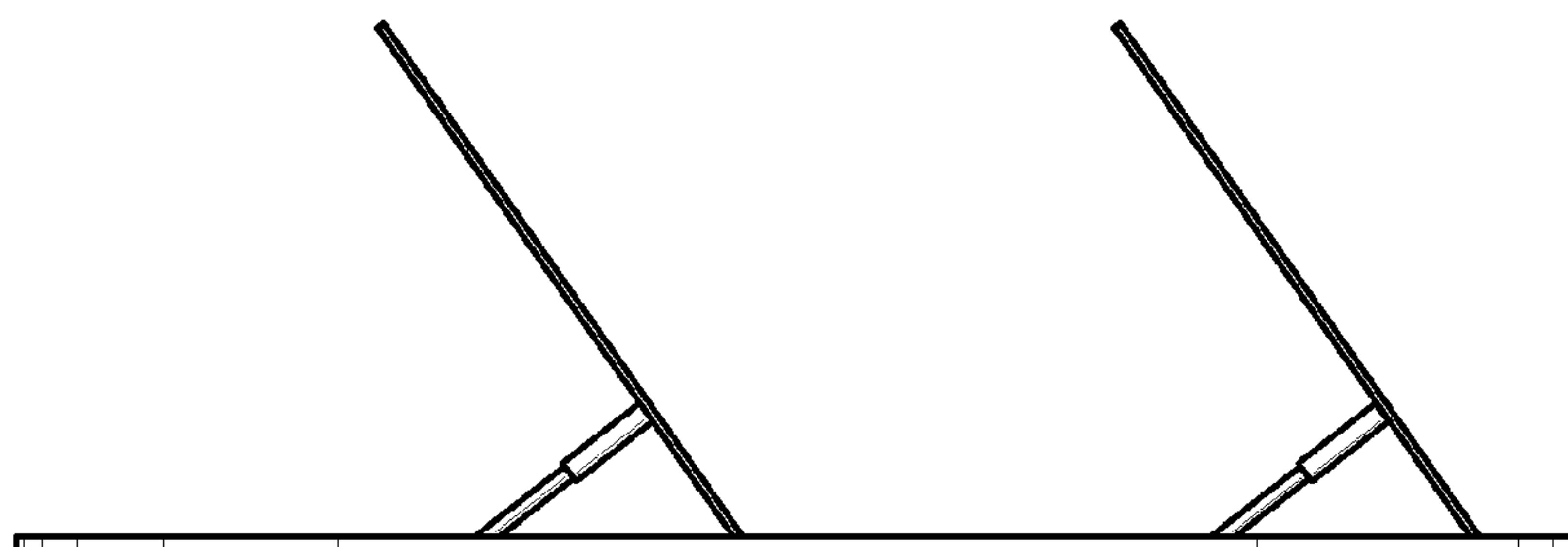

Fig. 19

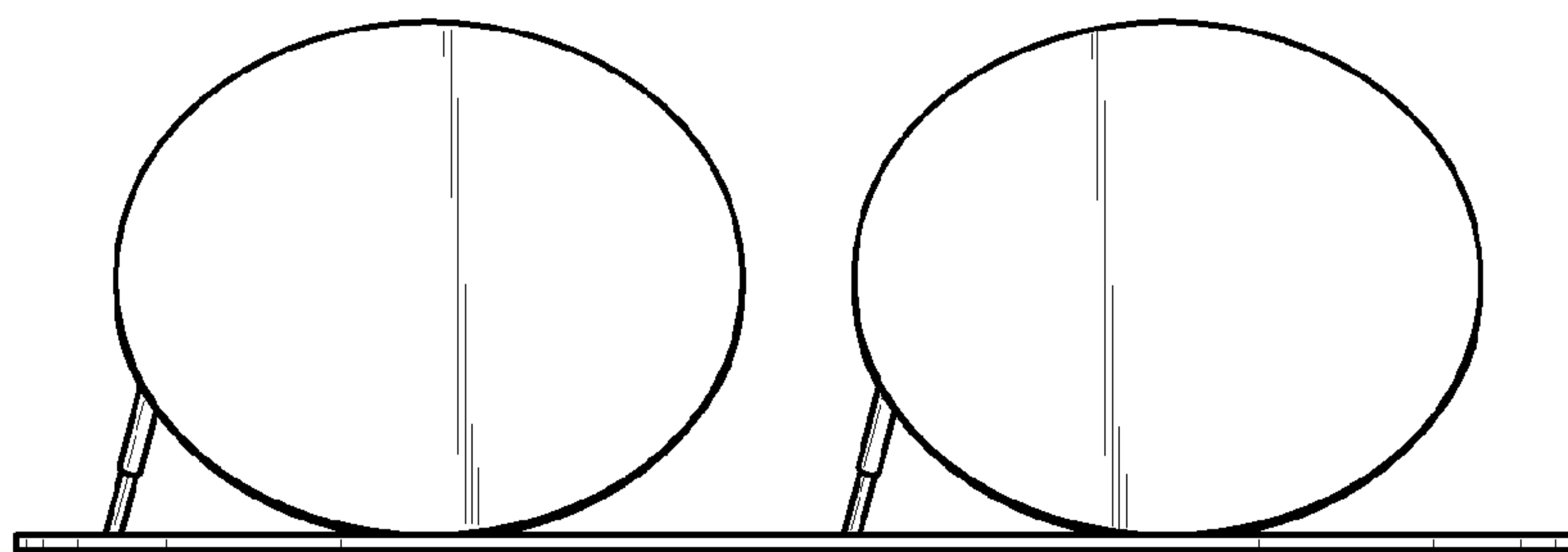

Fig. 20

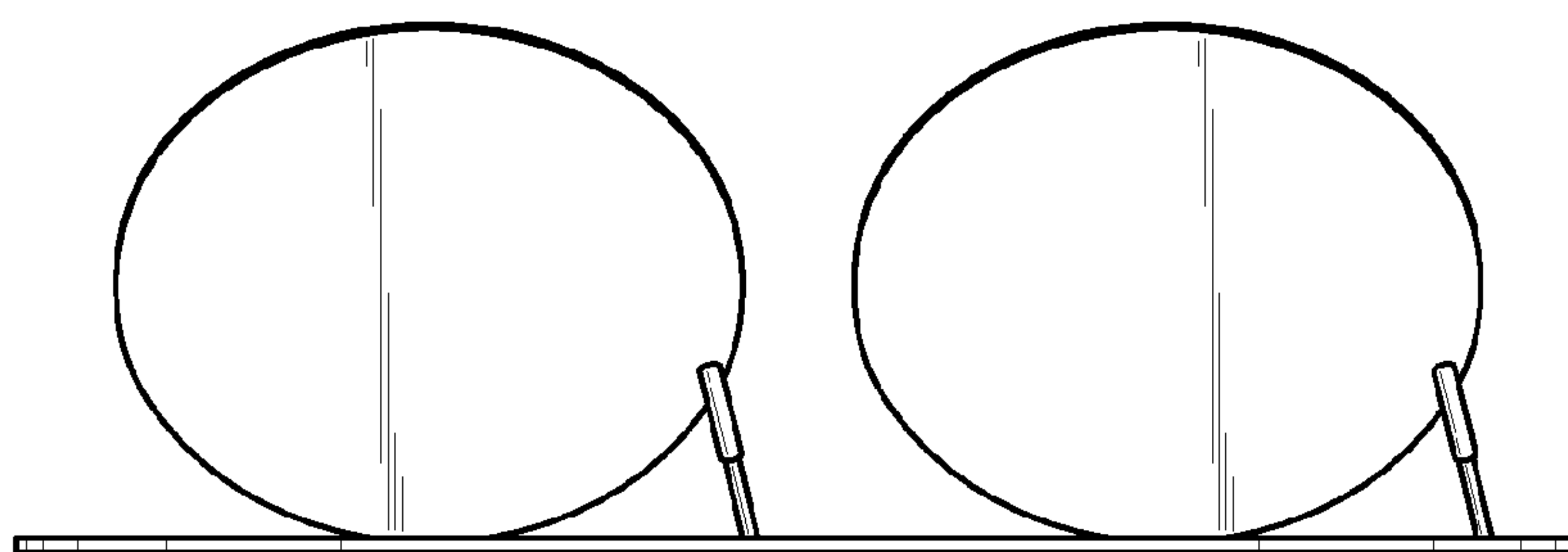

Fig. 21

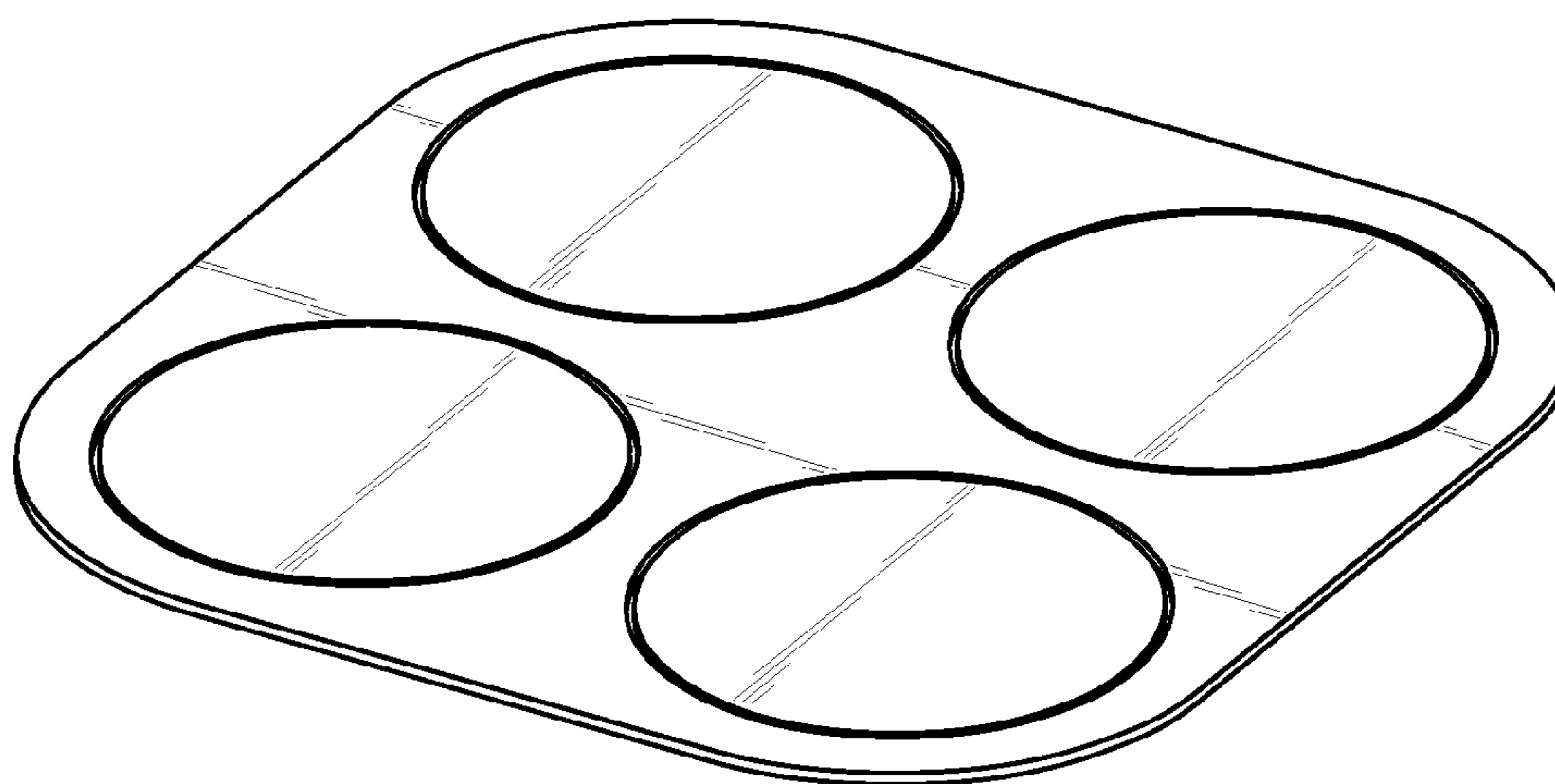

Fig. 22



Fig. 23

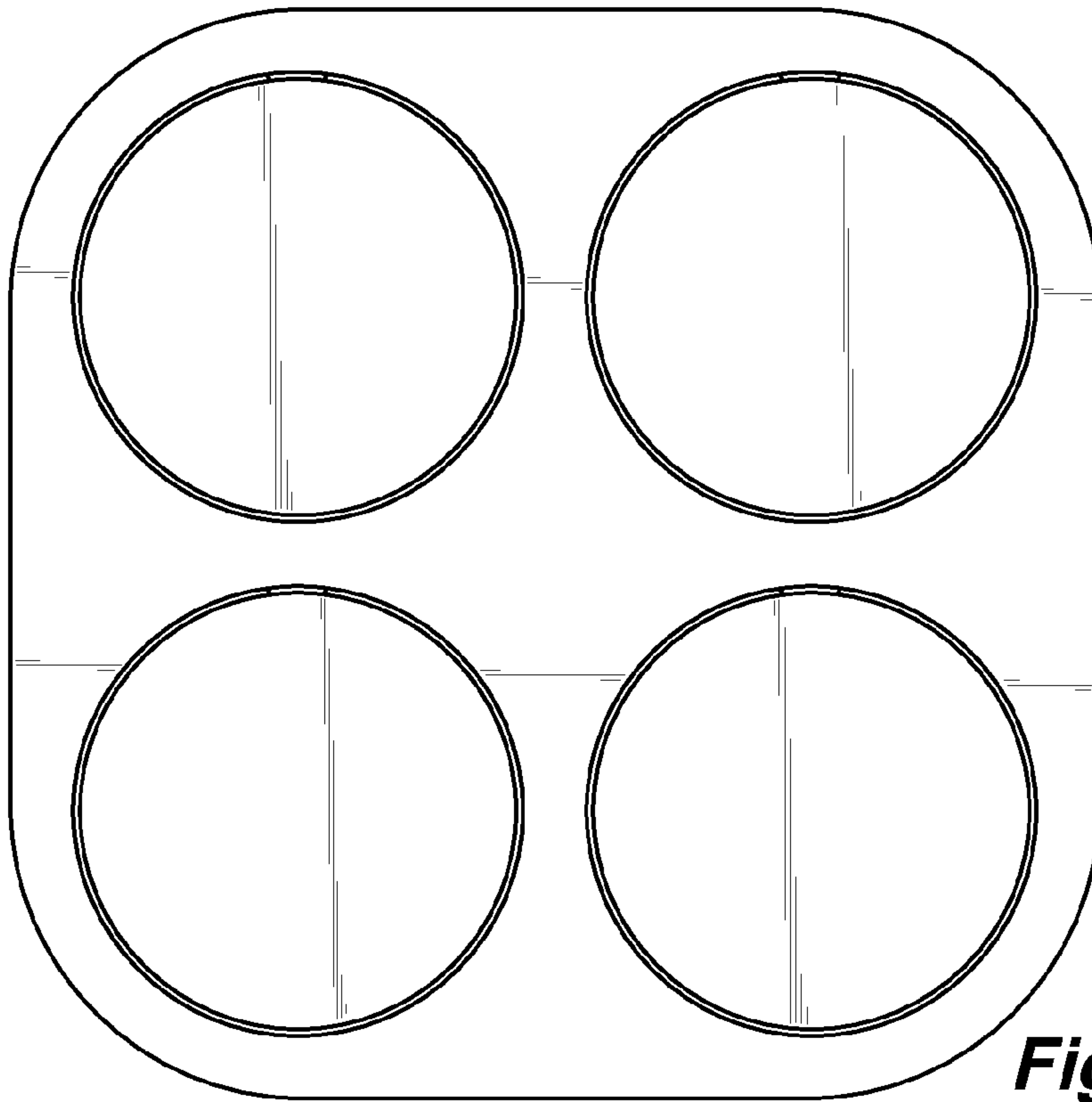

Fig. 24

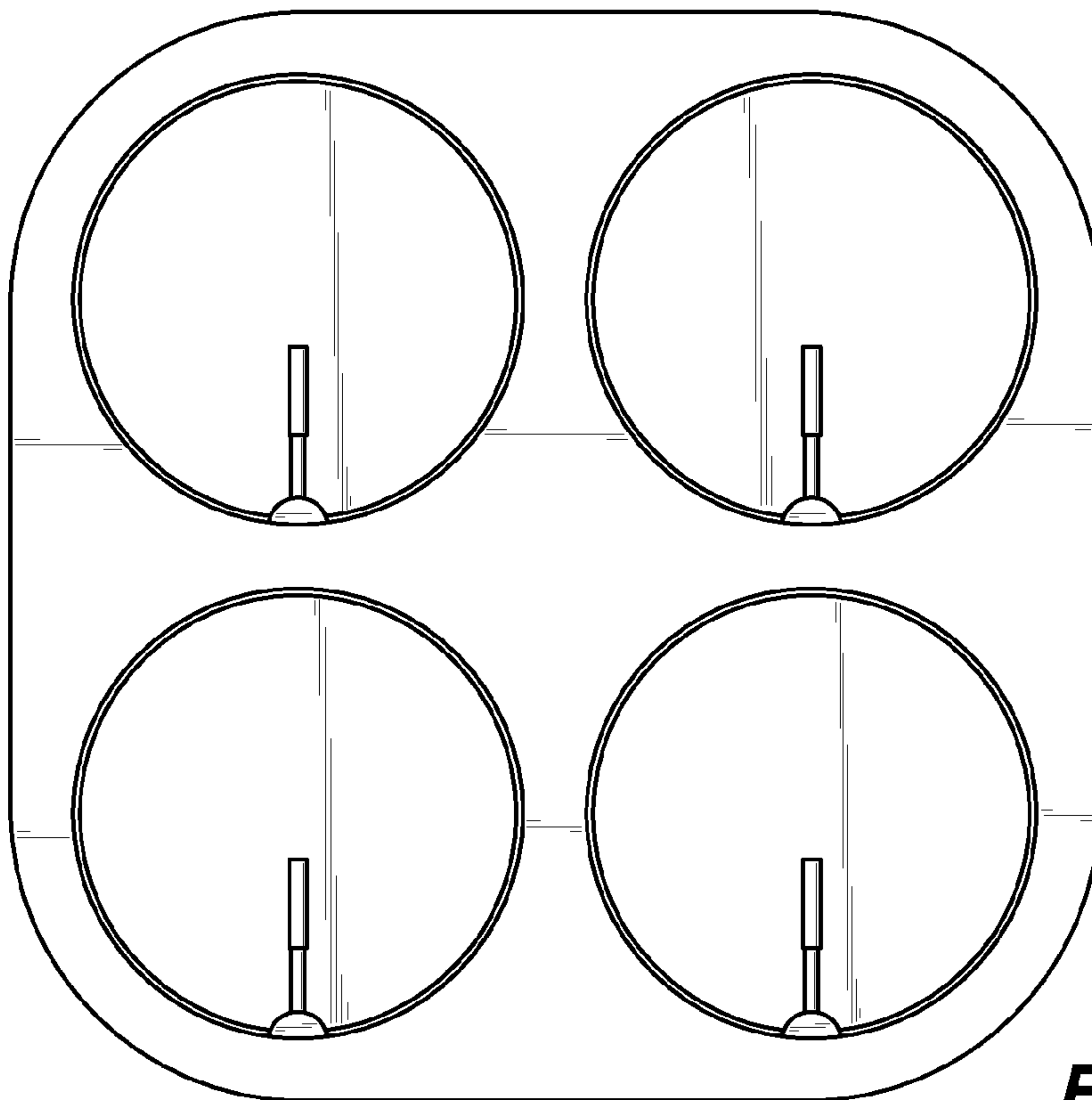

Fig. 25