



US00D631404S

(12) **United States Design Patent**
Hodges

(10) **Patent No.:** **US D631,404 S**

(45) **Date of Patent:** **** *Jan. 25, 2011**

(54) **AUTOMOTIVE GRILLE**

(76) **Inventor:** **Frank J. Hodges**, 20624 Mirkwood Run, Yorba Linda, CA (US) 92886

(**) **Term:** **14 Years**

(21) **Appl. No.:** **29/345,993**

(22) **Filed:** **Oct. 23, 2009**

(51) **LOC (9) Cl.** **12-16**

(52) **U.S. Cl.** **D12/163**

(58) **Field of Classification Search** D12/163,
D12/196, 171, 169, 216, 90-92, 86; 180/68.1,
180/68.6; 296/193.11

See application file for complete search history.

(56) **References Cited**

U.S. PATENT DOCUMENTS

D488,111 S *	4/2004	Elwell	D12/163
D546,247 S *	7/2007	Abbett	D12/163
D570,264 S *	6/2008	Spry	D12/171
D613,211 S *	4/2010	Wu	D12/163
D613,212 S *	4/2010	Wu	D12/163

OTHER PUBLICATIONS

Truck grilles from at least as early as Oct. 22, 2008 in 3 pages downloaded from www.rollingbigpower.com.

* cited by examiner

Primary Examiner—Melody N Brown

(74) *Attorney, Agent, or Firm*—Knobbe, Martens, Olson & Bear, LLP

(57) **CLAIM**

The ornamental design for an automotive grille, as shown and described.

DESCRIPTION

FIG. 1 is a front view of an automotive grille showing an embodiment of my new design;

FIG. 2 is a rear view thereof;

FIG. 3 is a top view thereof;

FIG. 4 is a bottom view thereof;

FIG. 5 is a left-side view thereof;

FIG. 6 is a right-side view thereof;

FIG. 7 is a perspective view thereof;

FIG. 8 is a front view of an automotive grille showing a second embodiment of my new design;

FIG. 9 is a rear view of FIG. 8;

FIG. 10 is a top view of FIG. 8;

FIG. 11 is a bottom view of FIG. 8;

FIG. 12 is a left-side view of FIG. 8;

FIG. 13 is a right-side view of FIG. 8; and,

FIG. 14 is a perspective view of FIG. 8.

The portions shown in phantom provide context only but do not limit the claim and should not be considered part of the claimed design.

1 Claim, 6 Drawing Sheets

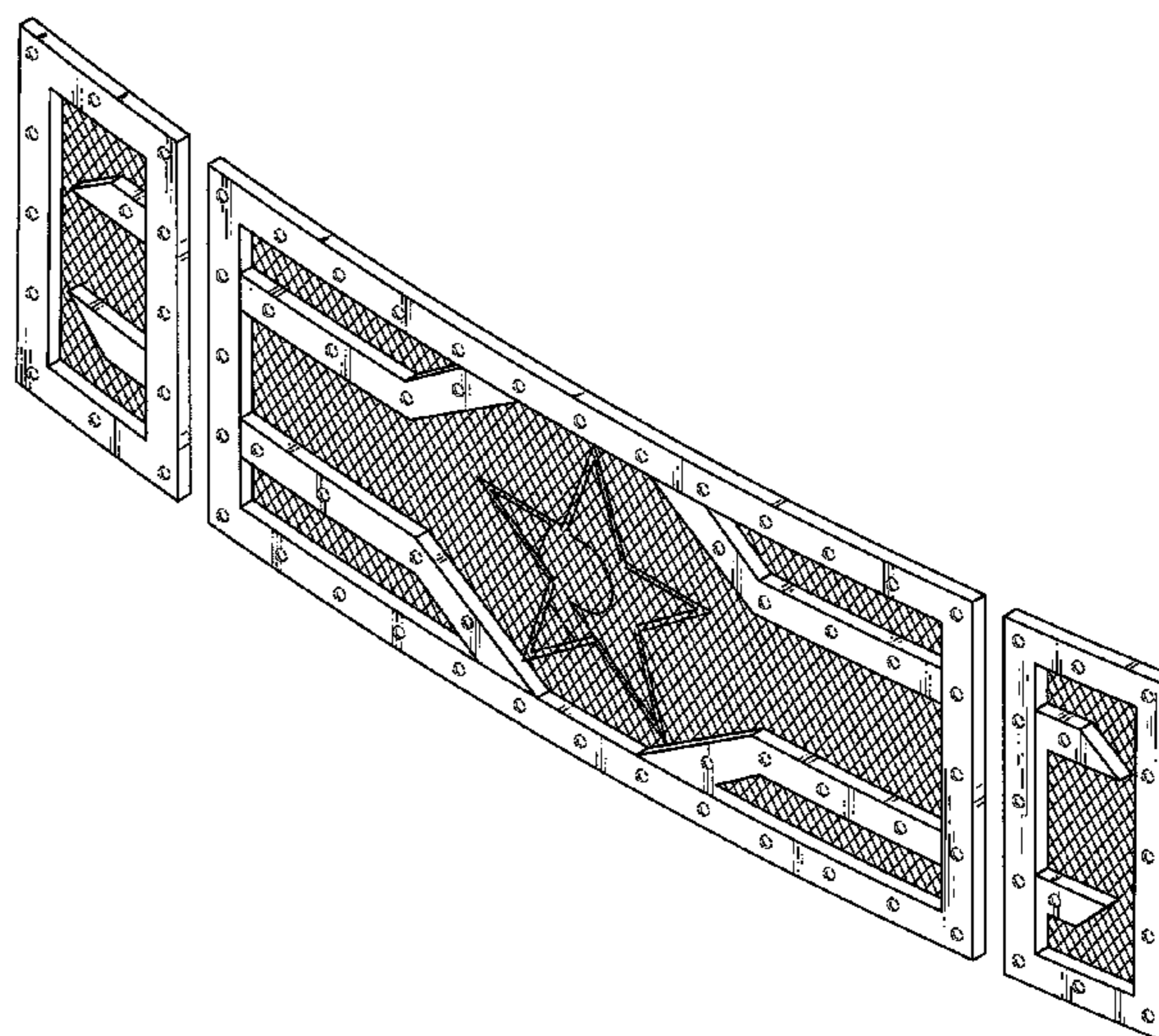
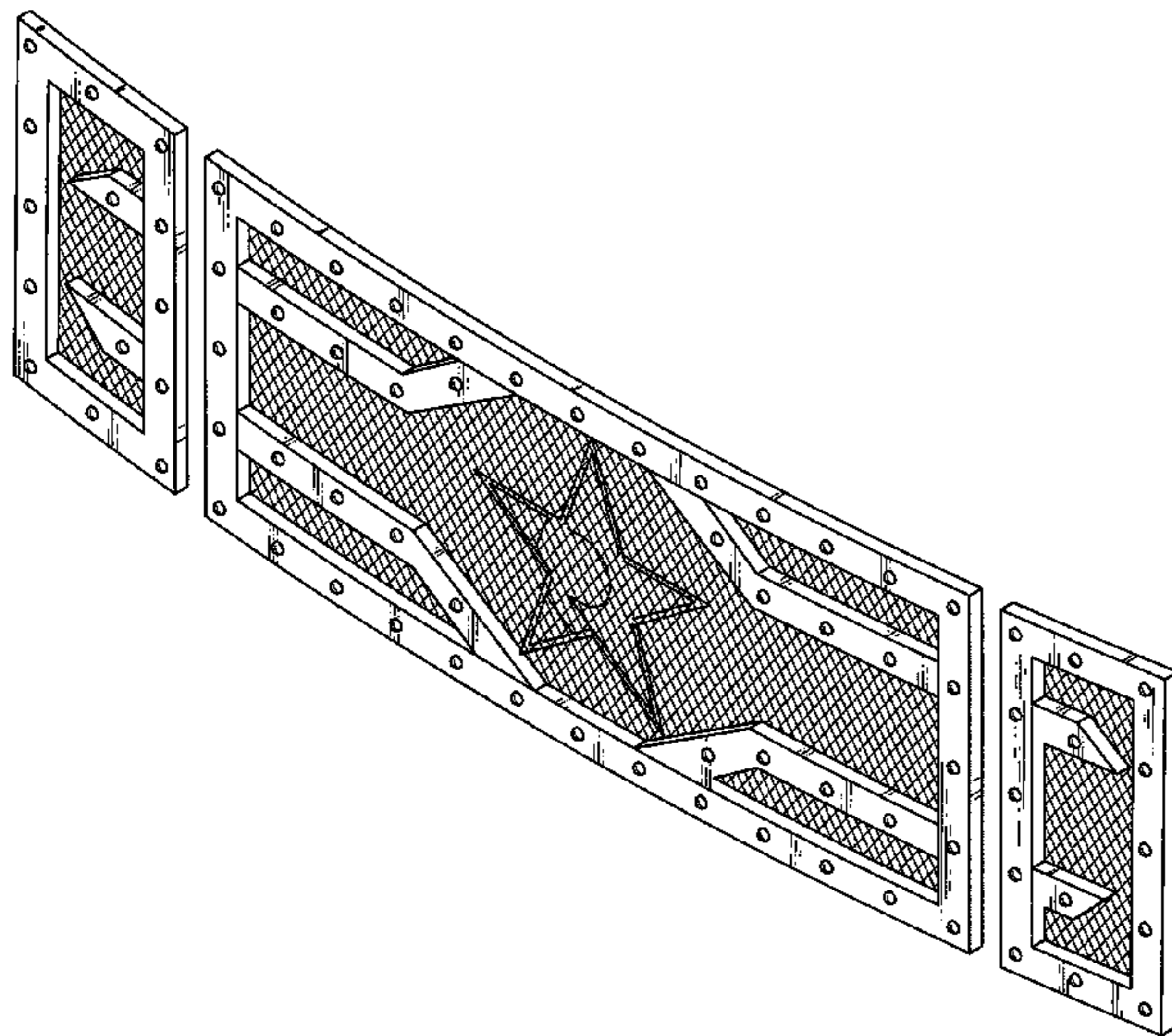

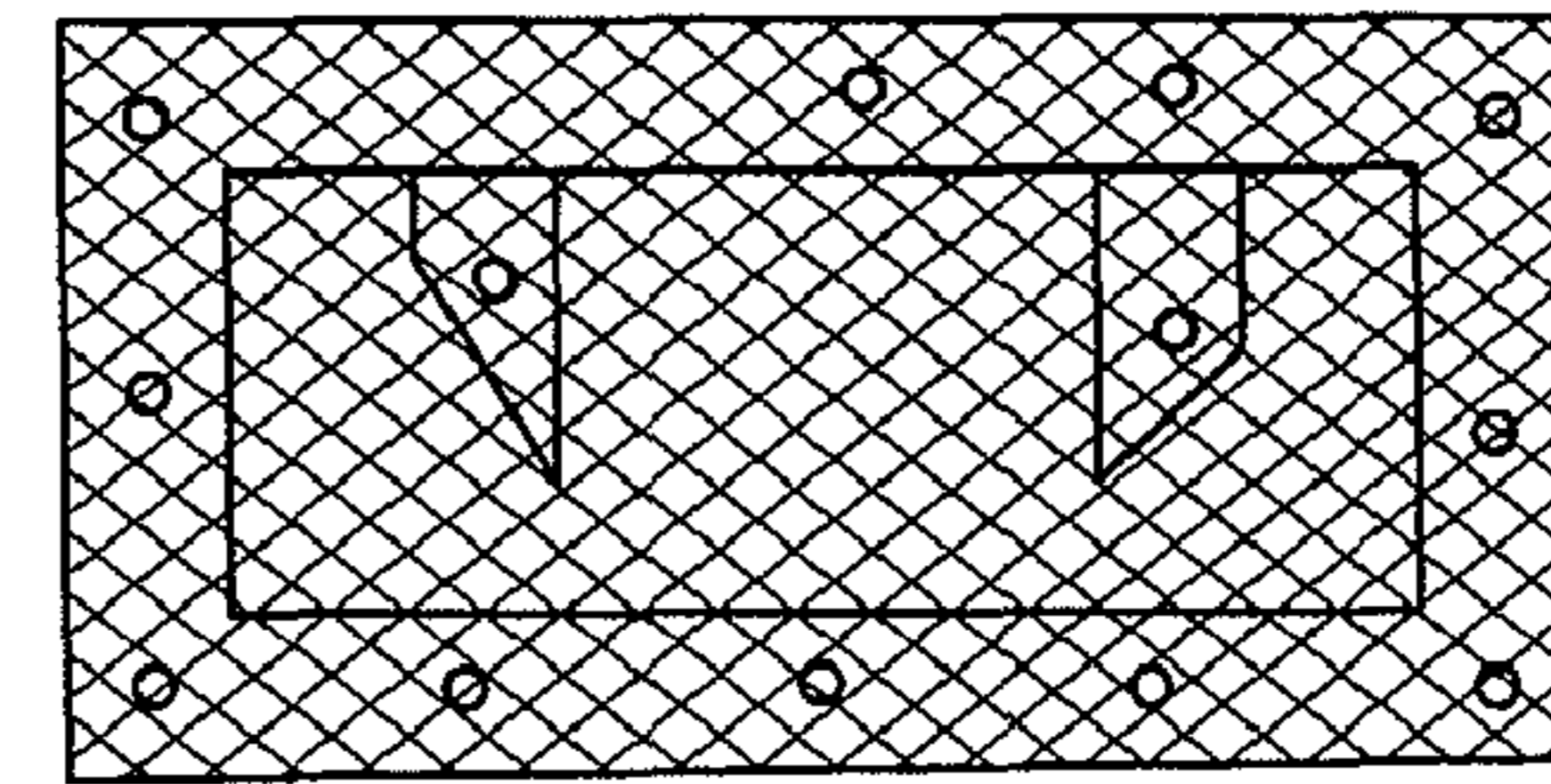
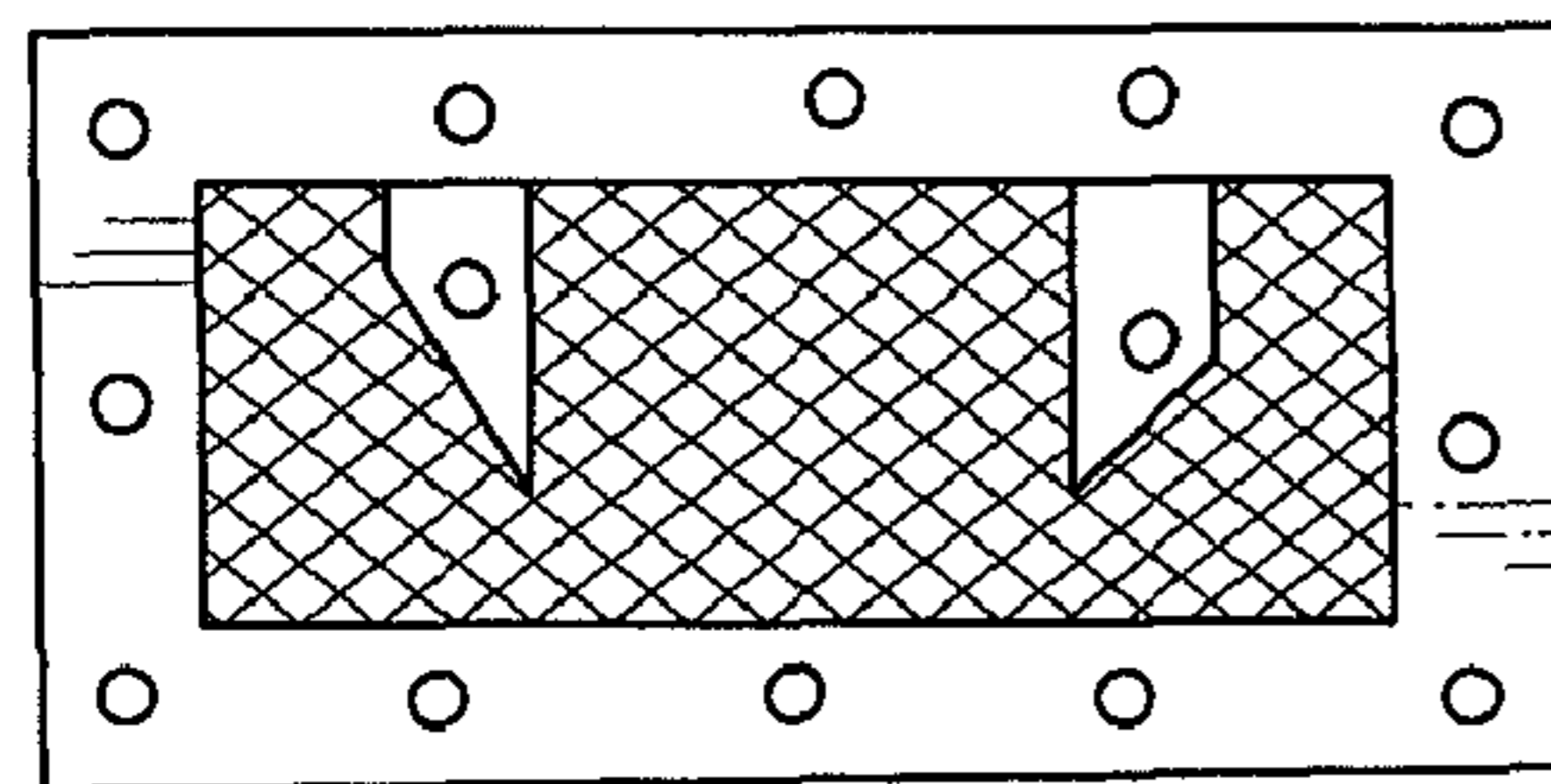
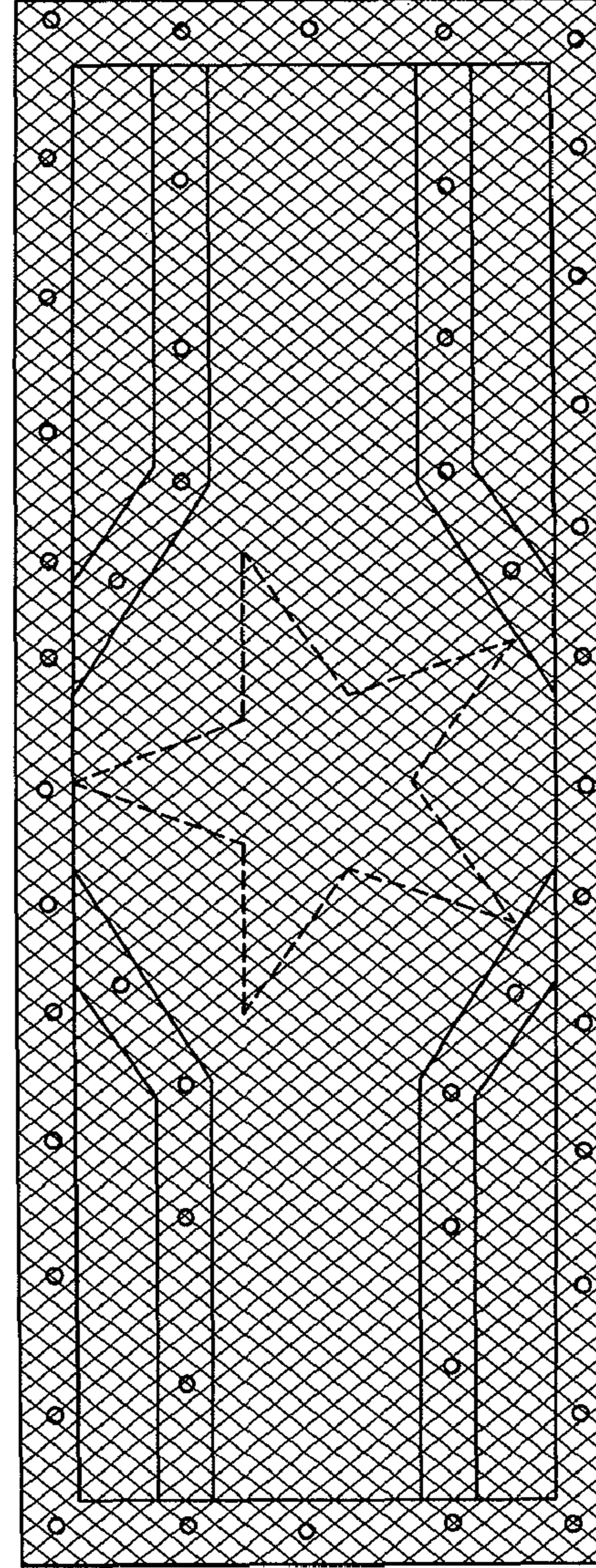
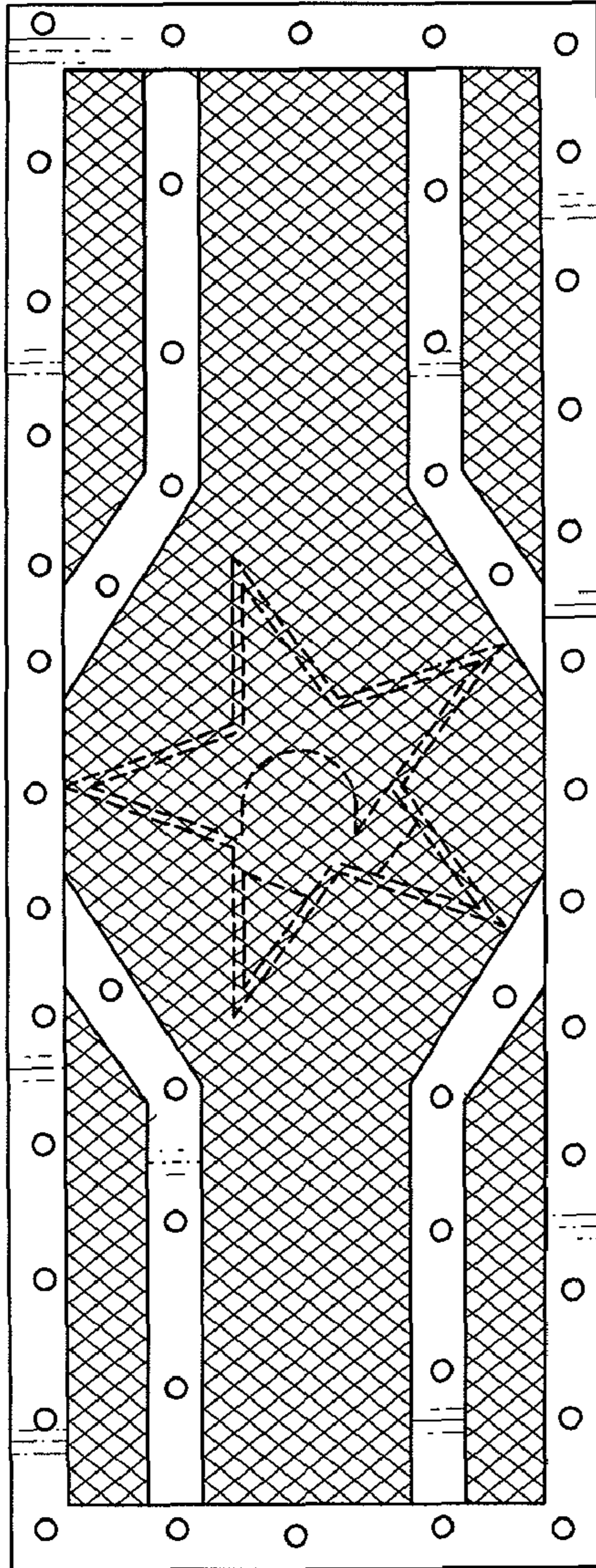
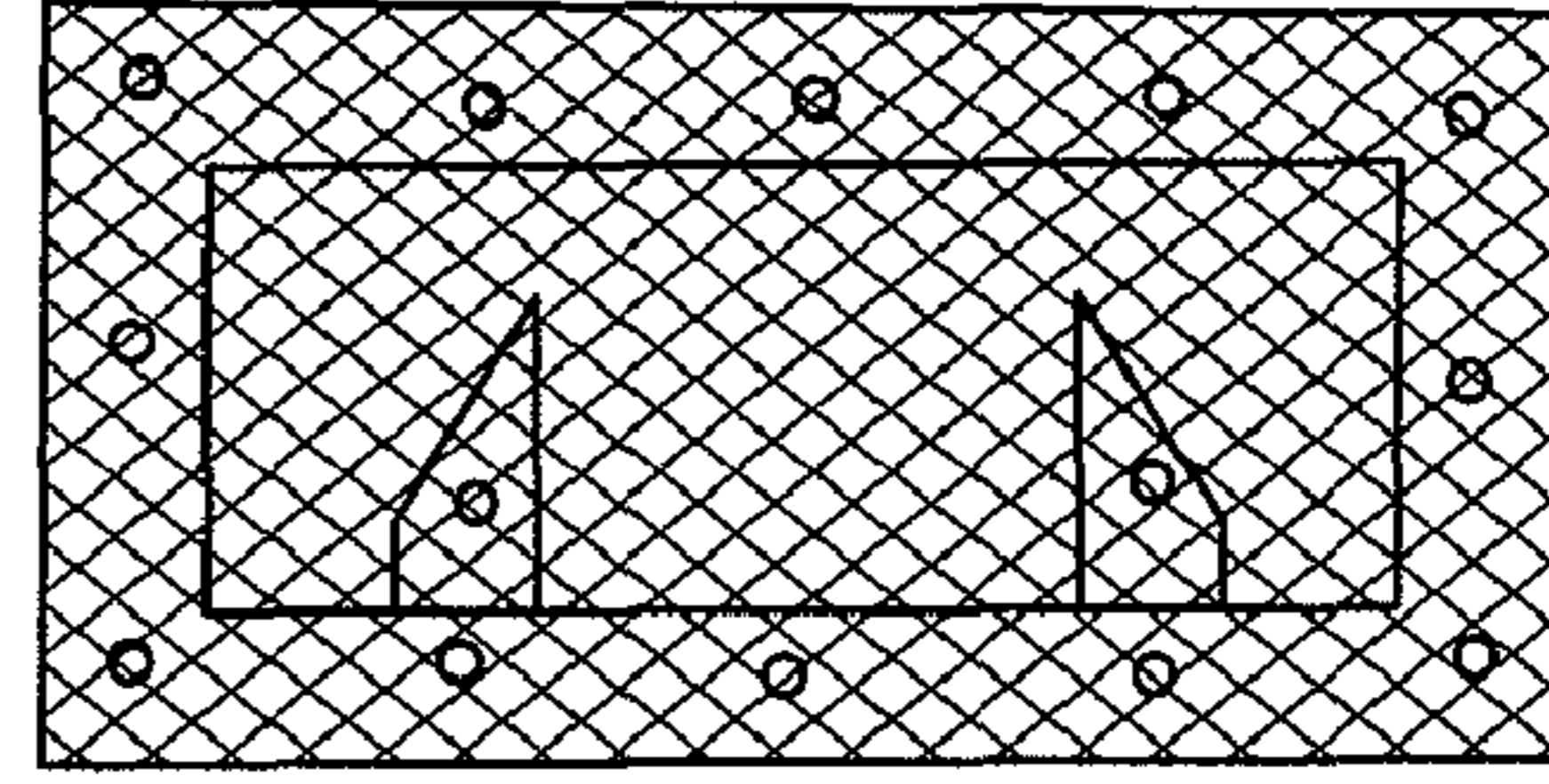
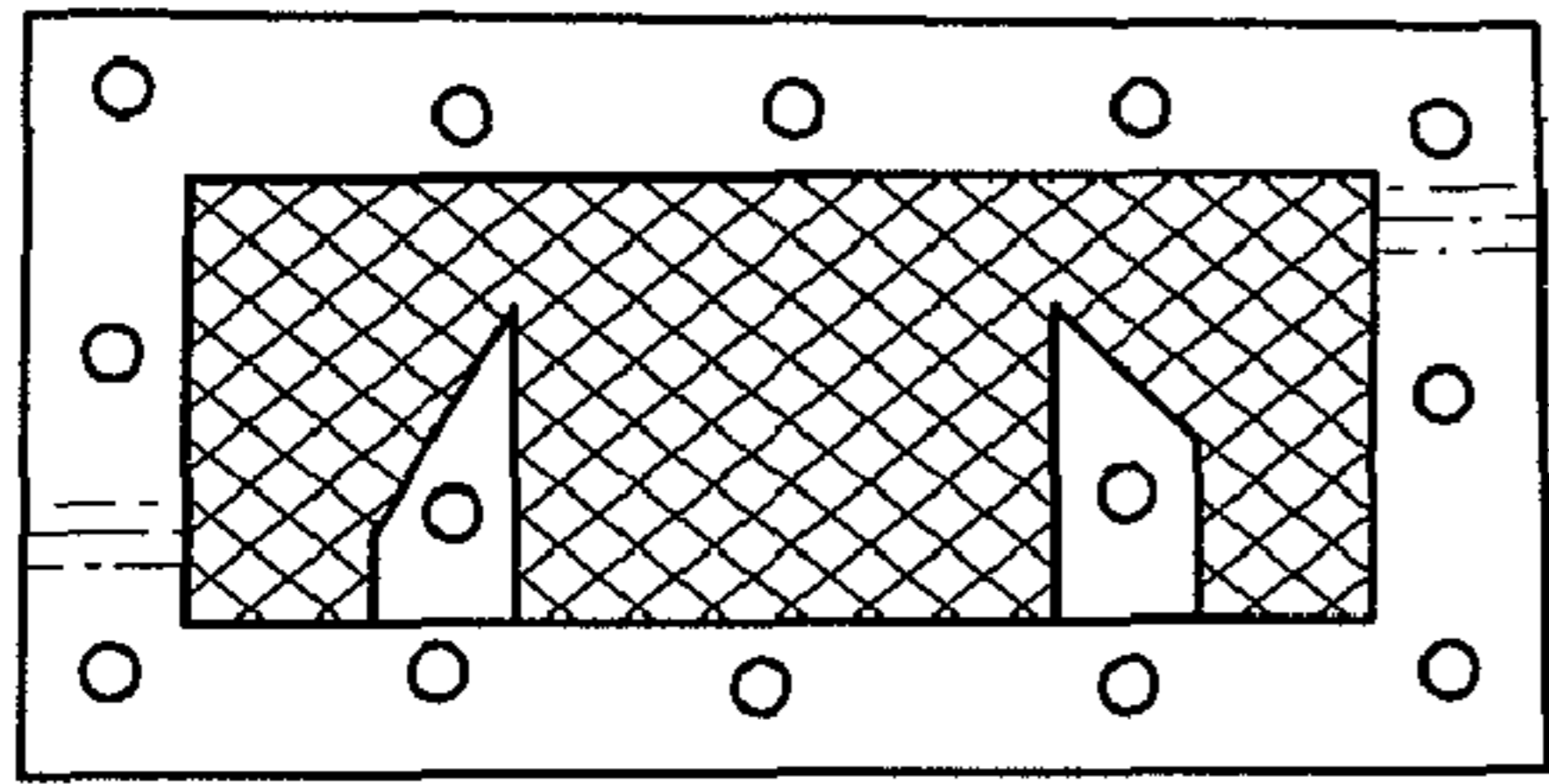

FIG. 1

FIG. 2



FIG. 3

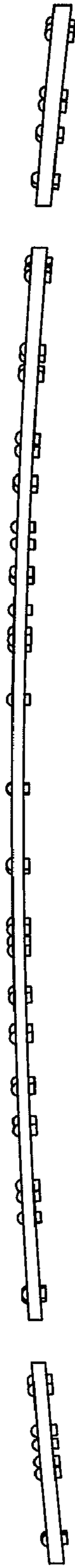

FIG. 4

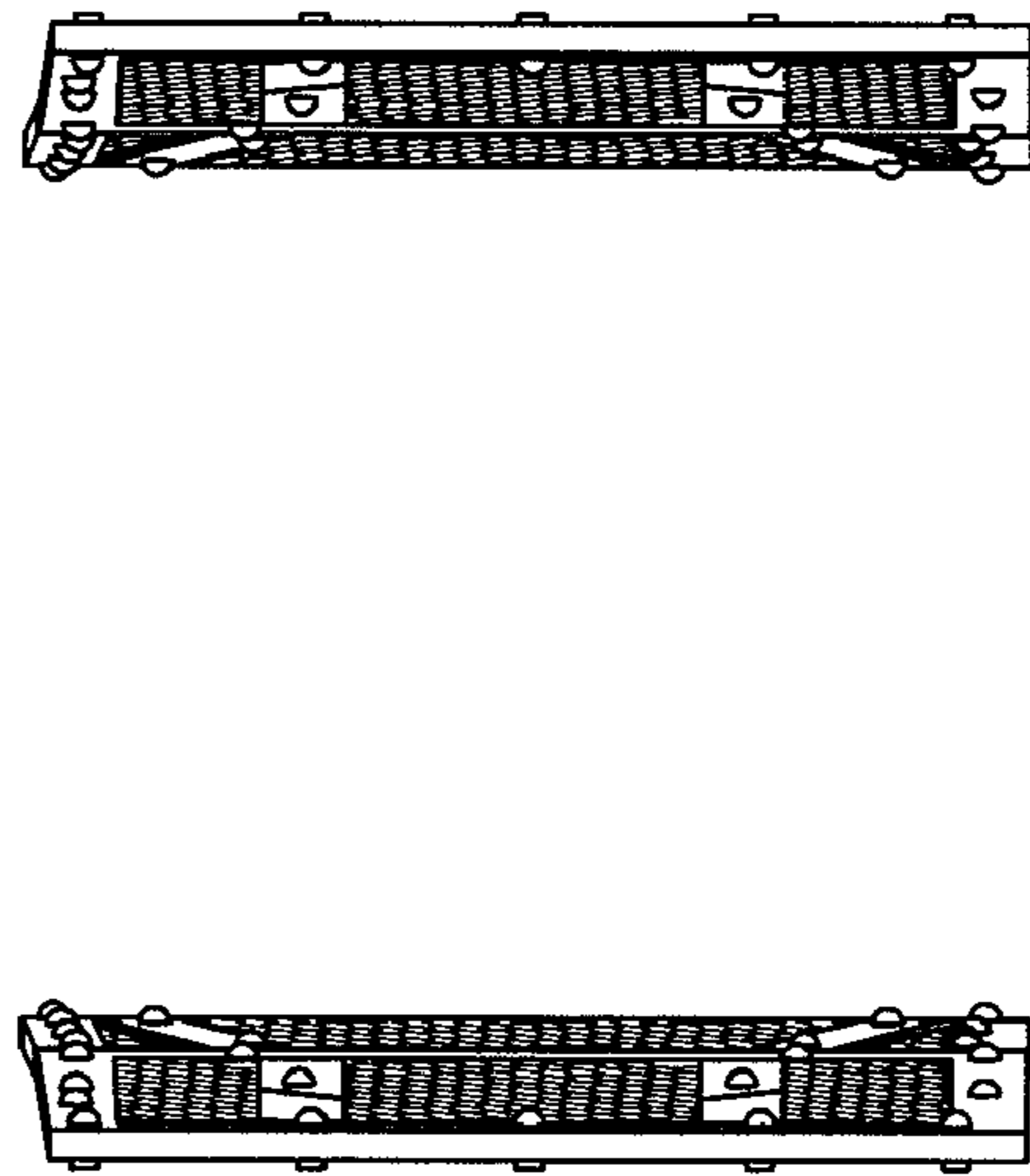

FIG. 5

FIG. 6

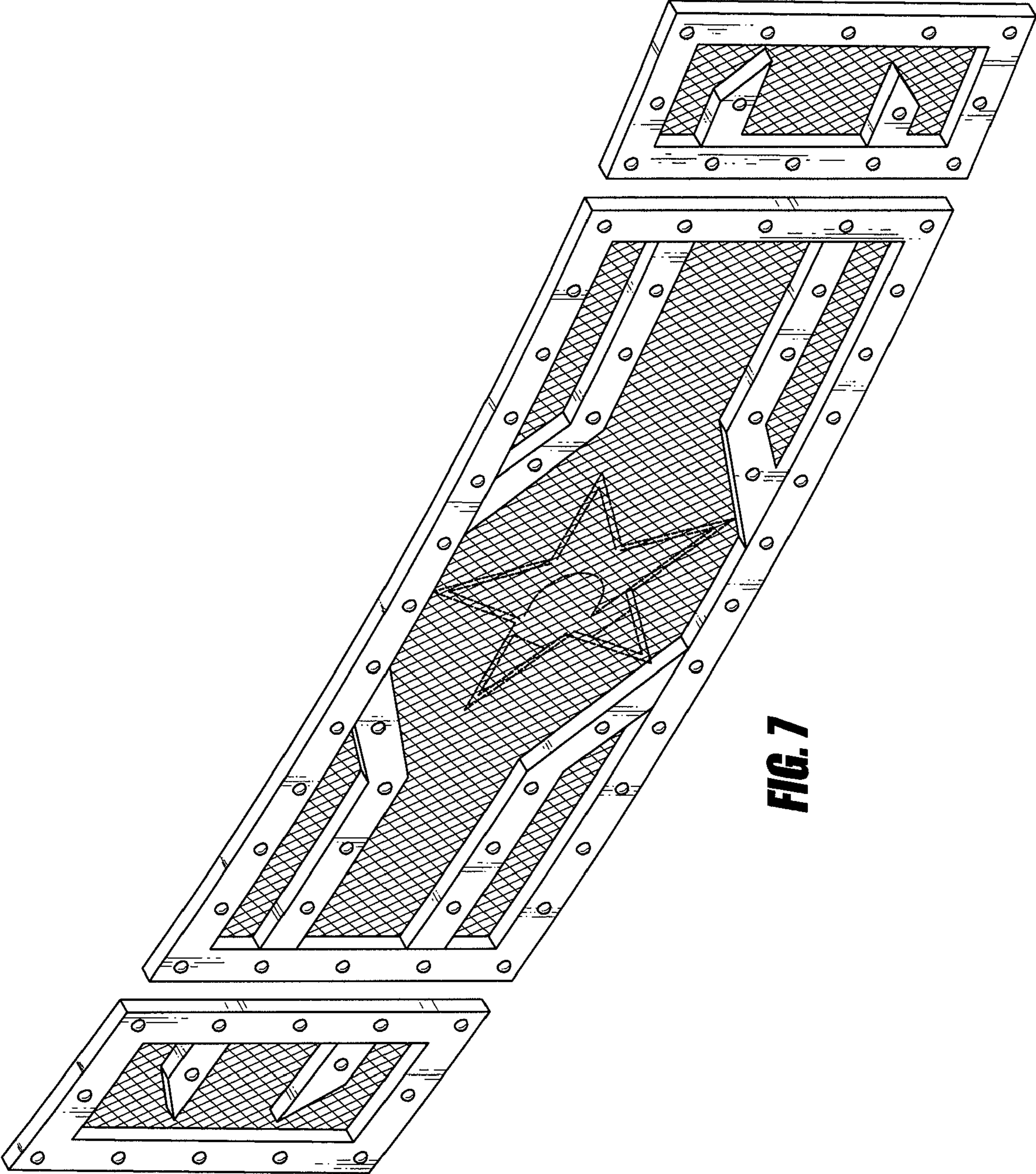

FIG. 7

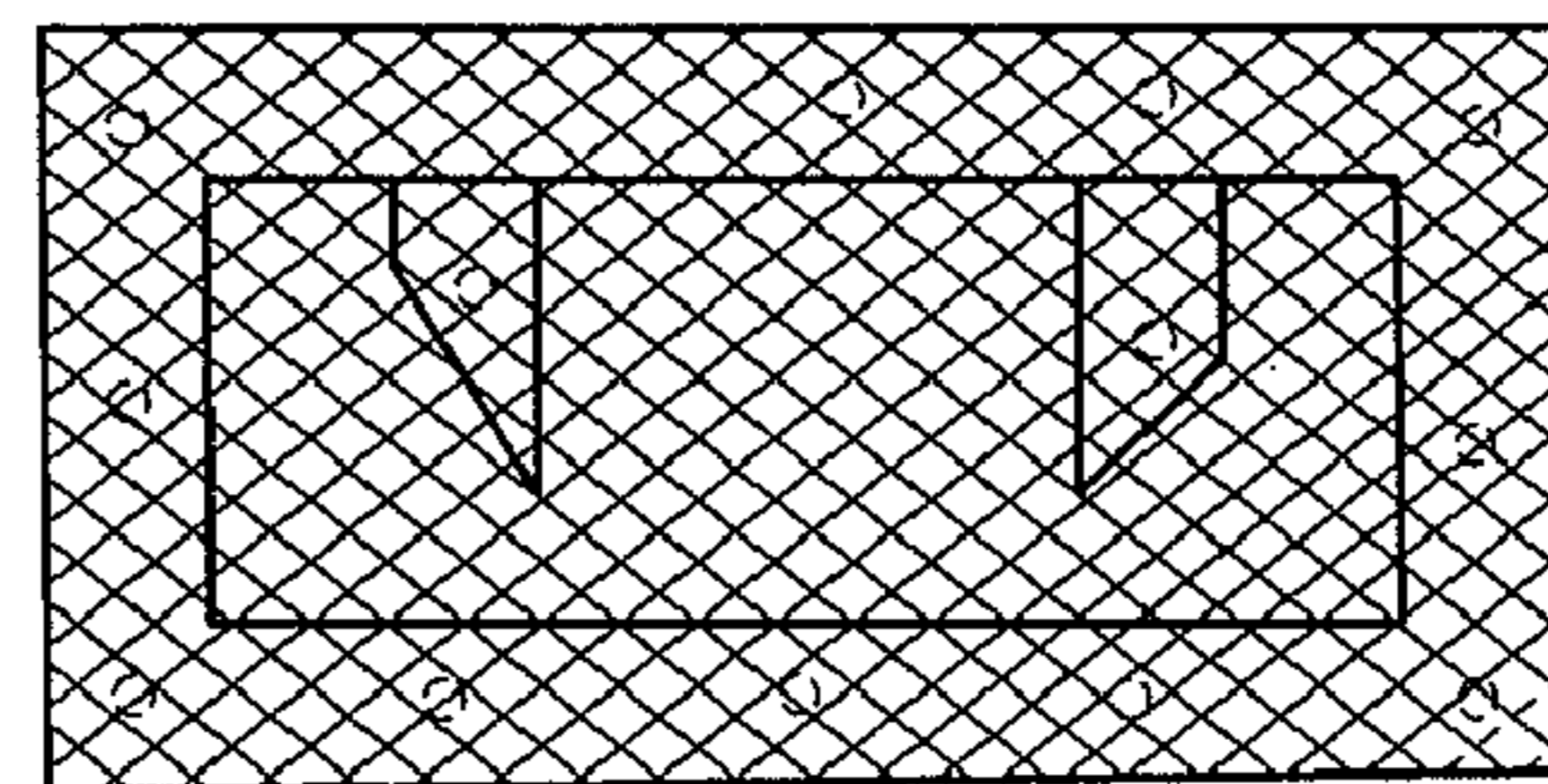
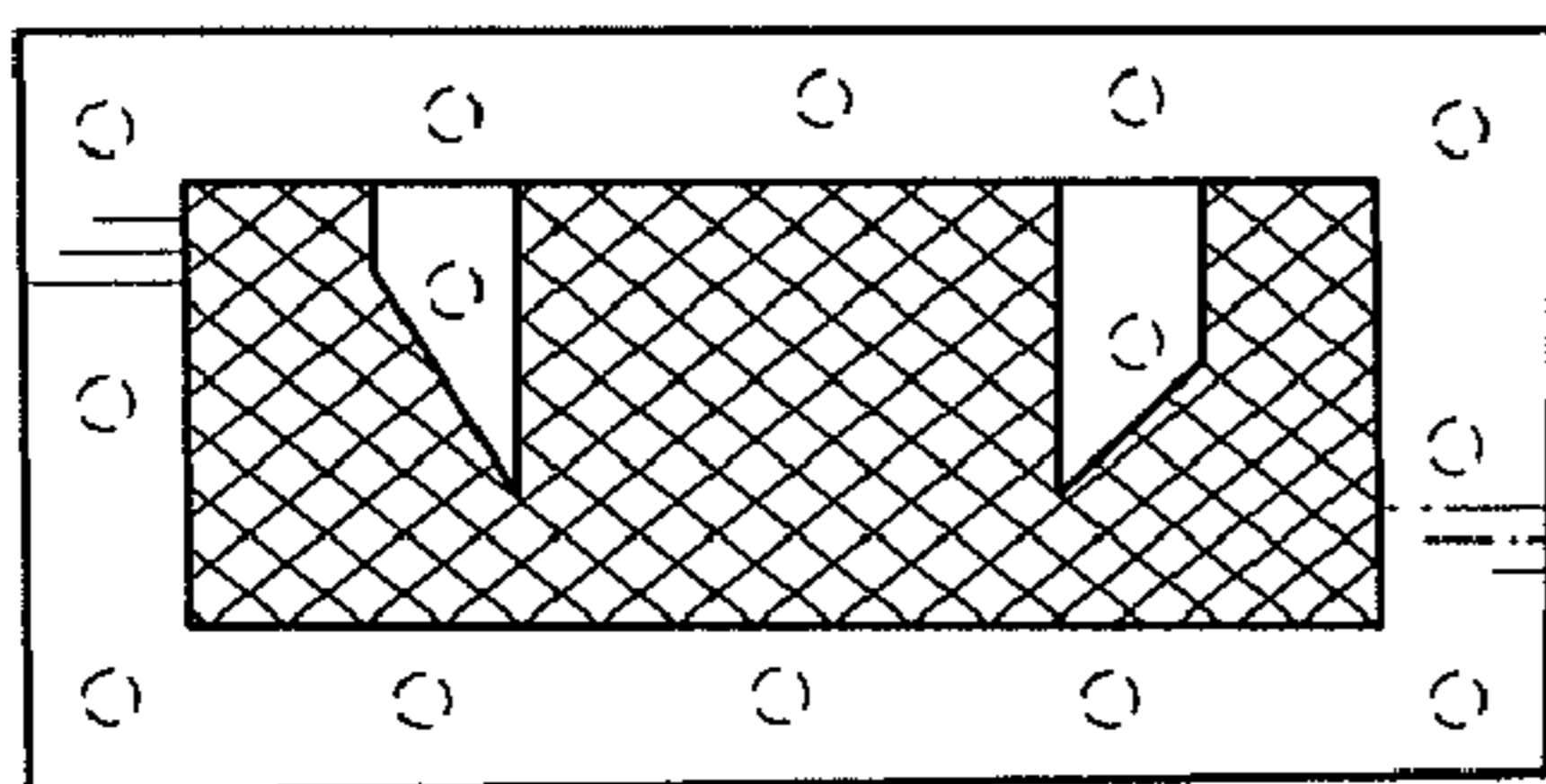
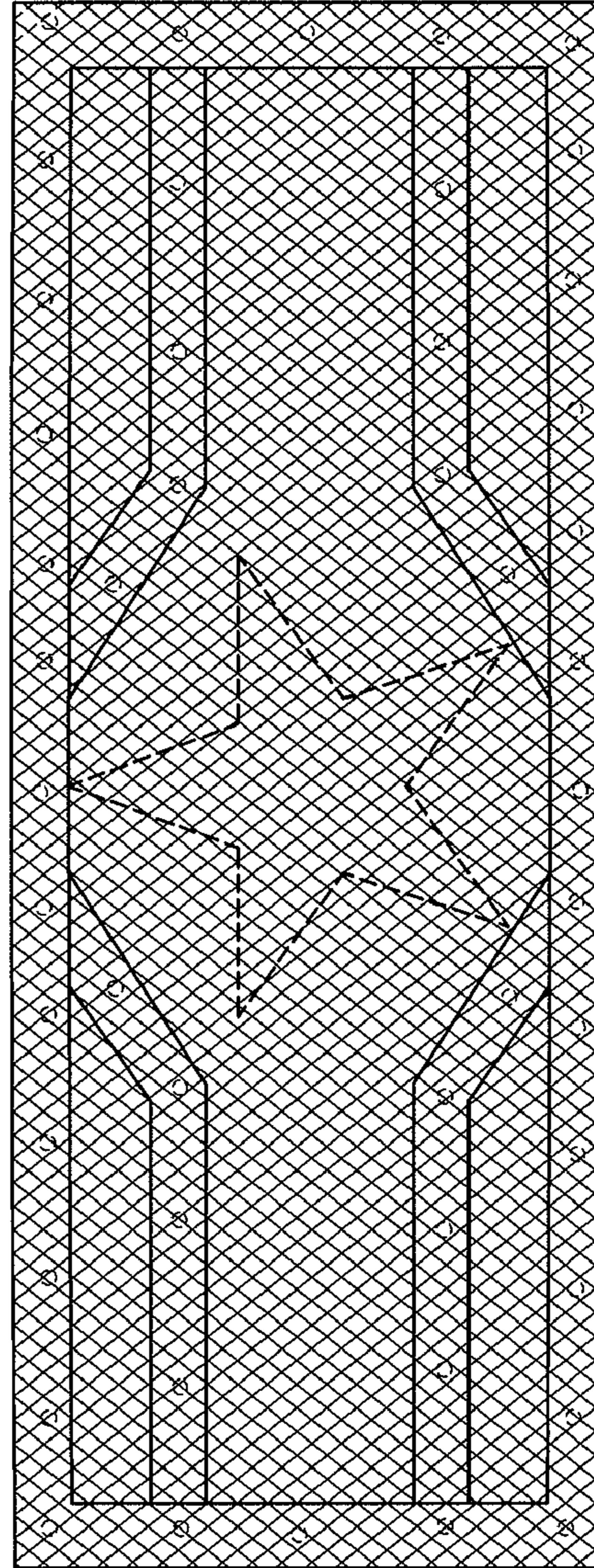
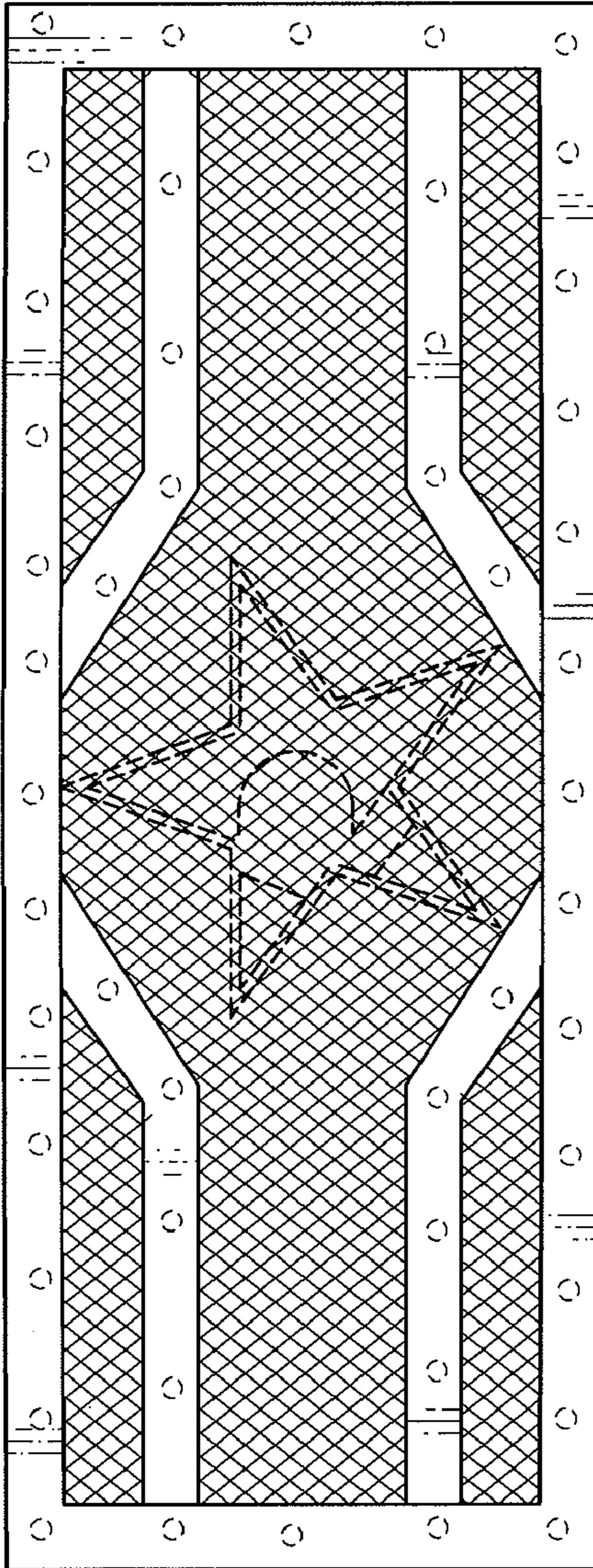
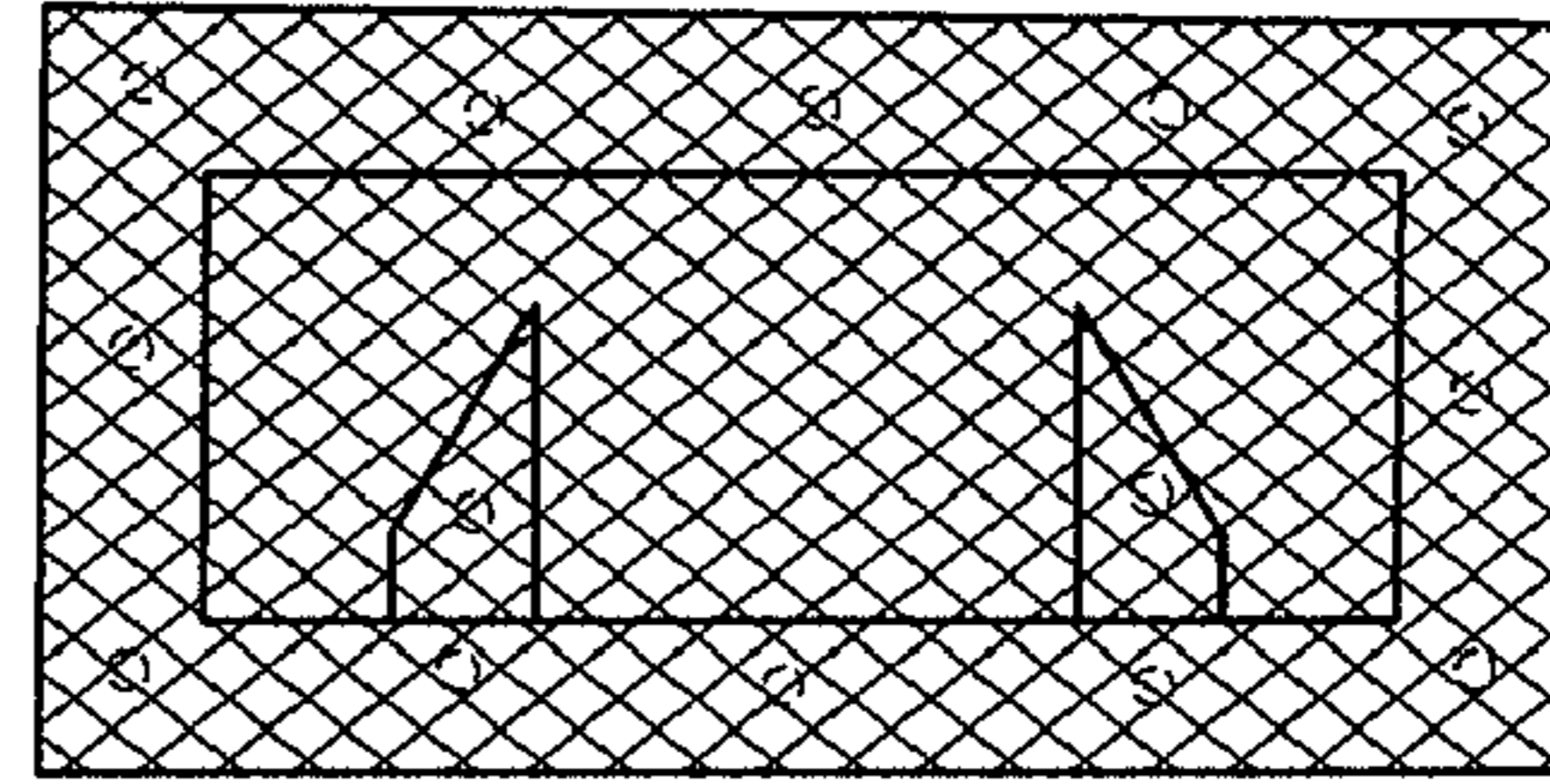
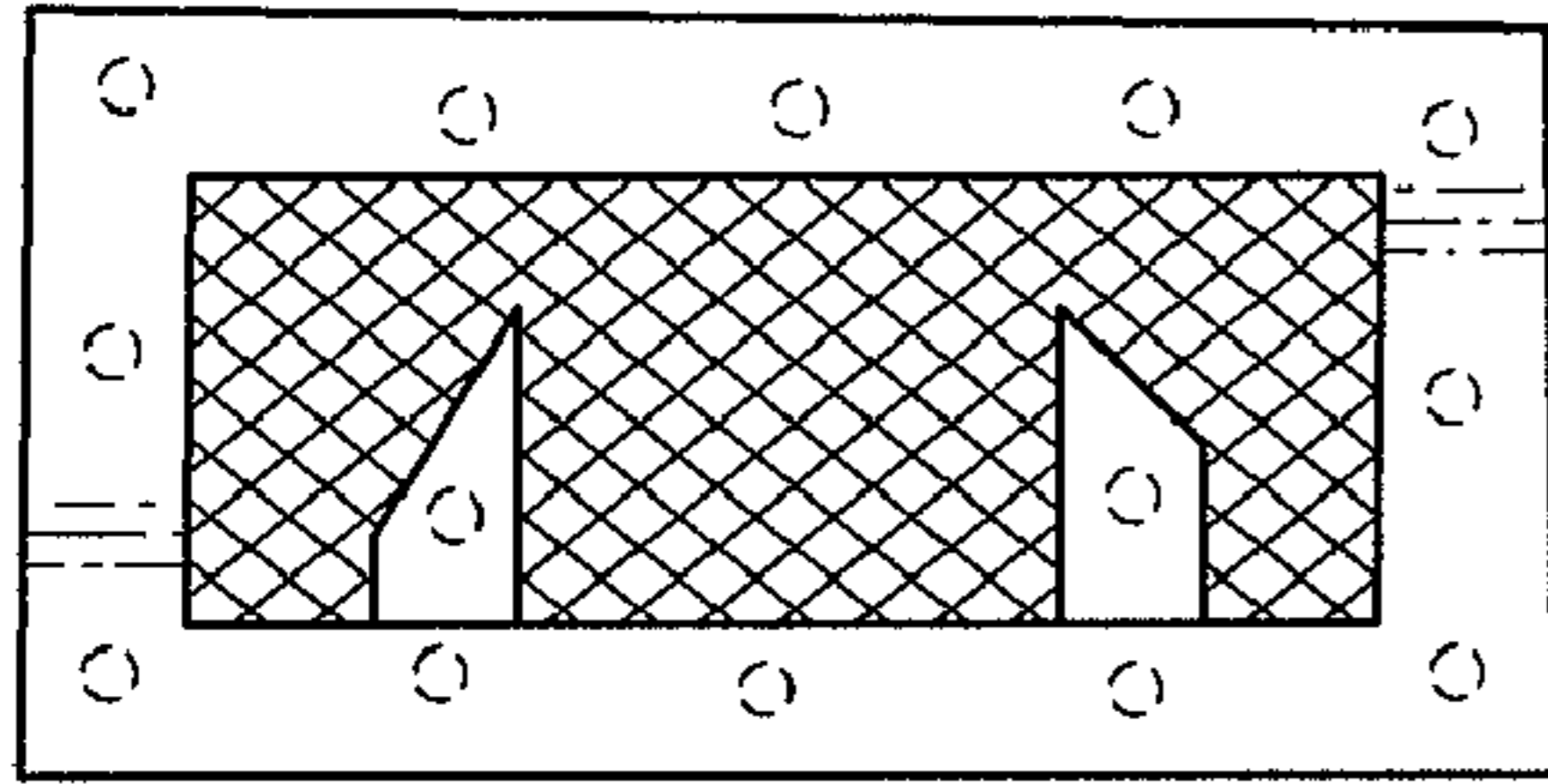

FIG. 8

FIG. 9

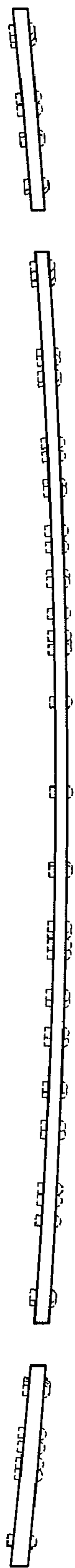

FIG. 10

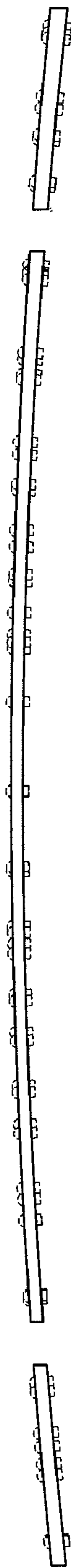

FIG. 11

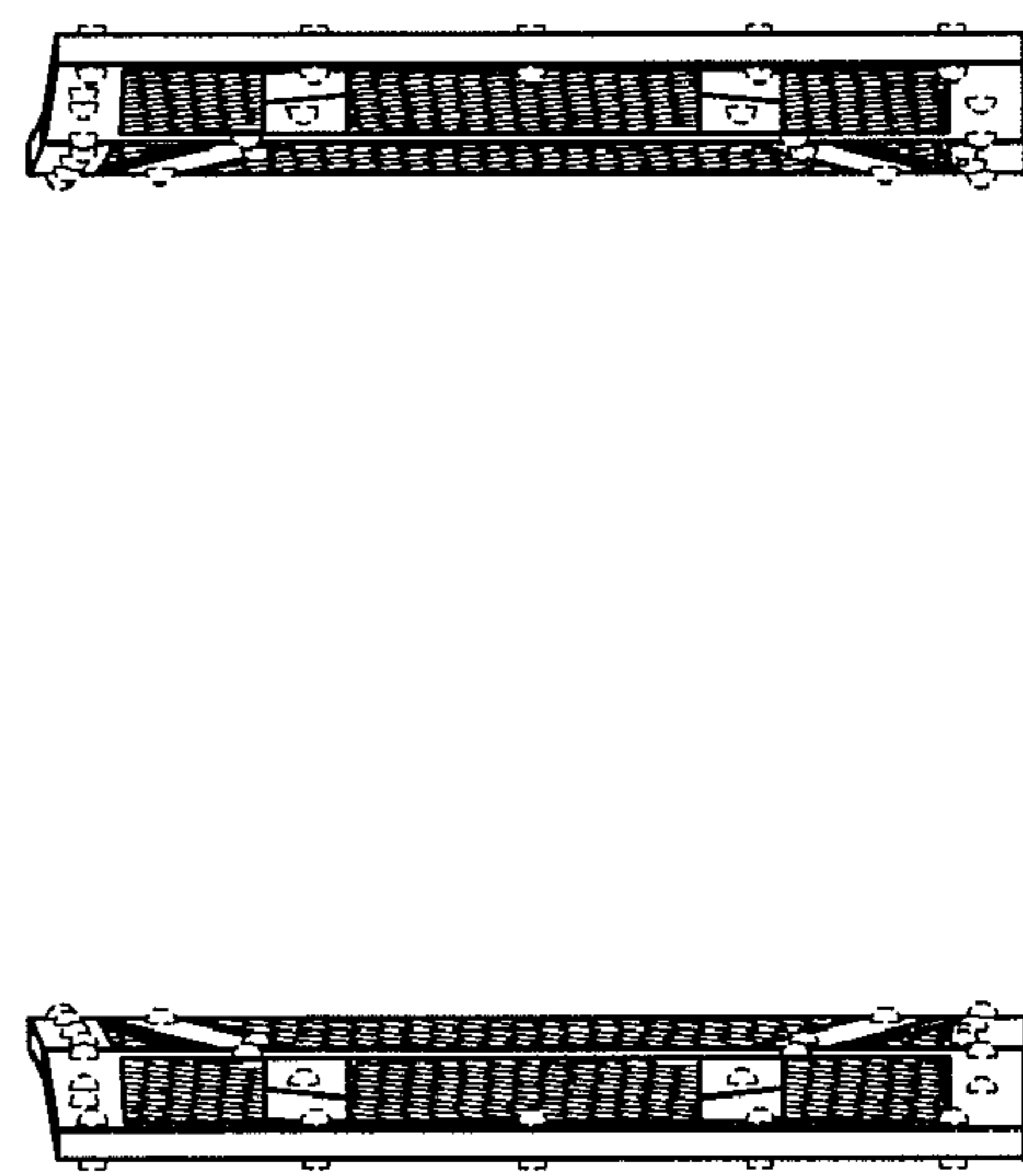

FIG. 12

FIG. 13

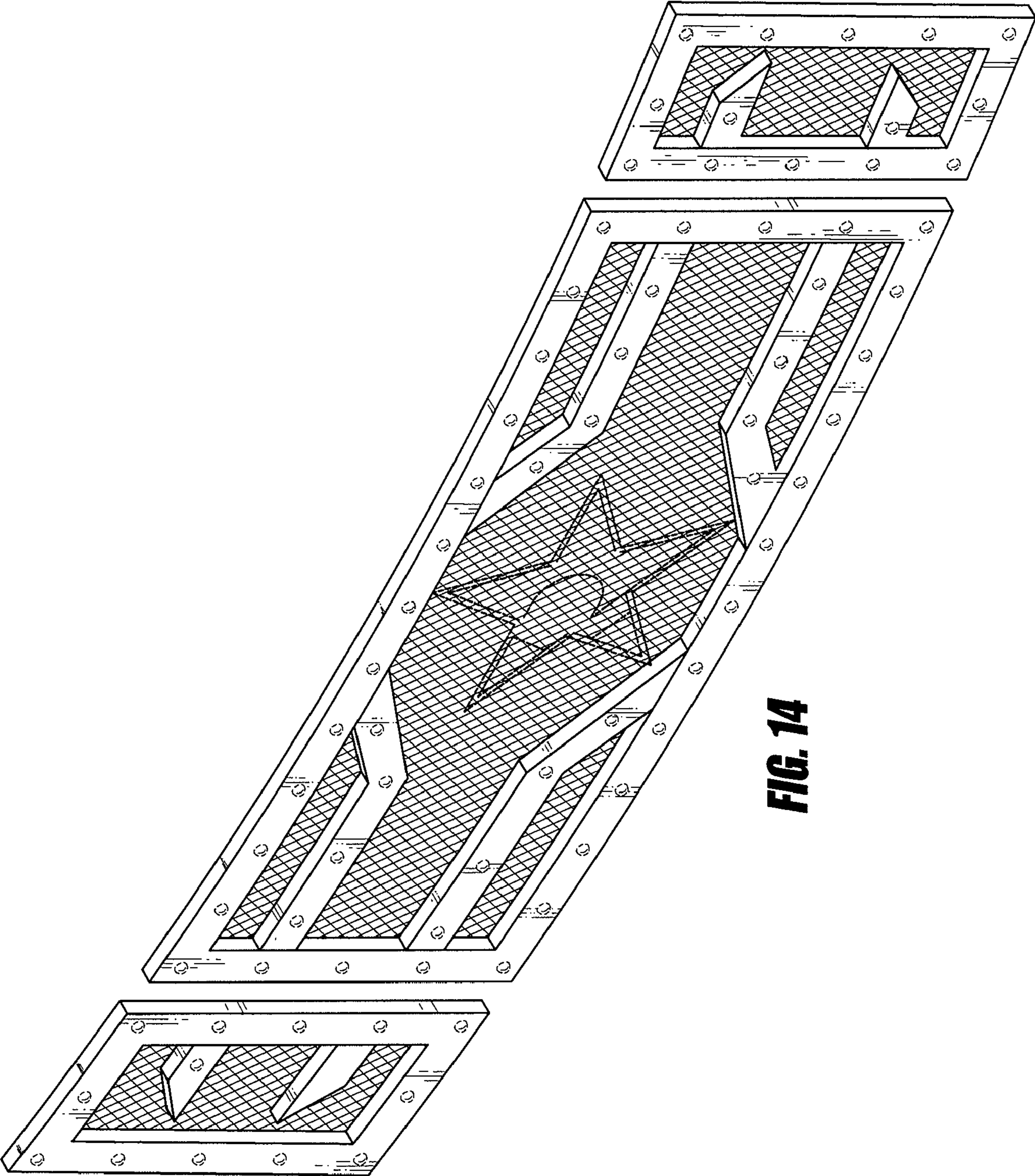

FIG. 14