



US00D631393S

(12) **United States Design Patent**
Shani et al.

(10) **Patent No.:** **US D631,393 S**
(45) **Date of Patent:** **** Jan. 25, 2011**

(54) **BELT BUCKLE**

(57) **CLAIM**

(76) Inventors: **Tal Shani**, 13 Kaplain Street, Petach Tikva 49451 (IL); **Micky Weinstein**, 43/6 Hafetz Haim Street, Petach Tikva 49350 (IL)

We claim the ornamental design for a belt buckle, as shown and described herein.

(**) Term: **14 Years**

DESCRIPTION

(21) Appl. No.: **29/345,963**

FIG. 1 is a top view of a belt buckle according to a first embodiment of our new design.

(22) Filed: **Oct. 23, 2009**

FIG. 2 is a bottom view thereof.

(30) **Foreign Application Priority Data**

Apr. 23, 2009	(IL)	47602
Apr. 23, 2009	(IL)	47603
Apr. 23, 2009	(IL)	47604
Apr. 23, 2009	(IL)	47605
Apr. 23, 2009	(IL)	47606

FIG. 3 is a left side view thereof.

FIG. 4 is a right side view thereof.

FIG. 5 is an elevated perspective view of the top thereof.

FIG. 6 is an elevated perspective view of the top thereof.

FIG. 7 is an elevated perspective view of the top thereof.

FIG. 8 is an elevated perspective view of the top thereof.

FIG. 9 is an elevated perspective view of the bottom thereof.

(51) **LOC (9) Cl.** **02-07**

FIG. 10 is a front view thereof.

(52) **U.S. Cl.** **D11/216**

FIG. 11 is a back view thereof.

(58) **Field of Classification Search** D11/1-2, D11/200-201, 203-206, 210, 212, 214-219, D11/222, 224, 226; 24/163 R, 169-171, 24/173, 177-179, 191, 194-195, 197, 200
See application file for complete search history.

FIG. 12 is a side view thereof.

FIG. 13 is a bottom view thereof.

FIG. 14 is a rear view thereof.

FIG. 15 is a top view thereof.

(56) **References Cited**

U.S. PATENT DOCUMENTS

2,110,684	A *	3/1938	Schuhmann	24/313
D117,747	S *	11/1939	Freysinger	D11/215
2,531,244	A *	11/1950	Andrus	24/504
D177,056	S *	3/1956	Lowrie	D11/1
D332,585	S *	1/1993	Olson	D11/201
D414,401	S *	9/1999	Aganian	D8/383
D596,986	S *	7/2009	Gastaldi	D11/216
7,657,978	B2 *	2/2010	Lin	24/614

FIG. 16 is an elevated perspective view of the top, rear view thereof.

FIG. 17 is an elevated perspective view of the top, front view thereof.

FIG. 18 is an elevated perspective view of the bottom, front view thereof.

FIG. 19 is a side view thereof.

FIG. 20 is a bottom view thereof.

FIG. 21 is a rear view thereof.

FIG. 22 is a top view thereof.

FIG. 23 is an elevated perspective view of the top, rear view thereof.

FIG. 24 is an elevated perspective view of the bottom, rear view thereof.

* cited by examiner

Primary Examiner—Ralf Seifert

(74) *Attorney, Agent, or Firm*—Ostrolenk Faber LLP

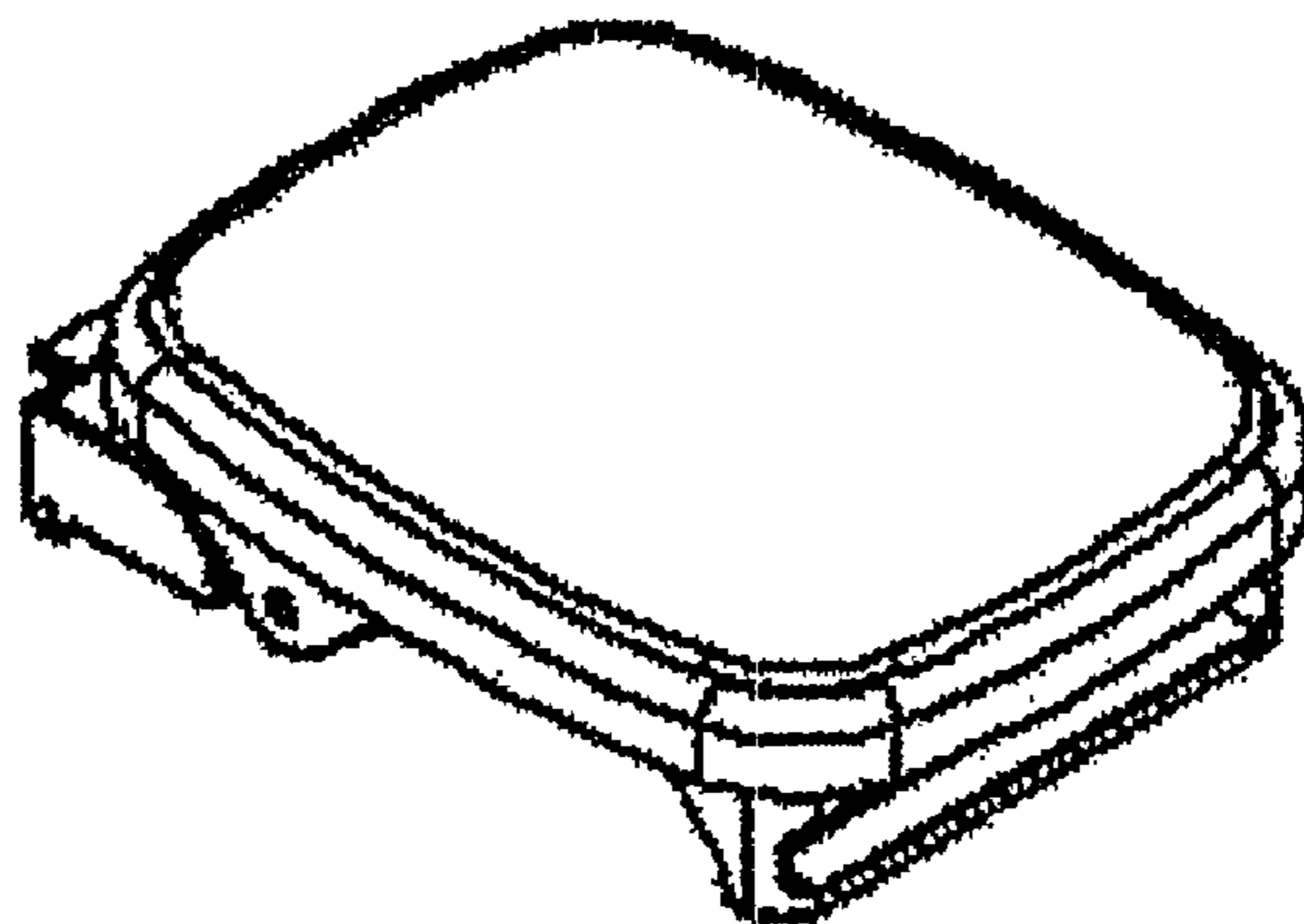

FIG. **25** is an elevated perspective view of the bottom, front view thereof.

FIG. **26** is a side view thereof.

FIG. **27** is a bottom view thereof.

FIG. **28** is a rear view thereof.

FIG. **29** is a top view thereof.

FIG. **30** is an elevated perspective view of the top, rear view thereof.

FIG. **31** is an elevated perspective side view thereof; and,

FIG. **32** is an elevated perspective view of the bottom, top view thereof.

The portions of the drawings appearing in broken lines are for illustrative purposes only and form no part of the claimed design.

1 Claim, 4 Drawing Sheets

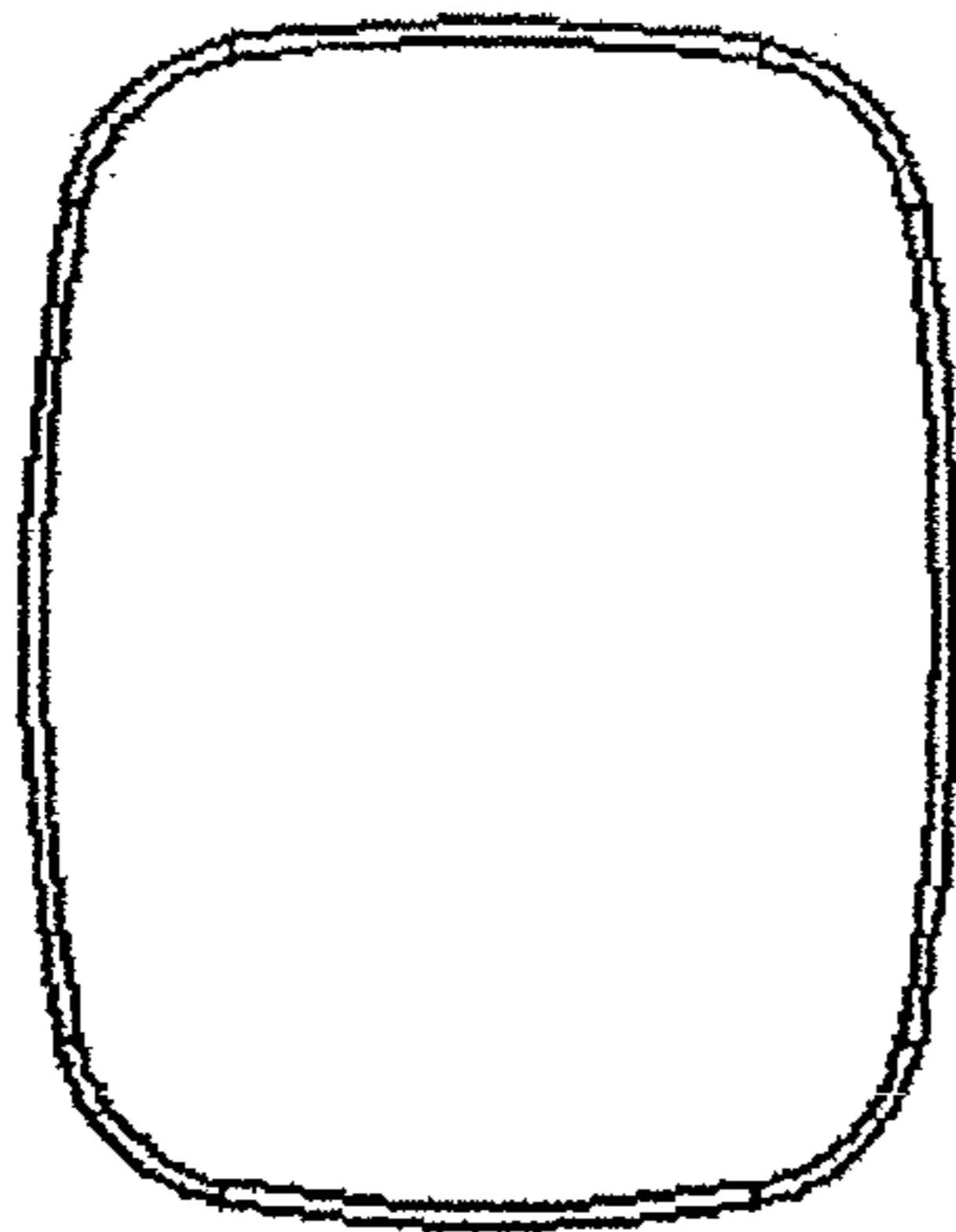

Fig. 1

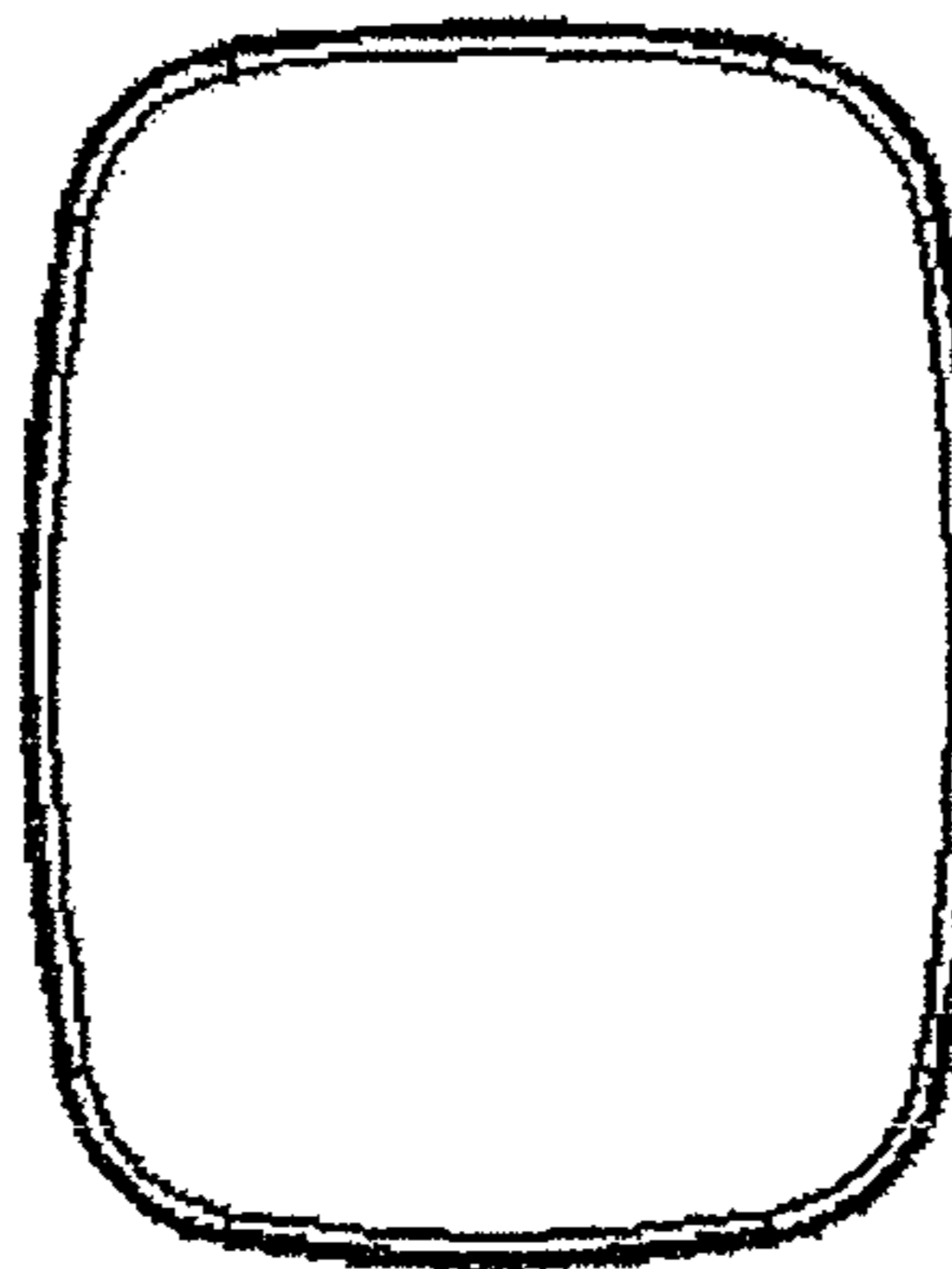

Fig. 2



Fig. 3

Fig. 4

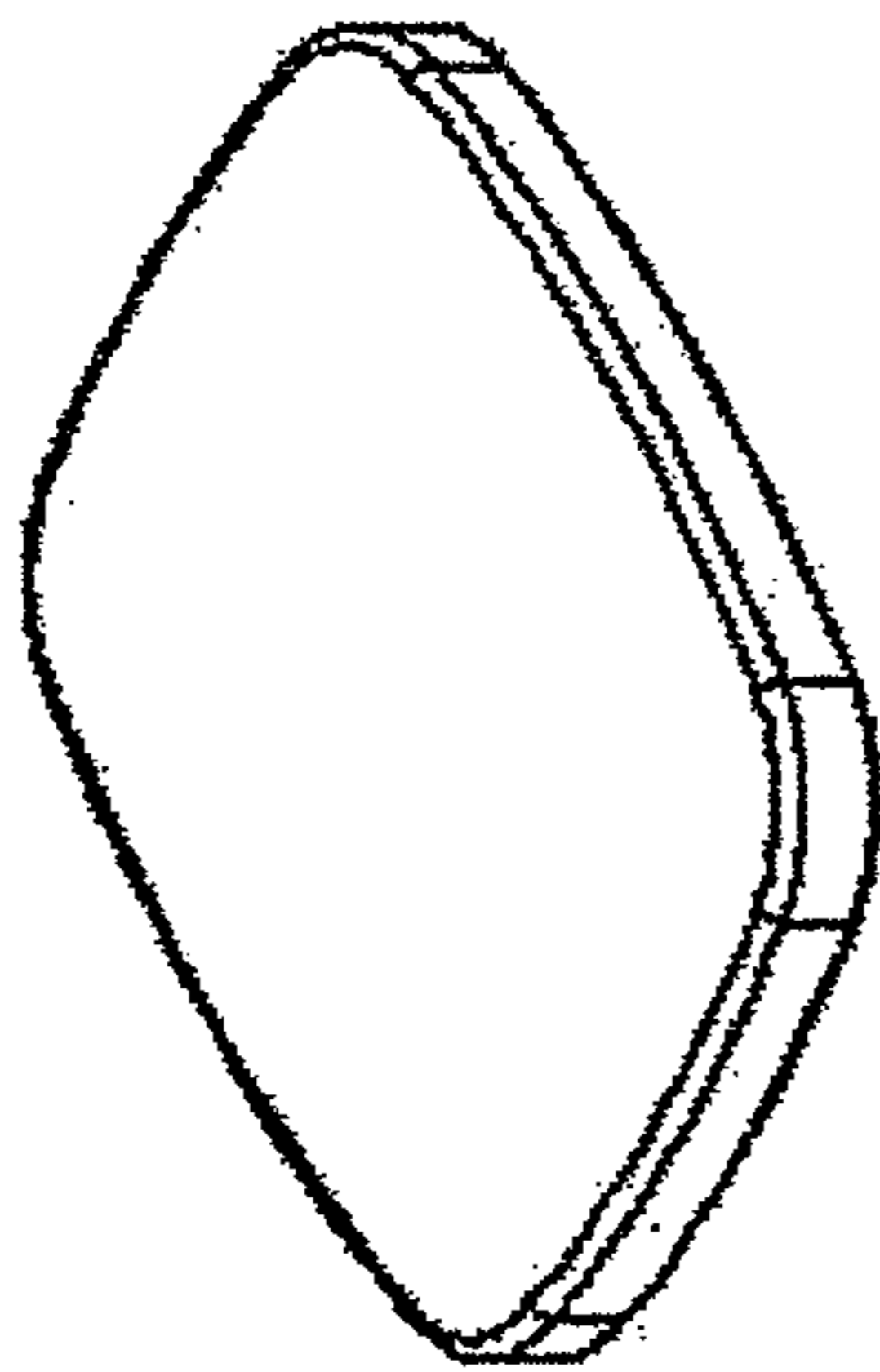

Fig. 5

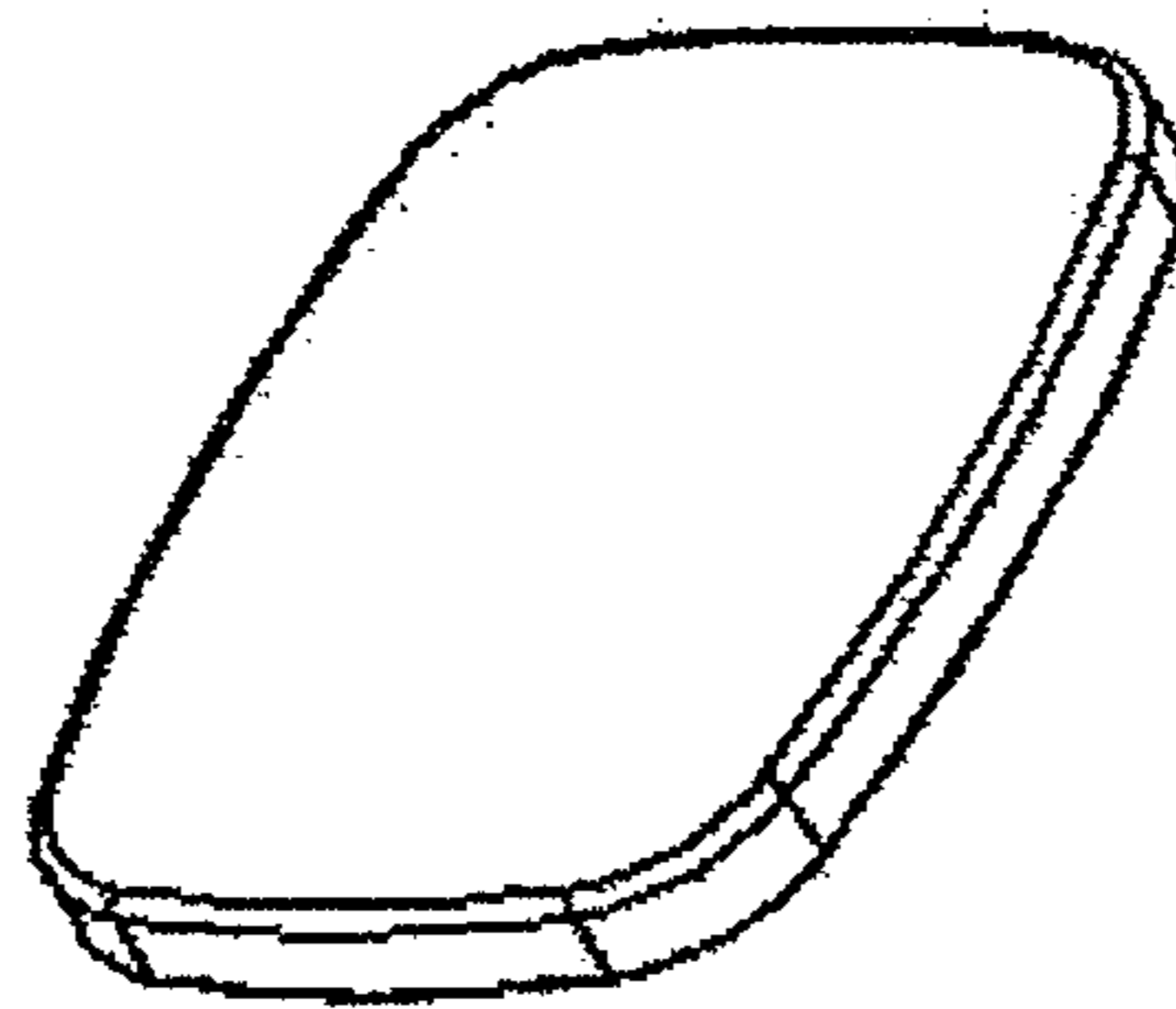

Fig. 6

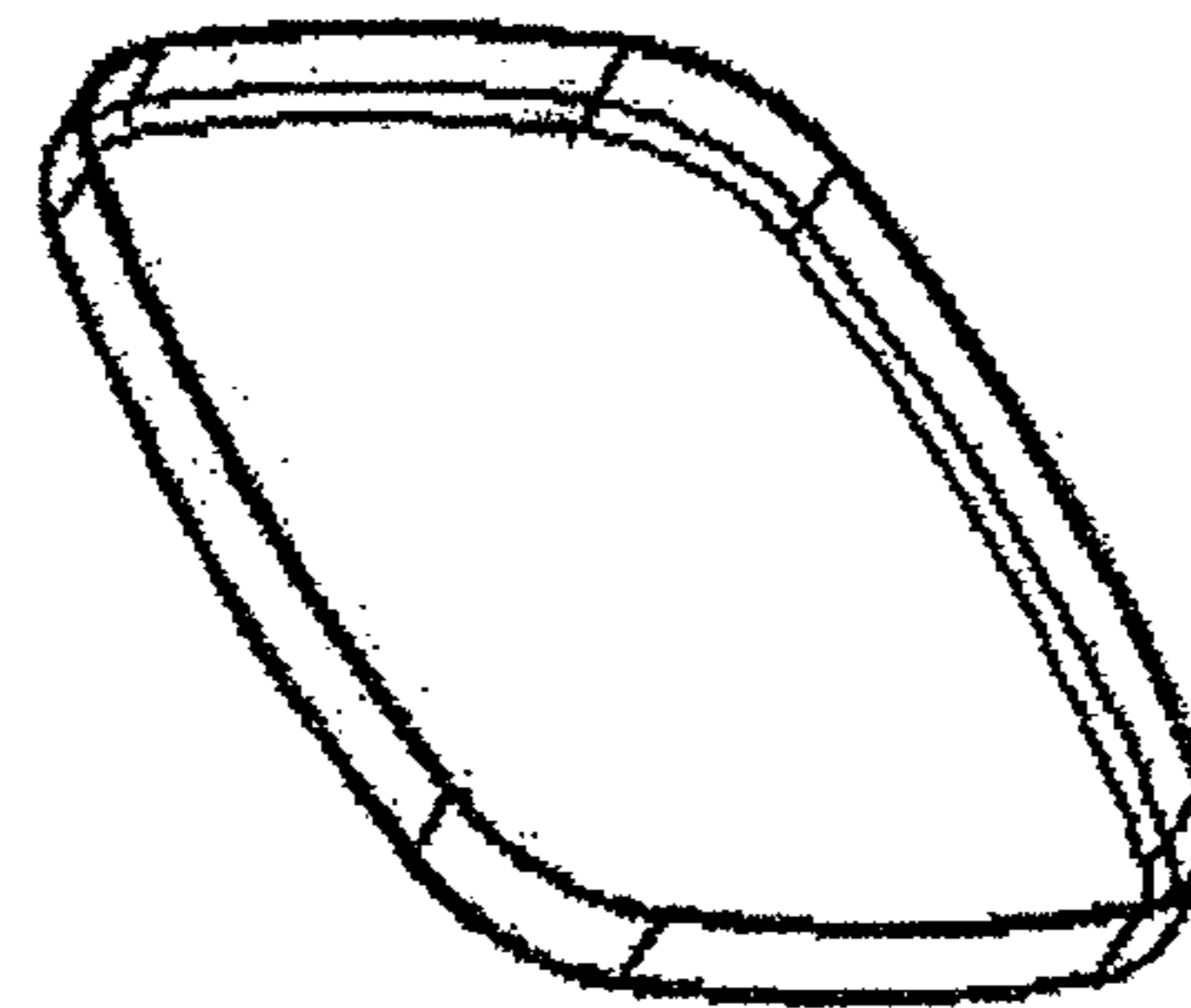

Fig. 9

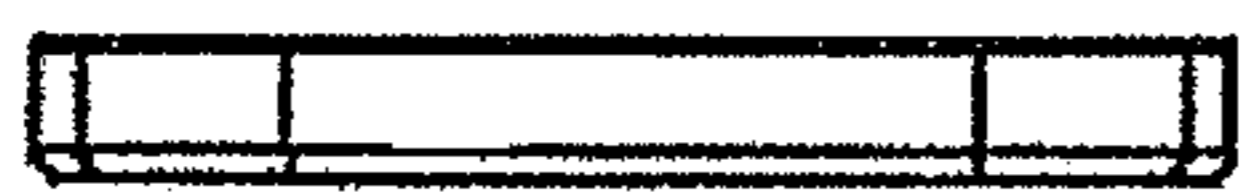

Fig. 10

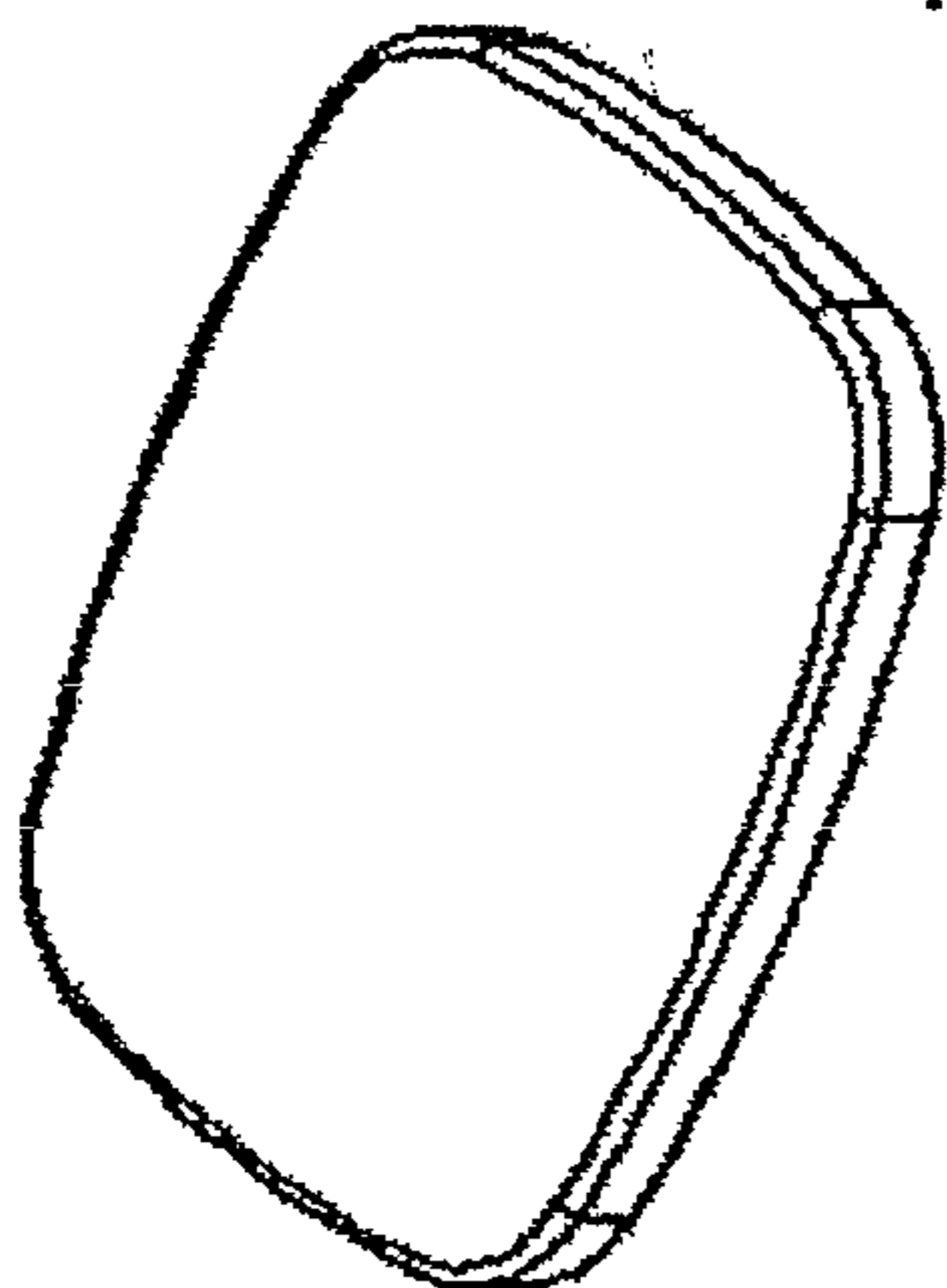

Fig. 7



Fig. 11

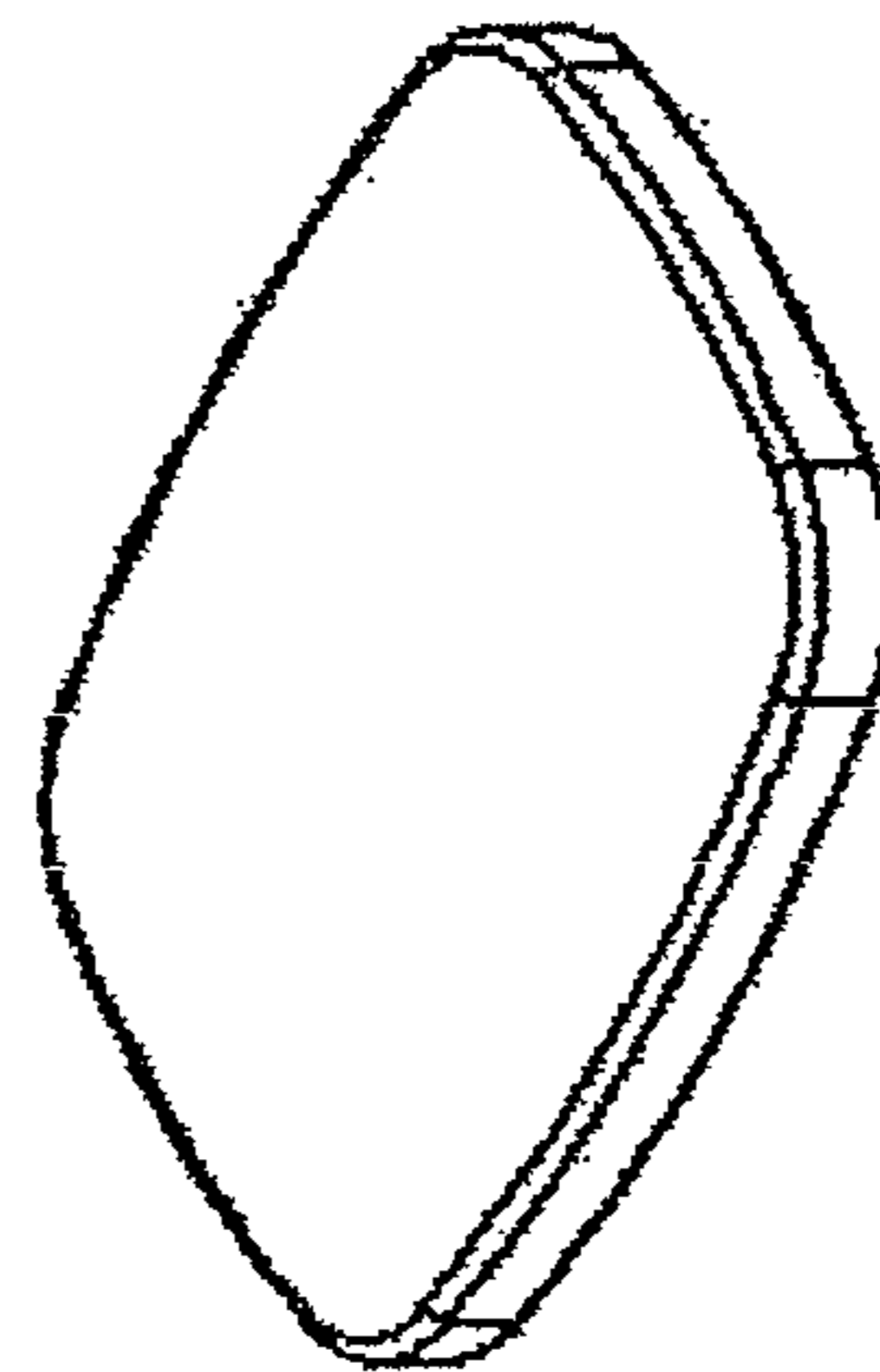

Fig. 8



Fig. 12

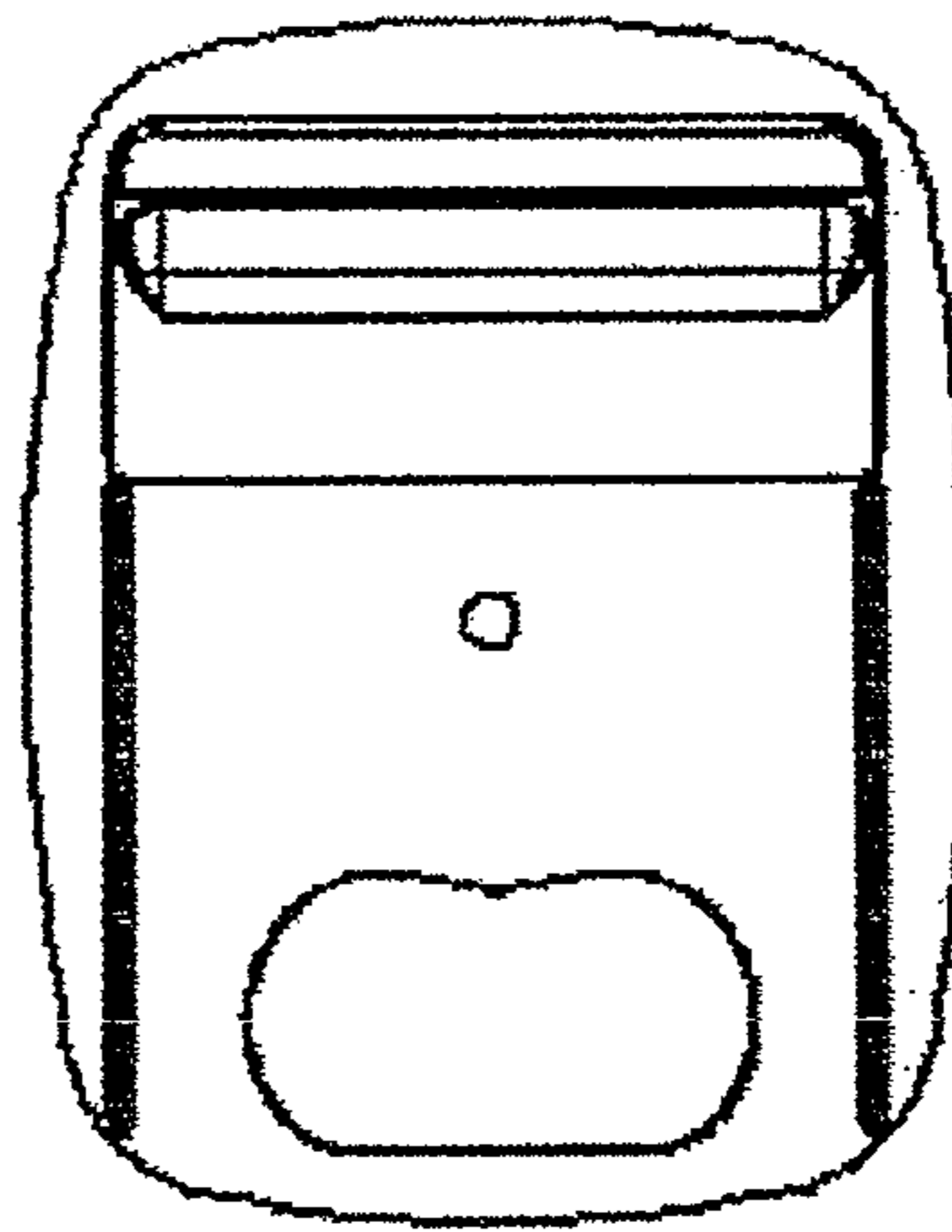

Fig. 13



Fig. 14

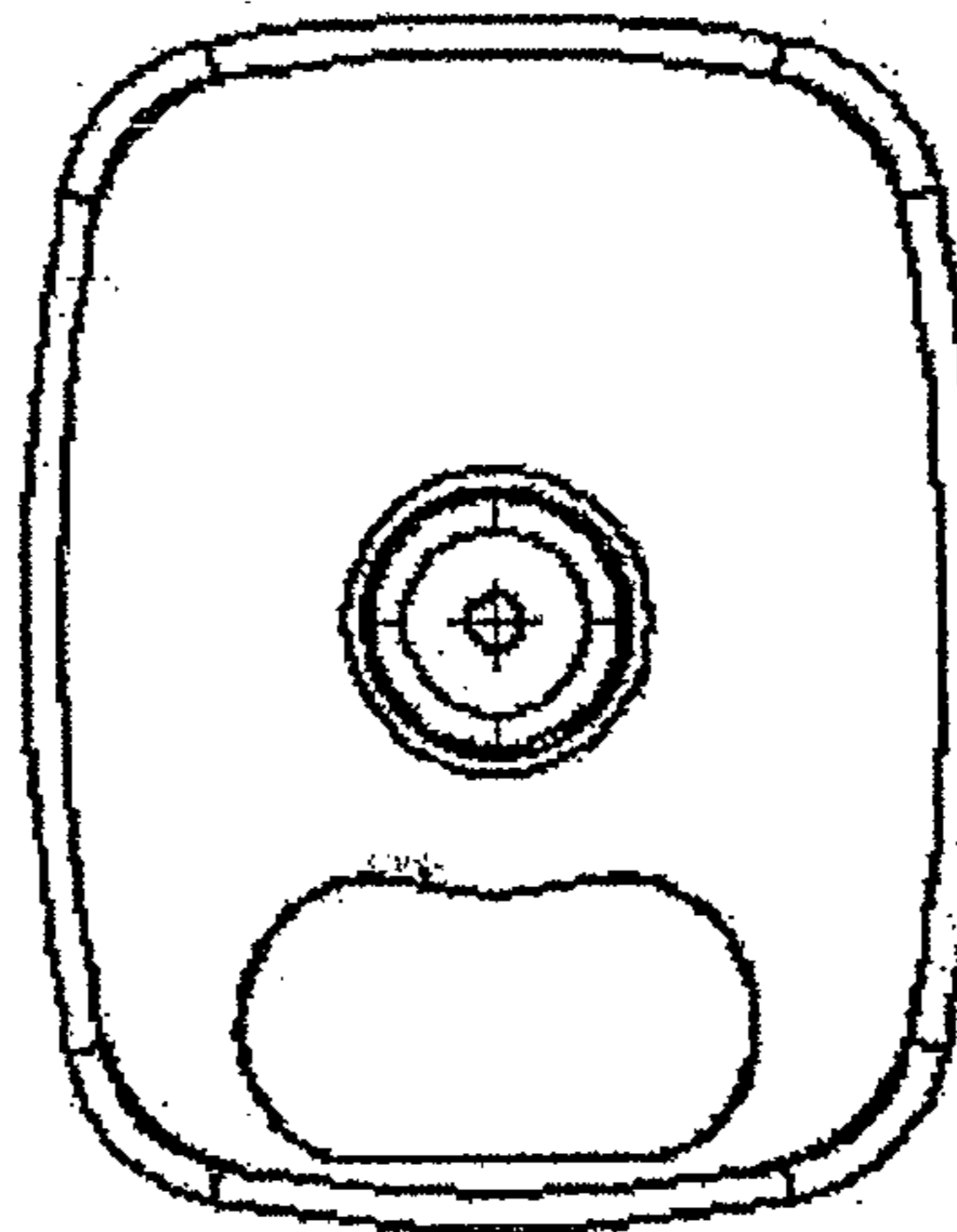

Fig. 15

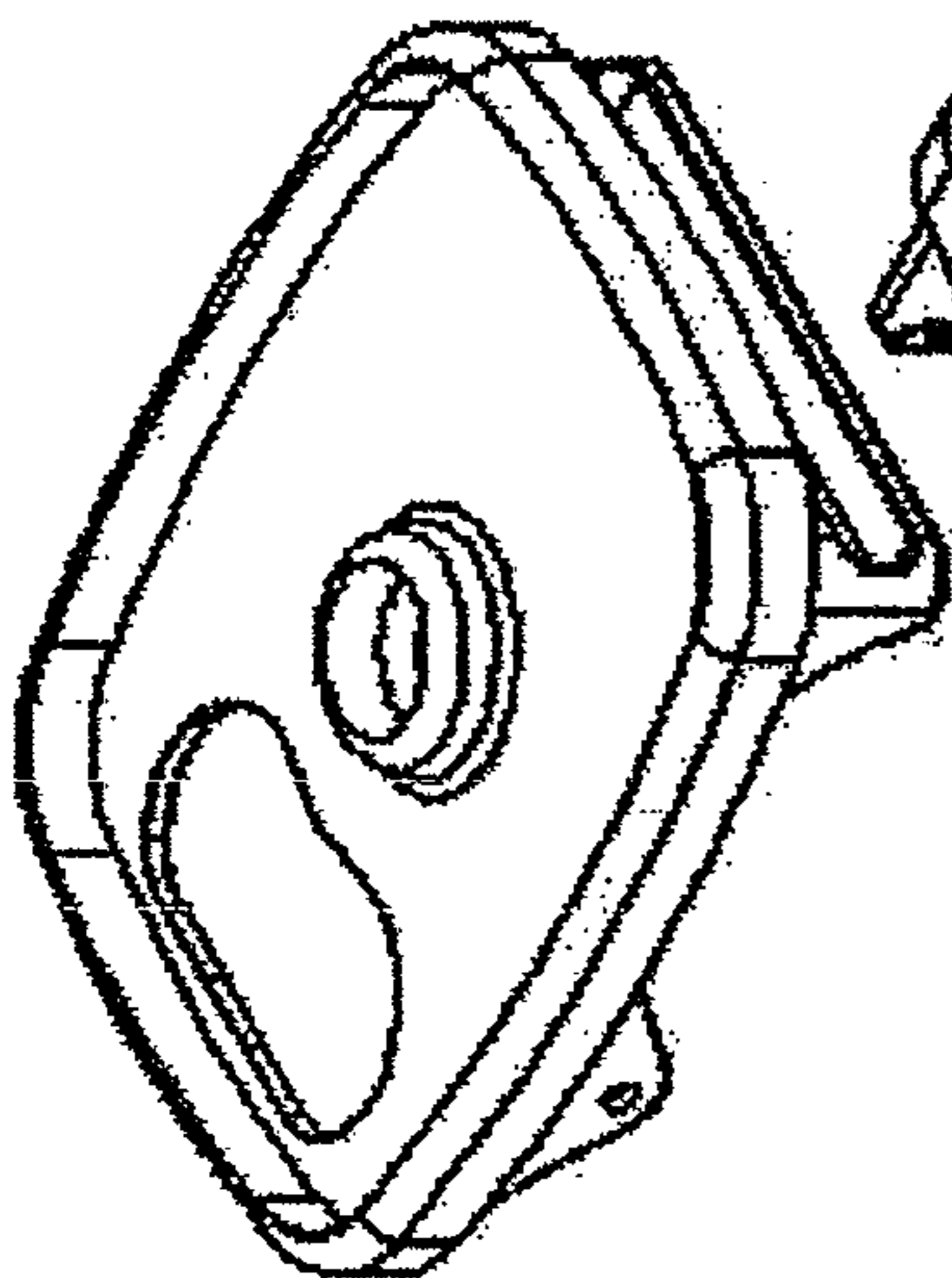

Fig. 16

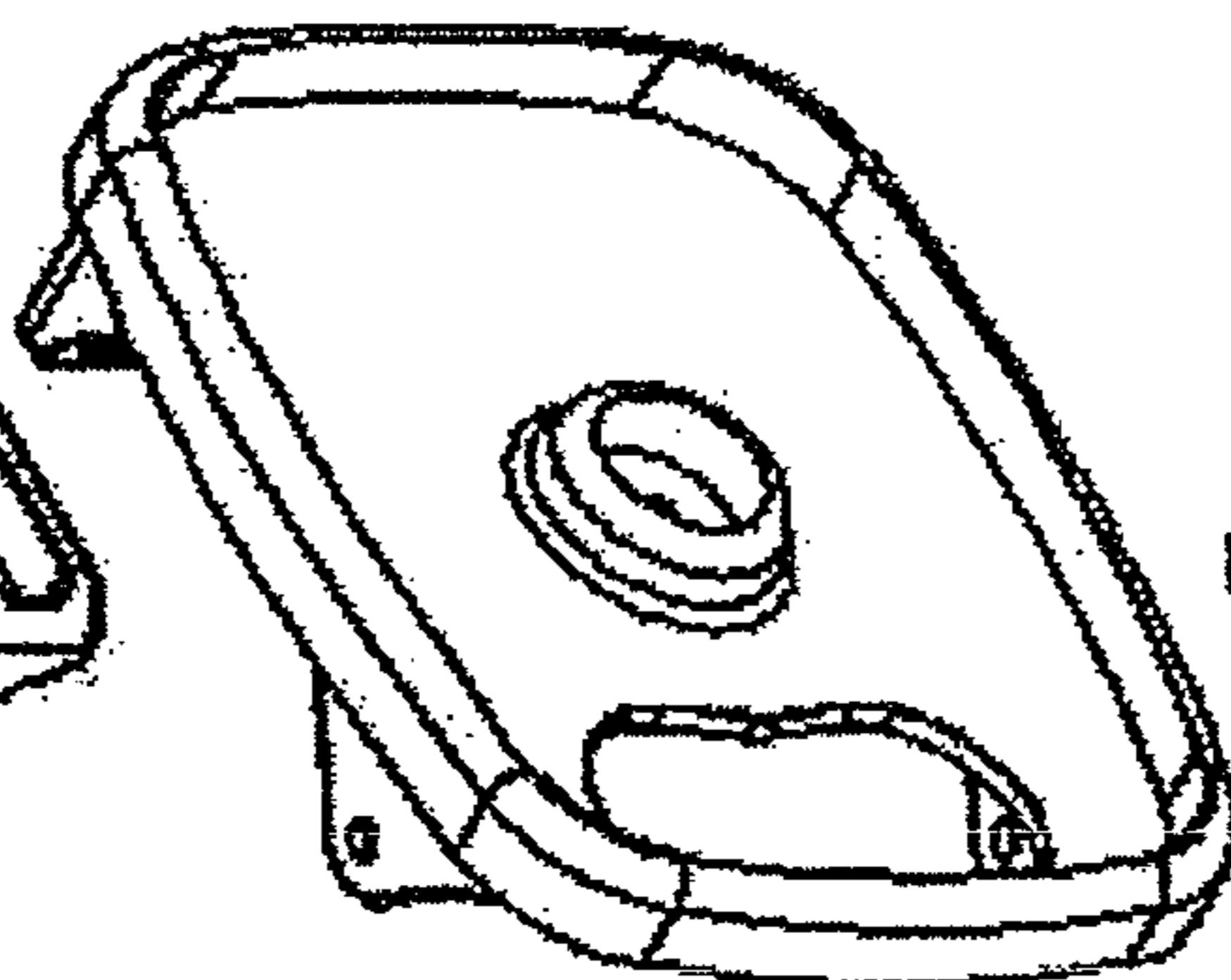

Fig. 17

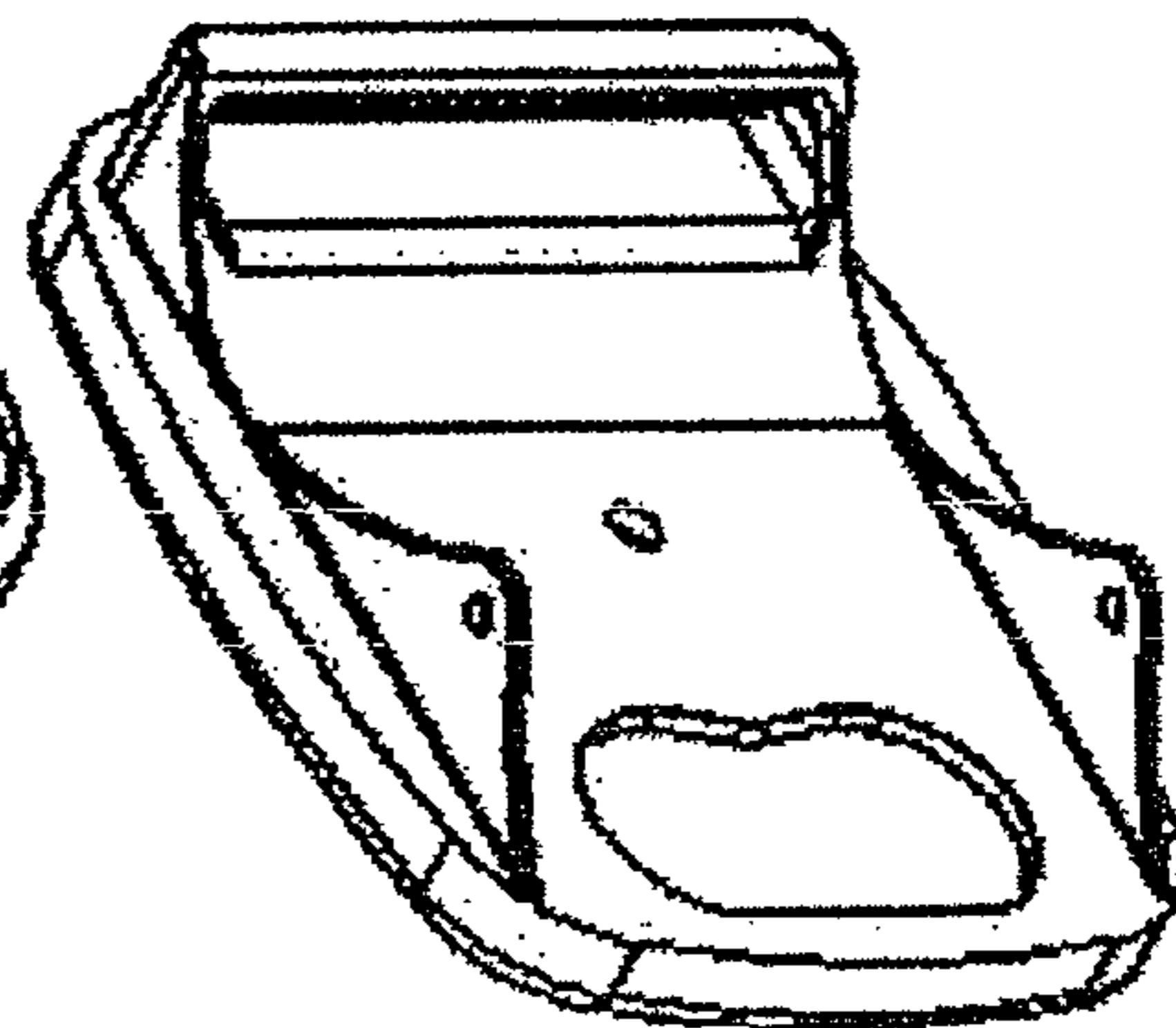

Fig. 18



Fig. 19

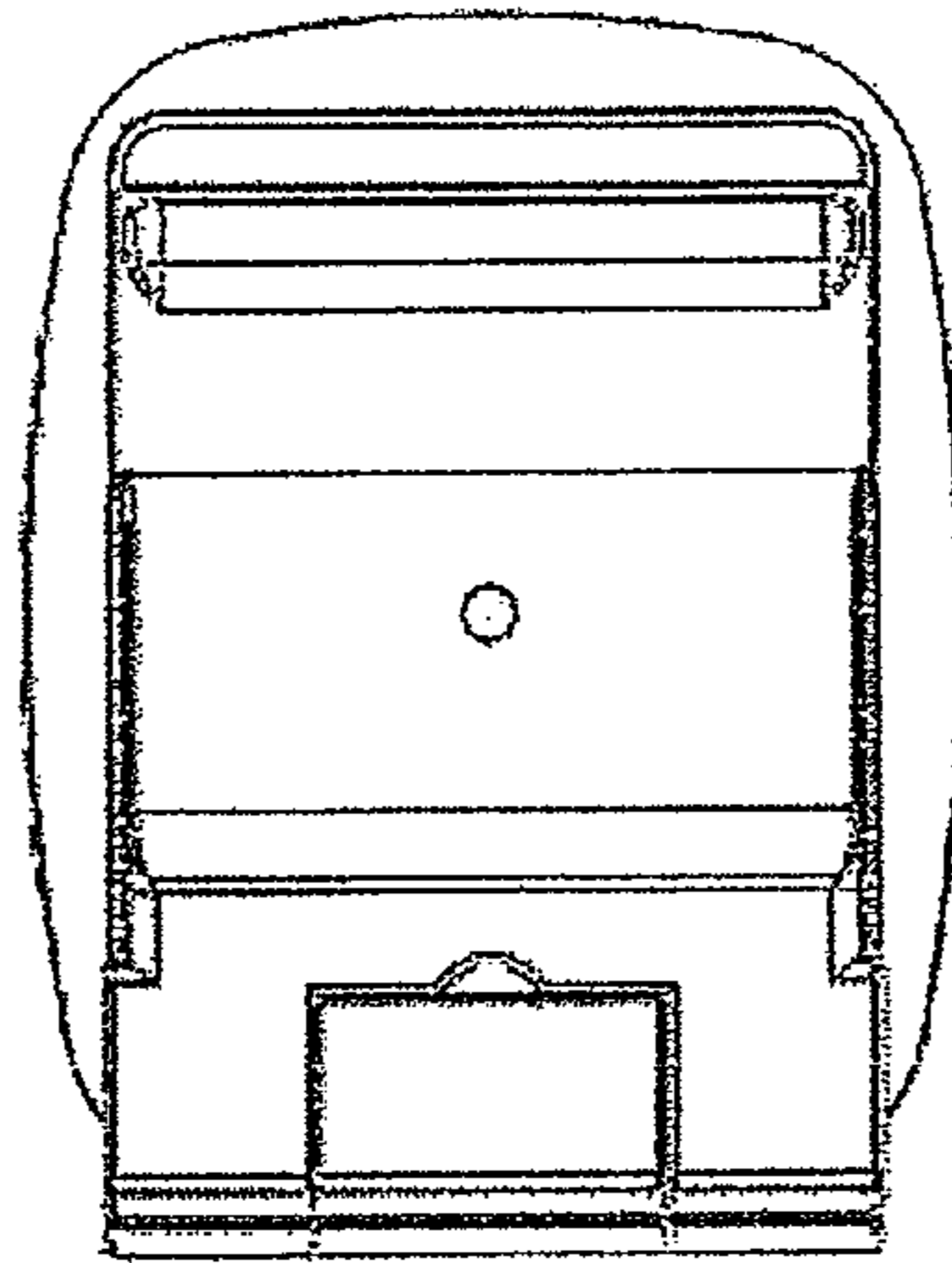

Fig. 20

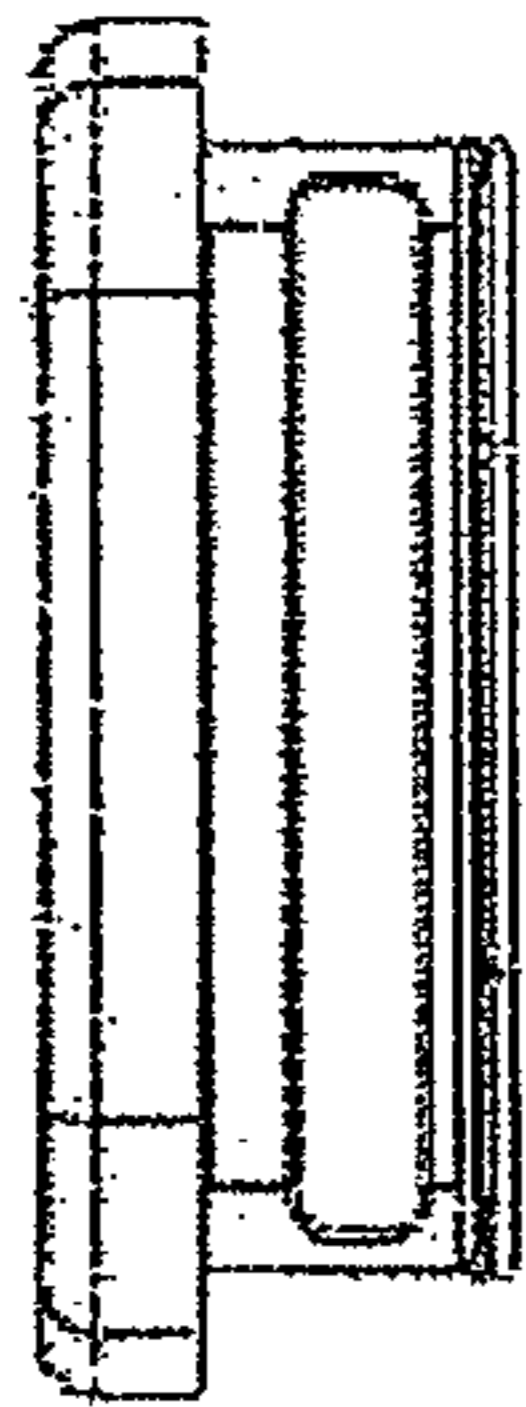

Fig. 21

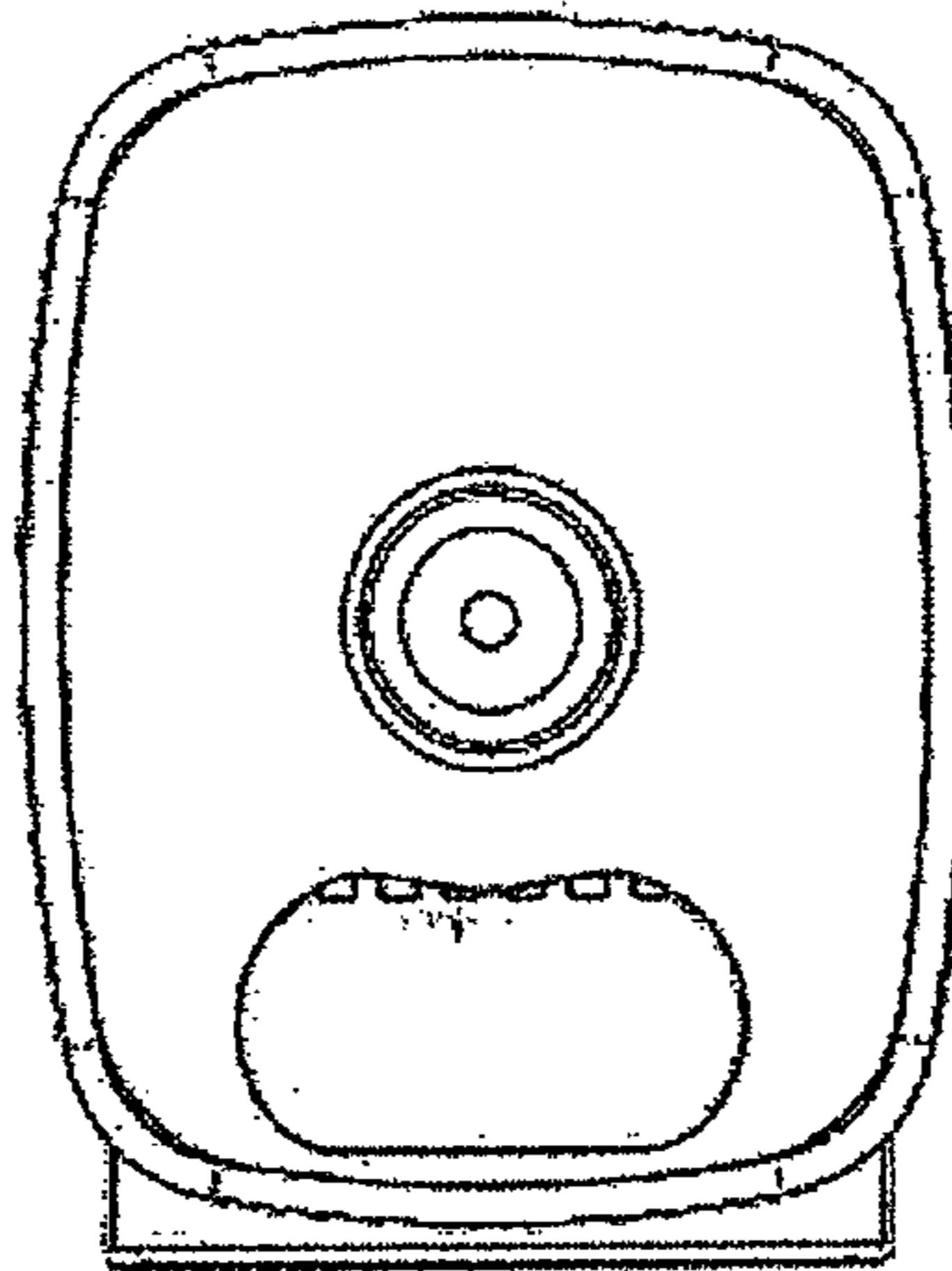

Fig. 22

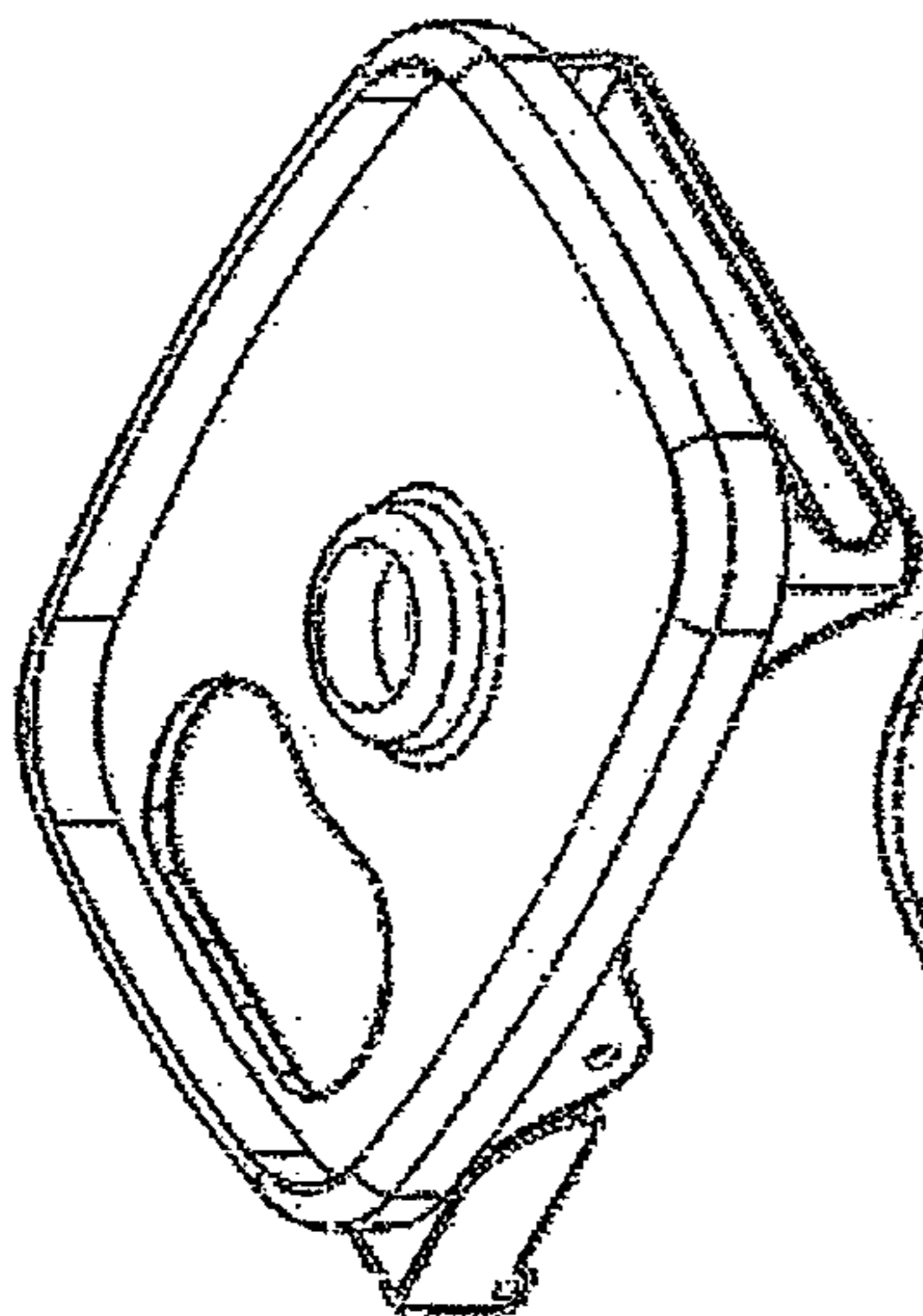

Fig. 23

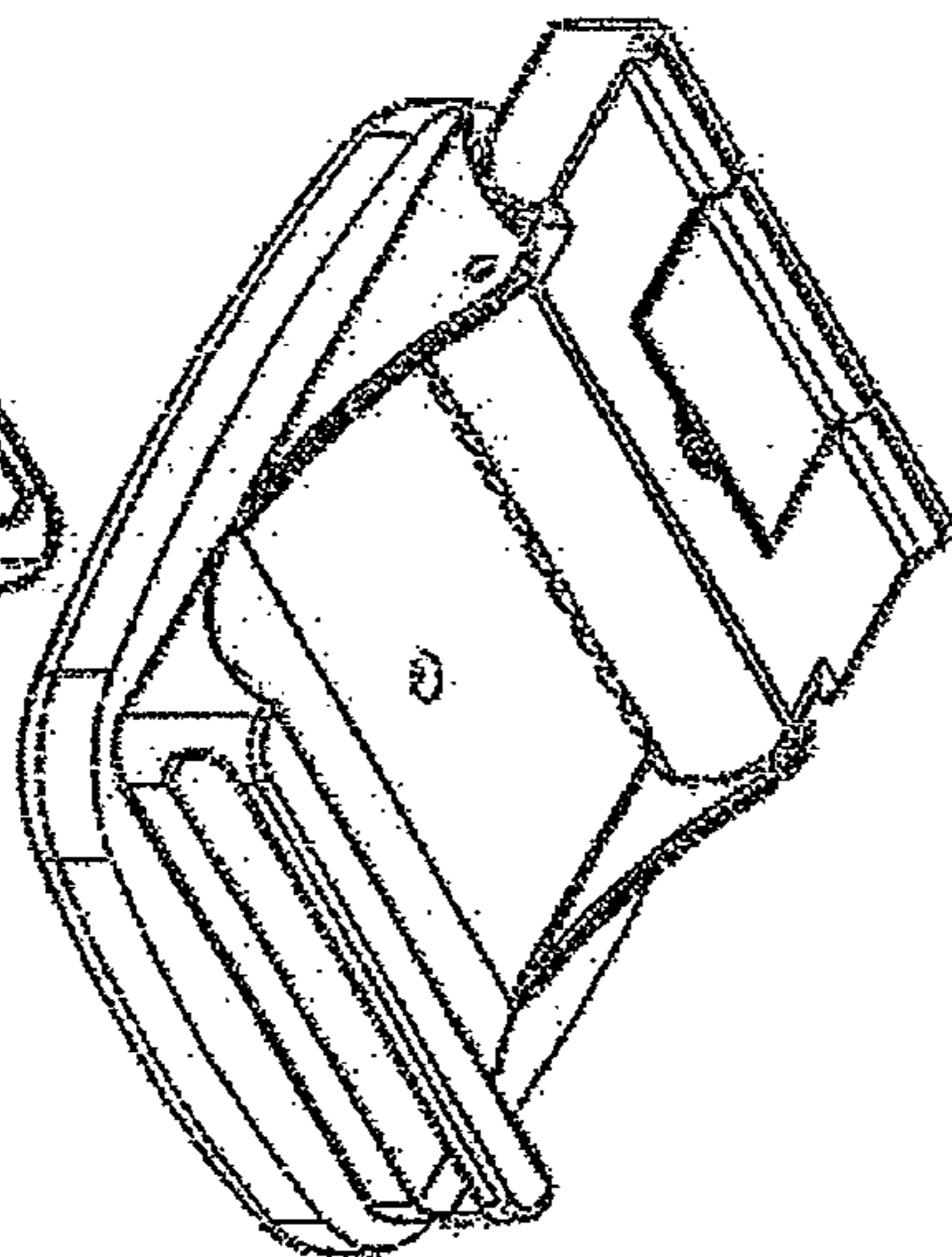

Fig. 24

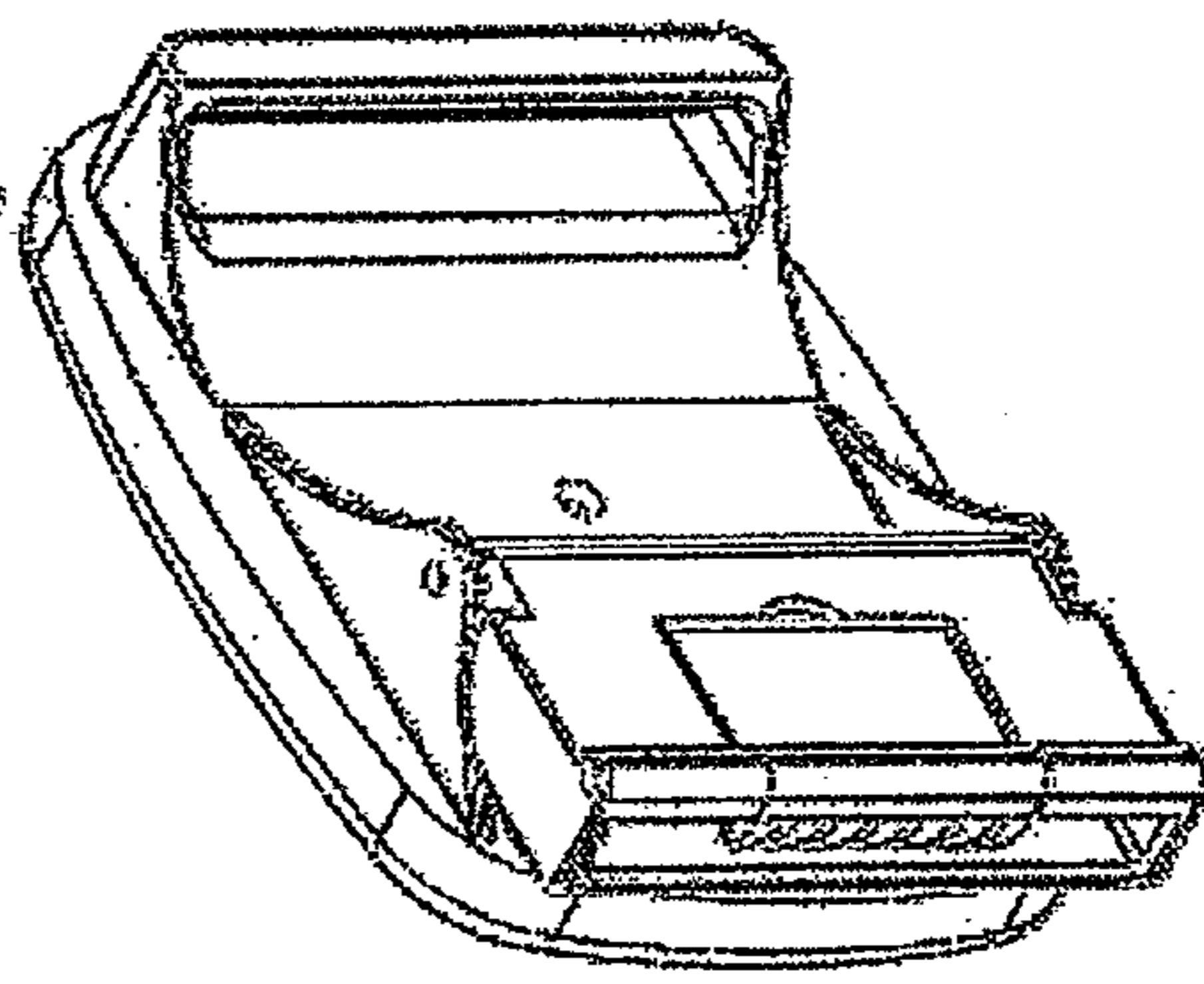

Fig. 25

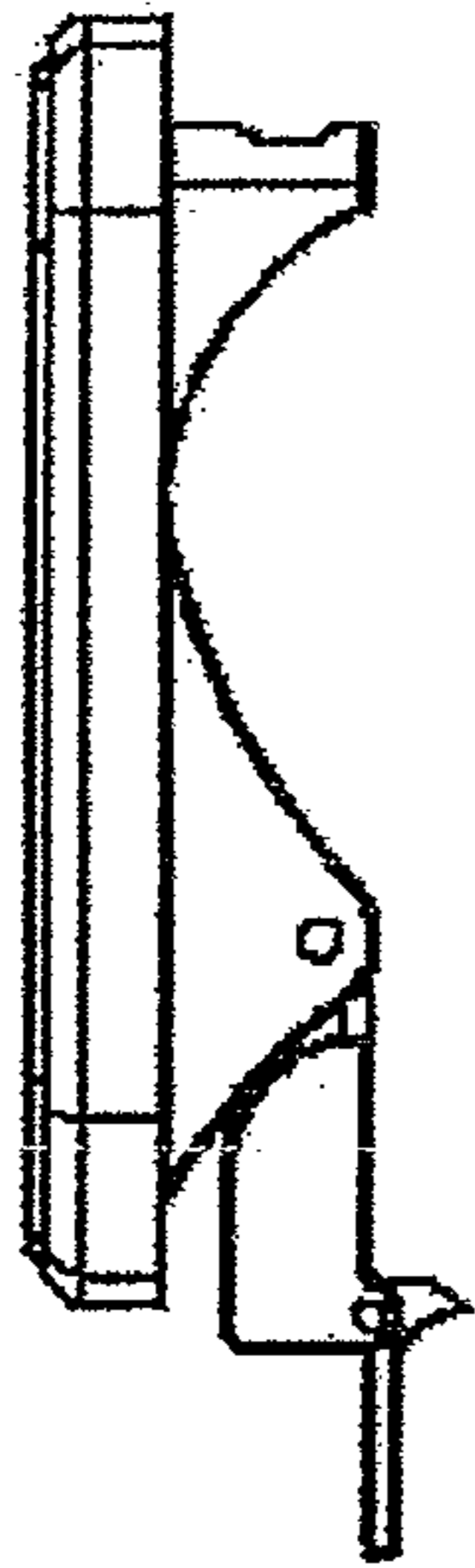

Fig. 26

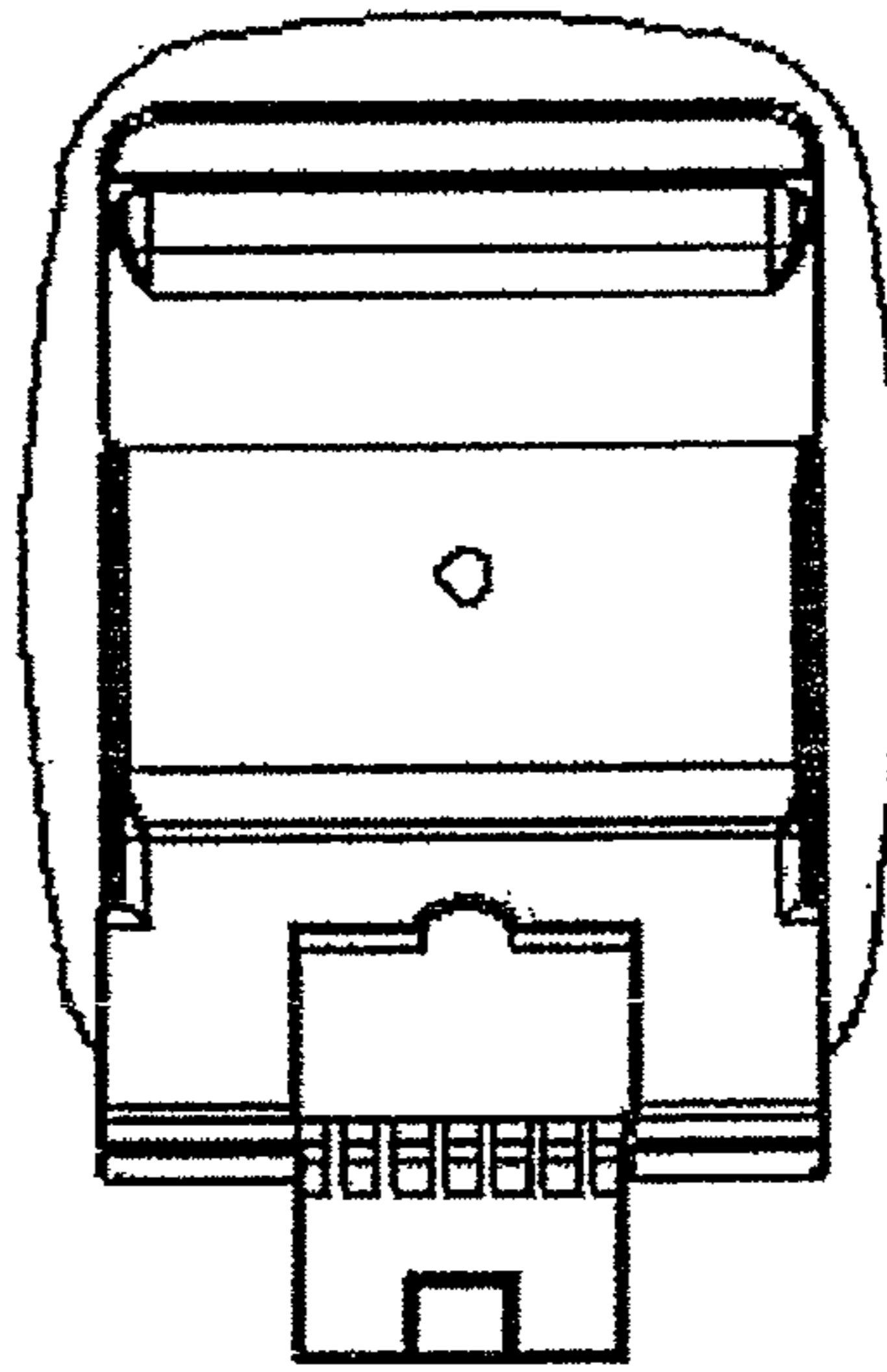

Fig. 27

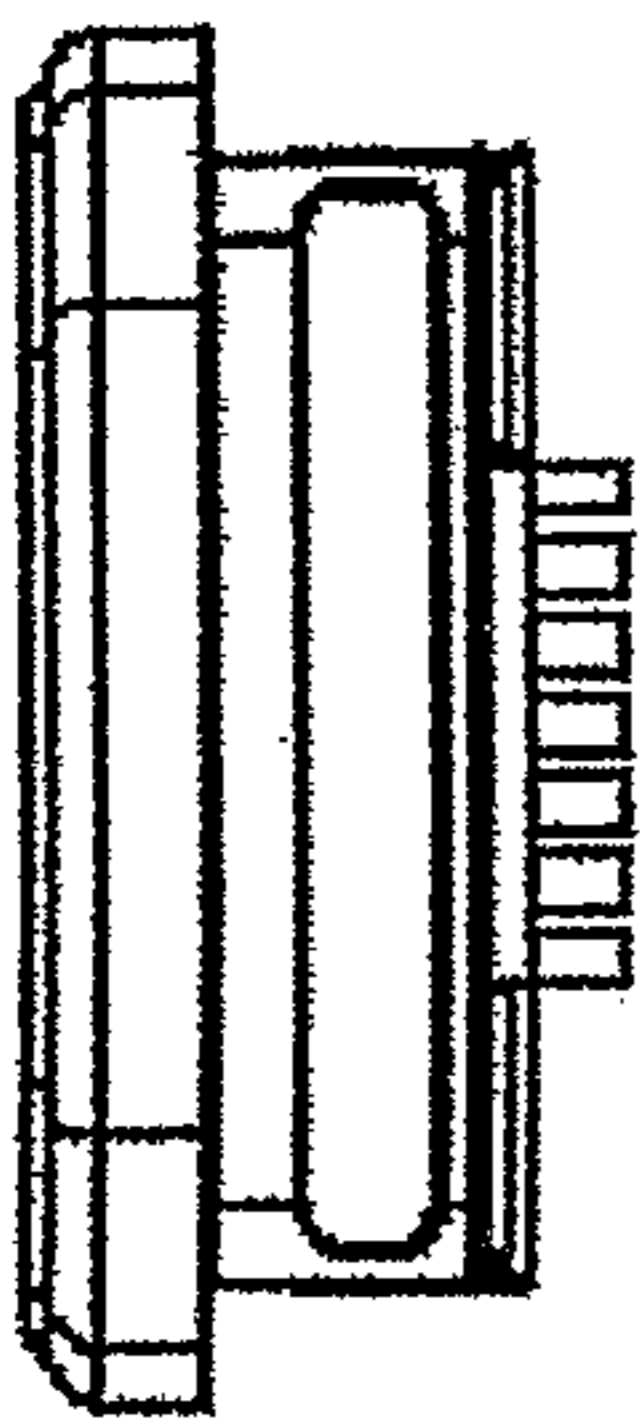

Fig. 28

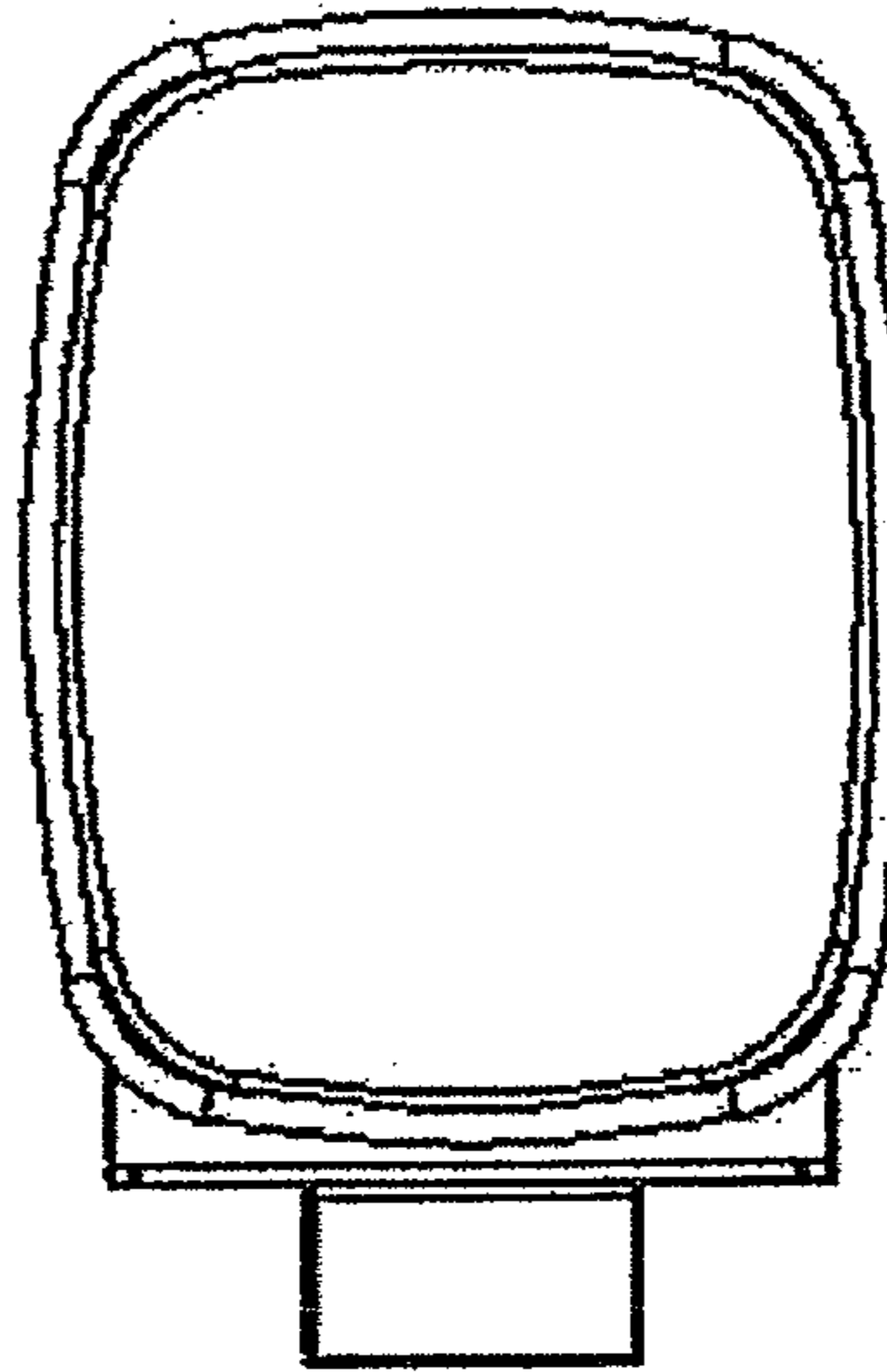

Fig. 29

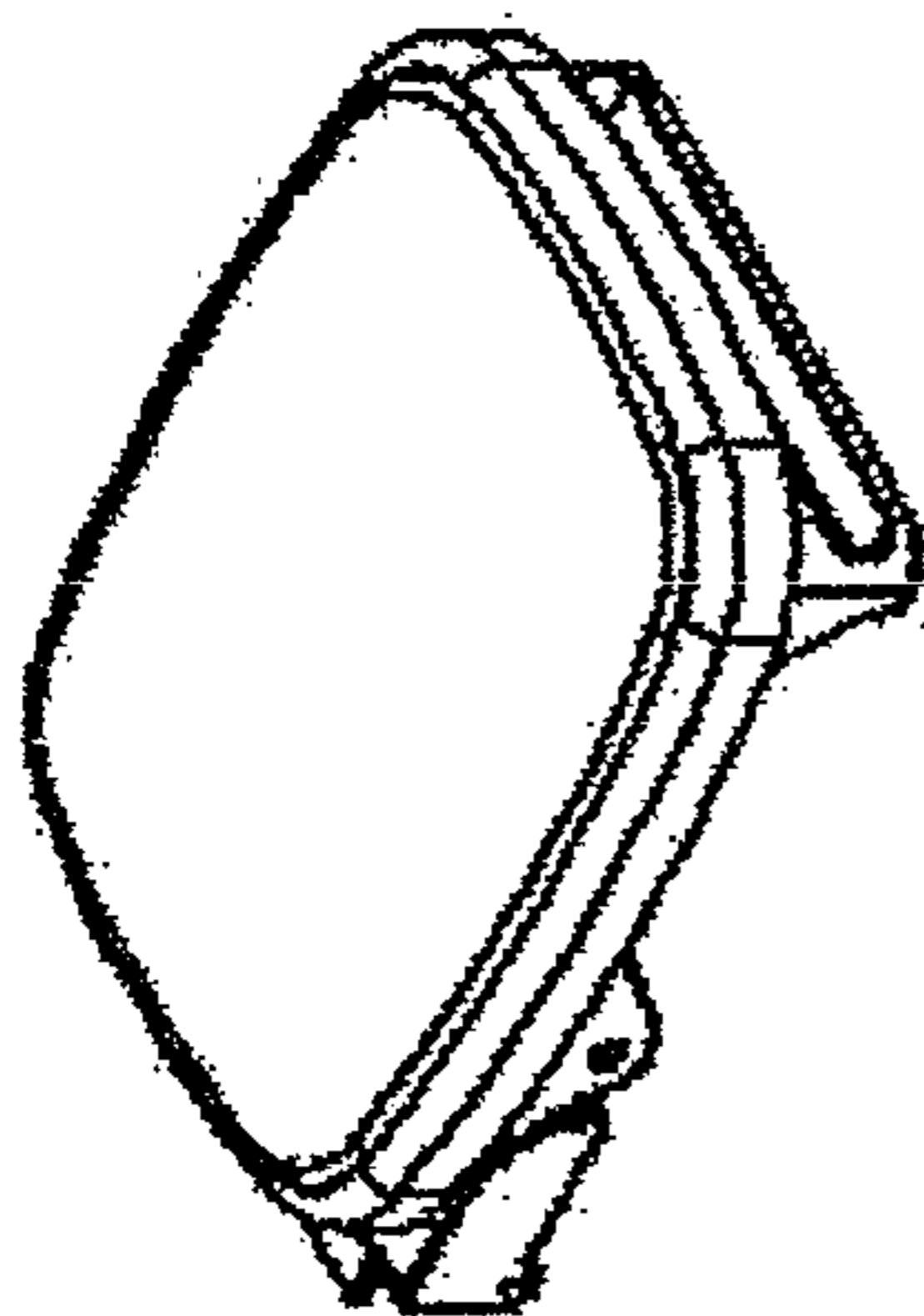

Fig. 30

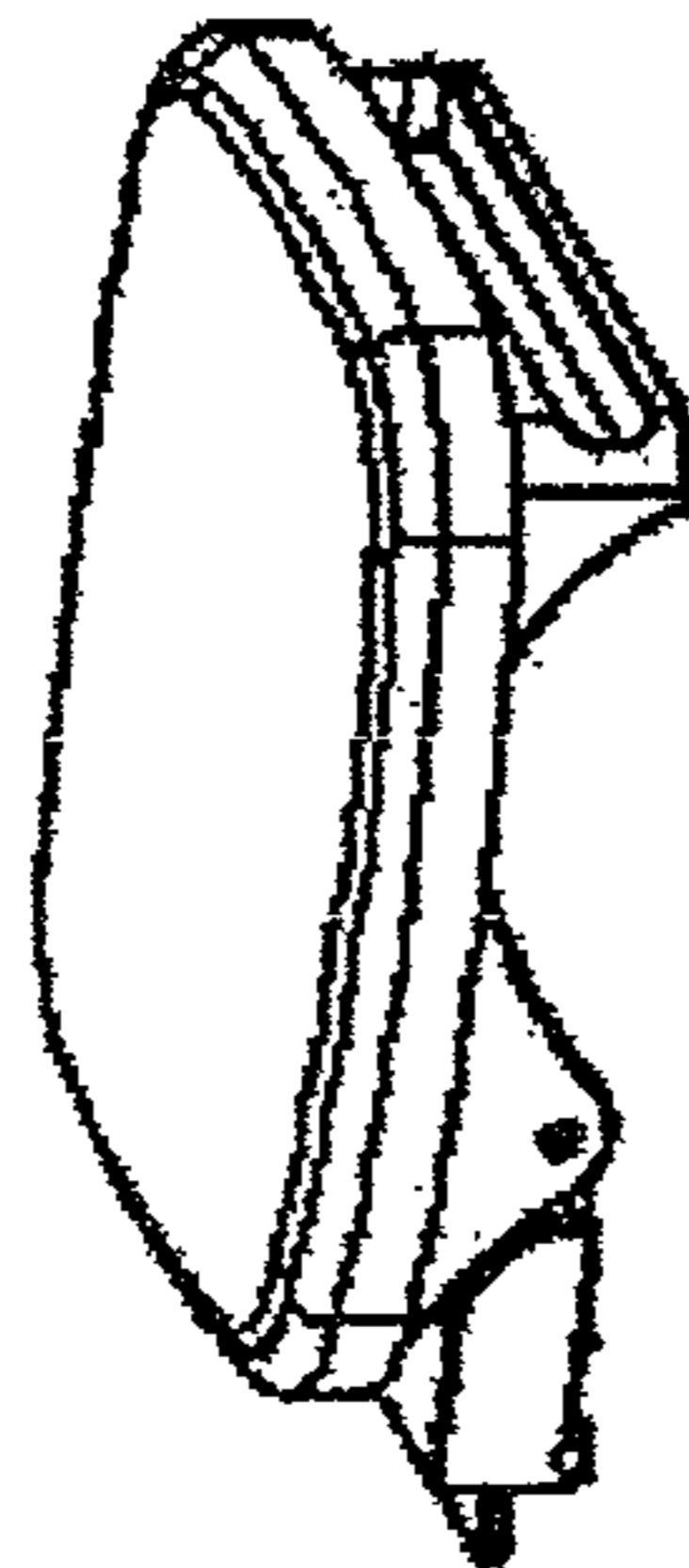

Fig. 31

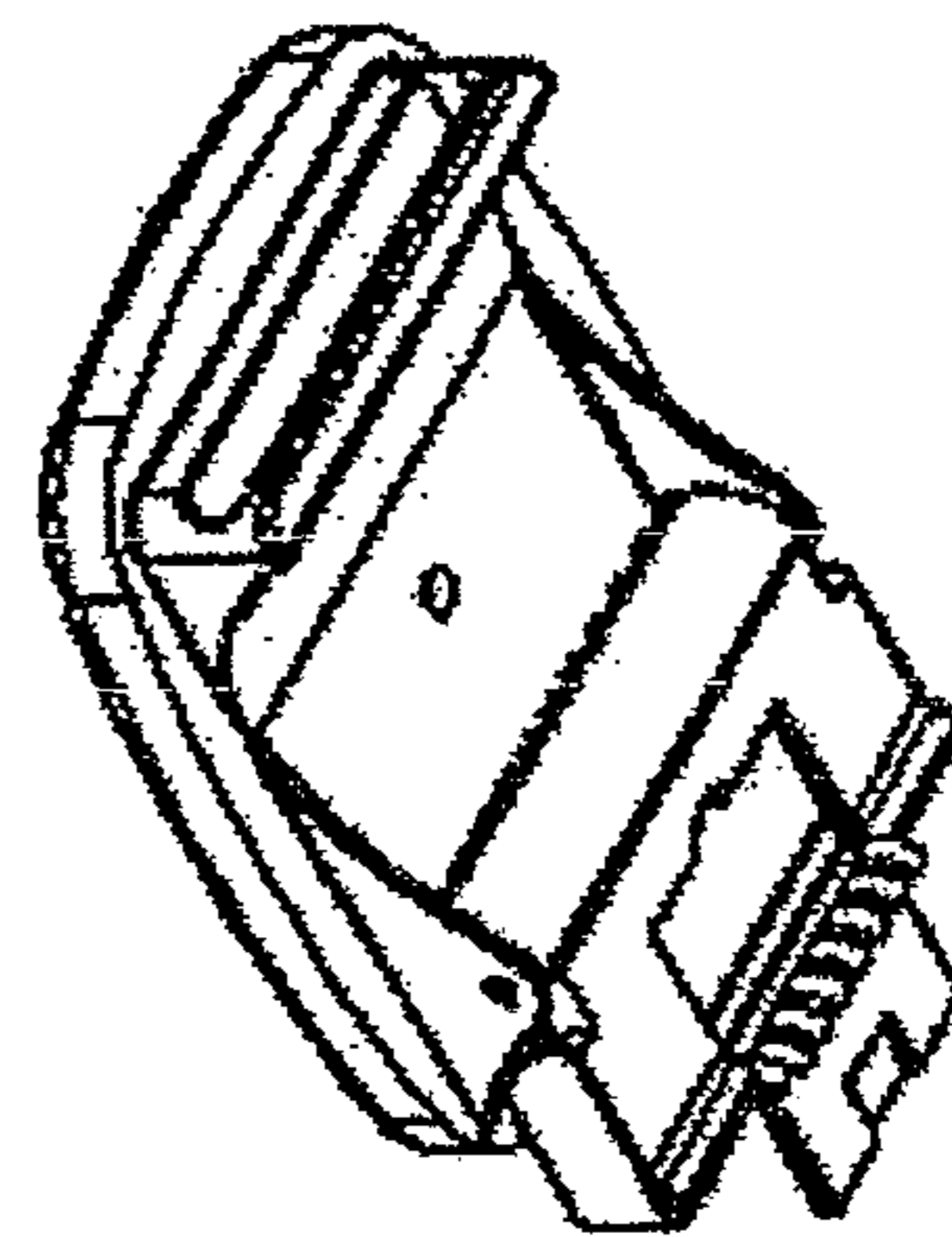

Fig. 32