



US00D631377S

(12) **United States Design Patent**
Jorst et al.

(10) **Patent No.:** **US D631,377 S**

(45) **Date of Patent:** **** *Jan. 25, 2011**

(54) **WATCH**

(75) Inventors: **Charlotte Kjolbe Jorst**, Reno, NV
(US); **Henrik Jorst**, Reno, NV (US)

(73) Assignee: **Skagen Designs, Inc.**, Reno, NV (US)

(*) Notice: This patent is subject to a terminal disclaimer.

(**) Term: **14 Years**

(21) Appl. No.: **29/301,098**

(22) Filed: **Feb. 11, 2008**

(51) **LOC (9) Cl.** **10-02**

(52) **U.S. Cl.** **D10/39**

(58) **Field of Classification Search** D10/30-39,
D10/122-132; 368/276, 281, 282, 285
See application file for complete search history.

(56) **References Cited**

U.S. PATENT DOCUMENTS

D244,916 S *	7/1977	Ueno	D10/38
D250,634 S *	12/1978	Porsche	D10/32
D270,243 S *	8/1983	Porsche	D10/30
D283,401 S *	4/1986	Lung	D10/30
D312,793 S *	12/1990	Fujiwara	D10/39
5,272,683 A *	12/1993	Jackl	368/282
D355,613 S *	2/1995	Takani et al.	D10/39
D355,615 S *	2/1995	Atagi	D10/39
D356,270 S *	3/1995	Kaneko	D10/32
D362,192 S *	9/1995	Hitter	D10/32
D389,070 S *	1/1998	Galli	D10/30

5,724,708 A *	3/1998	Bert	24/265 B
D413,530 S *	9/1999	Flury et al.	D10/32
D416,204 S *	11/1999	Hsu	D10/30
6,147,933 A *	11/2000	Bland et al.	368/80
D458,545 S *	6/2002	Modolo	D10/32
D462,623 S *	9/2002	Fujihara	D10/30
D476,905 S *	7/2003	El Kadiri	D10/30
D505,086 S *	5/2005	Fernandez	D10/39
D517,433 S *	3/2006	Jorst et al.	D10/39
D561,049 S *	2/2008	Figueiredo	D10/38
D581,811 S *	12/2008	Messmer et al.	D10/32
D583,682 S *	12/2008	Blank	D10/32
D588,472 S *	3/2009	Messmer et al.	D10/32

* cited by examiner

Primary Examiner—Lucy Lieberman

(57) **CLAIM**

We claim the ornamental design for the watch, as illustrated in the drawing figures.

DESCRIPTION

The applicant has filed design patent applications with regard to related watch designs, application Ser. No. 29/272,334, and application Ser. No. 29/293,795.

FIG. 1 is a front or top view of the watch

FIG. 2 is a side view of the right side of the watch

FIG. 3 is a side view of the left side of the watch

FIG. 4 is a back or bottom view of the watch

FIG. 5 is a perspective view of the watch; and,

FIG. 6 is an end view of the watch.

1 Claim, 2 Drawing Sheets

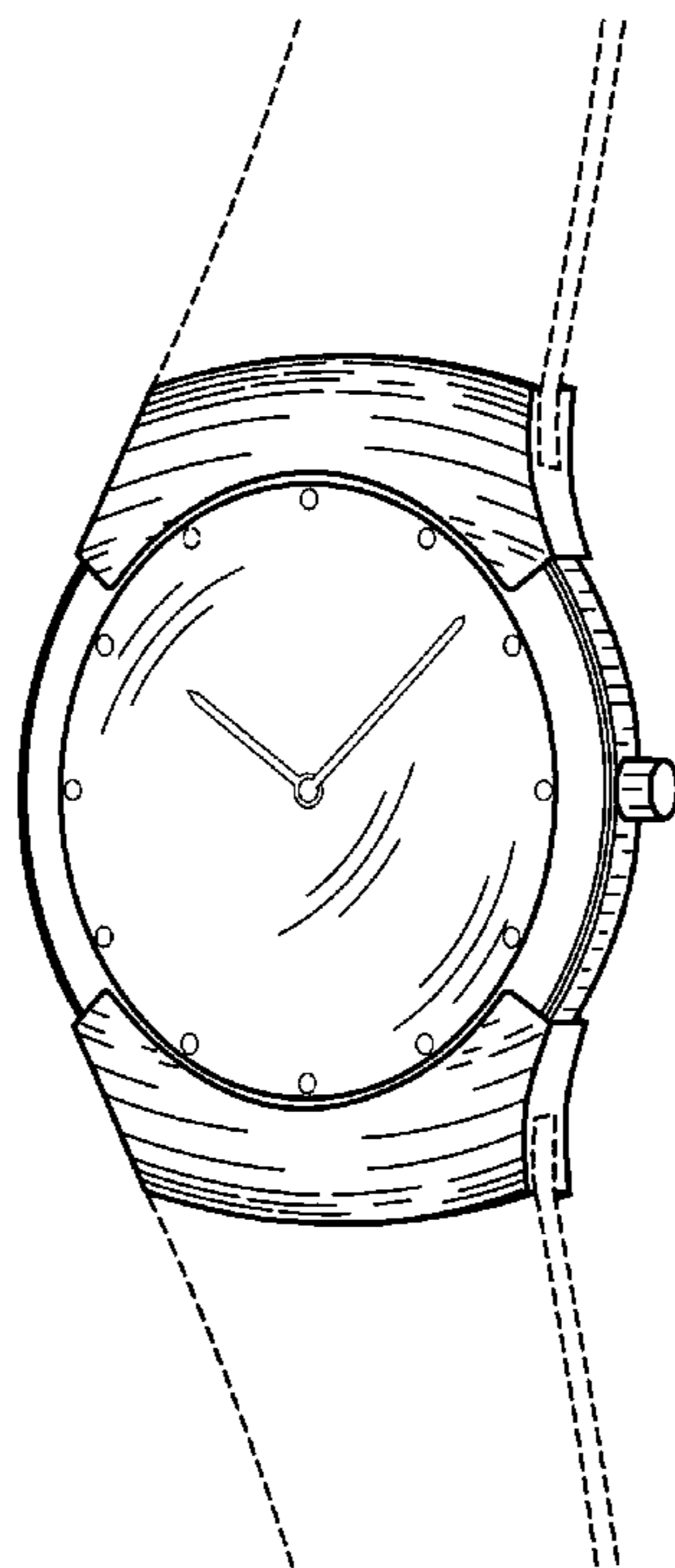

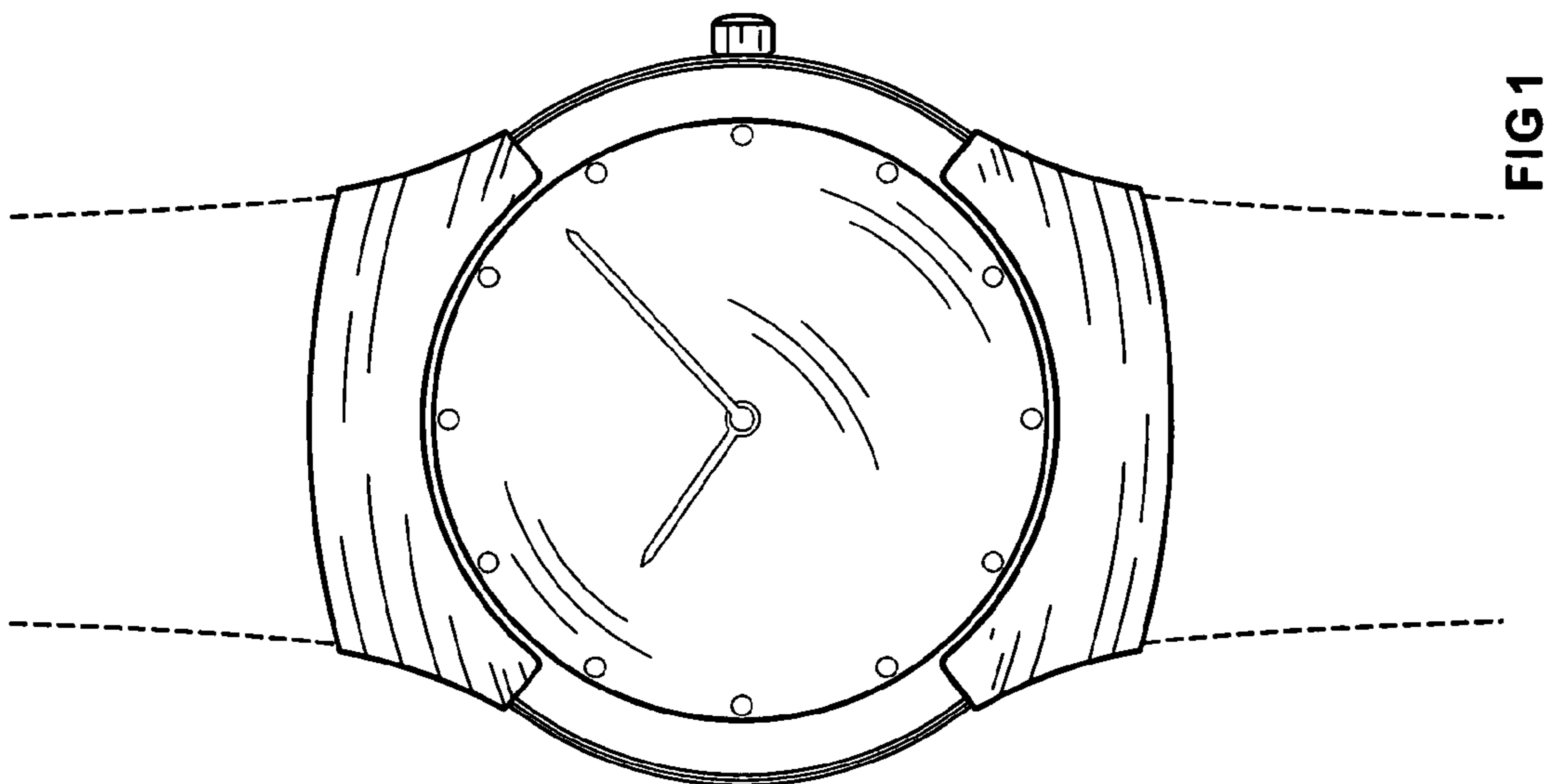
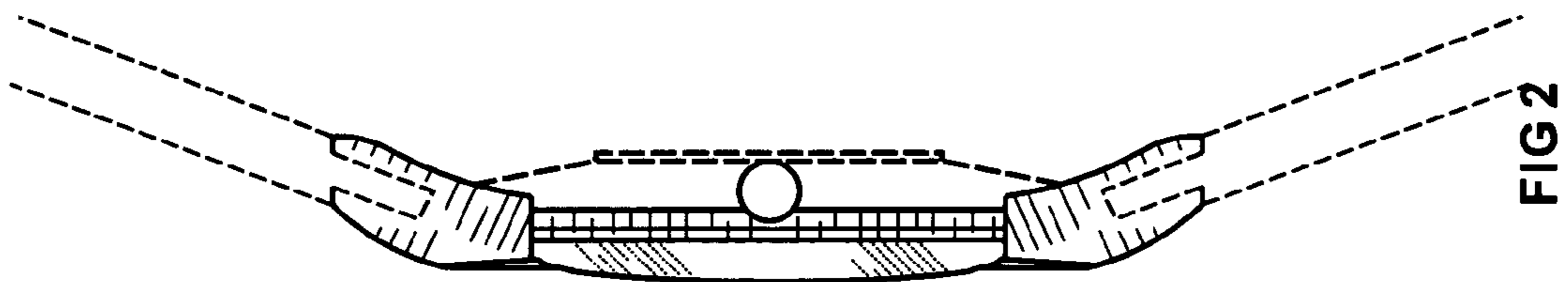
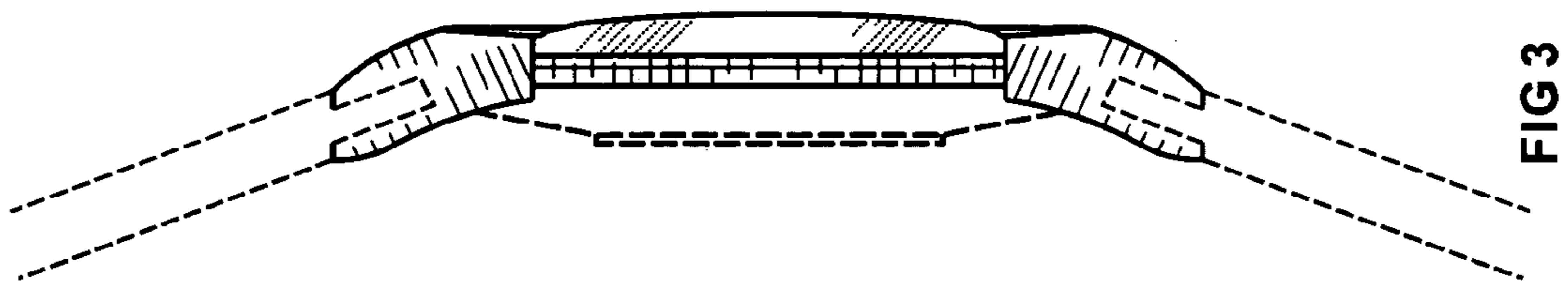
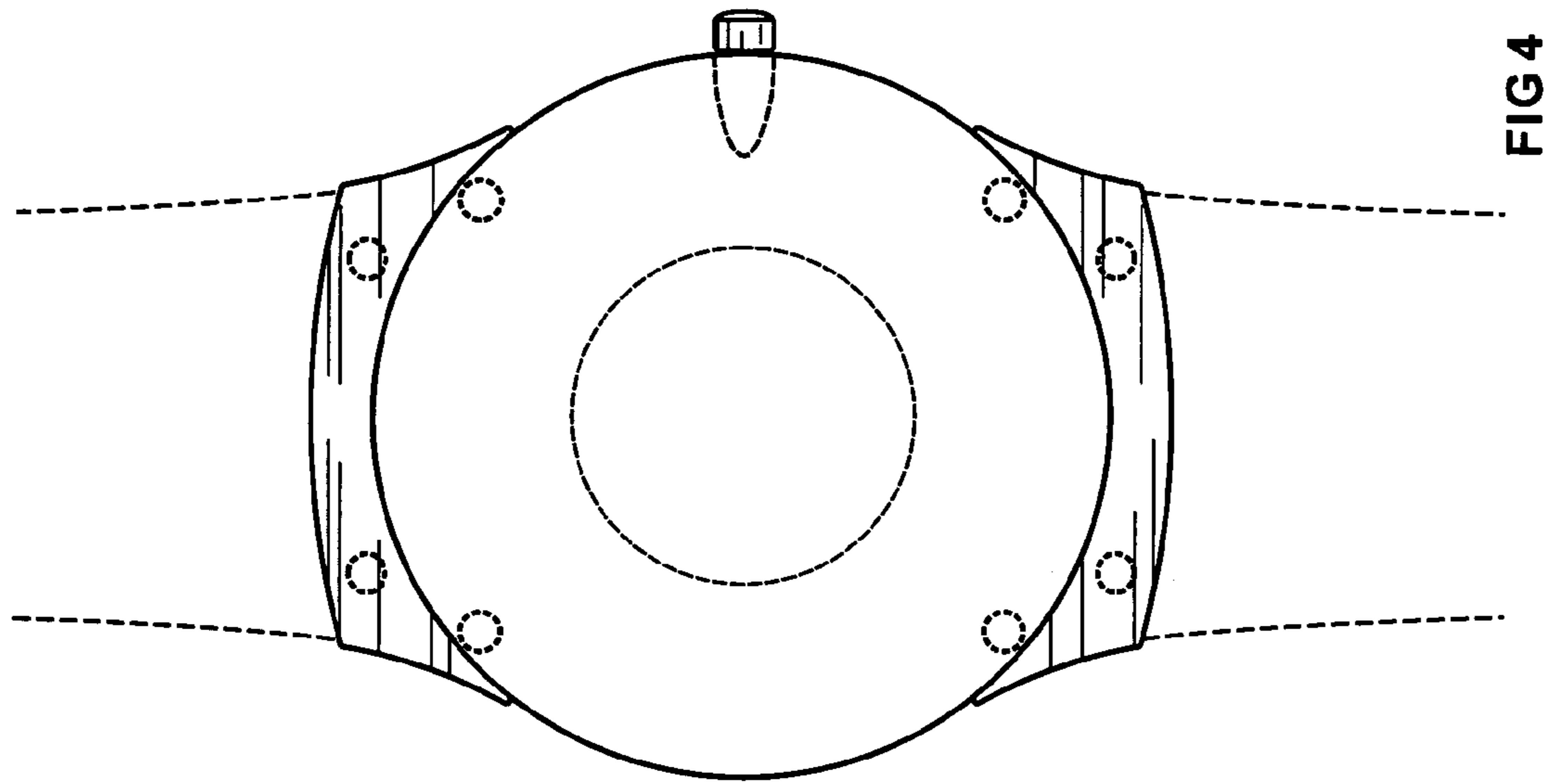

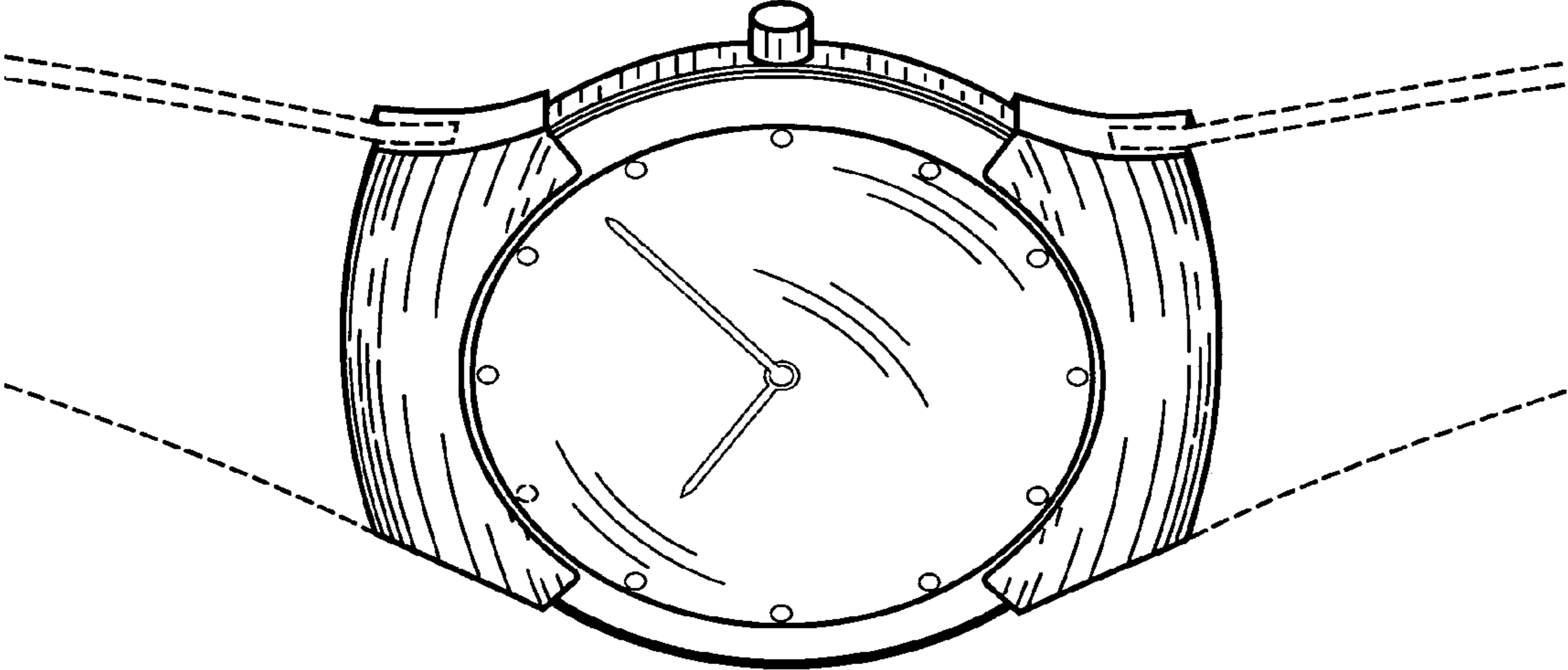

FIG 5

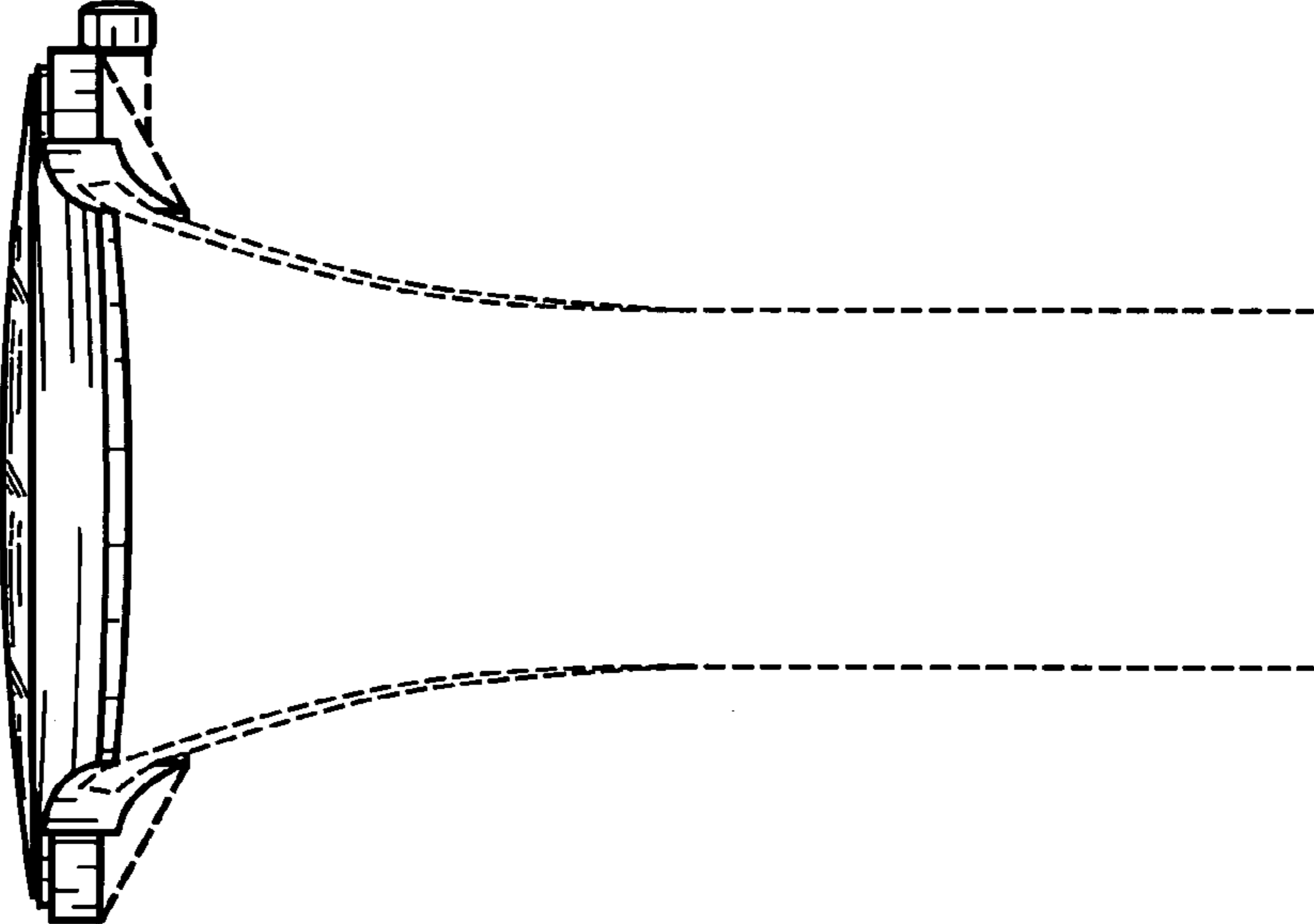

FIG 6