



US00D631359S

(12) **United States Design Patent**
Stevenson

(10) **Patent No.:** **US D631,359 S**
(45) **Date of Patent:** **** Jan. 25, 2011**

(54) **CONTAINER FOR BEVERAGE**

D579,335 S 10/2008 Wong et al.
D584,953 S 1/2009 Rica

(76) **Inventor:** **Erynn L. Stevenson**, 817 Evans St.,
Sacramento, CA (US) 95838

OTHER PUBLICATIONS

(**) **Term:** **14 Years**

WWW.RUMRECIPES.INFO, Derailer Recipe, internet, as of Dec. 30, 2009.

(21) **Appl. No.:** **29/353,102**

WWW.DRINKSMIXER.COM, Bacardi Limon Rum short-drink recipes, internet, as of Sep. 14, 2008.

(22) **Filed:** **Dec. 31, 2009**

WWW.GIGGLEPARTY.COM, Rum recipes, internet, as of Dec. 30, 2009.

(51) **LOC (9) Cl.** **09-01**

WWW.IDRINK.COM, Gummi Berry Juice Drink Recipe, internet, as of Dec. 30, 2009.

(52) **U.S. Cl.** **D9/531**

WWW.DRINK-RECIPE.US, Tag—Sprite&Soda, internet, as of Dec. 30, 2009.

(58) **Field of Classification Search** D9/500,
D9/516, 522, 528, 530, 531, 537, 539, 540,
D9/542, 543, 544, 545, 549; D7/510; 215/382–385,
215/395, 396, 398

* cited by examiner

See application file for complete search history.

Primary Examiner—Shanda C Hill

(56) **References Cited**

(57) **CLAIM**

U.S. PATENT DOCUMENTS

The ornamental design for a container for beverage, as shown and described.

4,393,090 A	7/1983	Coroneos	
D270,137 S *	8/1983	McDonald et al.	D9/522
4,396,817 A	8/1983	Eck et al.	
4,597,974 A	7/1986	Fonteneau et al.	
4,693,900 A	9/1987	Molinari	
4,935,259 A	6/1990	Vella	
5,106,643 A	4/1992	Laufer	
D339,744 S	9/1993	Seppala	
5,258,198 A	11/1993	Bastian et al.	
5,260,083 A	11/1993	Brain et al.	
D343,494 S	1/1994	Thorniley et al.	
D351,312 S *	10/1994	Sharon et al.	D7/510
5,356,648 A	10/1994	Kortschot	
D434,985 S	12/2000	Colonna	
D471,465 S *	3/2003	Sikra et al.	D9/531
D479,132 S	9/2003	Boutilier	
D512,316 S	12/2005	Illenberger et al.	
D545,213 S	6/2007	Werner	

DESCRIPTION

FIG. 1 is a perspective view of a container for beverage showing my new design;

FIG. 2 is a front view thereof;

FIG. 3 is a side view thereof;

FIG. 4 is an opposite side view thereof;

FIG. 5 is a top view thereof; and,

FIG. 6 is a bottom view thereof.

The broken lines shown in the drawing disclosure are for illustrative purposes only and form no part of the claimed design.

1 Claim, 5 Drawing Sheets

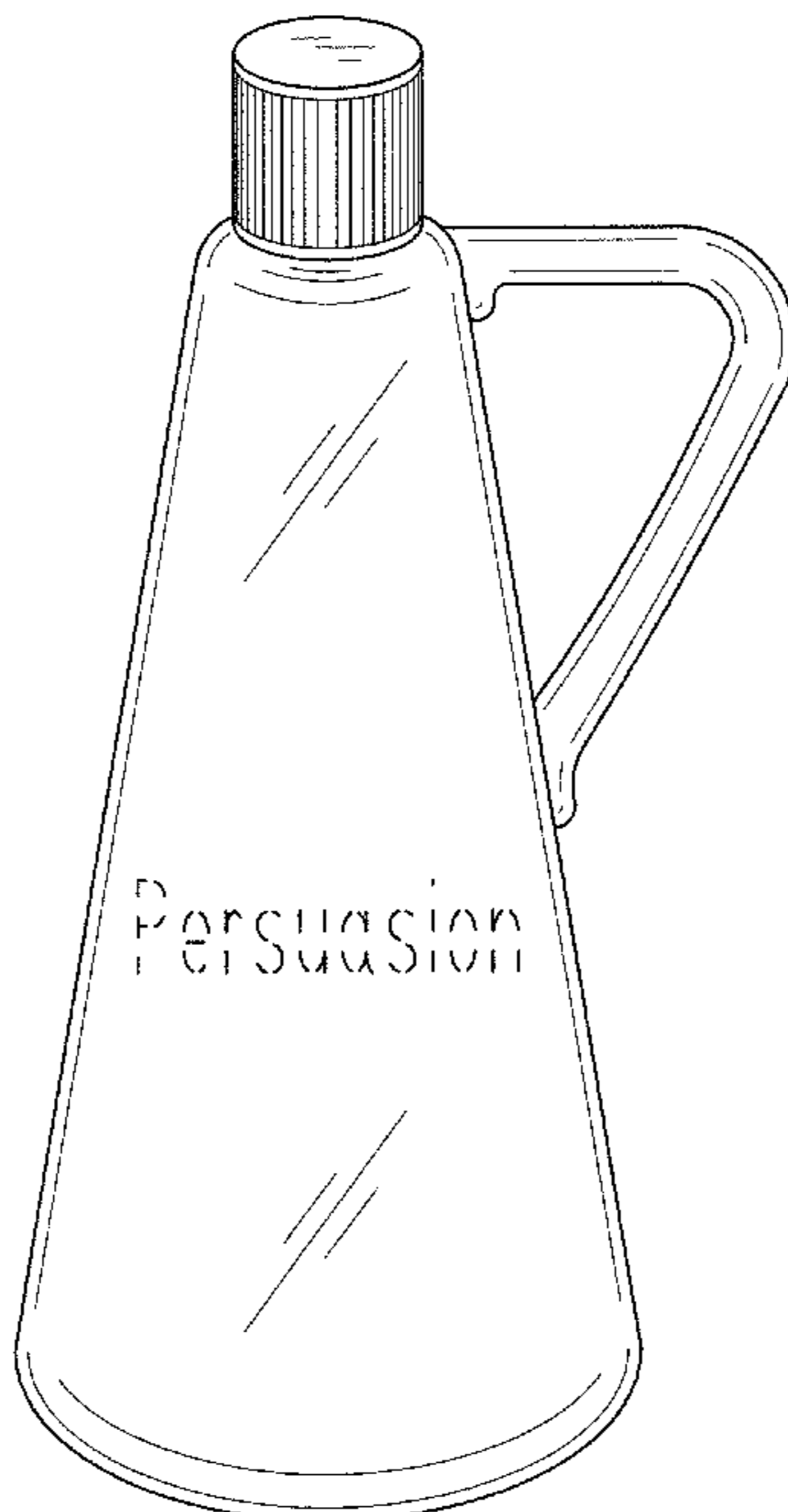

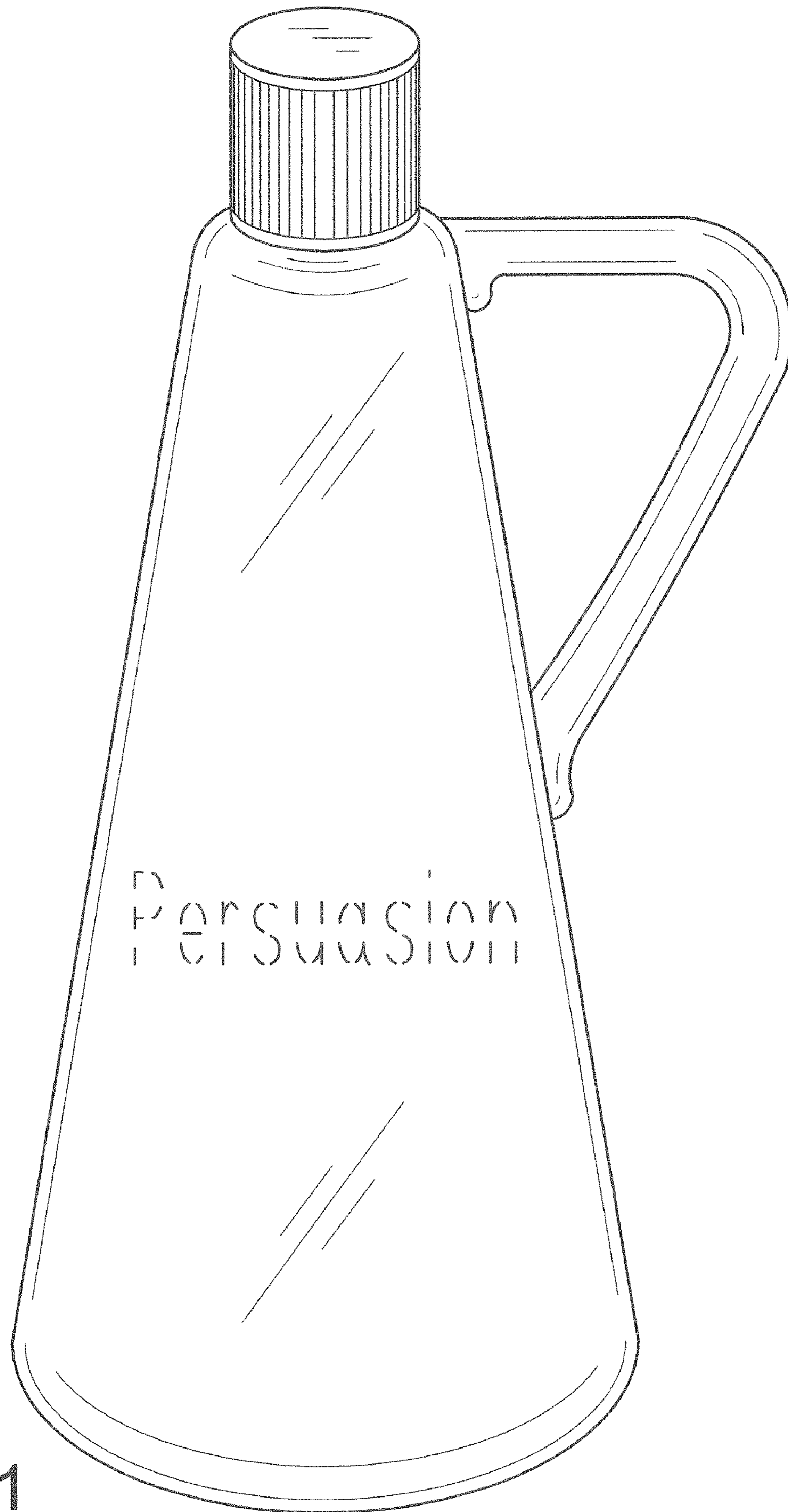

FIG. 1

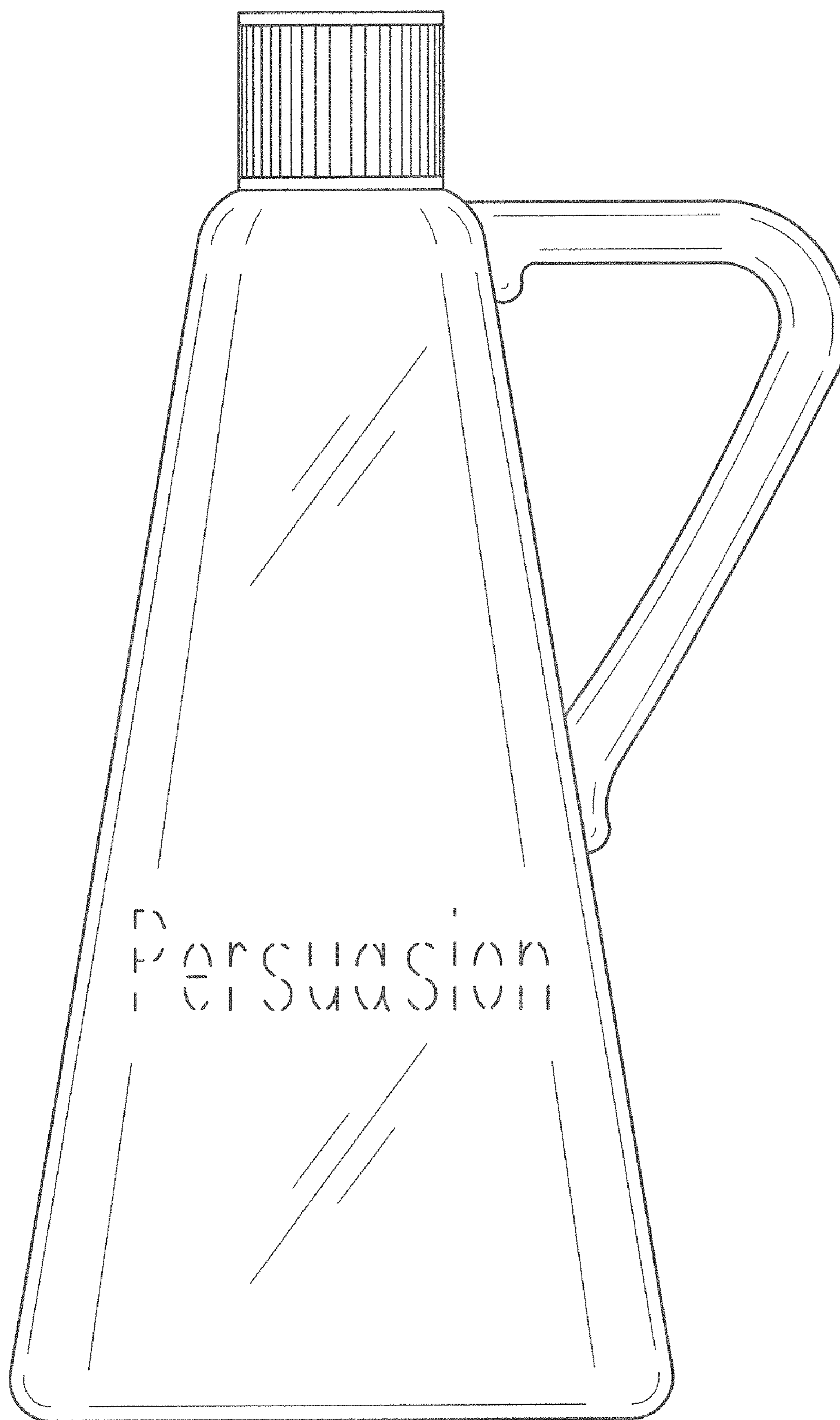

FIG. 2

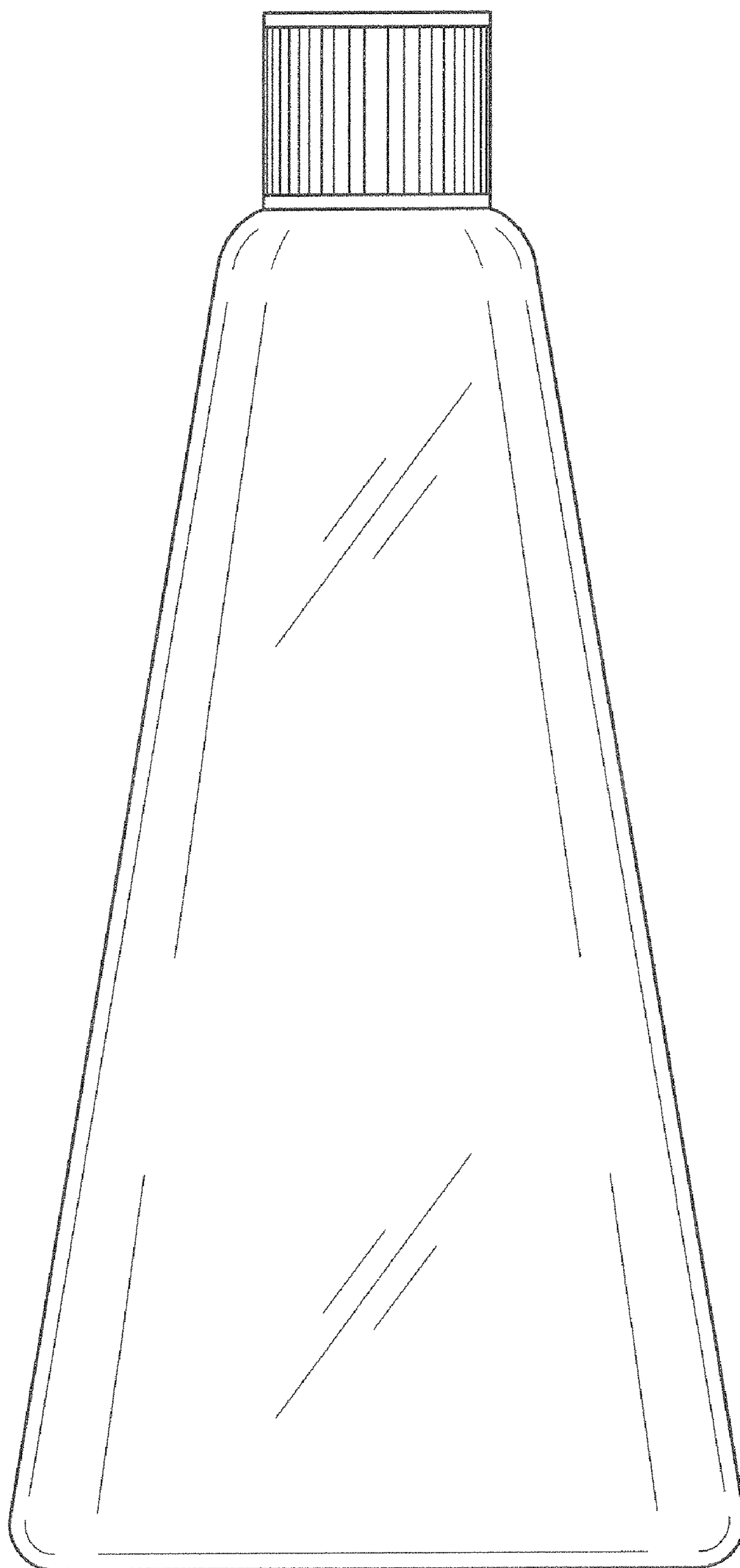

FIG. 3

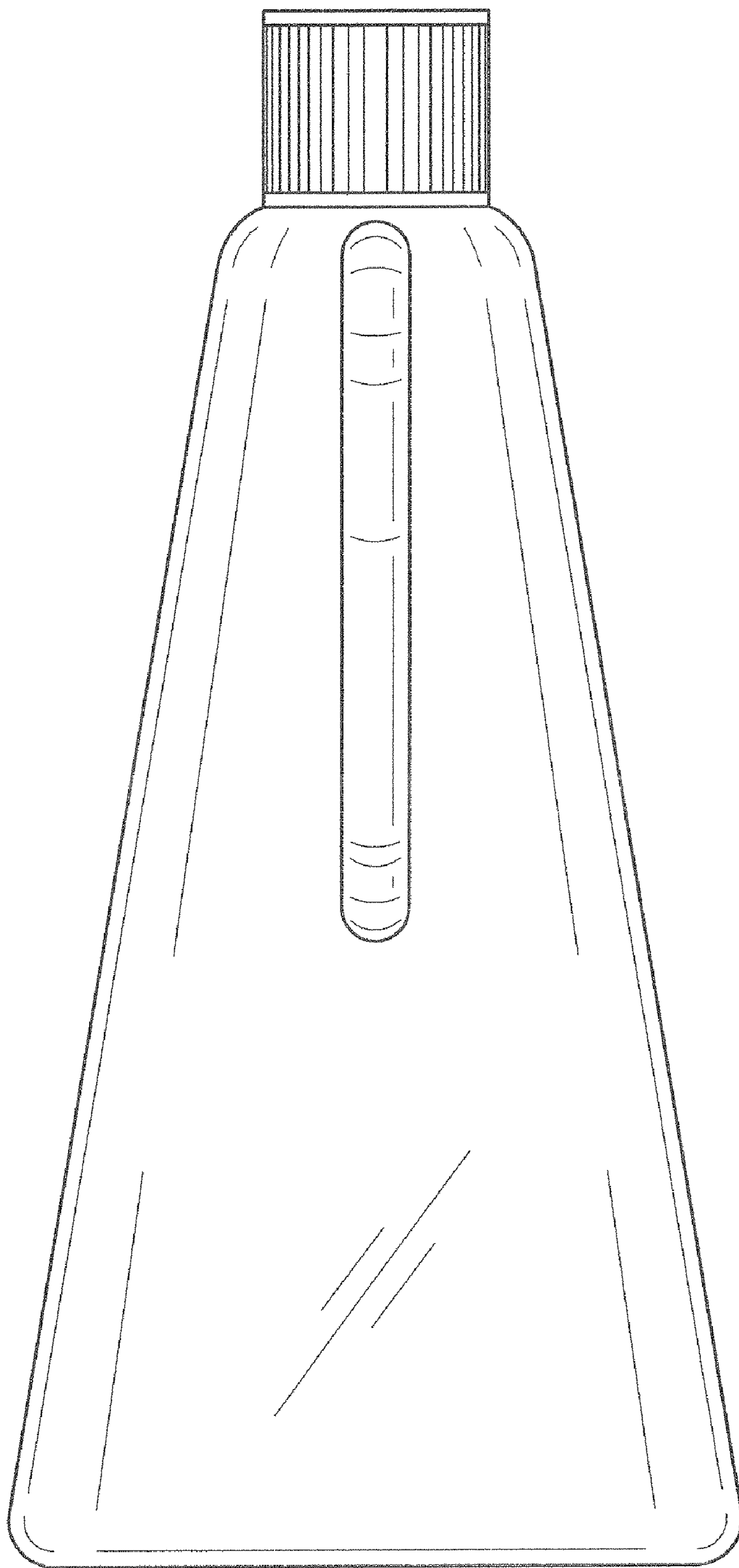

FIG. 4

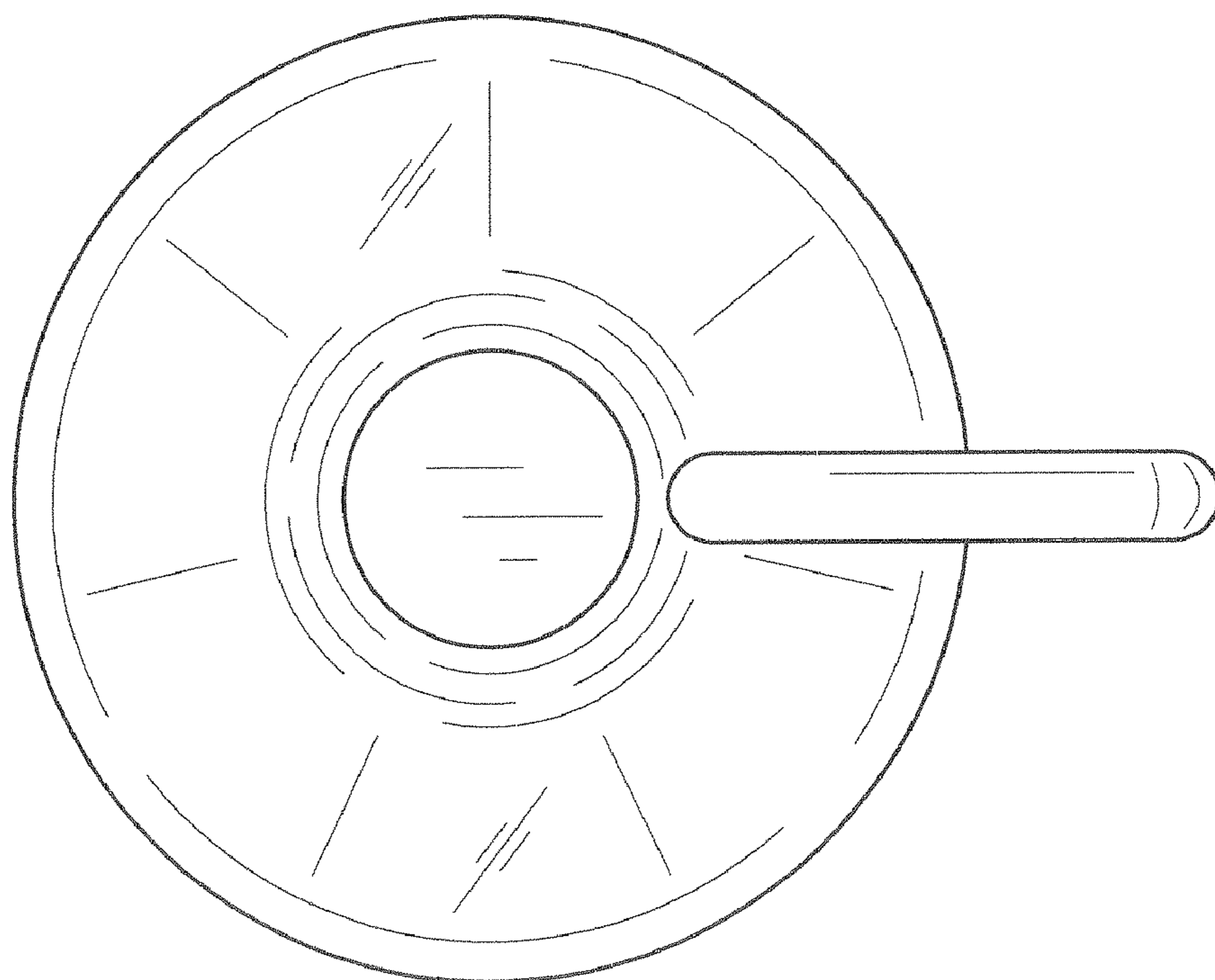

FIG. 5

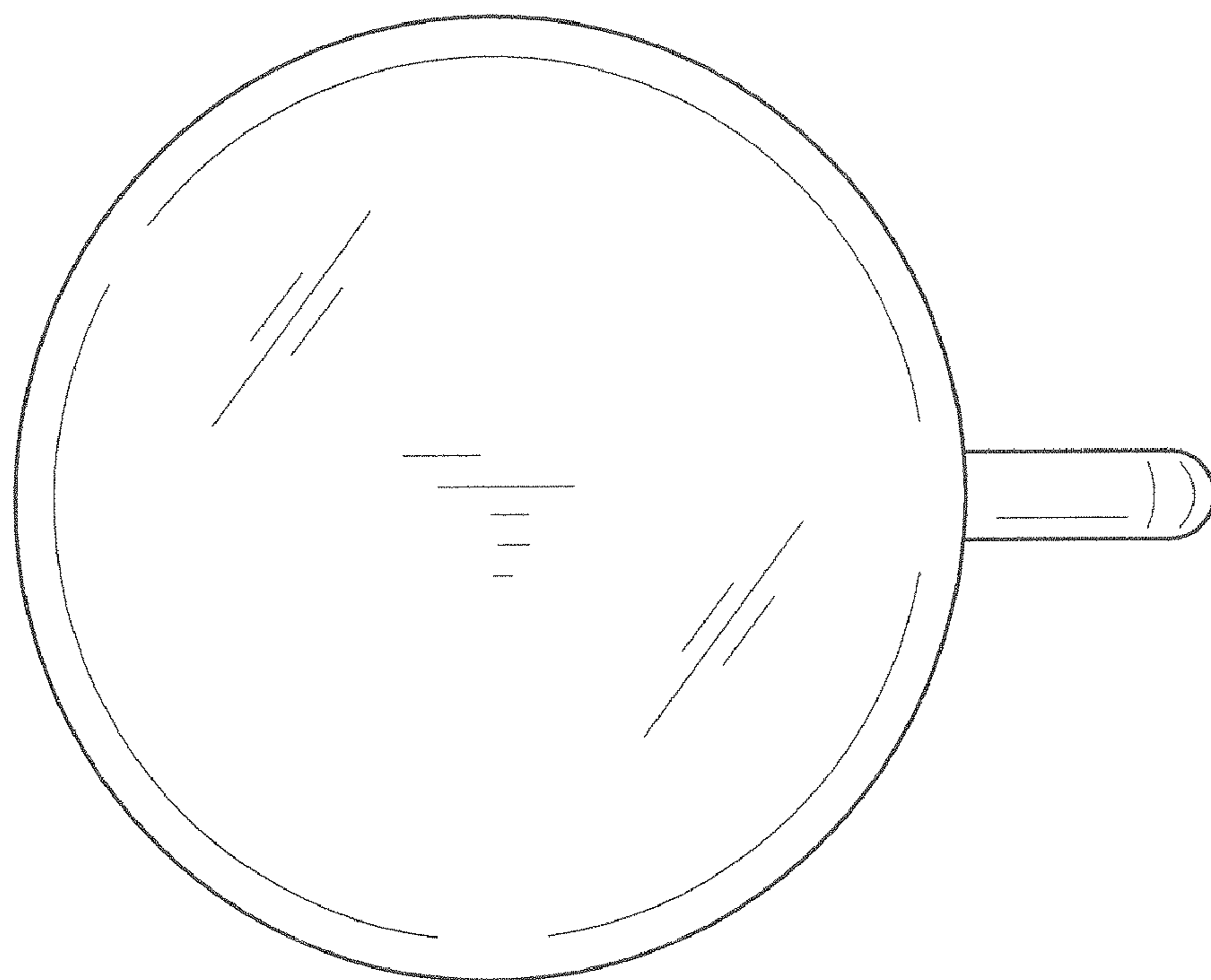

FIG. 6