



US00D631296S

(12) **United States Design Patent**  
**Green-Cotton et al.**

(10) **Patent No.:** **US D631,296 S**  
(45) **Date of Patent:** **\*\* Jan. 25, 2011**

(54) **CASSEROLE DISH**

(75) Inventors: **Deborah A. Green-Cotton**, Chicago, IL (US); **Huang BaoHua**, Shenzhen (CN); **Courtney Marsala**, Chicago, IL (US); **Shannon Colleen Fong**, San Francisco, CA (US); **Erica Eden Cohen**, New York, NY (US); **John Thomas Jacobsen**, Miller Place, NY (US); **Davin Stowell**, New York, NY (US)

(73) Assignee: **WKI Holding Company, Inc.**, Rosemont, IL (US)

(\*\*) Term: **14 Years**

(21) Appl. No.: **29/357,527**

(22) Filed: **Mar. 12, 2010**

(51) **LOC (9) Cl.** ..... **07-01**

(52) **U.S. Cl.** ..... **D7/545; D7/587**

(58) **Field of Classification Search** ..... D7/587, D7/545, 586, 543, 546, 549, 550.1, 553.6, D7/554.1, 584, 629, 354, 602, 360, 566, 500, D7/542; D9/500, 501; 294/172; D32/35, D32/53; 220/574, 659, 23.83, 671, 573.1, 220/669, 23.87; 206/507, 557, 561-565  
See application file for complete search history.

(56) **References Cited**

**U.S. PATENT DOCUMENTS**

D289,844	S	*	5/1987	Daenen et al.	.....	D7/354
5,423,451	A	*	6/1995	Snyder	.....	220/574
D418,017	S	*	12/1999	Henry	.....	D7/545
D429,961	S	*	8/2000	Harris	.....	D7/540
D432,361	S	*	10/2000	Jenkins	.....	D7/554.3
D445,633	S	*	7/2001	Bradley	.....	D7/360
D470,005	S	*	2/2003	Cooper et al.	.....	D7/360
D475,246	S	*	6/2003	Jørgensen	.....	D7/545
D477,187	S	*	7/2003	McCallister et al.	.....	D7/545
D490,643	S	*	6/2004	Groll	.....	D7/354
D514,373	S	*	2/2006	Vendl et al.	.....	D7/360
D544,755	S	*	6/2007	Diesman	.....	D7/602
D567,029	S	*	4/2008	Valderrama et al.	.....	D7/545

D573,411	S	*	7/2008	Lovett	.....	D7/554.3
D582,201	S	*	12/2008	Kellermann et al.	.....	D7/360
D606,176	S	*	12/2009	Urquiola	.....	D23/293.1
D606,177	S	*	12/2009	Urquiola	.....	D23/293.1
D607,688	S	*	1/2010	Hart et al.	.....	D7/360

(Continued)

*Primary Examiner*—Cynthia Underwood

(74) *Attorney, Agent, or Firm*—McDermott Will & Emery LLP

(57) **CLAIM**

We claim the ornamental design for a casserole dish, as shown and described.

**DESCRIPTION**

FIG. 1 is a perspective view of a casserole dish according to the new design;

FIG. 2 is a top view of a casserole dish according to the new design shown in FIG. 1

FIG. 3 bottom view of a casserole dish according to the new design shown in FIG. 1

FIG. 4 is a front elevation view of the casserole dish shown in FIG. 1;

FIG. 5 is a rear elevation view of the casserole dish shown in FIG. 1;

FIG. 6 is a left side elevation view of the casserole dish shown in FIG. 1;

FIG. 7 is a right side elevation view of the casserole dish shown in FIG. 1; and,

FIG. 8 is an enlarged view of Section 6 shown in FIG. 4.

Features shown in broken lines are for illustrative purposes only and the structure within the broken lines forms no part of the claimed design.

**1 Claim, 5 Drawing Sheets**

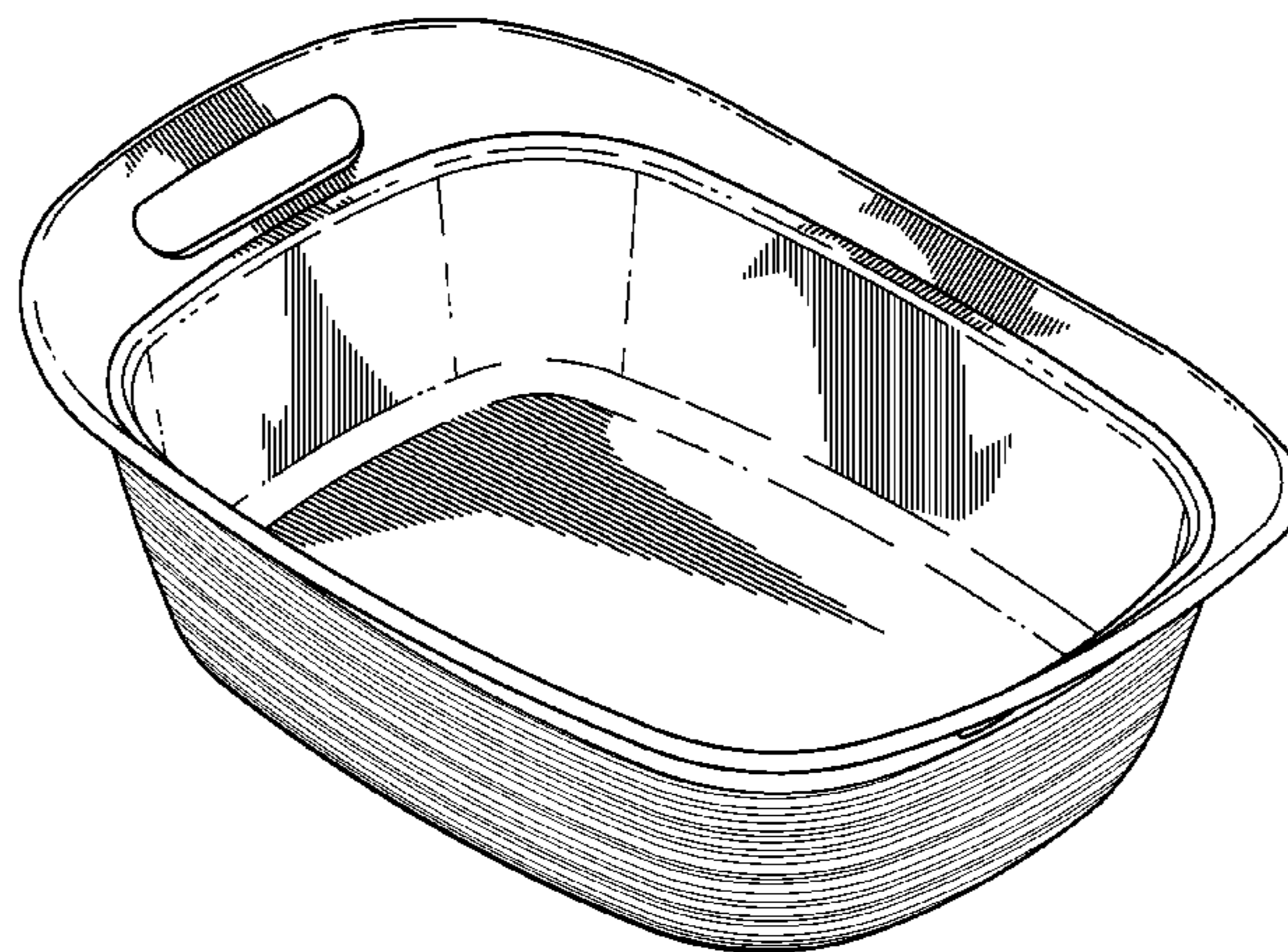

# US D631,296 S

Page 2

---

## U.S. PATENT DOCUMENTS

D607,689 S *	1/2010	Hart et al. ....	D7/360	D609,532 S *	2/2010	Koennecke .....	D7/584
D609,530 S *	2/2010	Hart et al. ....	D7/545	D611,305 S *	3/2010	Hart et al. ....	D7/545
D609,531 S *	2/2010	Koennecke .....	D7/584	D621,664 S *	8/2010	Heiberg et al. ....	D7/587
				7,784,638 B2 *	8/2010	Kishbaugh et al. ....	220/573.3

\* cited by examiner

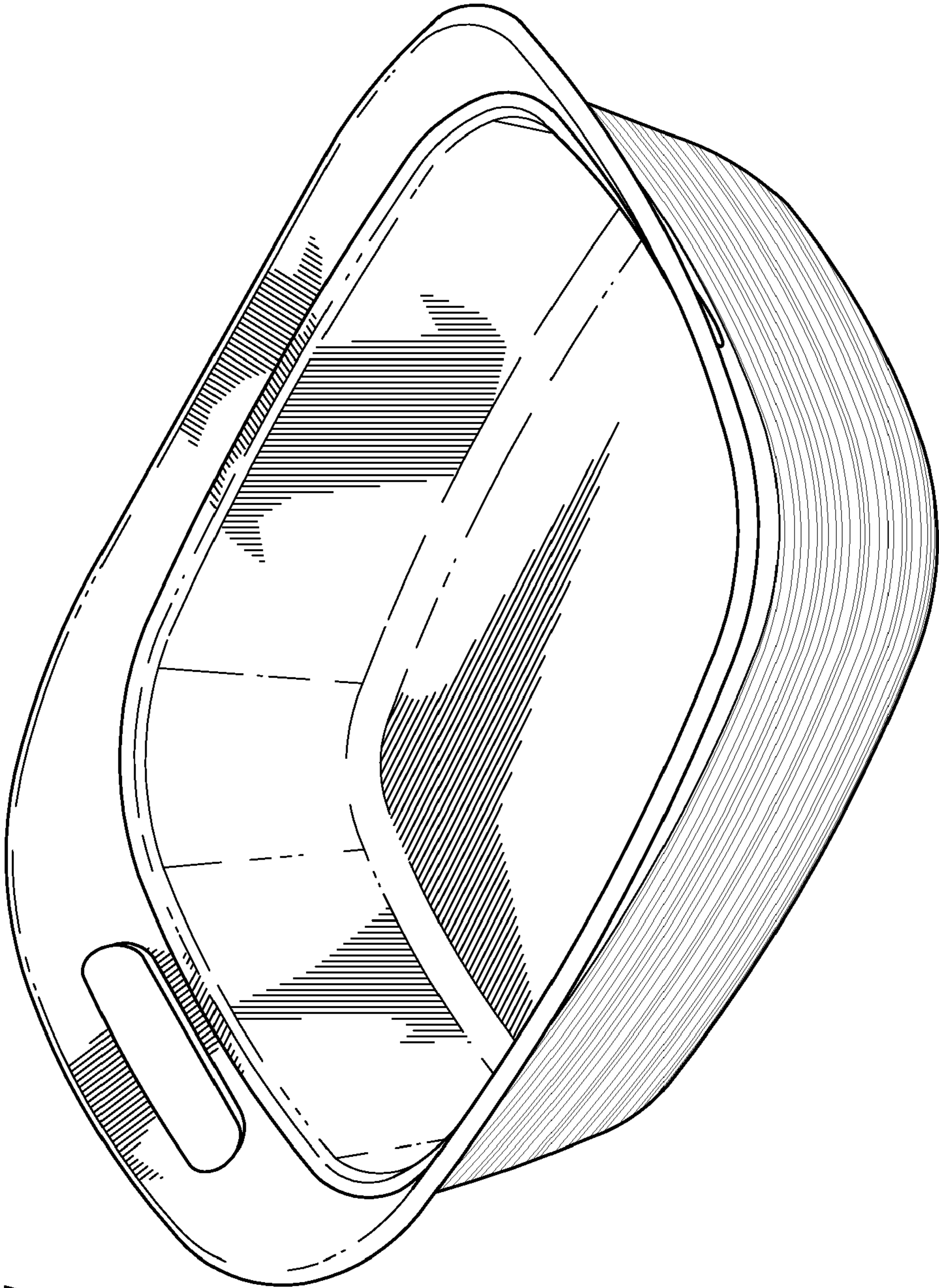

FIG. 1

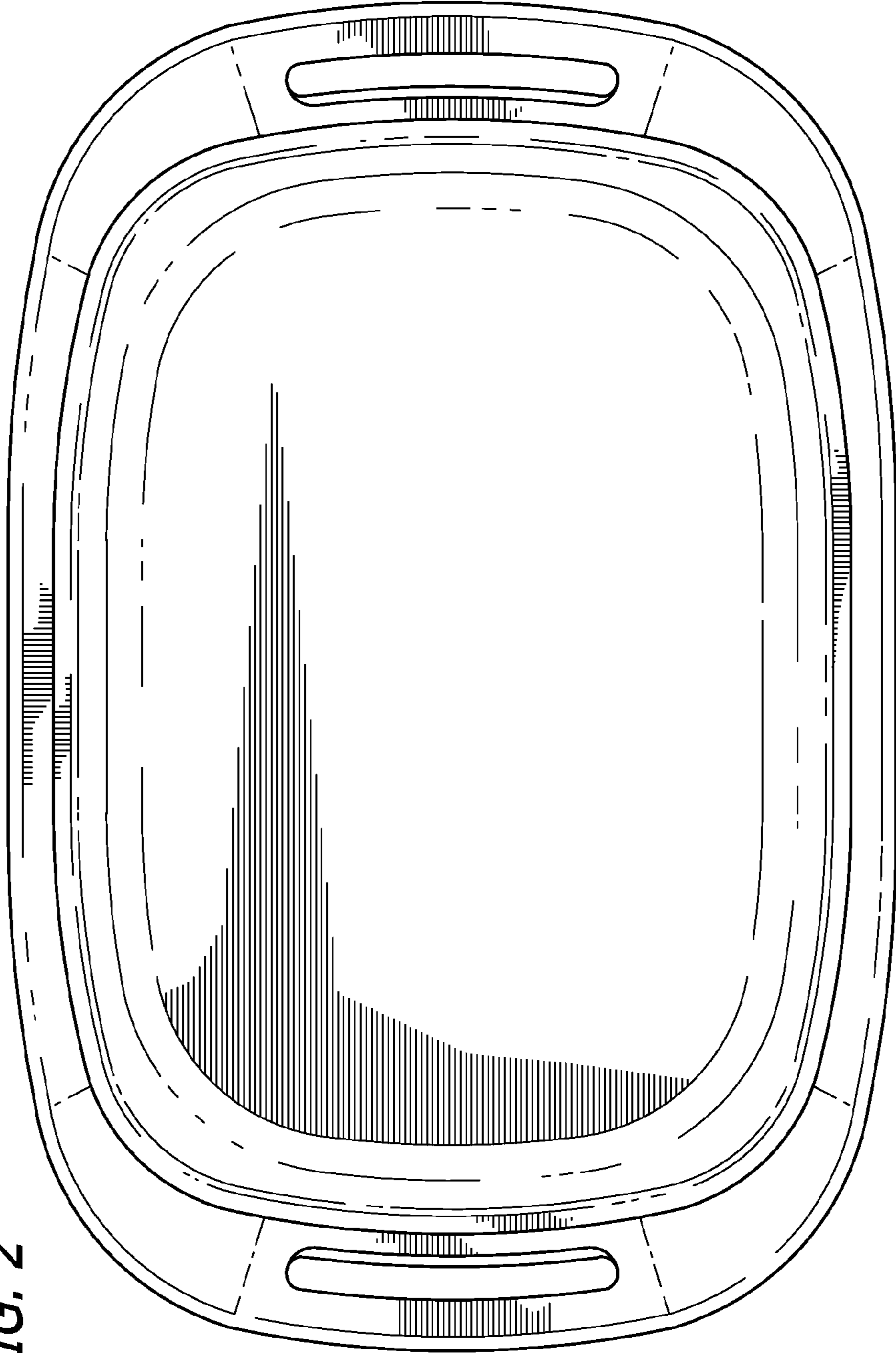

FIG. 2

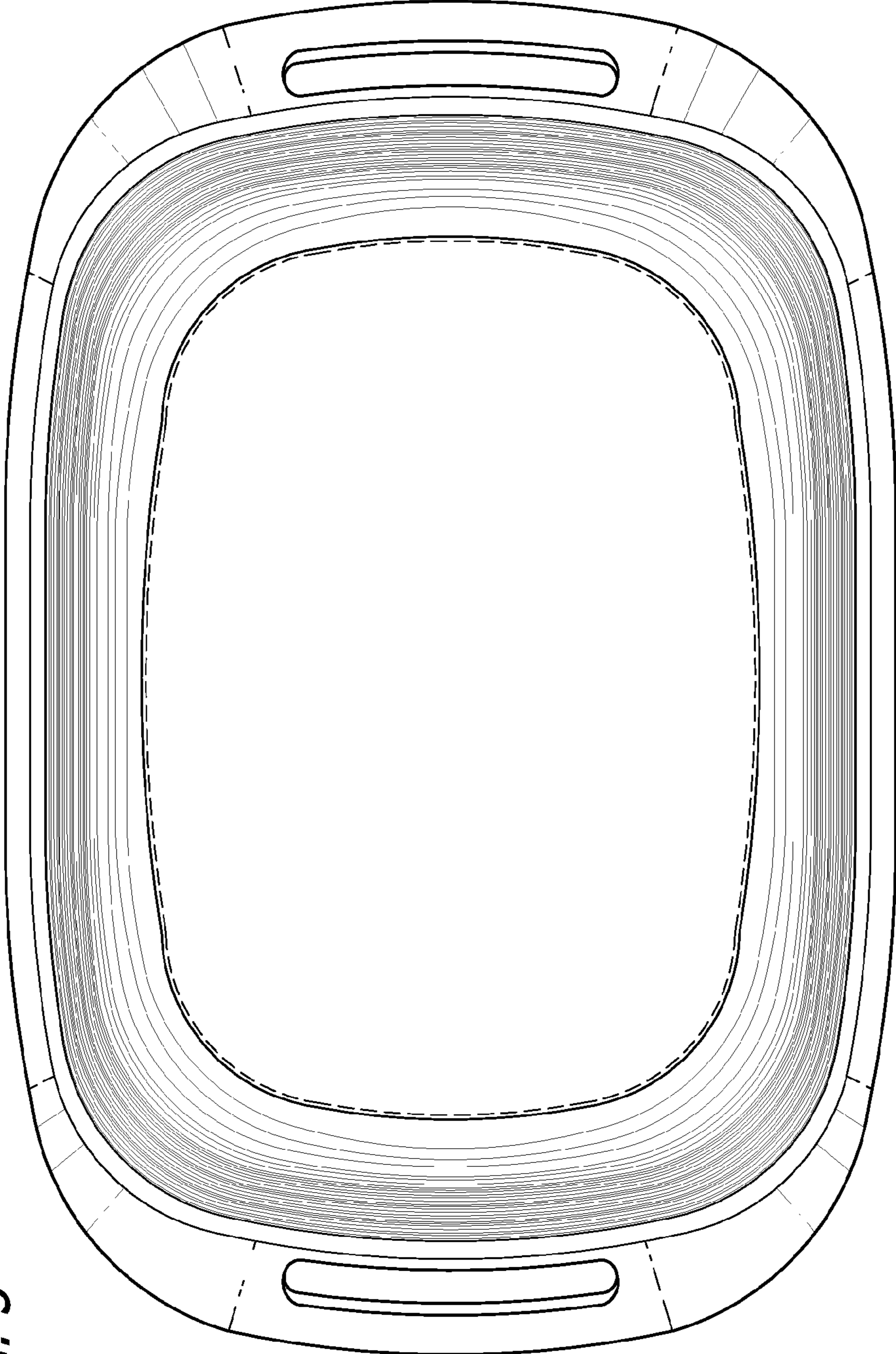

FIG. 3

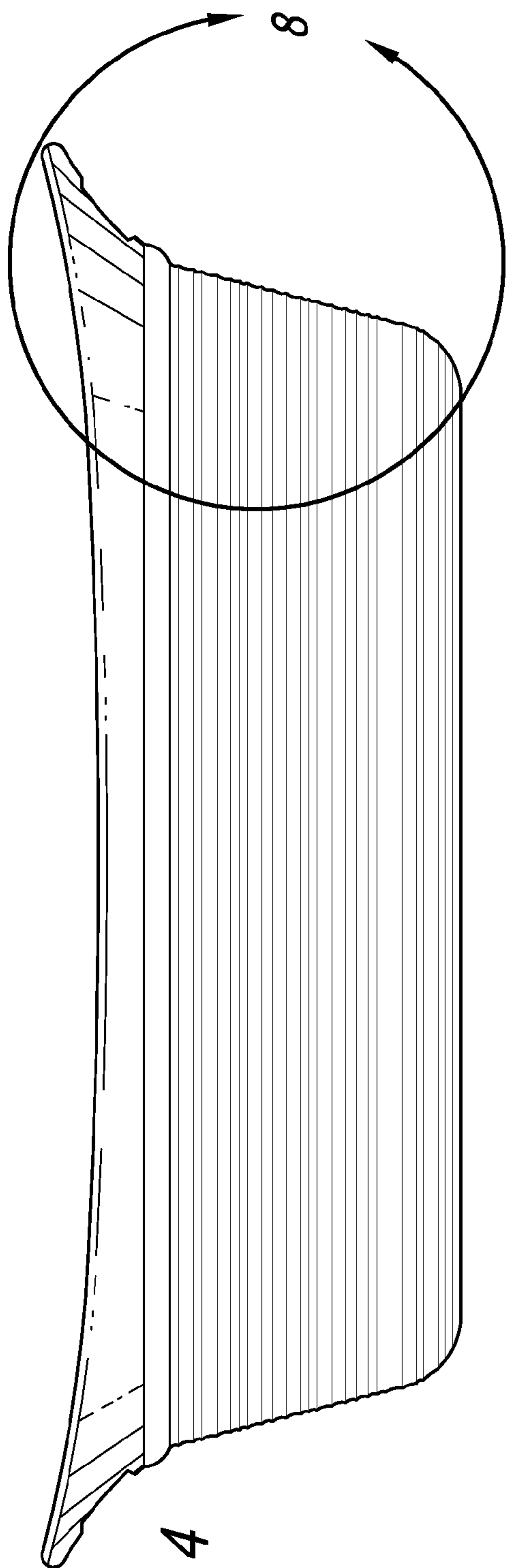

FIG. 4

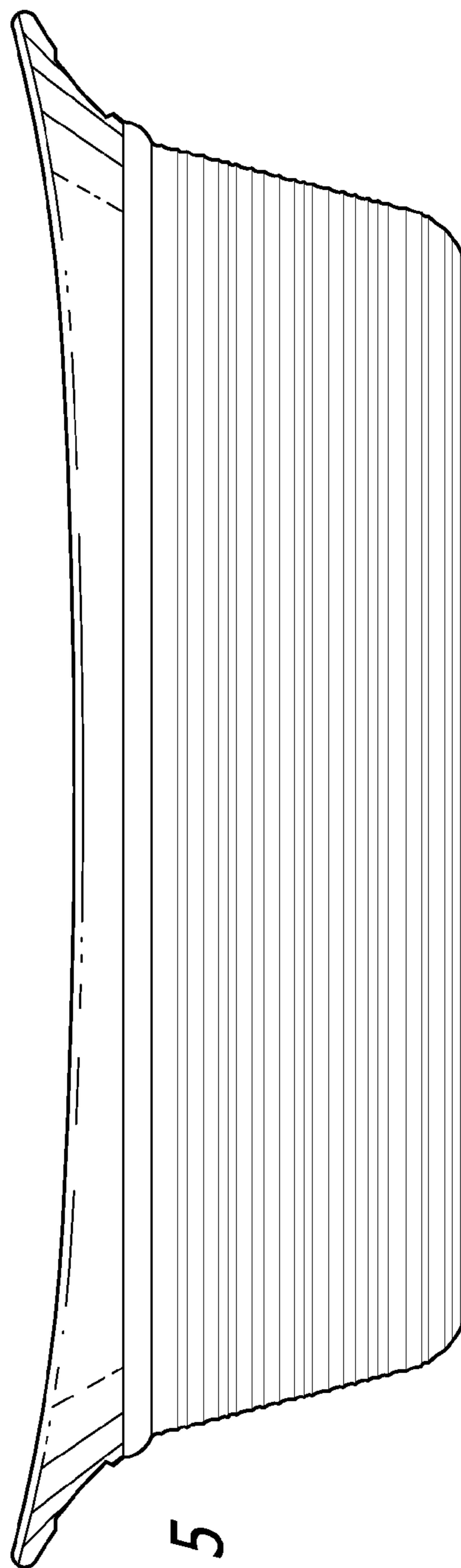

FIG. 5

FIG. 6

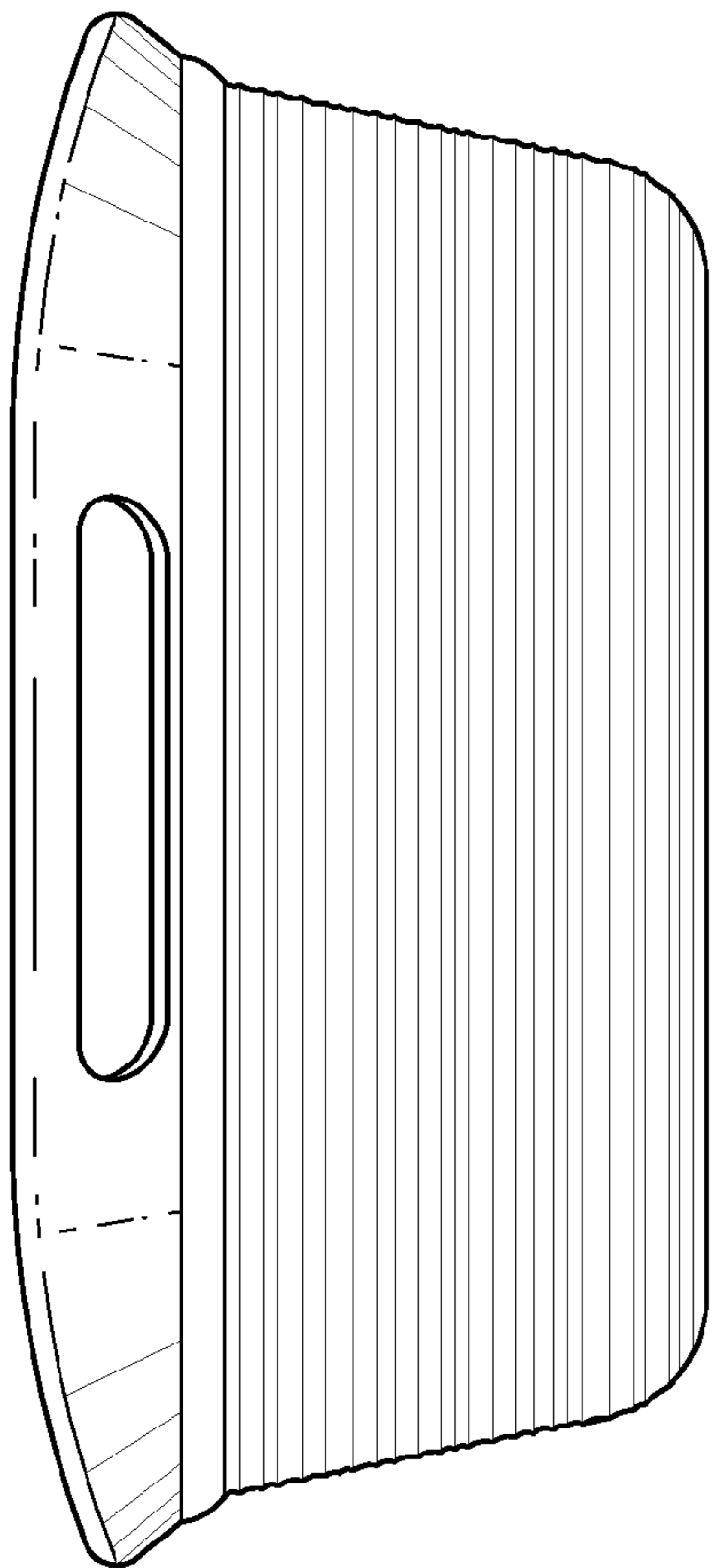

FIG. 7

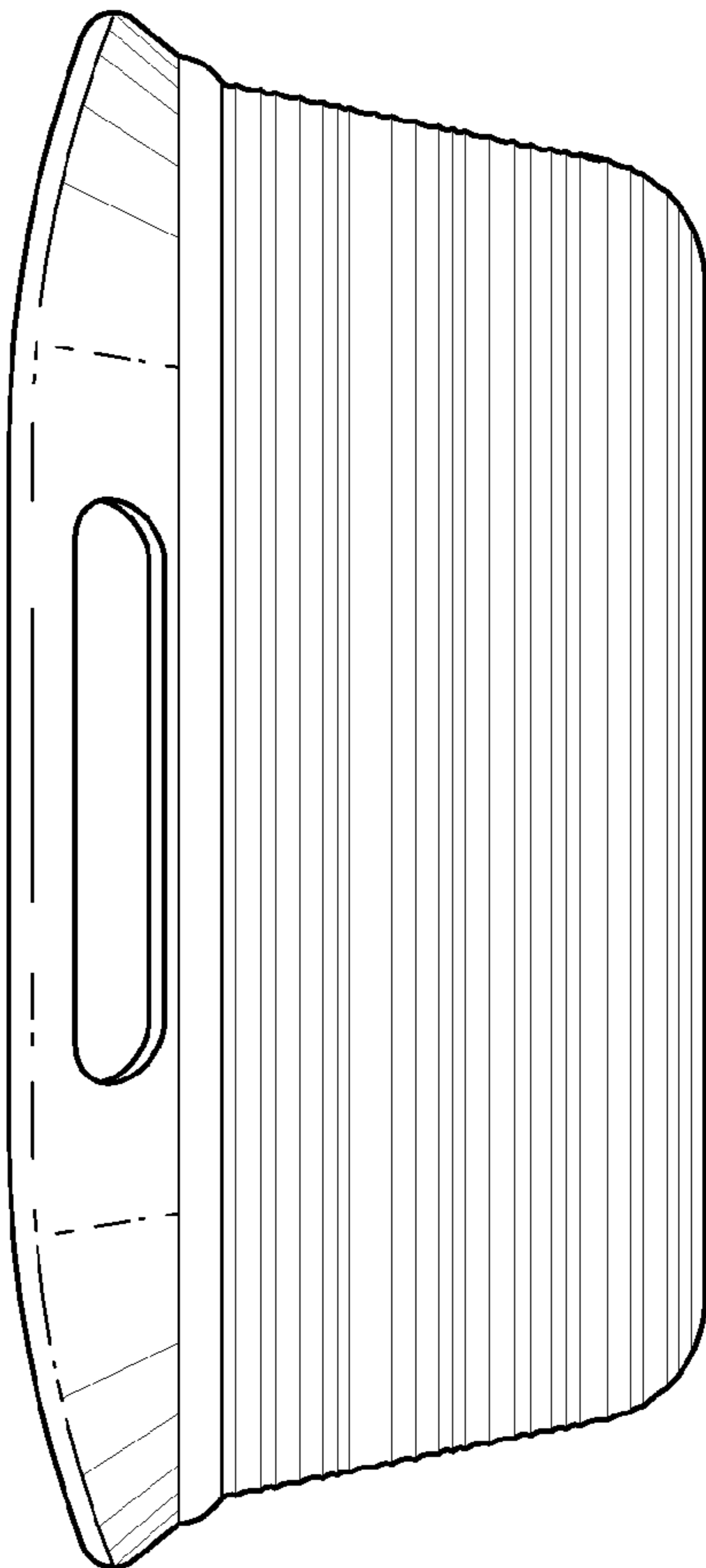
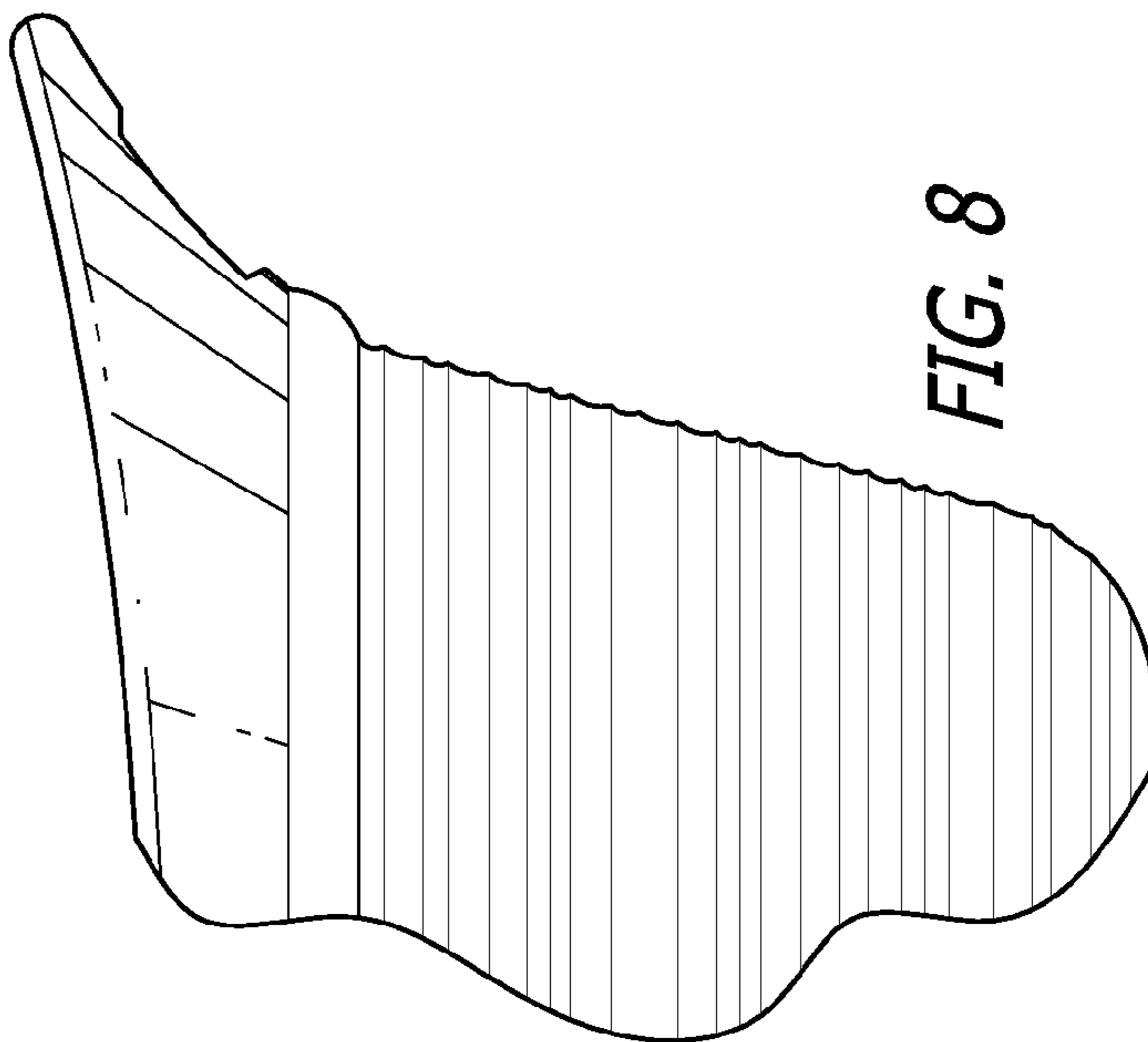

FIG. 8



UNITED STATES PATENT AND TRADEMARK OFFICE  
**CERTIFICATE OF CORRECTION**

PATENT NO. : D631,296 S  
APPLICATION NO. : 29/357527  
DATED : January 25, 2011  
INVENTOR(S) : Green-Cotton et al.

Page 1 of 1

It is certified that error appears in the above-identified patent and that said Letters Patent is hereby corrected as shown below:

In the Description, the words --is a-- should be added after "FIG. 3"

Signed and Sealed this  
Fifth Day of April, 2011

A handwritten signature in black ink that reads "David J. Kappos". The signature is written in a cursive style with a large initial 'D' and 'K'.

David J. Kappos  
*Director of the United States Patent and Trademark Office*