



US00D631287S

(12) **United States Design Patent**
Grasso et al.

(10) **Patent No.:** **US D631,287 S**
(45) **Date of Patent:** **** Jan. 25, 2011**

(54) **GRILL HANDLE**

(75) Inventors: **James Grasso**, Arlington Heights, IL (US); **Ewald Sieg**, Palatine, IL (US); **Charles Choi**, Chicago, IL (US); **Adrian A. Bruno**, Rolling Meadows, IL (US)

(73) Assignee: **Weber-Stephen Products Co.**, Palatine, IL (US)

(**) Term: **14 Years**

(21) Appl. No.: **29/345,047**

(22) Filed: **Oct. 8, 2009**

(51) **LOC (9) Cl.** **07-02**

(52) **U.S. Cl.** **D7/394; D7/402**

(58) **Field of Classification Search** D7/394,
D7/332, 334-337, 402-404; 16/436, 431,
16/114.1, 419, 415; 126/25 R, 9 R, 40, 50,
126/41 R, 38; 431/344; 99/425; D8/315-317,
D8/319, 320

See application file for complete search history.

(56) **References Cited**

U.S. PATENT DOCUMENTS

D183,489	S *	9/1958	Hvale	D7/394
3,959,620	A *	5/1976	Stephen, Jr.	219/386
4,498,452	A *	2/1985	Schlosser et al.	126/9 R
4,836,179	A *	6/1989	Schlosser et al.	126/25 R
5,076,252	A	12/1991	Schlosser et al.		
5,111,802	A	5/1992	Lin		
D379,581	S *	6/1997	Sieg et al.	D8/316
5,771,536	A *	6/1998	Sieg et al.	16/431
D405,643	S *	2/1999	Coleman et al.	D7/402
D415,653	S	10/1999	Schlosser et al.		
6,155,248	A	12/2000	Schlosser et al.		
D435,761	S *	1/2001	Johnson	D7/402
6,220,240	B1 *	4/2001	Grady et al.	126/519
D461,096	S *	8/2002	Hung	D7/402

D468,584	S *	1/2003	Hung	D7/402
D478,472	S *	8/2003	Cozzolino et al.	D7/402
D482,950	S *	12/2003	McKenzie	D8/320
6,658,698	B2 *	12/2003	Chen	16/114.1
D520,813	S *	5/2006	Chung	D7/402
D565,890	S *	4/2008	Bunting et al.	D7/394
D576,446	S *	9/2008	Rae	D7/394
D584,921	S *	1/2009	Moulin Robson	D7/394
D592,450	S *	5/2009	Rae	D7/394
D623,003	S *	9/2010	Chung	D7/334
2003/0150082	A1 *	8/2003	Chen	16/114.1

OTHER PUBLICATIONS

The British Standard—BS EN 1860-1:2003 entitled “Appliances, Solid Fuels and Firelighters for Barbecueing; Part 1: Barbecues burning solid fuels, Requirements and Test Methods”.

* cited by examiner

Primary Examiner—Ruth McInroy

(74) *Attorney, Agent, or Firm*—David I. Roche; Daniel A. Tallitsch; Baker & McKenzie LLP

(57) **CLAIM**

The ornamental design for a grill handle, as shown and described.

DESCRIPTION

FIG. 1 is a perspective view of a grill handle showing our new design;

FIG. 2 is a front view of the handle, the rear view being a mirror image;

FIG. 3 is a perspective view thereof;

FIG. 4 is top side view thereof;

FIG. 5 is a right side view thereof, the left side being a mirror image; and,

FIG. 6 is a bottom view thereof.

The details shown in broken lines form no part of the claimed design.

1 Claim, 3 Drawing Sheets

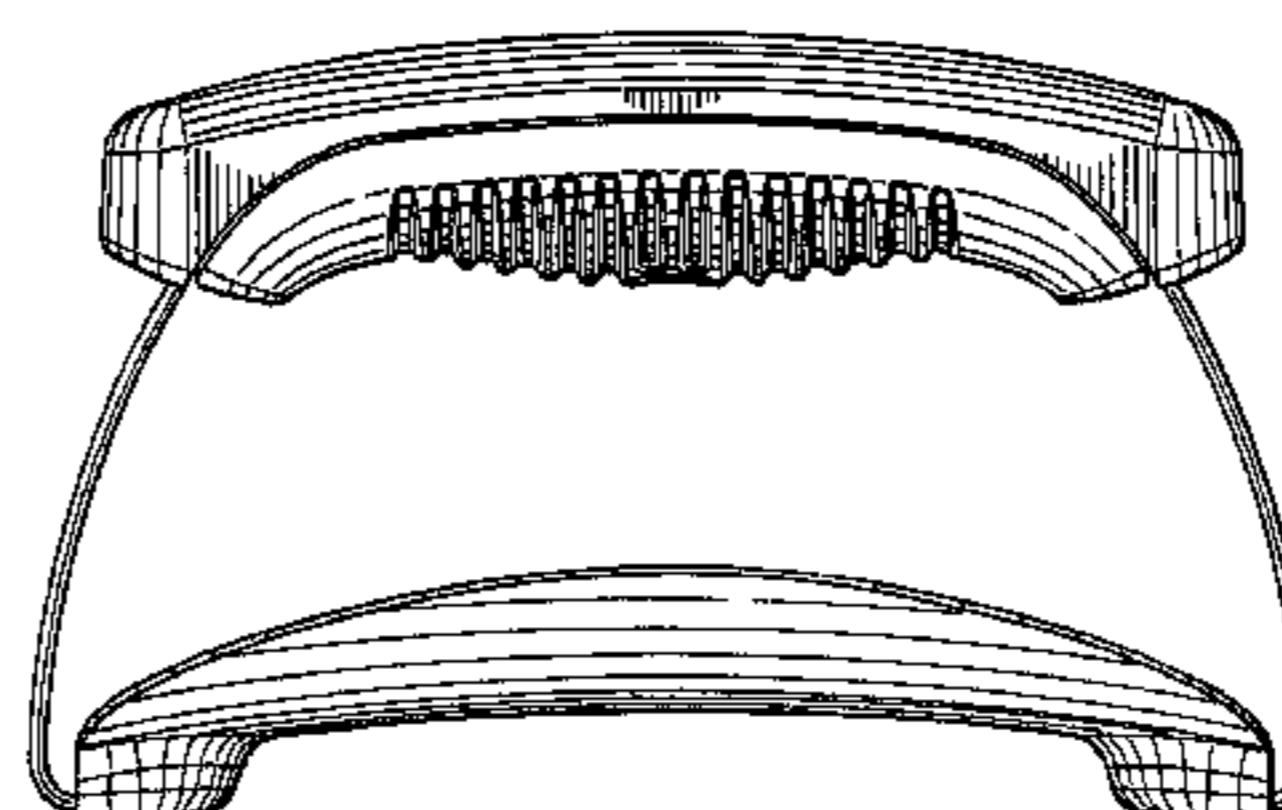
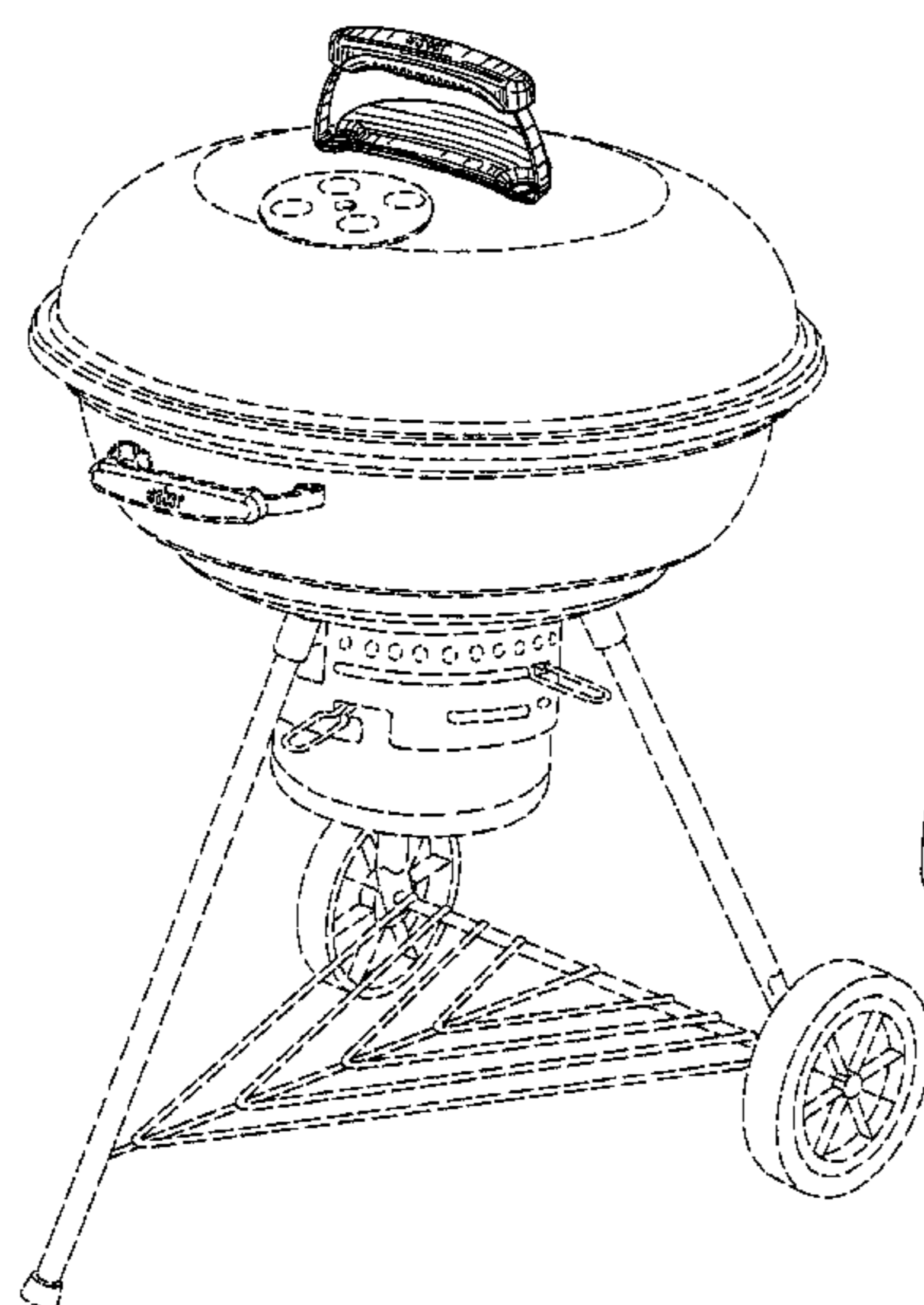
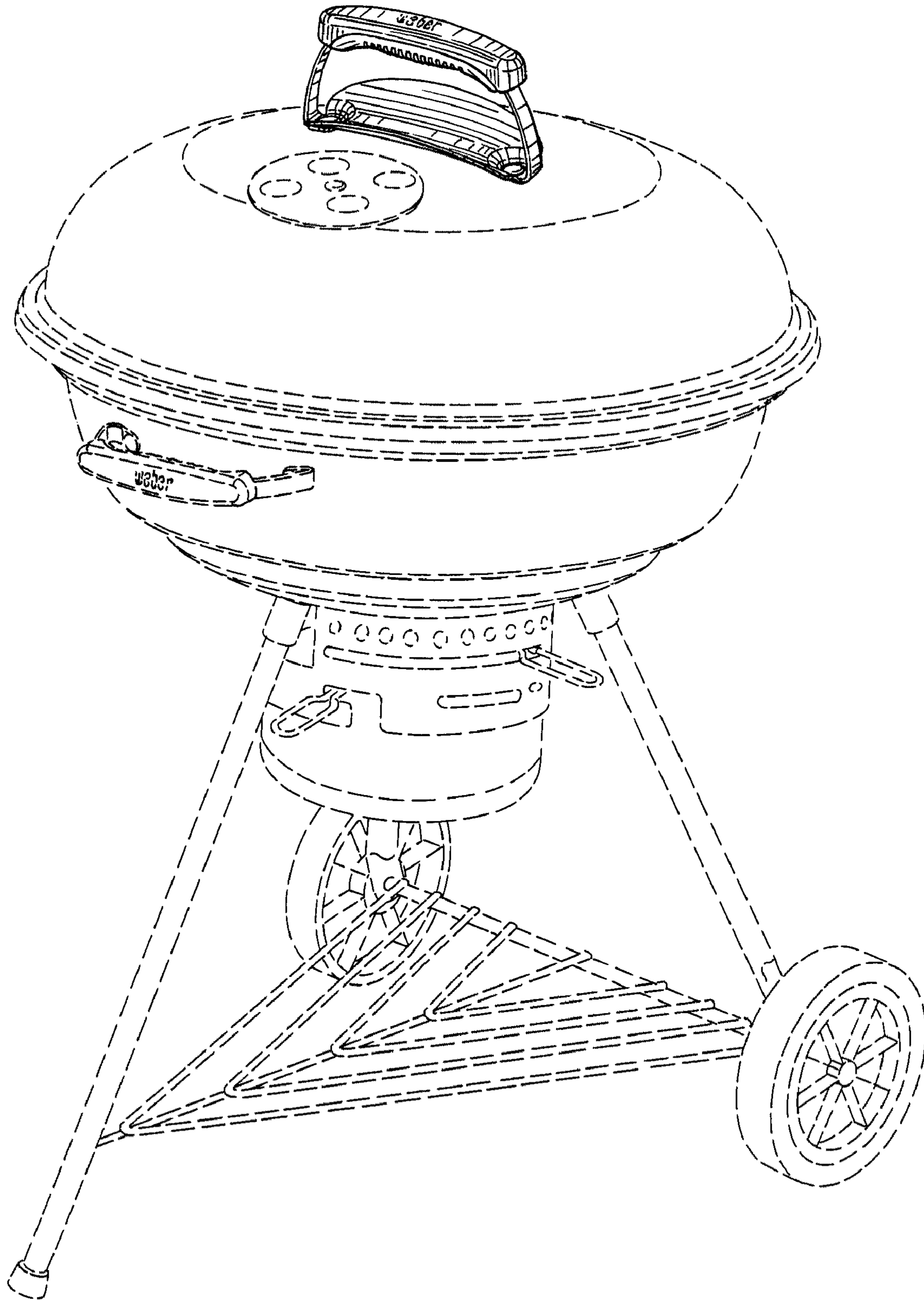

FIG. 1



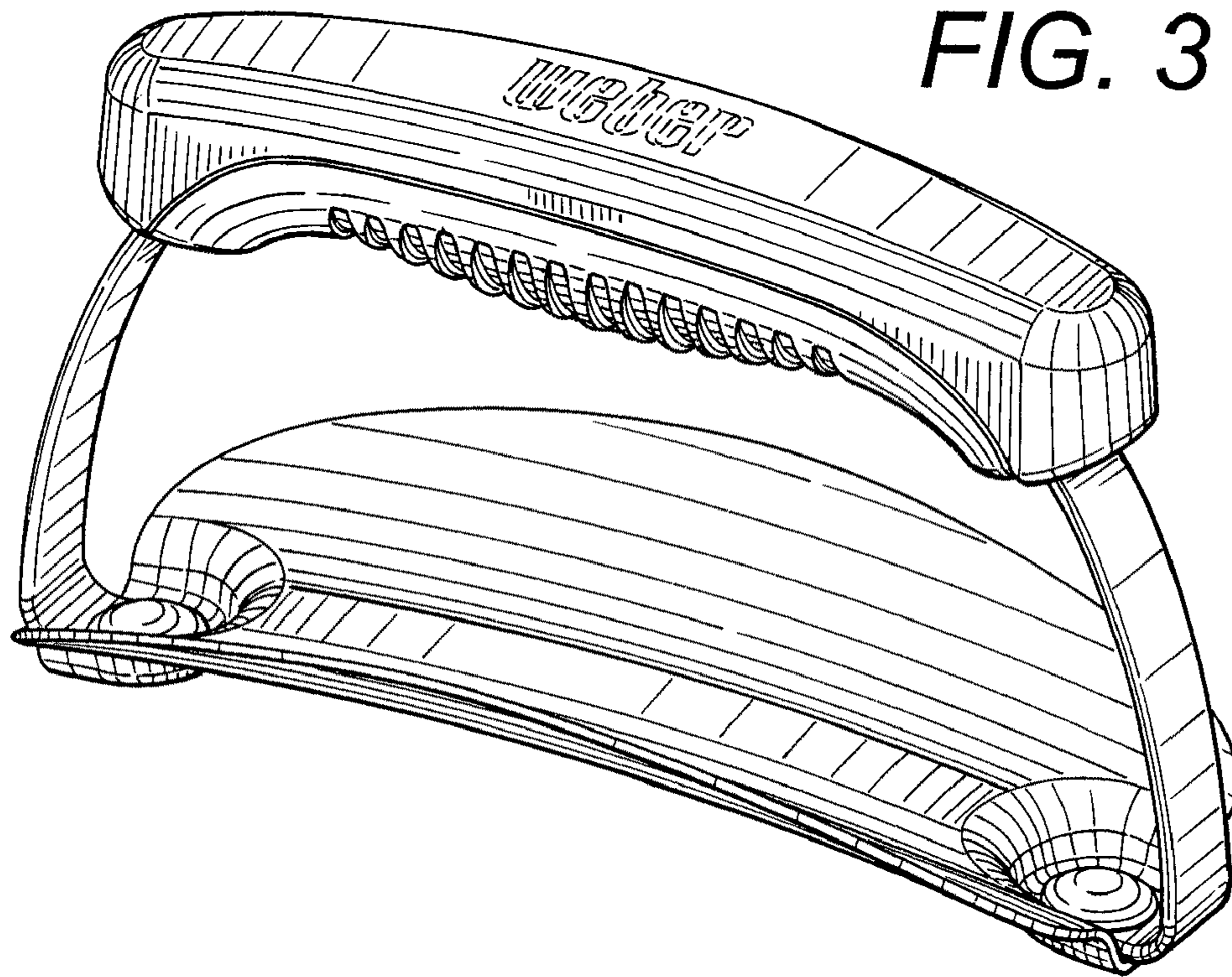

FIG. 2

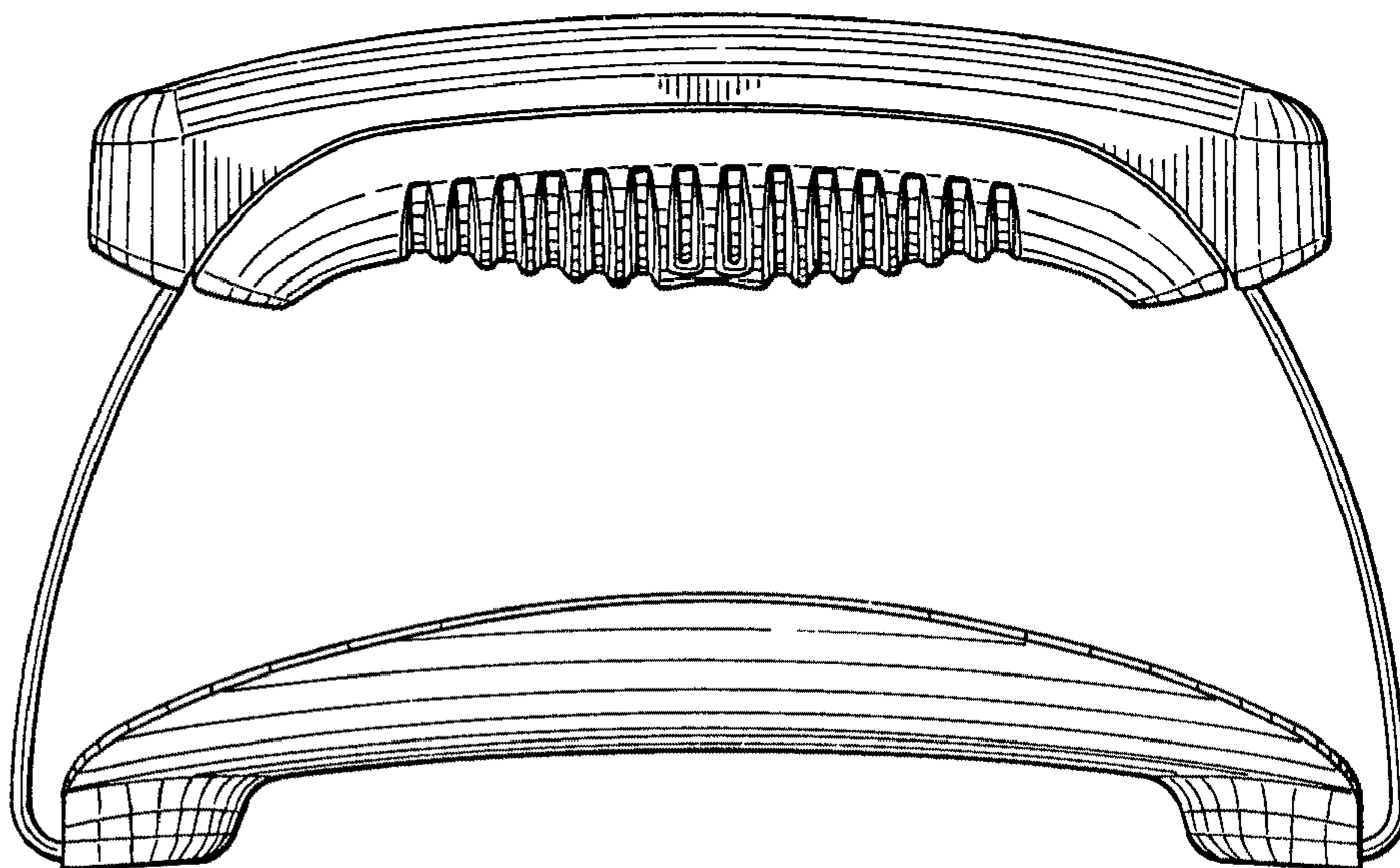

FIG. 4

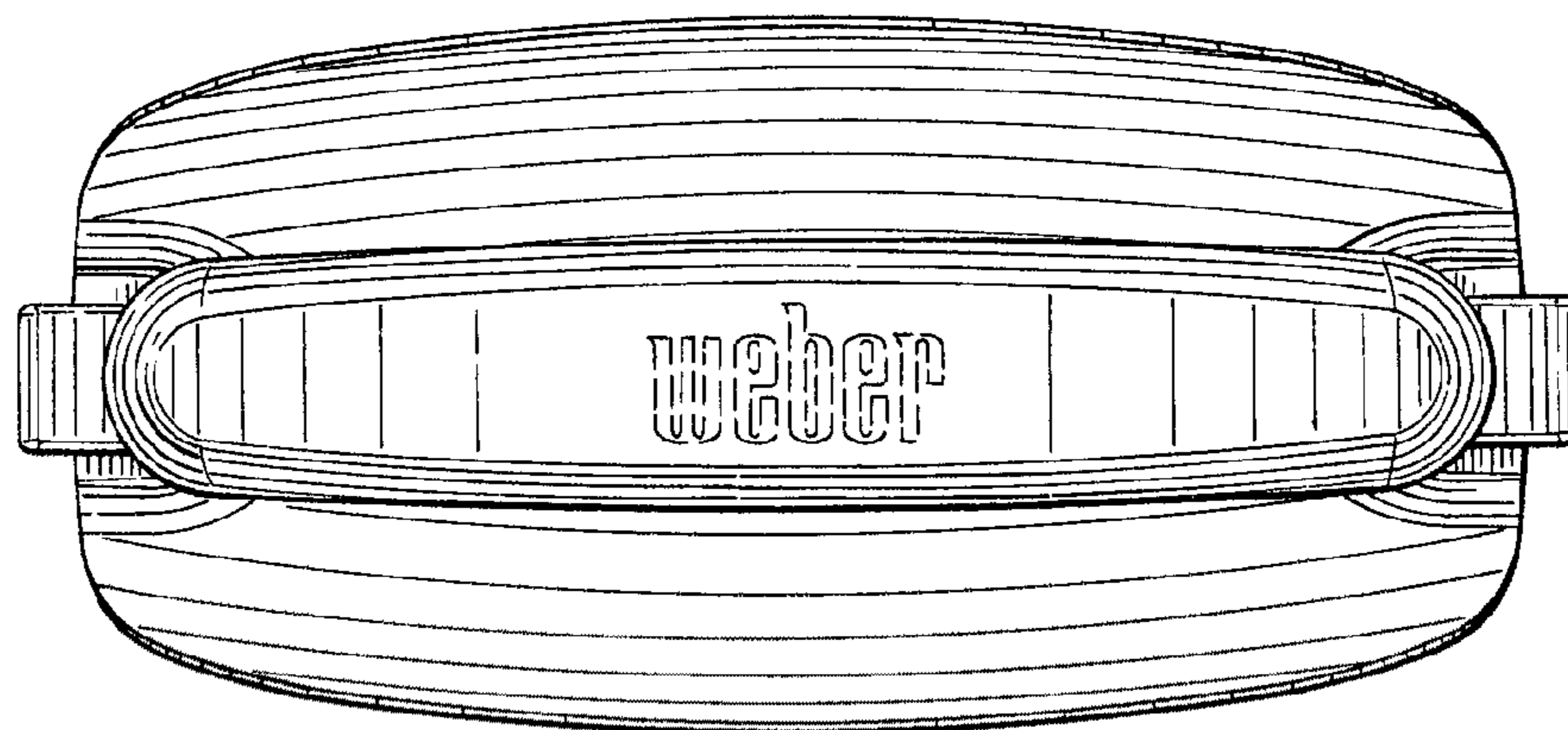

FIG. 5

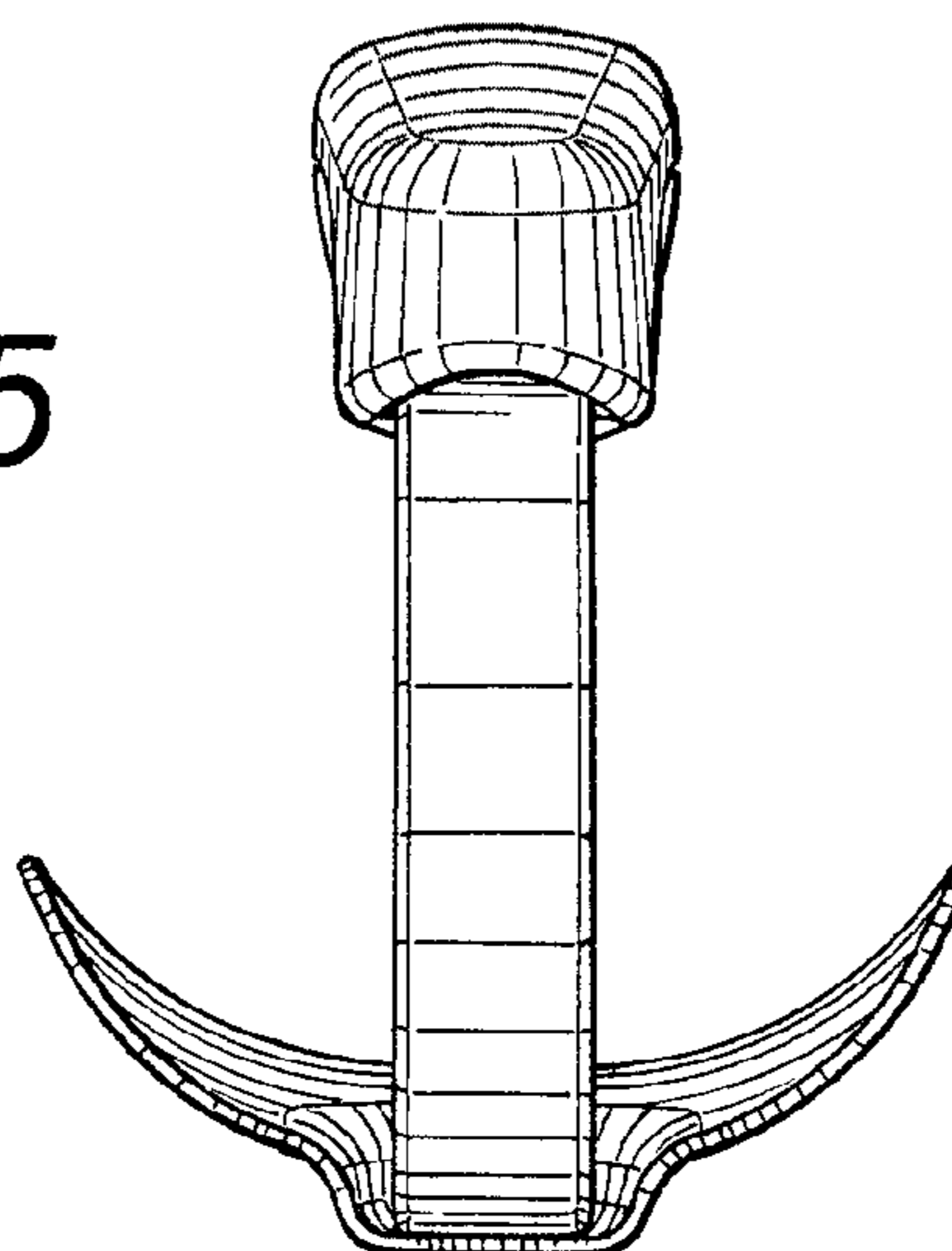

FIG. 6

