



US00D631193S

(12) **United States Design Patent**
Limongi et al.

(10) **Patent No.:** **US D631,193 S**
(45) **Date of Patent:** **** Jan. 18, 2011**

(54) **APPLICATOR FOR COSMETICS**

(75) Inventors: **Michel Limongi**, Clichy (FR); **Boris Brouillet**, Gentilly (FR)

(73) Assignee: **Alcan Packaging Beauty Services**, Gennevilliers (FR)

(**) Term: **14 Years**

(21) Appl. No.: **29/363,523**

(22) Filed: **Jun. 10, 2010**

(30) **Foreign Application Priority Data**

Dec. 11, 2009 (EM) 001646506

(51) **LOC (9) Cl.** **28-02**

(52) **U.S. Cl.** **D28/7**

(58) **Field of Classification Search** D28/7,
D28/8, 20–22, 30–31, 76, 85, 99; 132/108,
132/202, 208, 317, 320; 401/202–207, 261–267;
D4/132–135; D24/119, 211; 601/17, 129,
601/131, 154

See application file for complete search history.

(56) **References Cited**

U.S. PATENT DOCUMENTS

2,103,261 A * 12/1937 Hughes 601/154
3,236,417 A * 2/1966 Linton 222/92
5,131,384 A * 7/1992 Obagi 601/131

D341,445 S * 11/1993 Morrison et al. D28/7
D406,676 S * 3/1999 Henry D28/7
D426,916 S * 6/2000 Ebert D28/7
6,129,469 A * 10/2000 Messer et al. 401/6
6,925,672 B1 * 8/2005 Bromley 15/104.94
D518,915 S * 4/2006 Angeletta D28/7
7,476,048 B2 * 1/2009 Prague 401/262

* cited by examiner

Primary Examiner—Janice E Seeger

Assistant Examiner—Zenia I Bennett

(74) *Attorney, Agent, or Firm*—Banner & Witcoff, Ltd.

(57) **CLAIM**

The ornamental design for an applicator for cosmetics, as shown and described.

DESCRIPTION

FIG. 1 is a top, rear, right perspective view of an applicator for cosmetics showing our new design;

FIG. 2 is a top, rear, right perspective view thereof;

FIG. 3 is a top, front, right perspective view thereof;

FIG. 4 is a right view thereof;

FIG. 5 is a front view thereof; and,

FIG. 6 is a top view thereof.

The broken lines in the drawing are for illustrative purposes only and form no part of the claimed design.

1 Claim, 5 Drawing Sheets

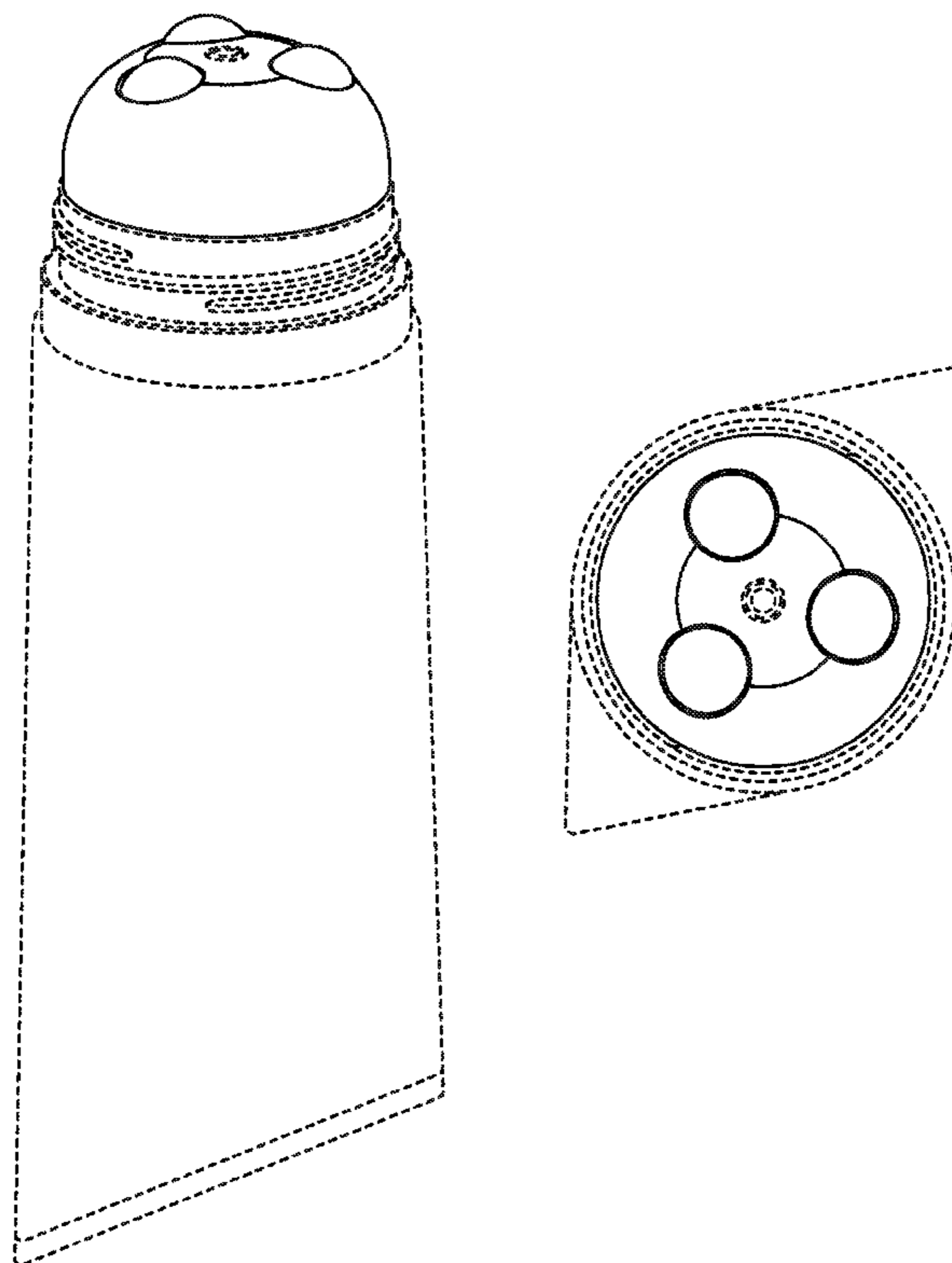

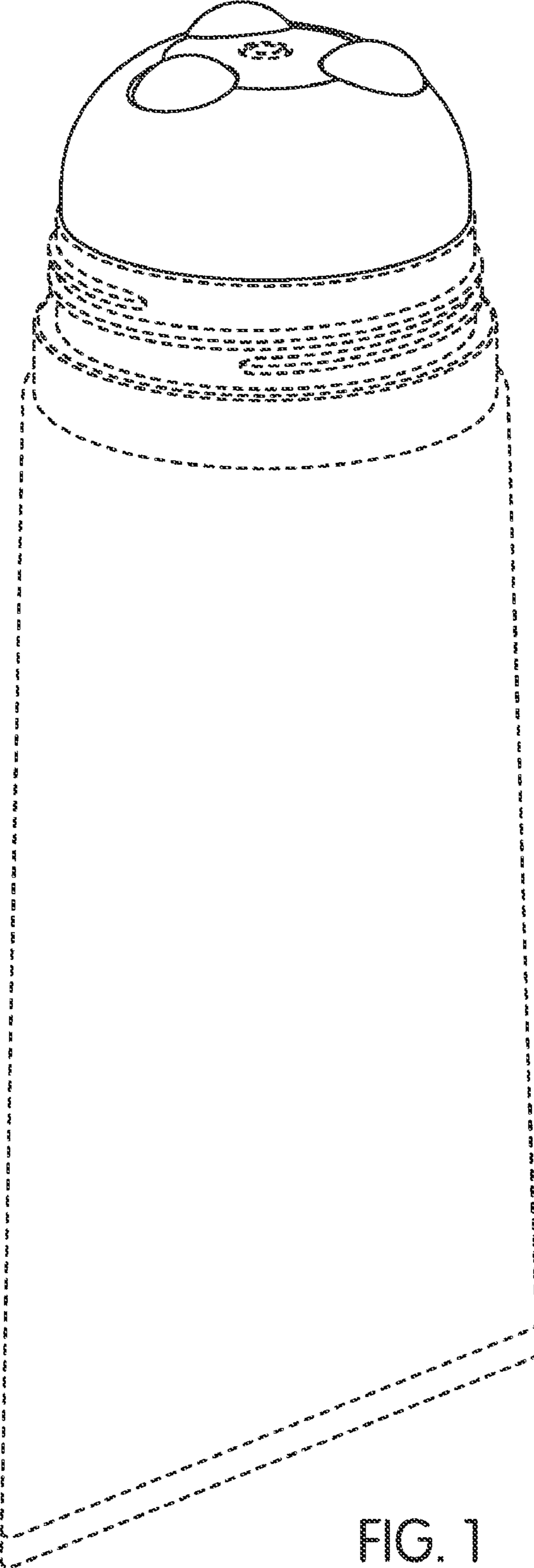

FIG. 1

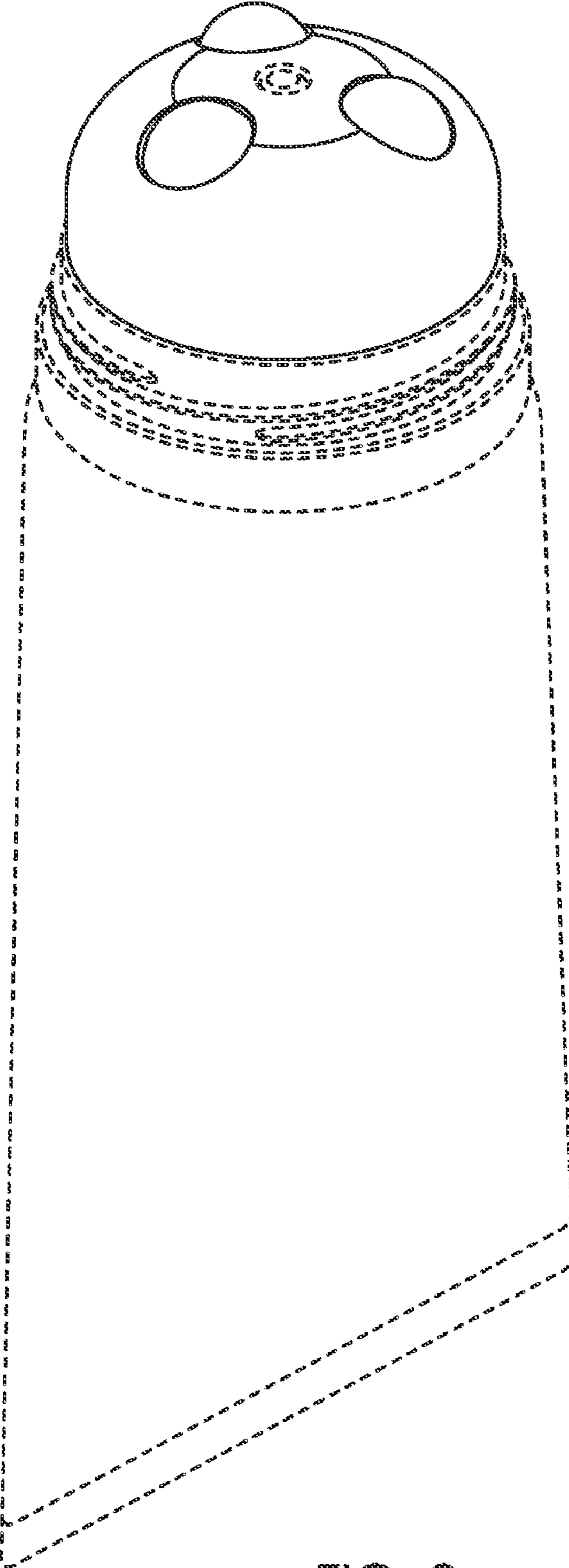

FIG. 2

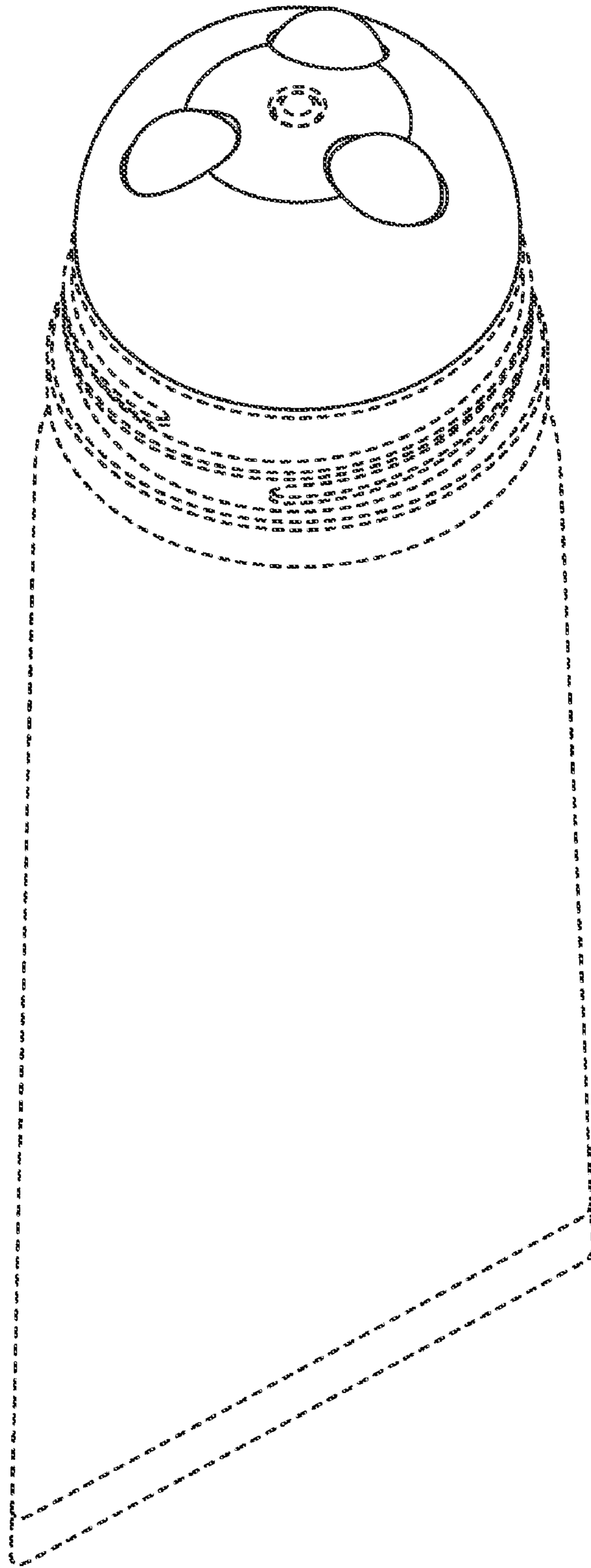

FIG. 3

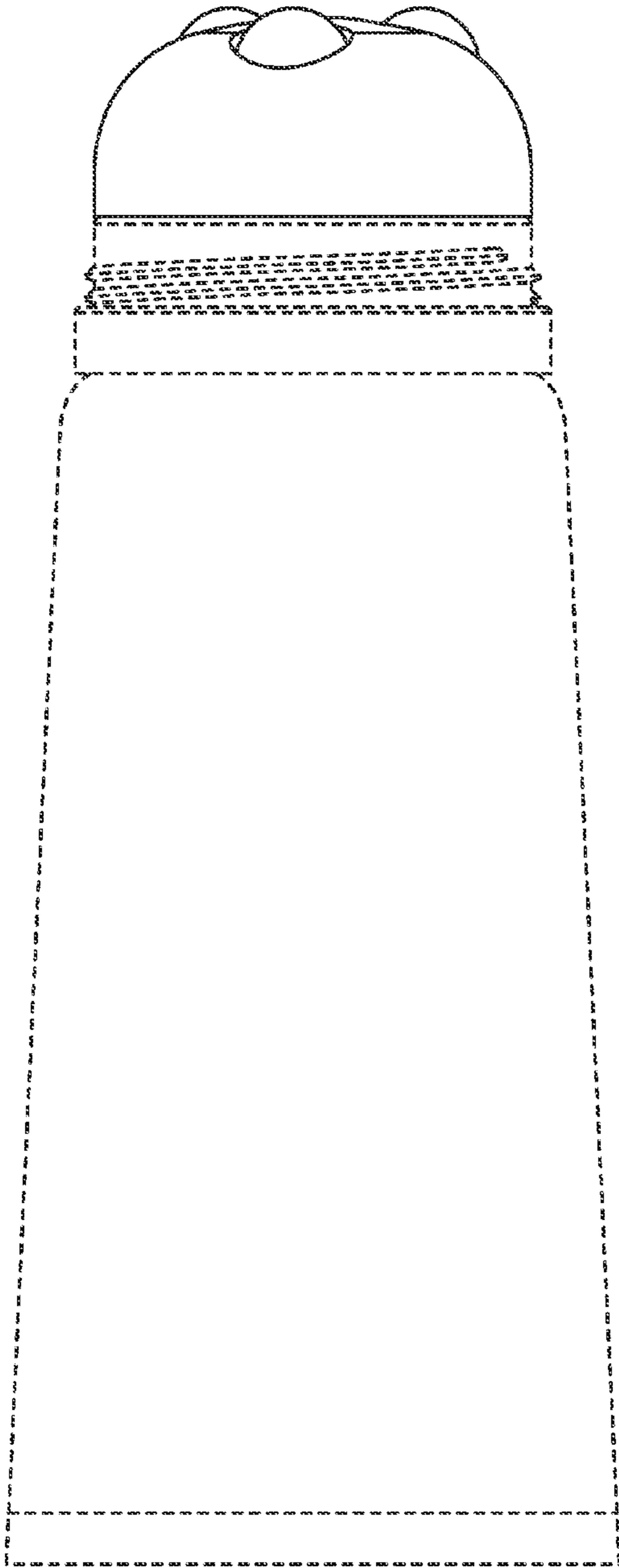

FIG. 4

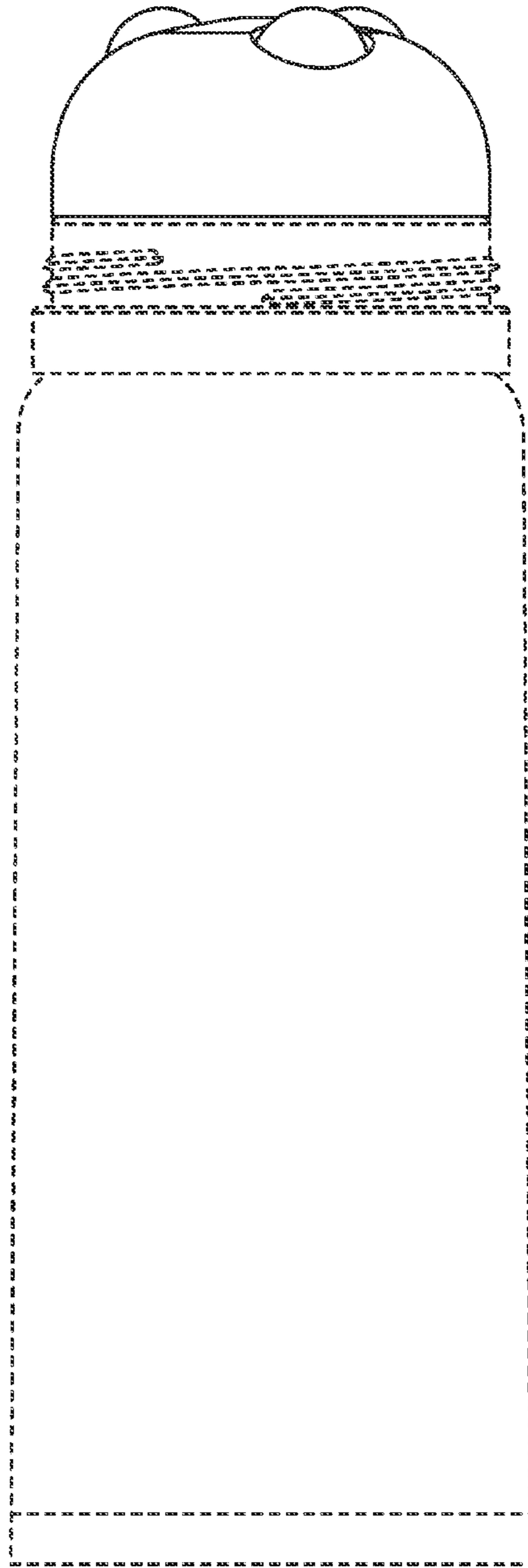

FIG. 5

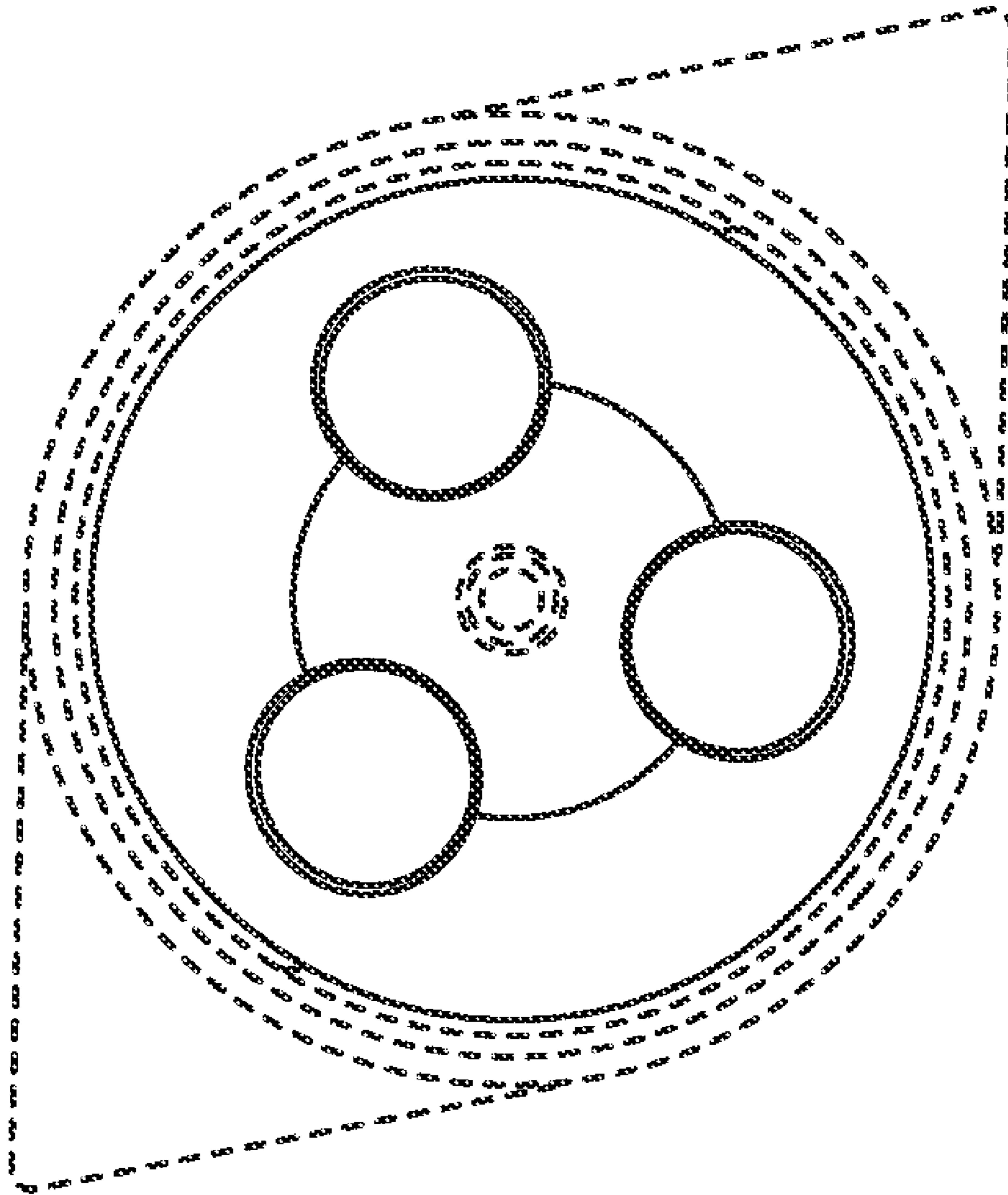

FIG. 6