



US00D631191S

(12) **United States Design Patent**
Luo

(10) **Patent No.:** **US D631,191 S**
(45) **Date of Patent:** **** Jan. 18, 2011**

(54) **LIGHTER SHELL**

(76) Inventor: **Xing Wen Luo**, 15277 Don Julian Rd.,
City of Industry, CA (US) 91745

(**) Term: **14 Years**

(21) Appl. No.: **29/348,261**

(22) Filed: **Dec. 15, 2009**

(51) **LOC (9) Cl.** **27-05**

(52) **U.S. Cl.** **D27/161**

(58) **Field of Classification Search** D27/139,
D27/141, 154-160; 131/185, 234, 249; D7/416,
D7/417; 431/129, 143, 153, 253-256, 273-277
See application file for complete search history.

(56) **References Cited**

U.S. PATENT DOCUMENTS

D136,980	S	*	1/1944	Hickman	D27/160
5,447,430	A	*	9/1995	Kim et al.	431/126
D378,442	S	*	3/1997	Ichikawa	D27/186
D378,622	S	*	3/1997	Dimopoulos	D27/144
D410,564	S	*	6/1999	Sher	D27/156
D429,025	S	*	8/2000	Maruyama	D27/141
D452,752	S	*	1/2002	Lee	D27/161
D529,229	S	*	9/2006	Debbas	D27/161
D533,683	S	*	12/2006	Ruan	D27/154
D548,395	S	*	8/2007	Luo	D27/154
D548,397	S	*	8/2007	Luo	D27/158
D548,882	S	*	8/2007	Luo	D27/158
D548,883	S	*	8/2007	Lin	D27/161
D552,791	S	*	10/2007	Toffler	D27/161

D553,292	S	*	10/2007	Lin	D27/161
D563,041	S	*	2/2008	Luo	D27/161
D566,889	S	*	4/2008	Luo	D27/161

* cited by examiner

Primary Examiner—Stella M Reid

Assistant Examiner—Keli L Hill

(74) *Attorney, Agent, or Firm*—Raymond Y. Chan; David and Raymond Patent Firm

(57) **CLAIM**

The ornamental design for a lighter shell, as shown and described.

DESCRIPTION

FIG. 1 is a front perspective view of lighter shell showing my new design.

FIG. 2 is a right view thereof.

FIG. 3 is a left view thereof.

FIG. 4 is a front view thereof.

FIG. 5 is a rear view thereof.

FIG. 6 is a top view thereof.

FIG. 7 is a bottom view thereof; and,

FIG. 8 is a top perspective view thereof.

The broken lines shown are included for the purpose of illustrating the unclaimed portions of the article and form no part of the claim.

1 Claim, 8 Drawing Sheets

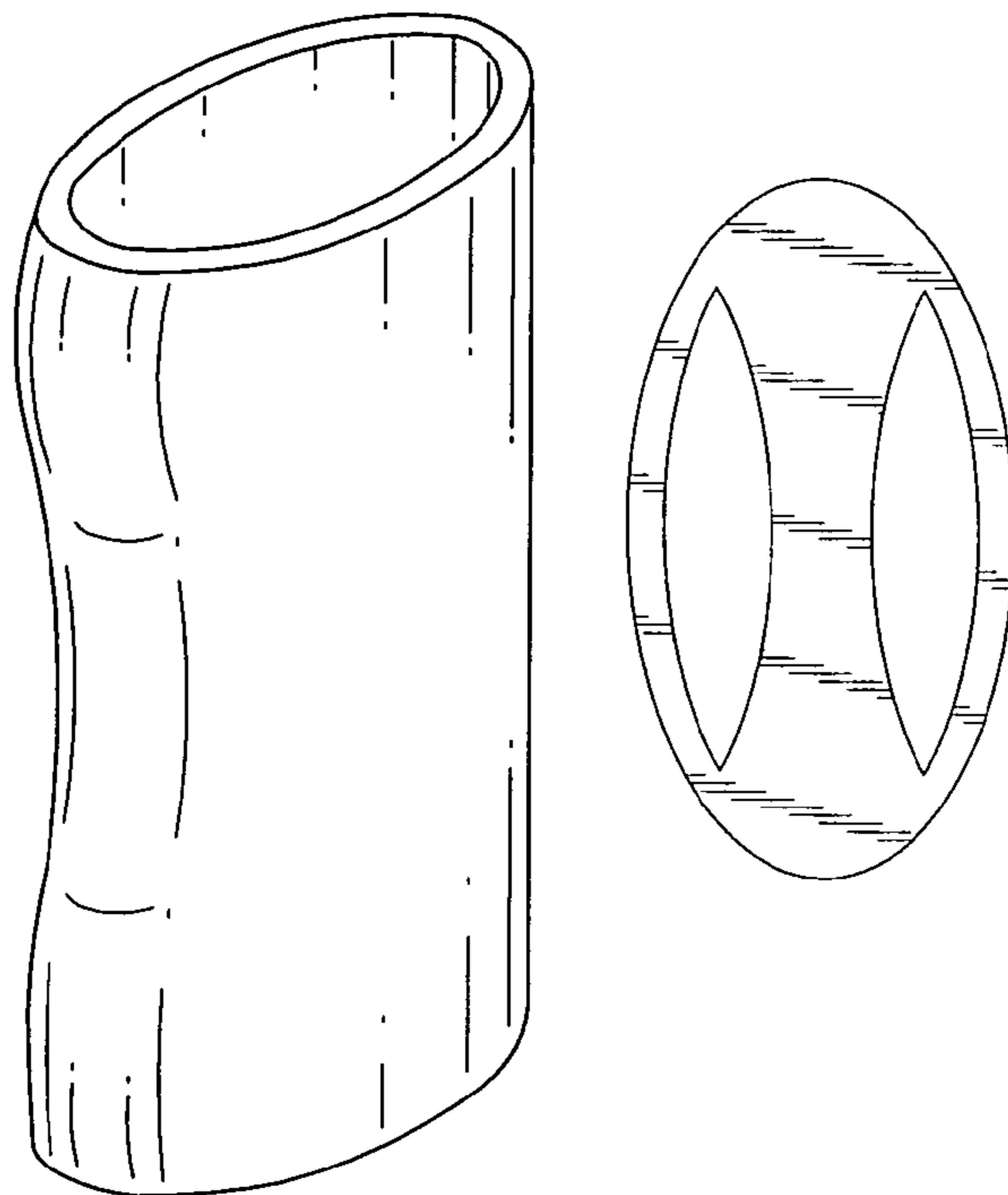

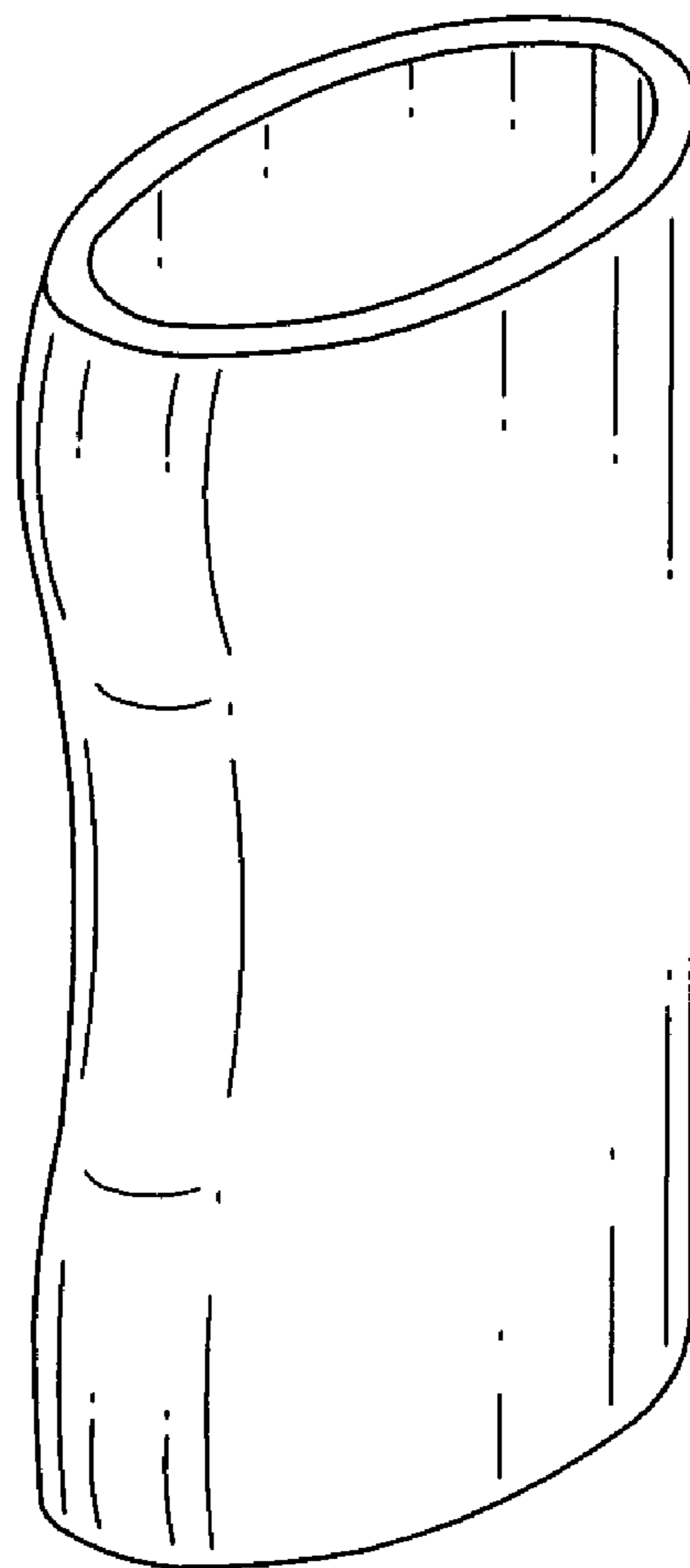

FIG. 1

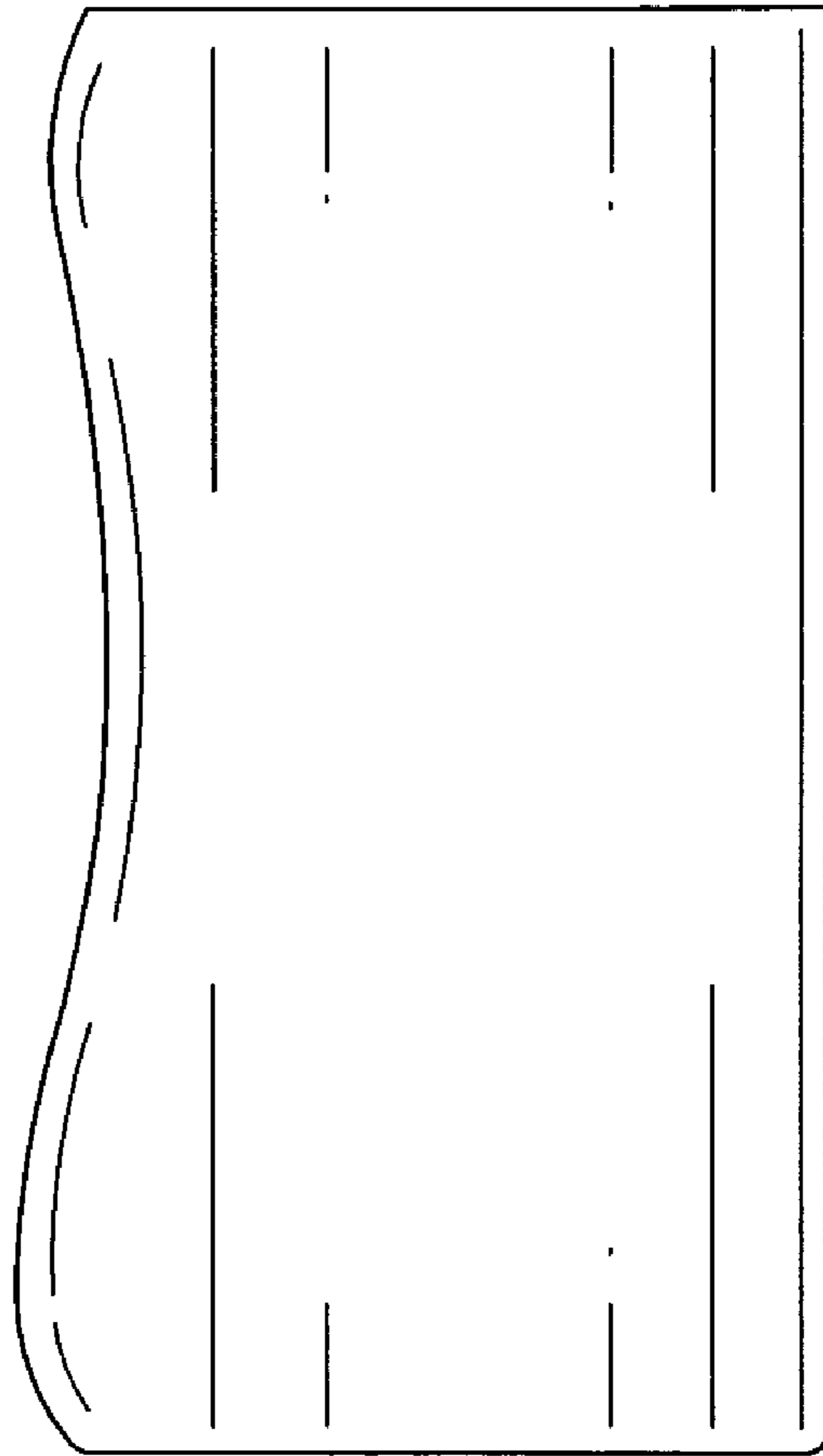

FIG. 2

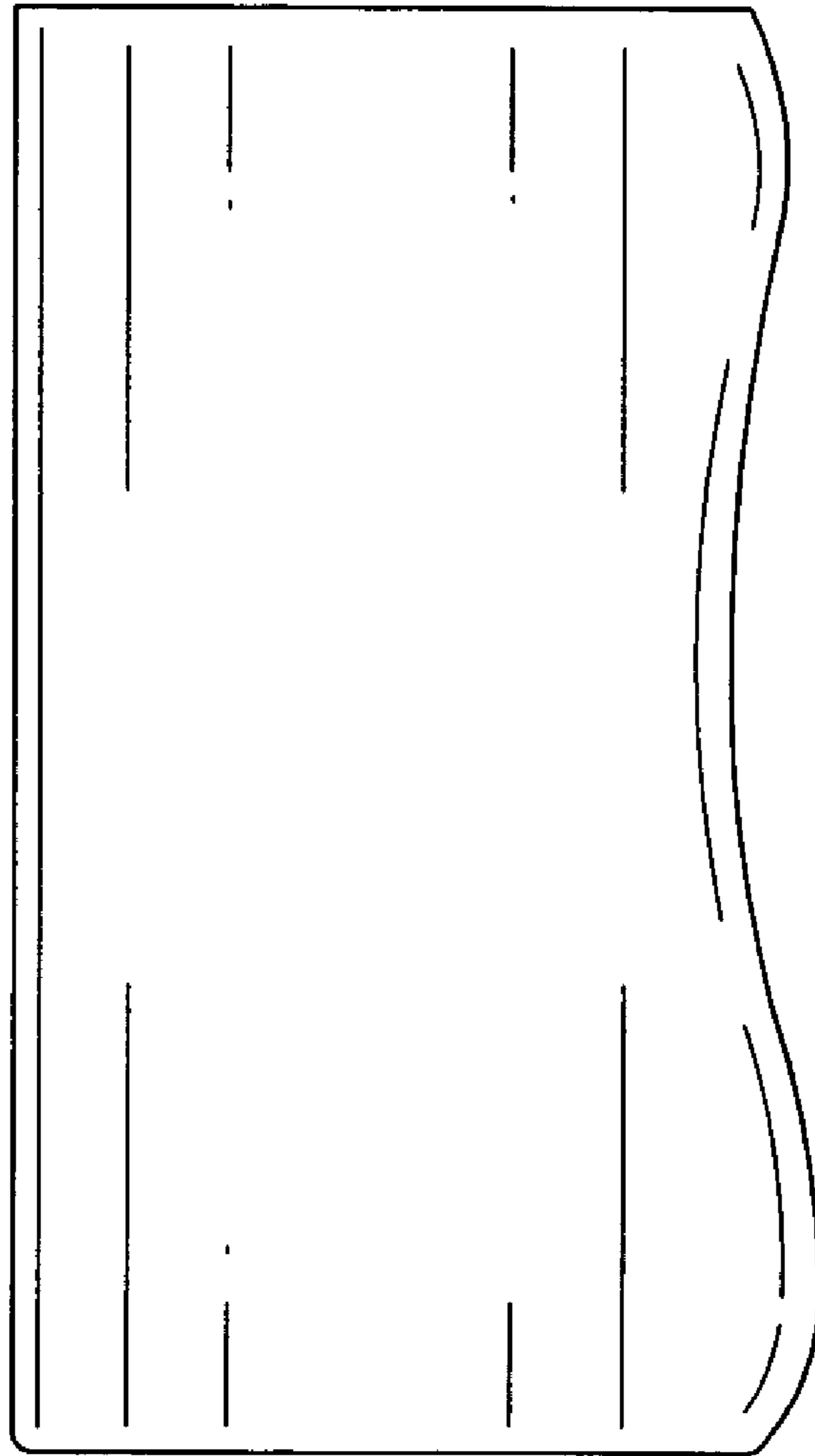

FIG. 3

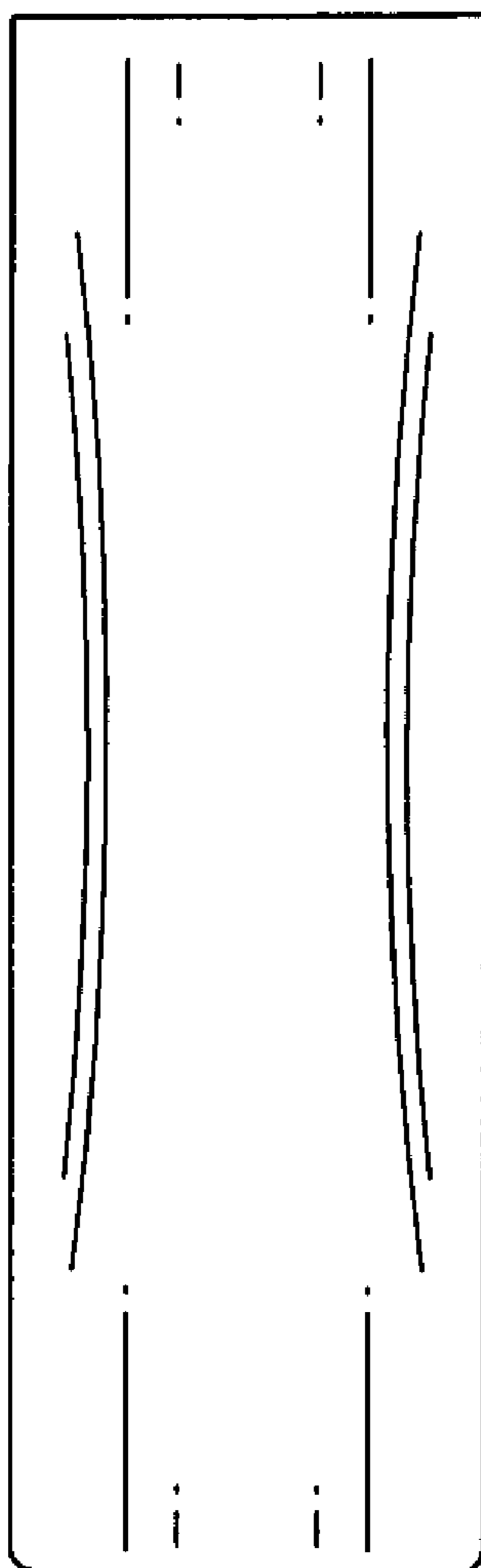

FIG. 4

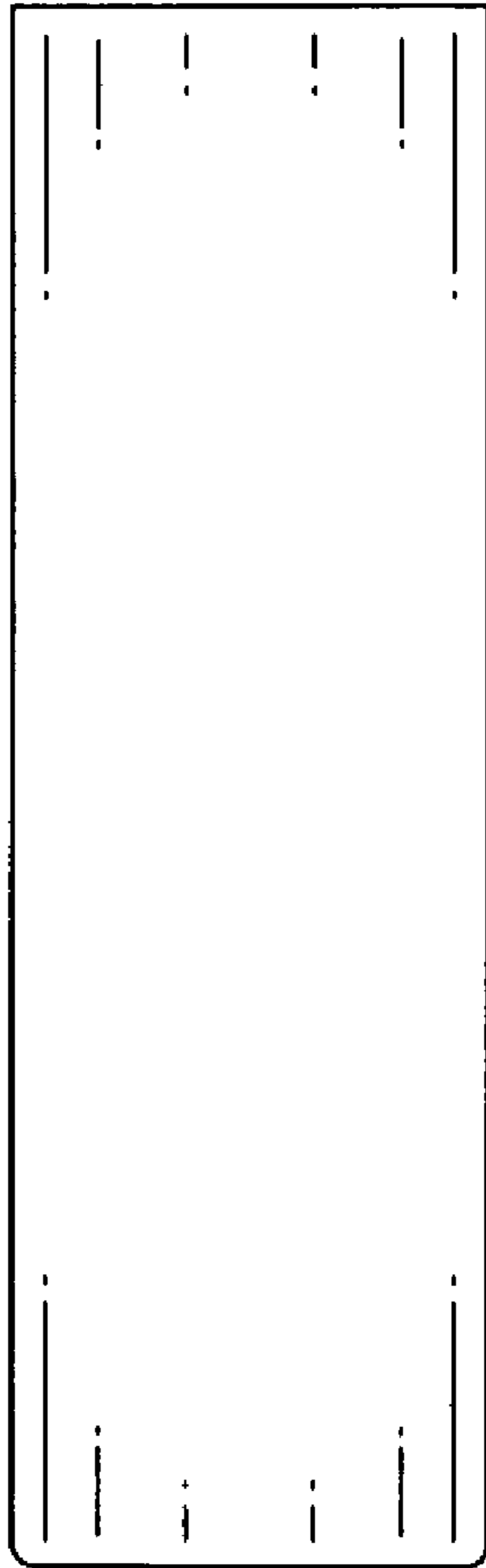

FIG. 5

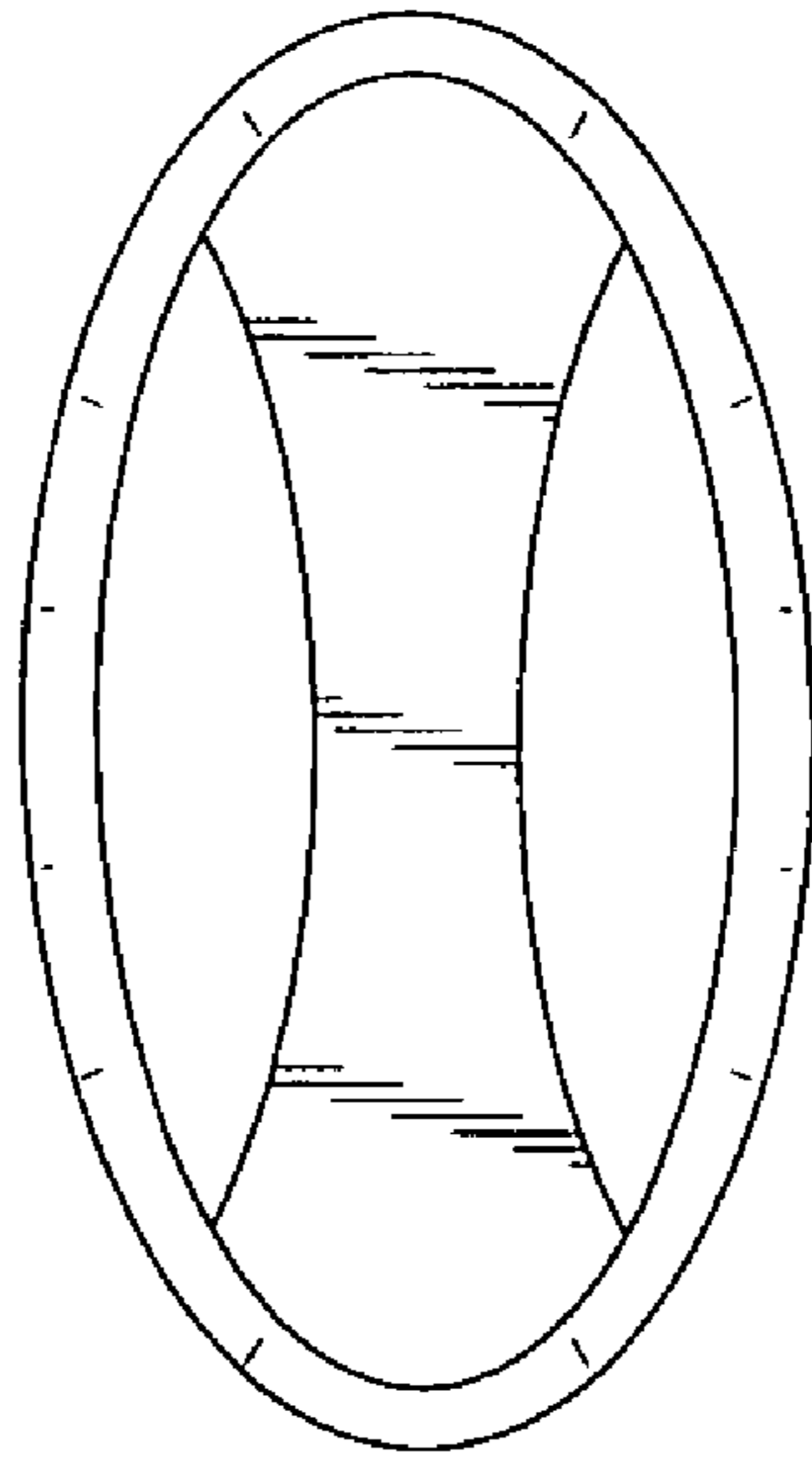

FIG. 6

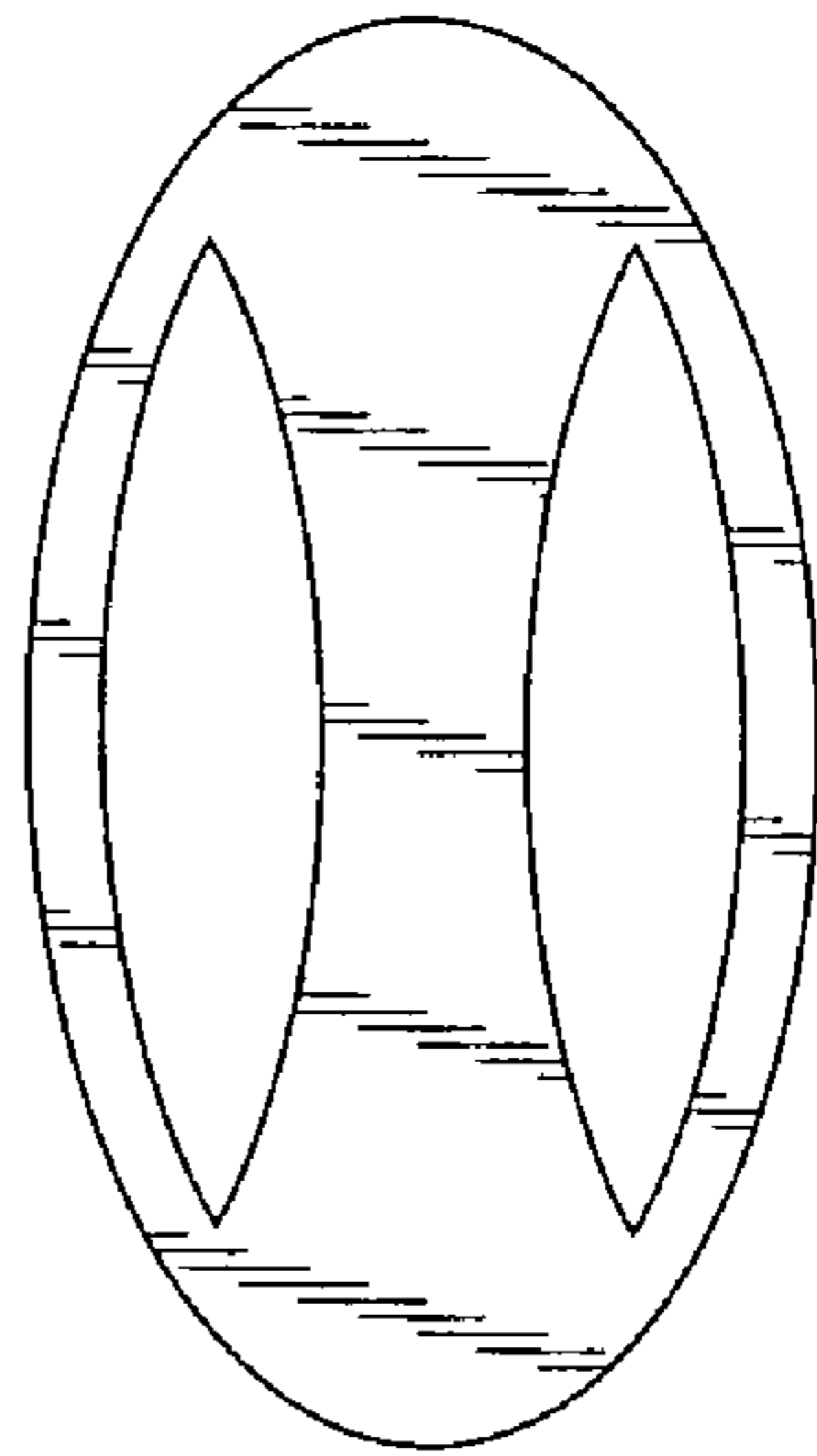

FIG. 7

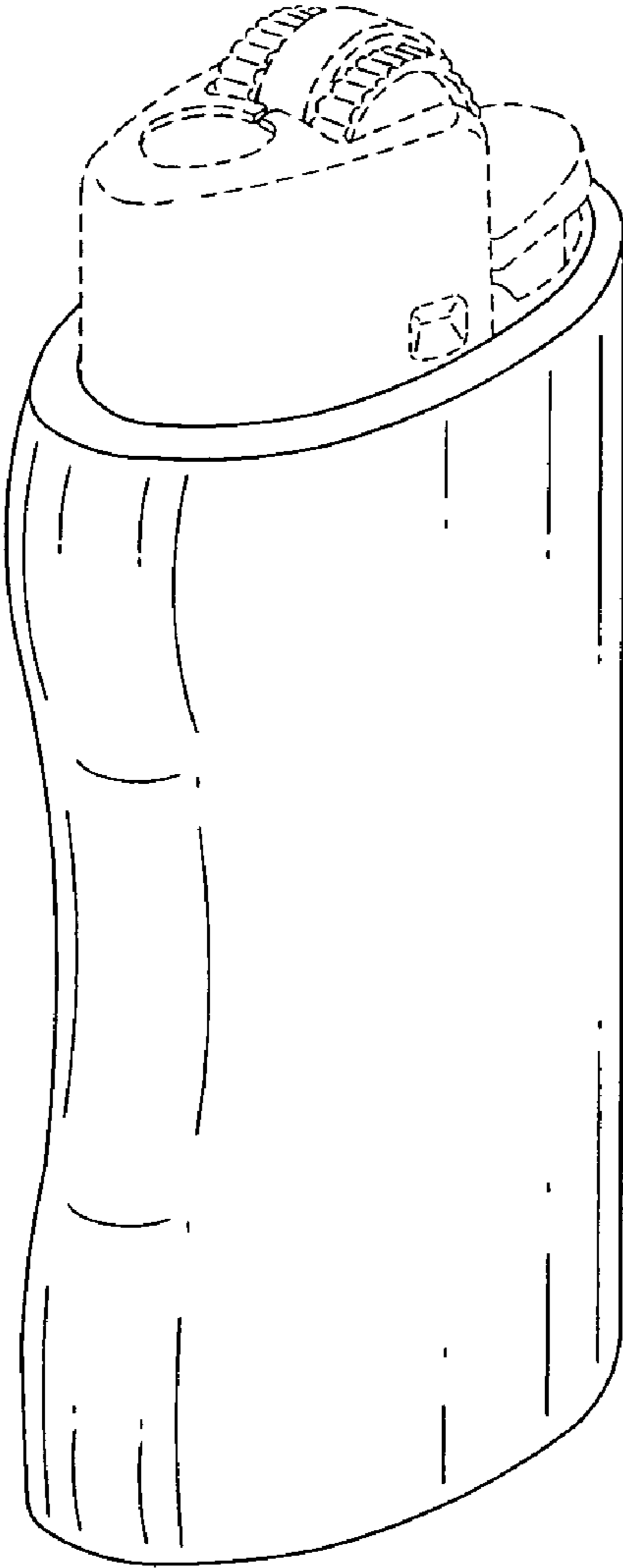

FIG. 8