

US00D631177S

(12) **United States Design Patent**  
**Yang**

(10) **Patent No.:** **US D631,177 S**  
(45) **Date of Patent:** **\*\* Jan. 18, 2011**

(54) **AUTOMOBILE LAMP**

(76) Inventor: **Hsiu-Pen Yang**, No 427 Se. 2, Wenhua Road, Panchiao, Taipei (TW)

(\*\*) Term: **14 Years**

(21) Appl. No.: **29/370,649**

(22) Filed: **Aug. 18, 2010**

(51) **LOC (9) Cl.** ..... **26-06**

(52) **U.S. Cl.** ..... **D26/28**

(58) **Field of Classification Search** ..... D26/28-36;  
362/459-468, 475-478, 485-487  
See application file for complete search history.

(56) **References Cited**

**U.S. PATENT DOCUMENTS**

D549,363 S *	8/2007	Pfeiffer	.....	D26/28
D552,769 S *	10/2007	Leclercq	.....	D26/28
D553,268 S *	10/2007	Pfeiffer	.....	D26/28
D561,357 S *	2/2008	Leclercq	.....	D26/28
D565,211 S *	3/2008	Haller et al.	.....	D26/28

\* cited by examiner

*Primary Examiner*—Marcus A Jackson

(74) *Attorney, Agent, or Firm*—Law Offices of Roger C. Hsu; Charles R. Sutton

(57) **CLAIM**

The ornamental design for an automobile lamp, as shown and described.

**DESCRIPTION**

FIG. 1 is a perspective view of an automobile lamp showing my new design;

FIG. 2 is a front elevational view thereof;

FIG. 3 is a rear elevational view thereof;

FIG. 4 is a right side elevational view thereof;

FIG. 5 is a left side elevational view thereof;

FIG. 6 is a top plan view thereof; and,

FIG. 7 is a bottom plan view thereof.

**1 Claim, 7 Drawing Sheets**

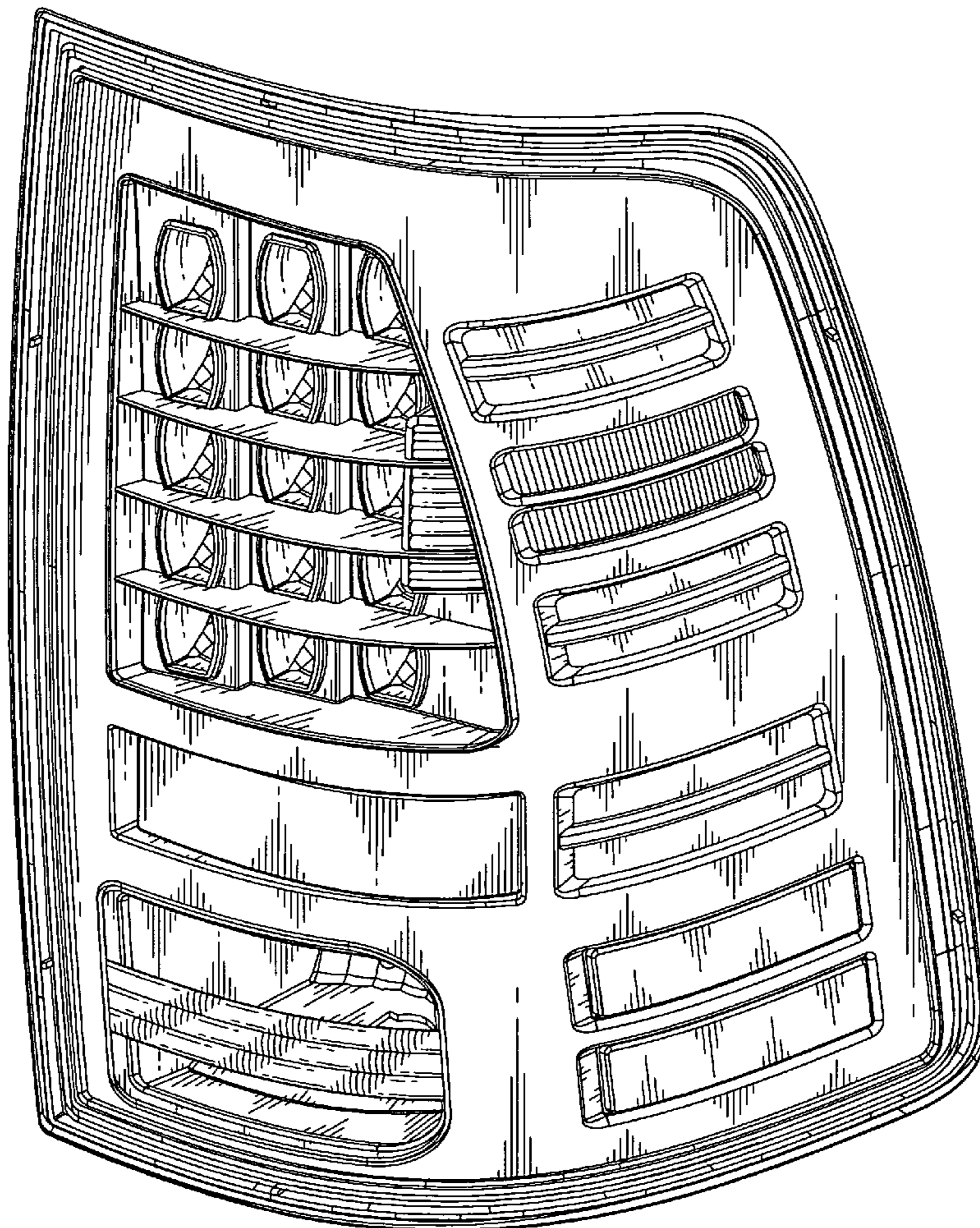

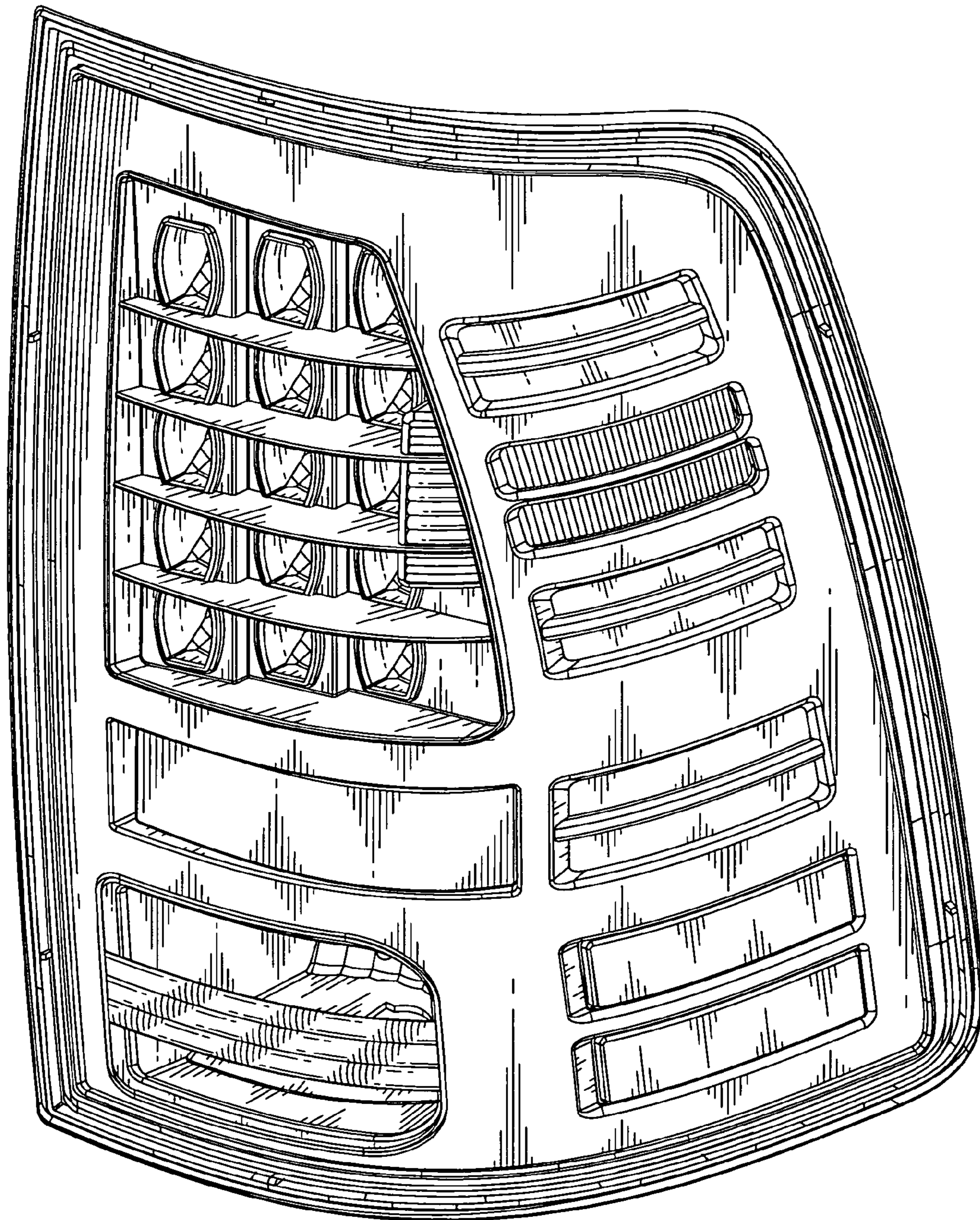

FIG. 1

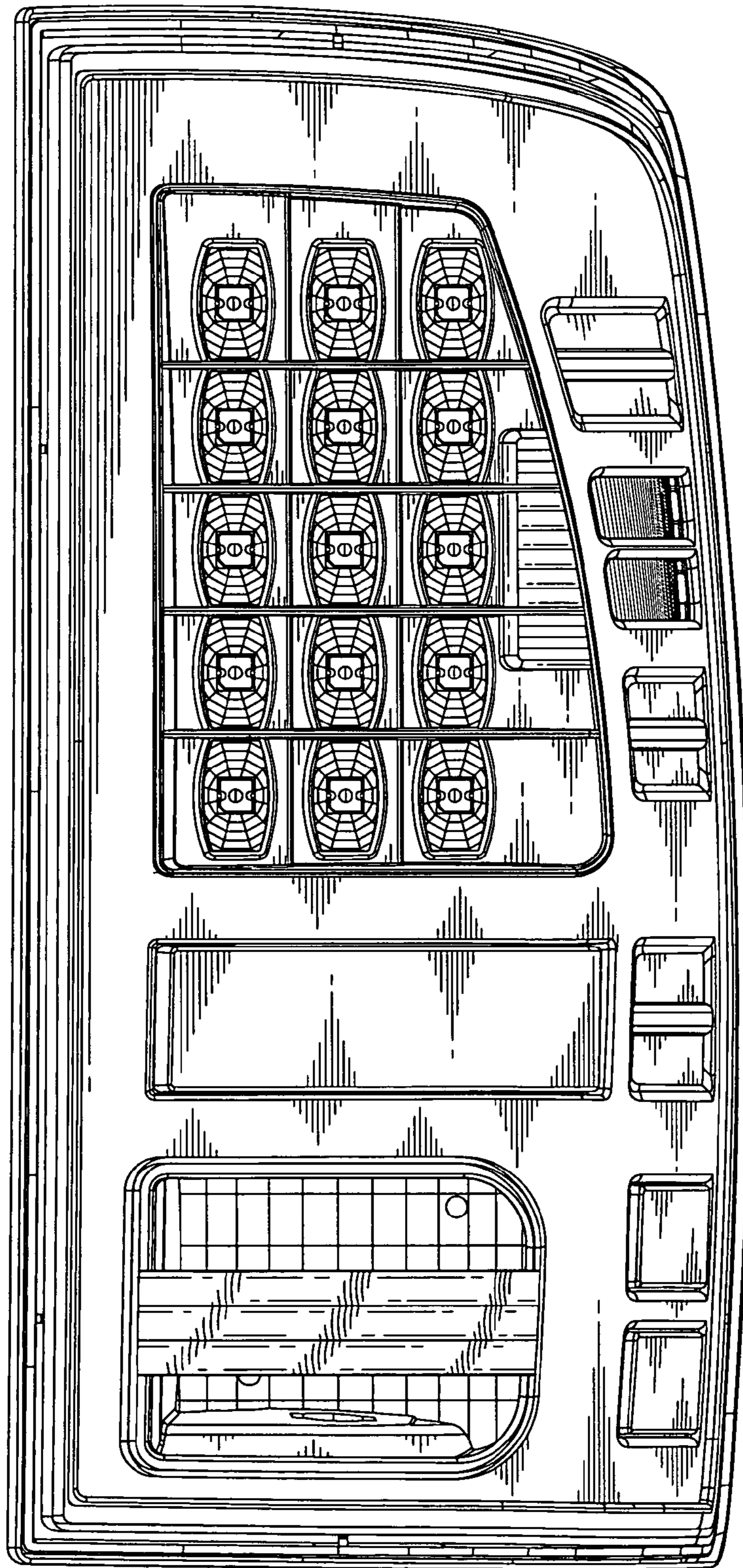

FIG. 2

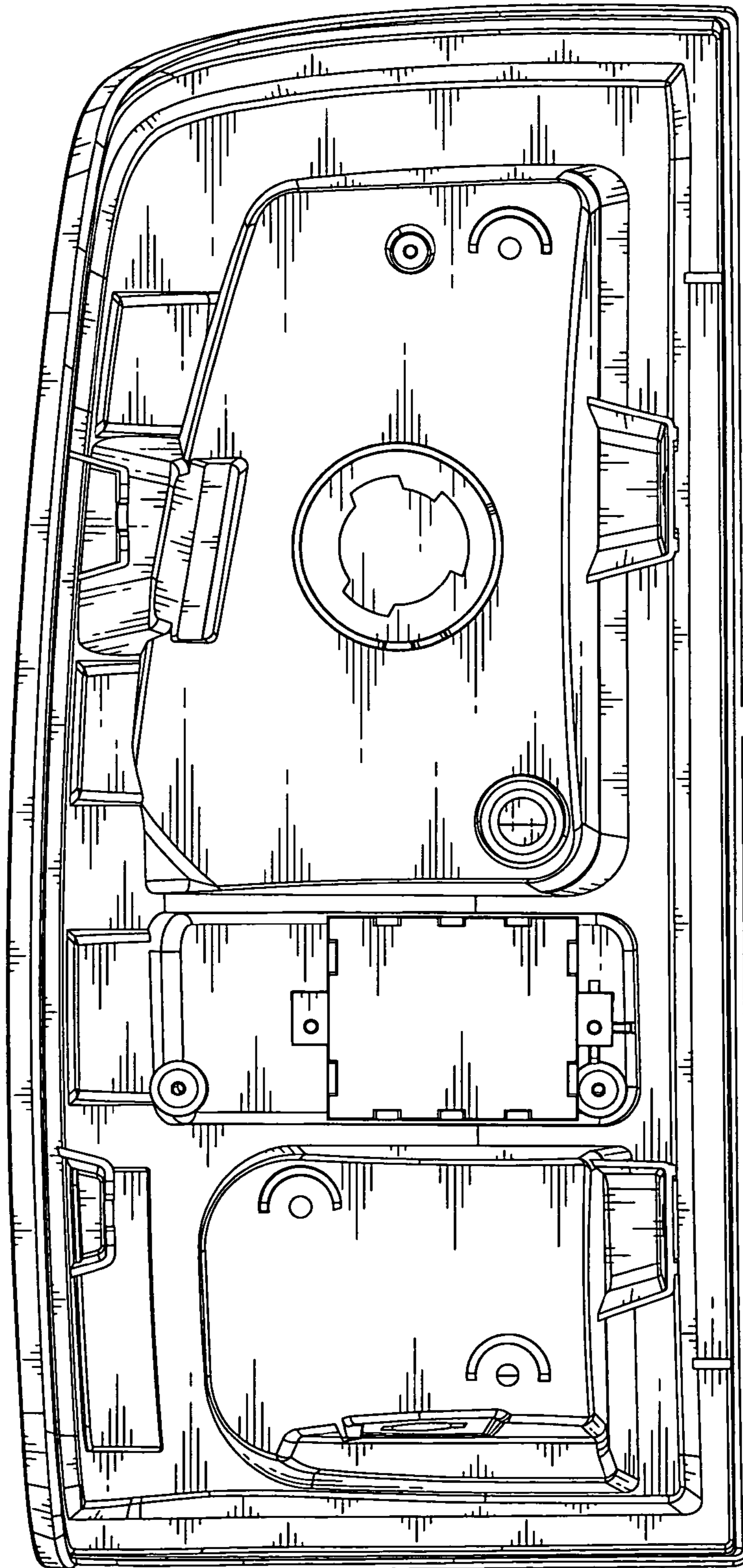

FIG. 3

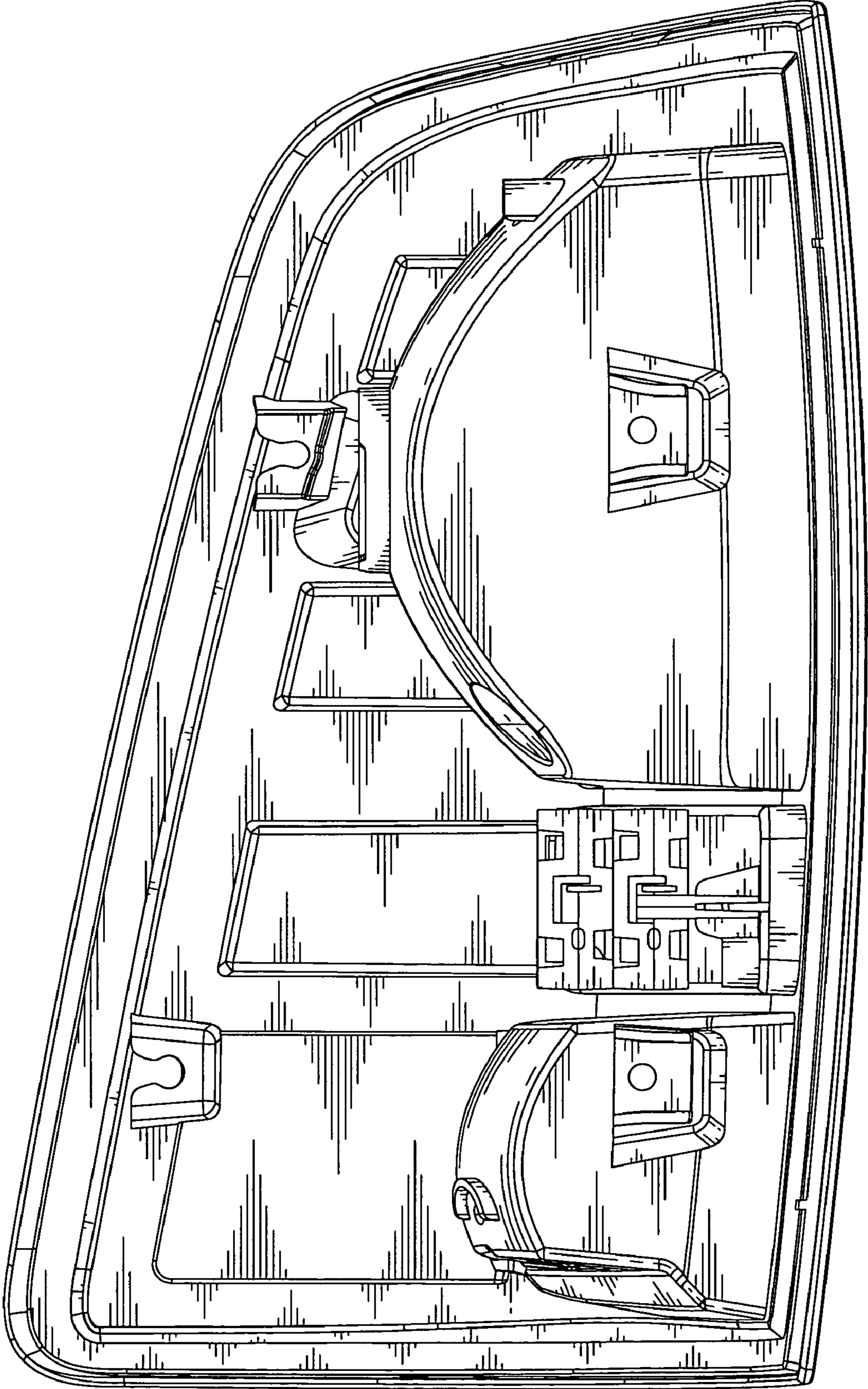

FIG. 4

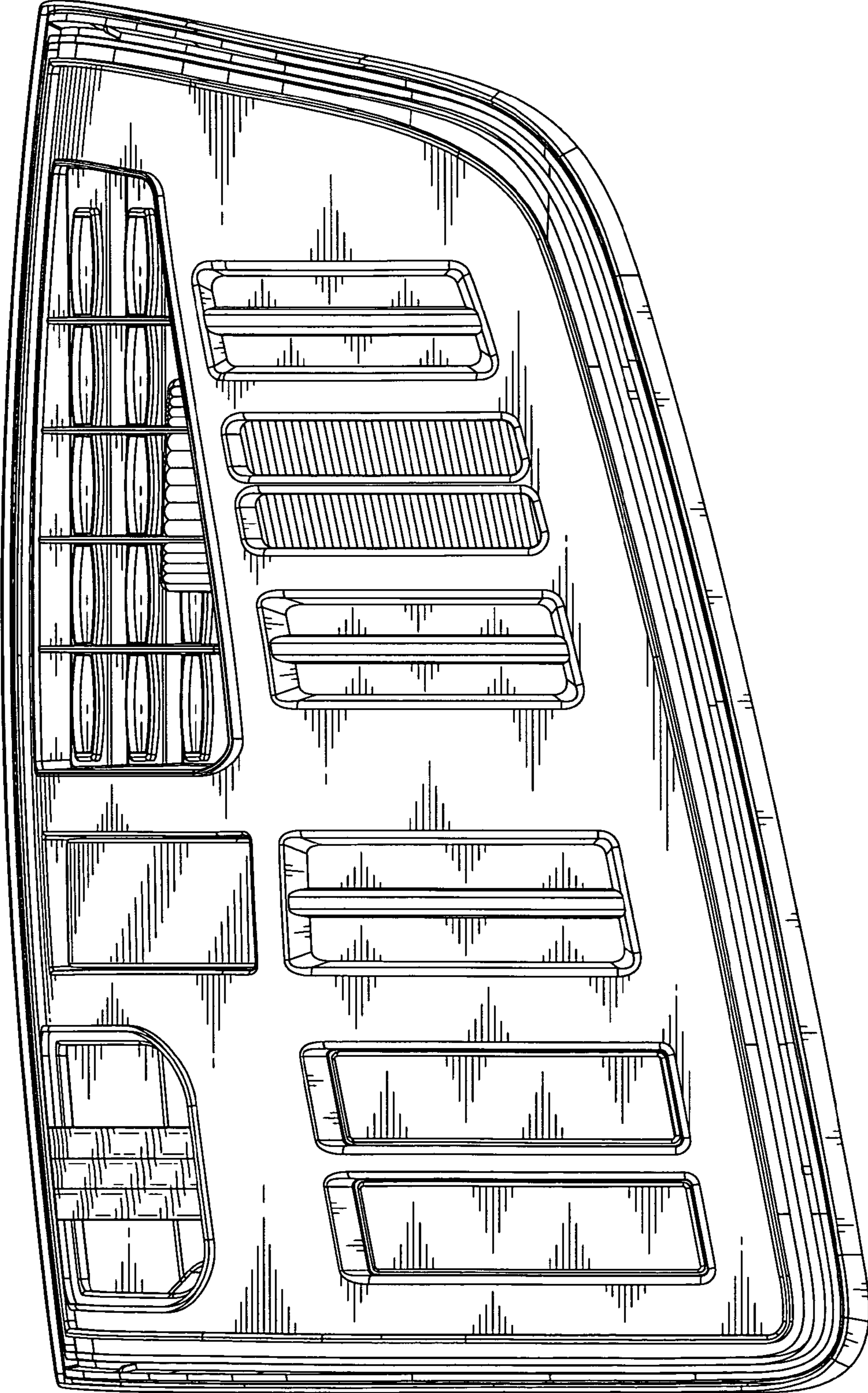

FIG. 5

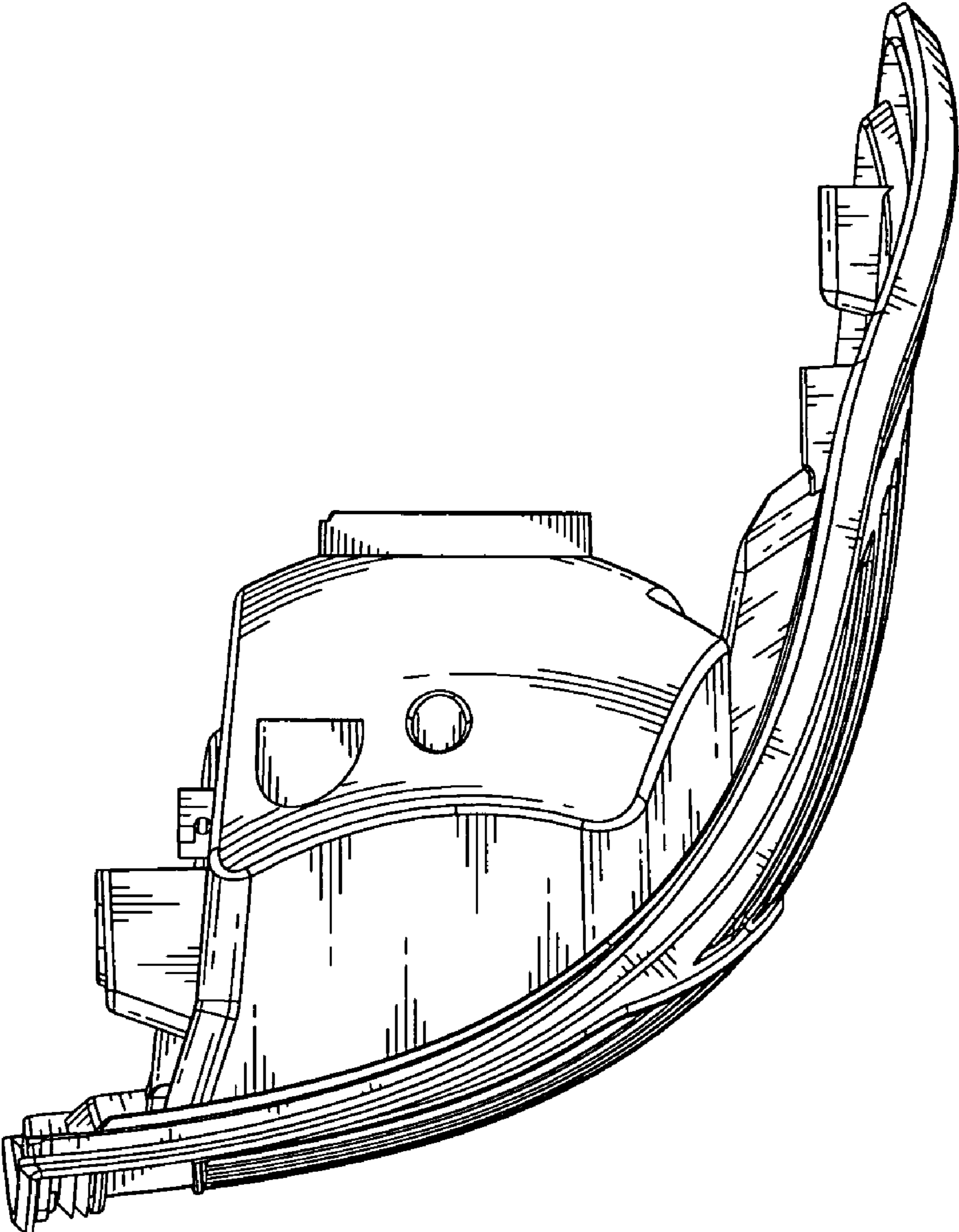

FIG. 6

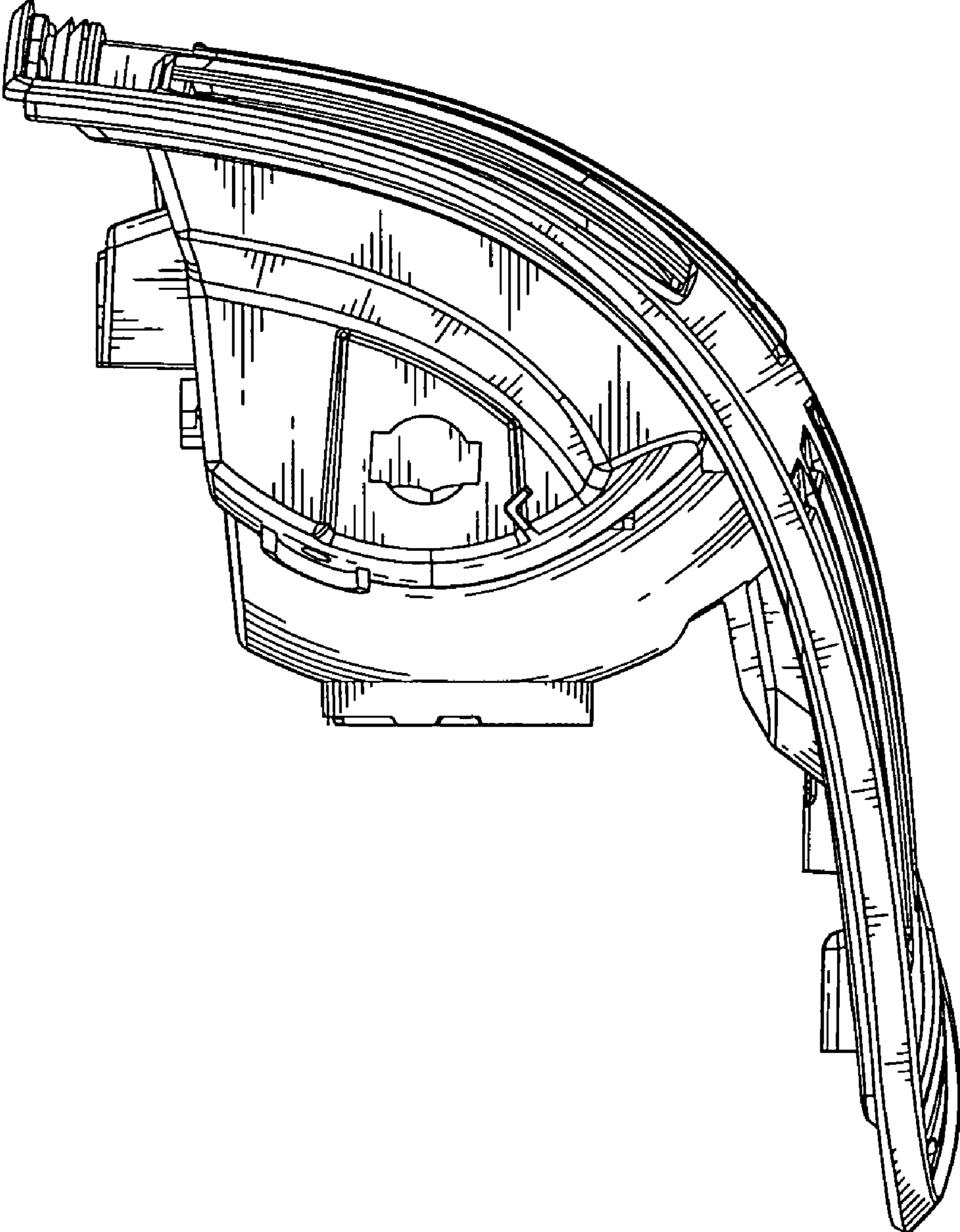

FIG. 7