



US00D631105S

(12) **United States Design Patent**
Cohen et al.

(10) **Patent No.:** **US D631,105 S**
(45) **Date of Patent:** **** Jan. 18, 2011**

(54) **TOY CASTLE CONVERTIBLE INTO A TABLE AND CHAIR SET**

D380,519 S * 7/1997 van Huystee D21/814
D389,892 S * 1/1998 Van Wageningen D21/827

(75) Inventors: **Ronald B. Cohen**, Hopkinton, MA (US);
Robert J. Pagano, Cumberland, RI (US); **Lawrence Alan Weckstein**,
Lyndhurst, NJ (US)

(Continued)

Primary Examiner—Cynthia M Chin
(74) *Attorney, Agent, or Firm*—Iandiorio Teska & Coleman

(73) Assignee: **Kids Only, Inc.**, Westborough, MA (US)

(57) **CLAIM**

(**) Term: **14 Years**

The ornamental design for the toy castle convertible into a table and chair set, as shown and described.

(21) Appl. No.: **29/348,567**

DESCRIPTION

(22) Filed: **Jan. 20, 2010**

FIG. 1 is a front perspective view of a toy castle convertible into a table and chair set of this invention;

(51) **LOC (9) Cl.** **21-01**

(52) **U.S. Cl.** **D21/510; D6/337**

FIG. 2 is a front view of the toy castle configuration of this invention;

(58) **Field of Classification Search** D21/405,
D21/483, 506, 510, 814, 827; D6/337, 412,
D6/450, 451; D9/638, 641; D7/515; D11/157;
D30/112, 161; 446/71, 73, 110, 476–478,
446/482, 487, 488; D26/95

FIG. 3 is a right-side view of the toy castle of this invention;
FIG. 4 is a rear view of the toy castle of this invention;

See application file for complete search history.

FIG. 5 is a left-side view of the toy castle of this invention;

FIG. 6 is a top plan view of the toy castle of this invention;

FIG. 7 is a bottom plan view of the toy castle of this invention;

FIG. 8 is a perspective view of the toy castle when converted into a table and chair set of this invention;

(56) **References Cited**

U.S. PATENT DOCUMENTS

- D132,904 S * 6/1942 Buckingham D9/638
- D154,199 S * 6/1949 Finkelstein D6/412
- D169,888 S * 6/1953 Beyer D21/510
- D188,135 S * 6/1960 Koenig D9/638
- D199,042 S * 9/1964 Douglas D9/638
- D247,385 S * 2/1978 Rideau D21/405
- 4,419,840 A * 12/1983 Pope 446/110
- D333,328 S * 2/1993 Aker et al. D21/510
- D342,697 S * 12/1993 Delson D11/157
- D367,694 S * 3/1996 van Huystee D21/510
- D368,393 S * 4/1996 Darneille D6/451
- D372,056 S * 7/1996 Norton D21/510

FIG. 9 is a top plan view of the table and chair set of this invention;

FIG. 10 is a bottom plan view of the table and chair set of this invention; and,

FIG. 11 is a front view of the table and chair set, a left-side and right-side view being a mirror image thereto with exception to the broken line disclosure.

The broken lines are for illustrative purposes only and form no part of the claimed design.

1 Claim, 10 Drawing Sheets

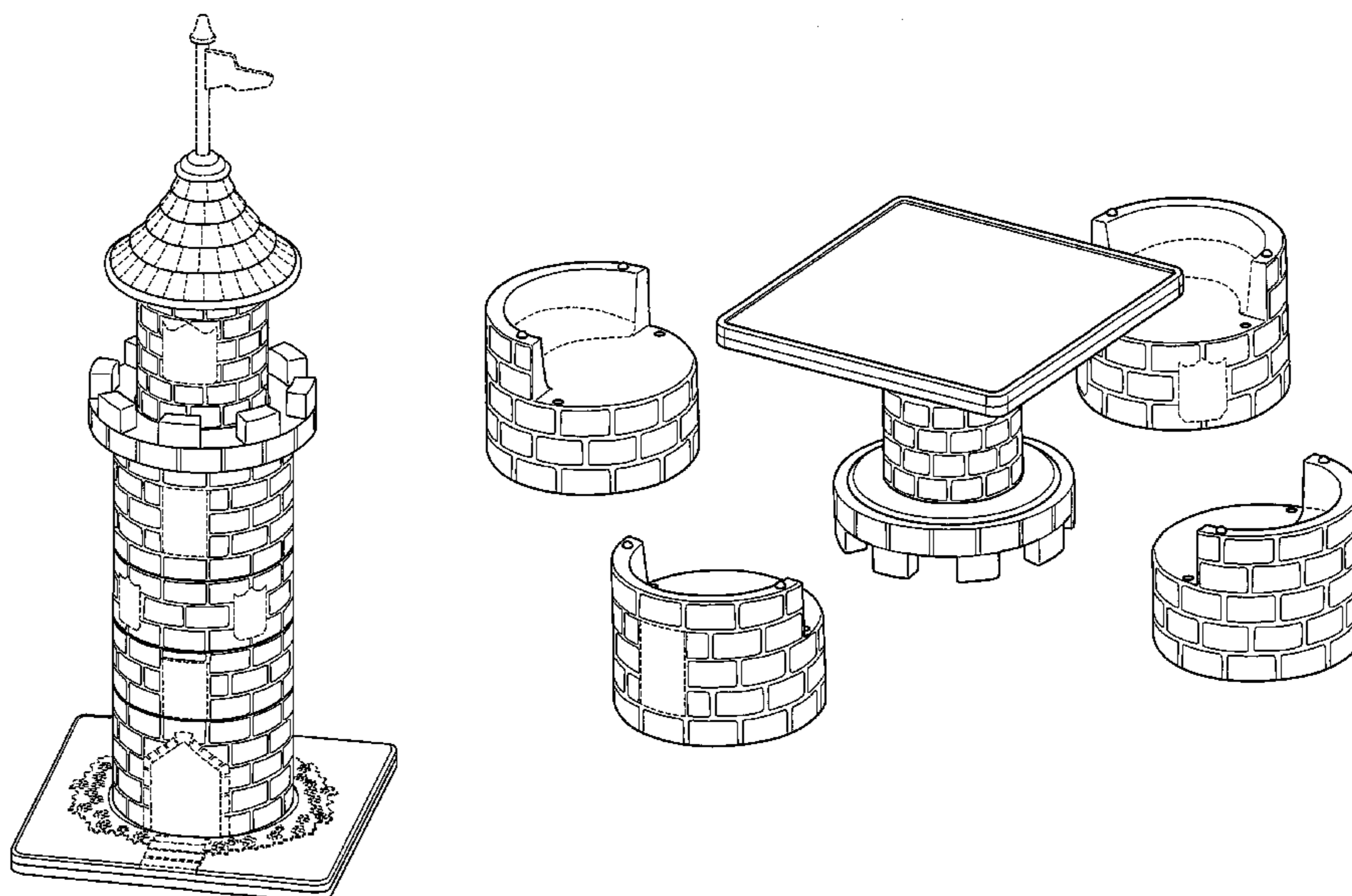

US D631,105 S

Page 2

U.S. PATENT DOCUMENTS

D393,303 S *	4/1998	Van Wagenen	D21/827	D501,584 S *	2/2005	Abajian	D30/161
D407,861 S *	4/1999	Teng	D30/112	D544,926 S *	6/2007	Kassens	D21/506
D417,745 S *	12/1999	Oddo	D26/95	D545,924 S *	7/2007	Wilson et al.	D21/510
D433,544 S *	11/2000	Nesbit-Yontz	D30/161	7,252,107 B2 *	8/2007	Chu et al.	446/487
D466,007 S *	11/2002	Fabretti	D9/641	D554,060 S *	10/2007	Park	D30/112
D469,584 S *	1/2003	Shepherd	D30/112	D561,533 S *	2/2008	Martin	D7/515

* cited by examiner

FIG. 1

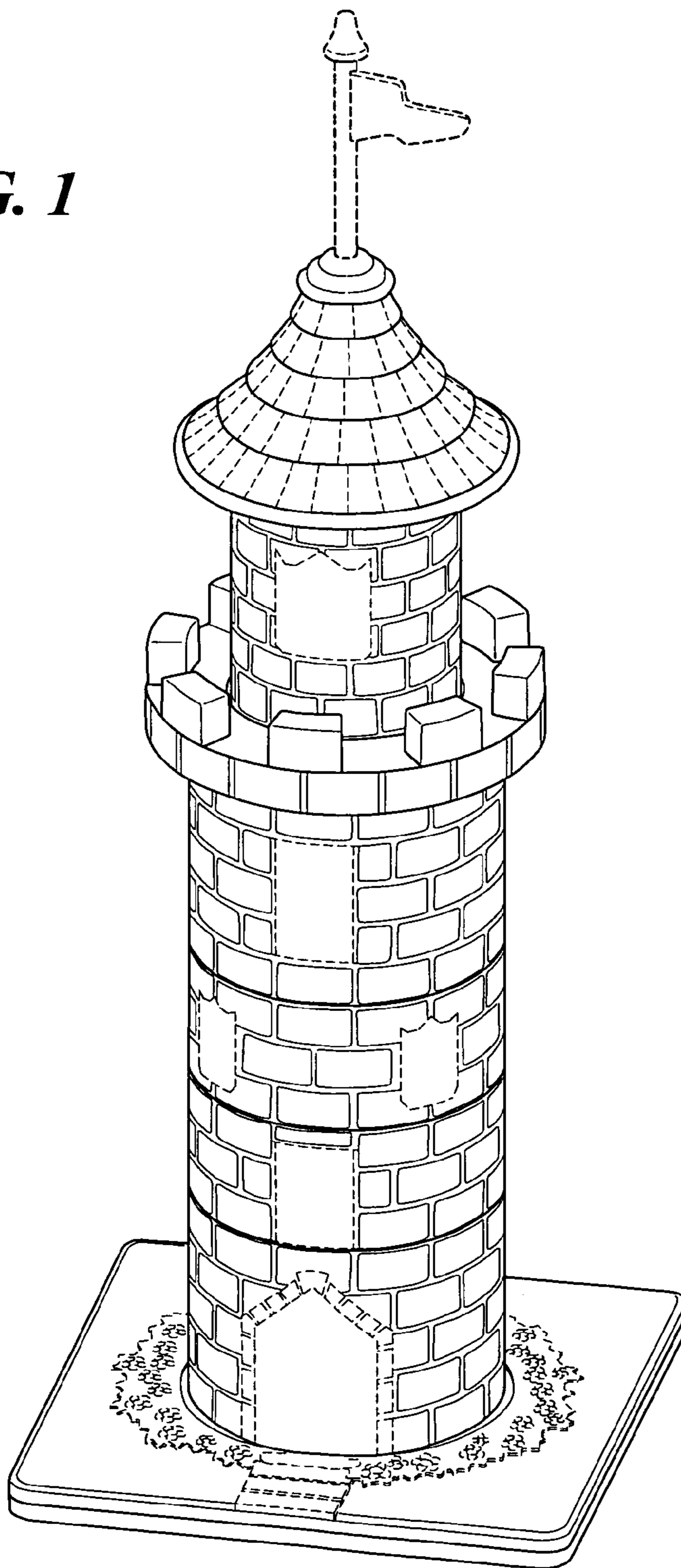

FIG. 2

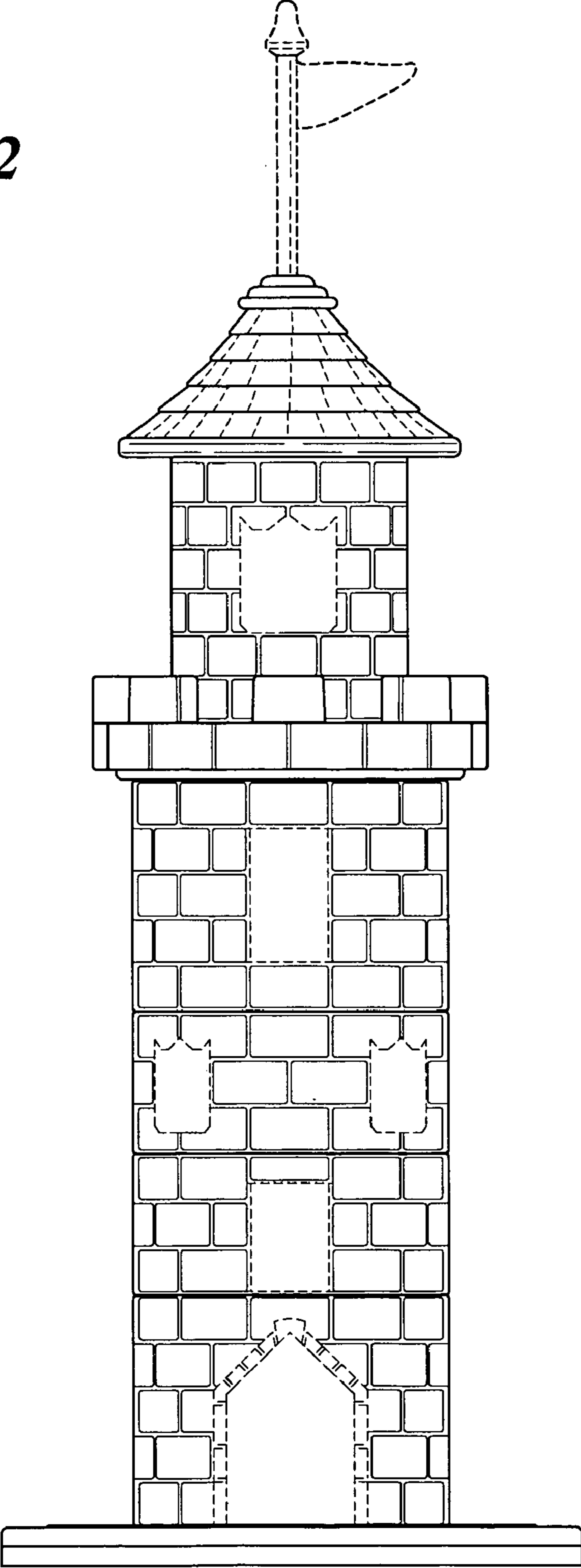

FIG. 3

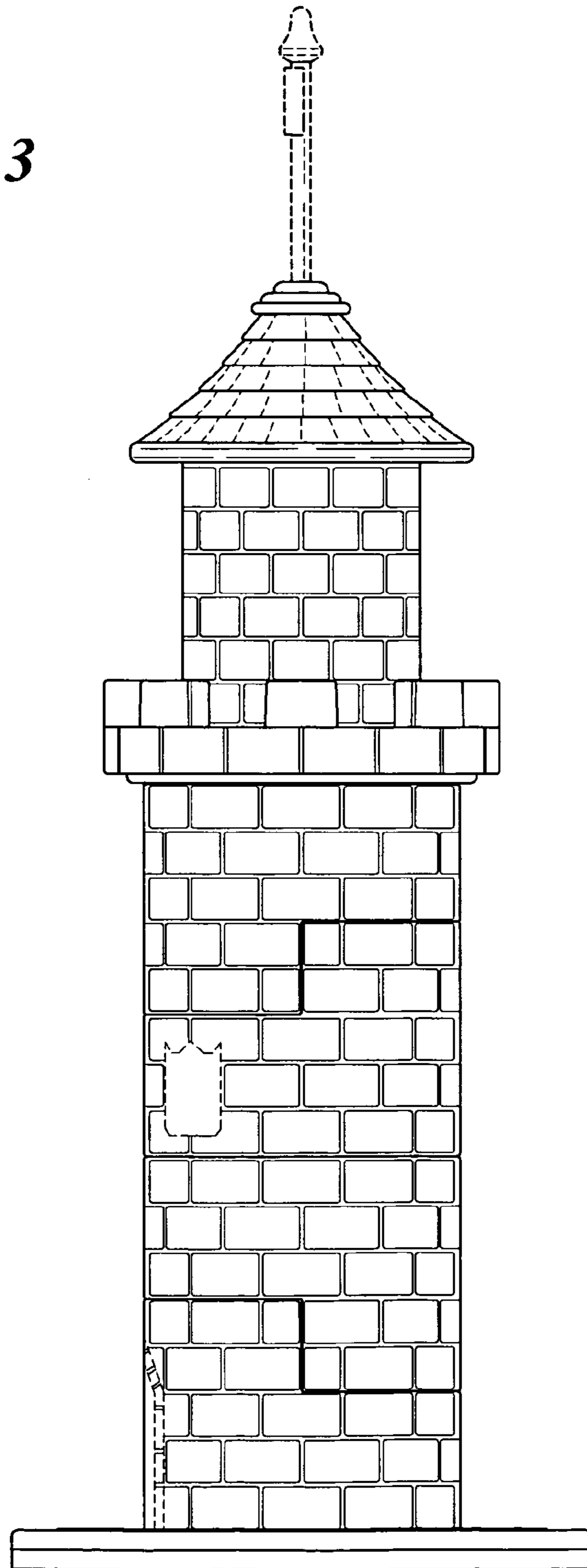

FIG. 4

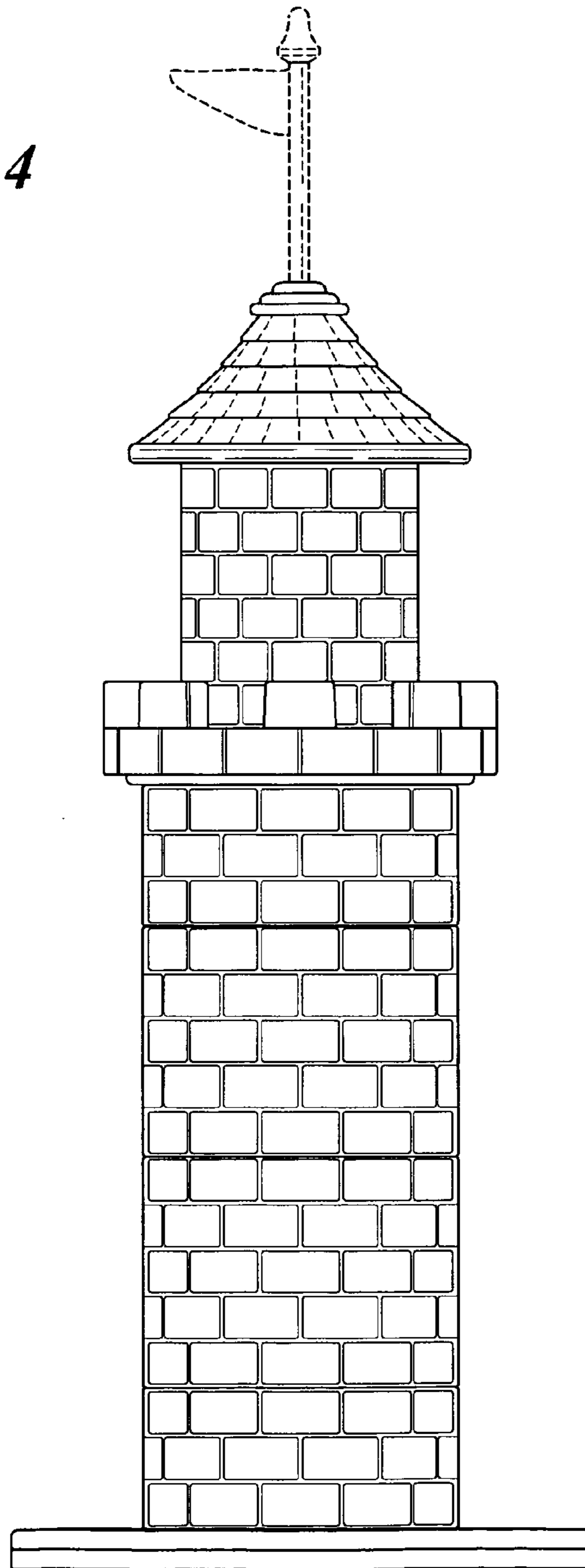
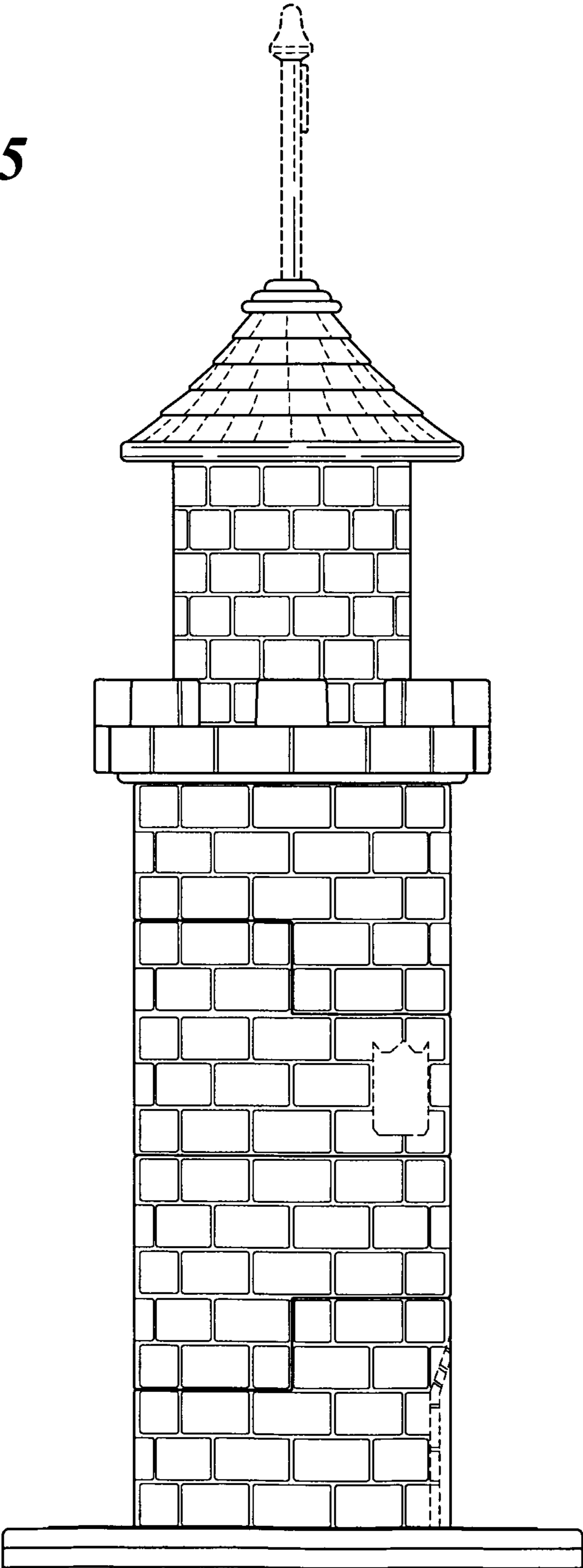

FIG. 5



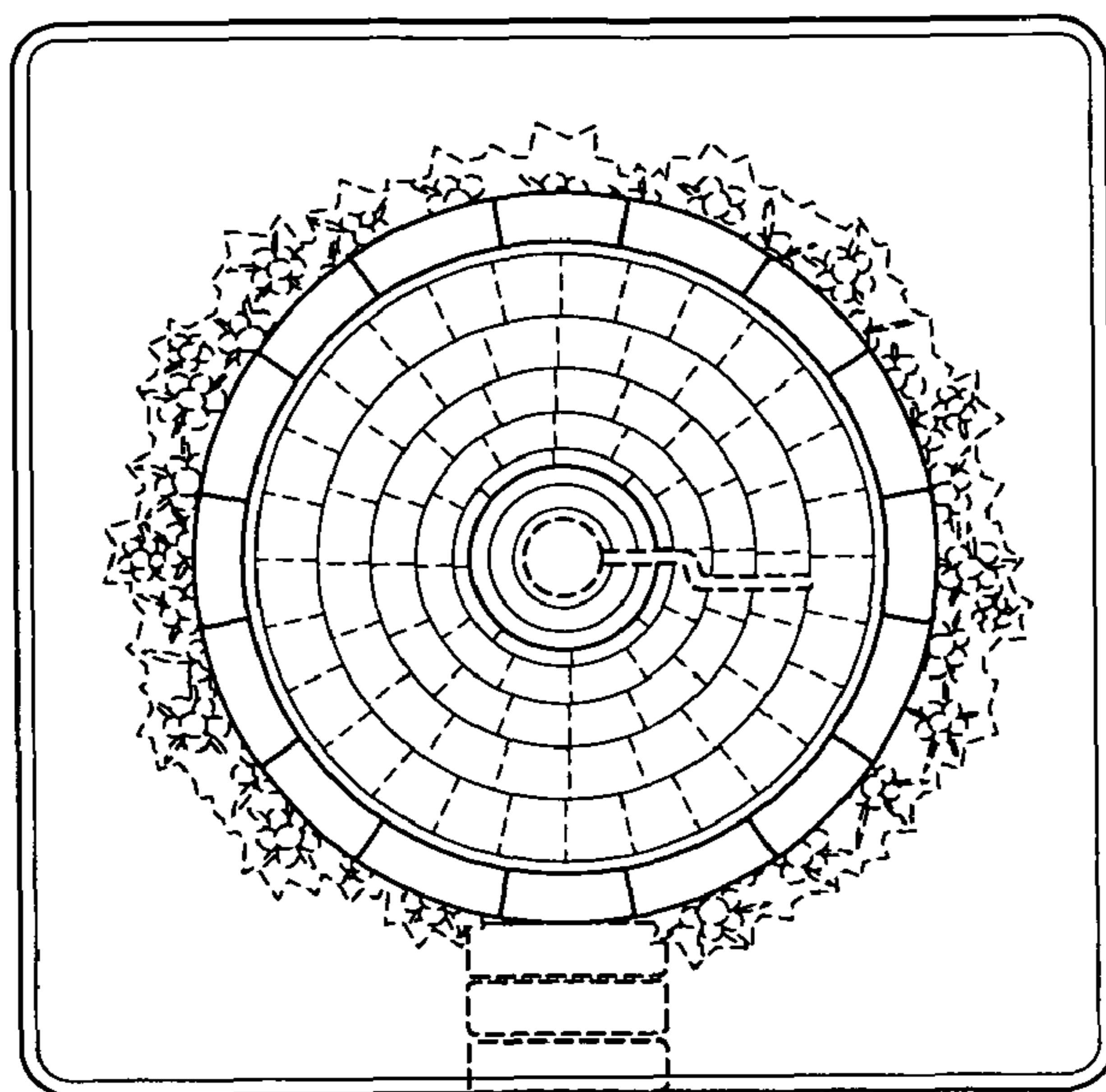

FIG. 6

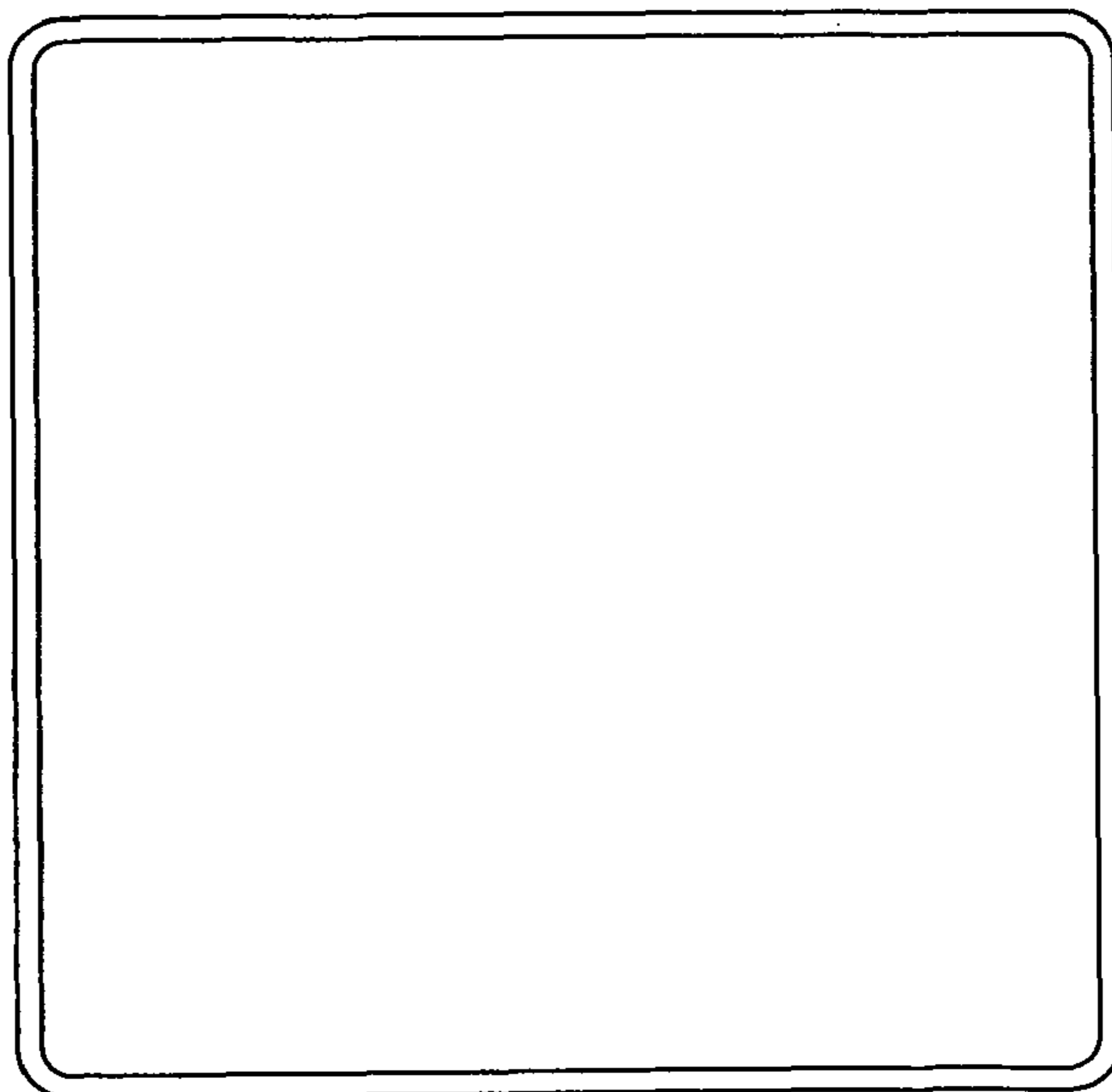

FIG. 7

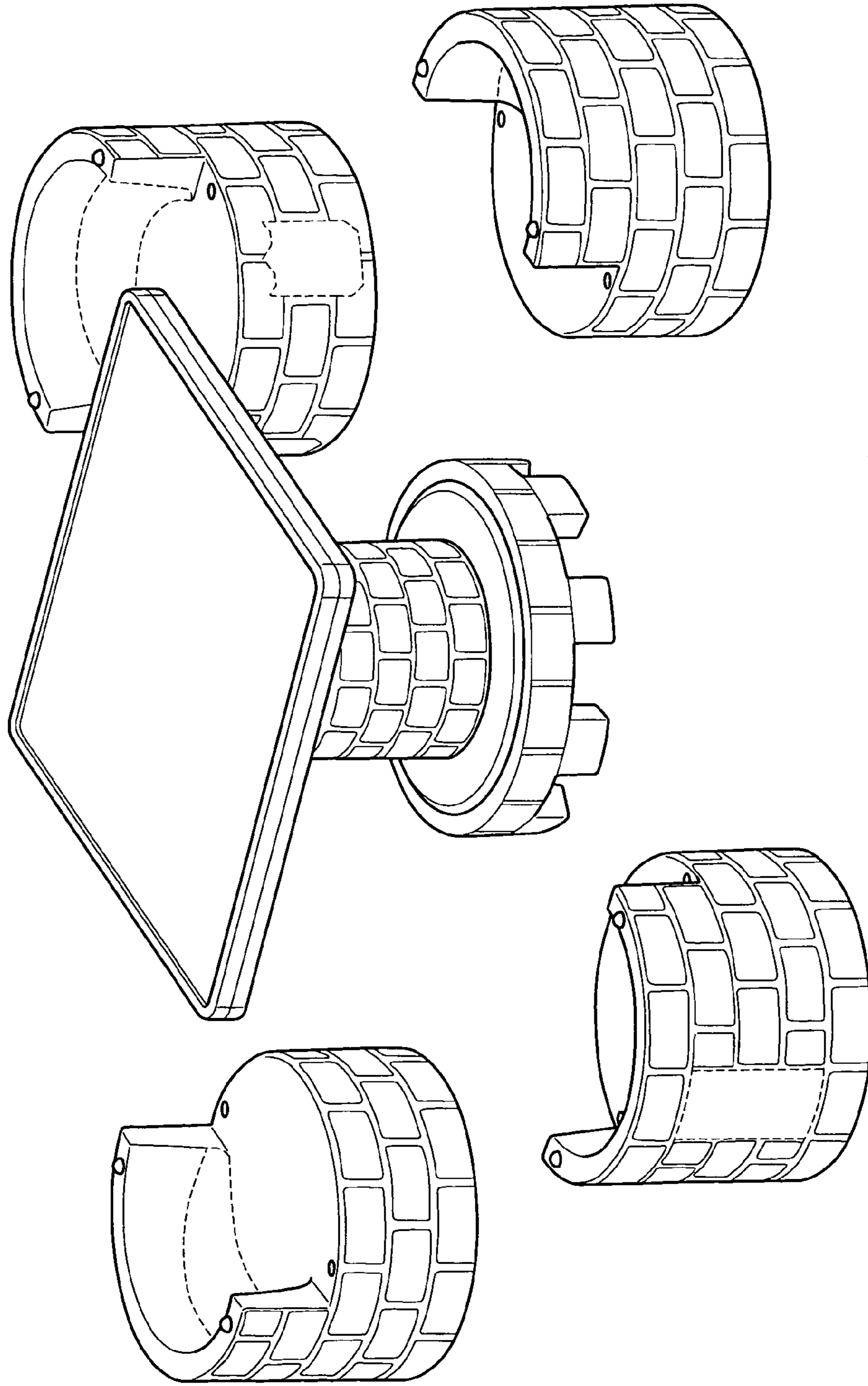

FIG. 8

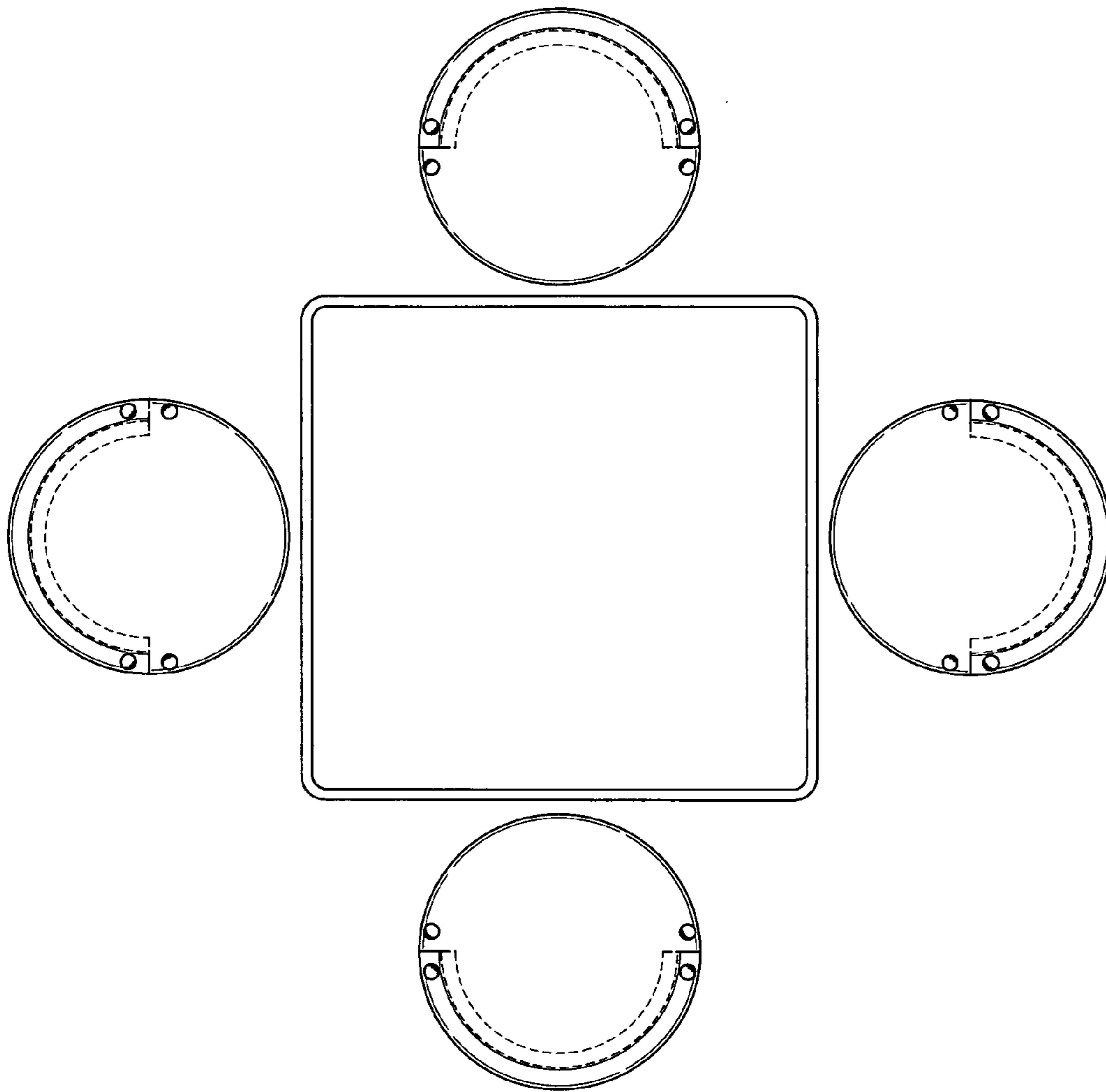

FIG. 9

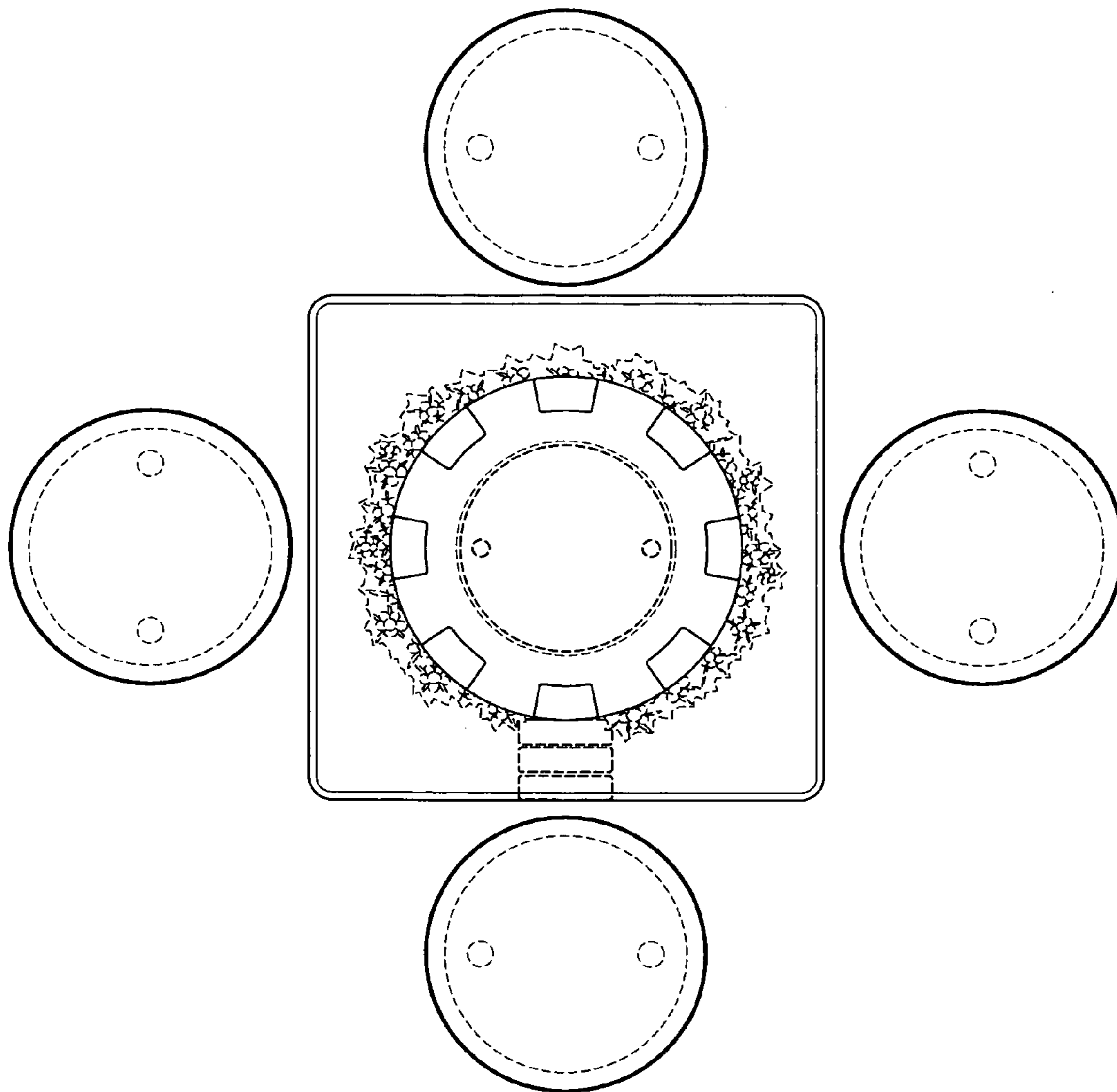

FIG. 10

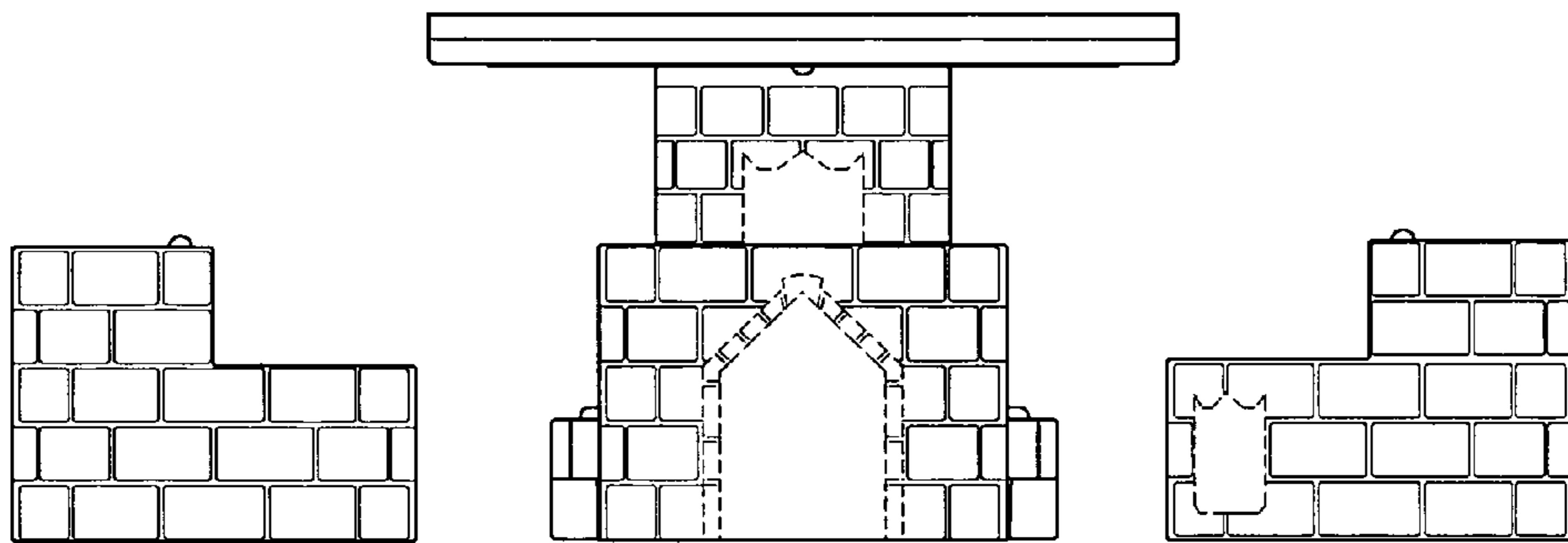

FIG. 11