



US00D631026S

(12) **United States Design Patent**  
**Kim et al.**

(10) **Patent No.:** **US D631,026 S**  
(45) **Date of Patent:** **\*\* Jan. 18, 2011**

(54) **MOBILE PHONE**

(75) Inventors: **Joon-Suh Kim**, Anyang-si (KR); **Naoki Shimada**, Ranchos Dominguez, CA (US); **Alex Chon**, Ranchos Dominguez, CA (US)

(73) Assignee: **Samsung Electronics Co., Ltd.**, Suwon-Si (KR)

(\*\*) Term: **14 Years**

(21) Appl. No.: **29/361,484**

(22) Filed: **May 12, 2010**

(30) **Foreign Application Priority Data**

Mar. 26, 2010 (KR) ..... 30-2010-0013347

(51) **LOC (9) Cl.** ..... **14-03**

(52) **U.S. Cl.** ..... **D14/138 AB; D14/138 AA**

(58) **Field of Classification Search** ..... D14/138 AA, D14/496, 341, 345, 346, 203.3, 203.4, 203.7, D14/138 AD, 138 R, 138 AB; 455/575.1, 455/556.2, 575.3; D21/517; 379/433.01, 379/433.04, 433.13

See application file for complete search history.

(56) **References Cited**

**U.S. PATENT DOCUMENTS**

- D317,782 S \* 6/1991 Haneda ..... D18/7
- D327,493 S \* 6/1992 Hayashi ..... D14/345
- 5,179,502 A \* 1/1993 Matsuda ..... 361/679.3
- D362,672 S \* 9/1995 Komuta et al. .... D14/345
- D377,341 S \* 1/1997 Imai et al. .... D14/343
- D409,987 S \* 5/1999 Okumura ..... D14/327
- 6,144,358 A \* 11/2000 Narayanaswamy et al. . 345/102
- 6,259,932 B1 \* 7/2001 Constien ..... 455/556.1
- 6,445,932 B1 \* 9/2002 Soini et al. .... 455/556.1
- D496,642 S \* 9/2004 Harries et al. .... D14/138 AA
- D538,252 S \* 3/2007 Joung ..... D14/138 AA
- D538,773 S \* 3/2007 Joung ..... D14/138 AA
- D542,257 S \* 5/2007 Ahn et al. .... D14/138 AA

- D542,260 S \* 5/2007 Lee ..... D14/138 AA
- D545,792 S \* 7/2007 Kim et al. .... D14/138 AA
- D552,070 S \* 10/2007 Park ..... D14/138 AB
- D552,584 S \* 10/2007 Lee ..... D14/138 AA

(Continued)

**OTHER PUBLICATIONS**

Samsung P300 telephone, announced 4<sup>th</sup> quarter 2003, [online], [site visited Aug. 17, 2010]. Available from Internet, <URL: <http://www.gsmarena.com>>.\*

(Continued)

*Primary Examiner*—Jeffrey D Asch  
(74) *Attorney, Agent, or Firm*—Staas & Halsey LLP

(57) **CLAIM**

The ornamental design for a mobile phone, as shown and described.

**DESCRIPTION**

FIG. 1 is a front perspective view of a mobile phone;  
FIG. 2 is a front view of the mobile phone of FIG. 1;  
FIG. 3 is a rear view of the mobile phone of FIG. 1;  
FIG. 4 is a left-side view of the mobile phone of FIG. 1;  
FIG. 5 is a right-side view of the mobile phone of FIG. 1;  
FIG. 6 is a top plan view of the mobile phone of FIG. 1;  
FIG. 7 is a bottom plan view of the mobile phone of FIG. 1;  
and,  
FIG. 8 is an open front perspective view of the mobile phone of FIG. 1.

**1 Claim, 5 Drawing Sheets**

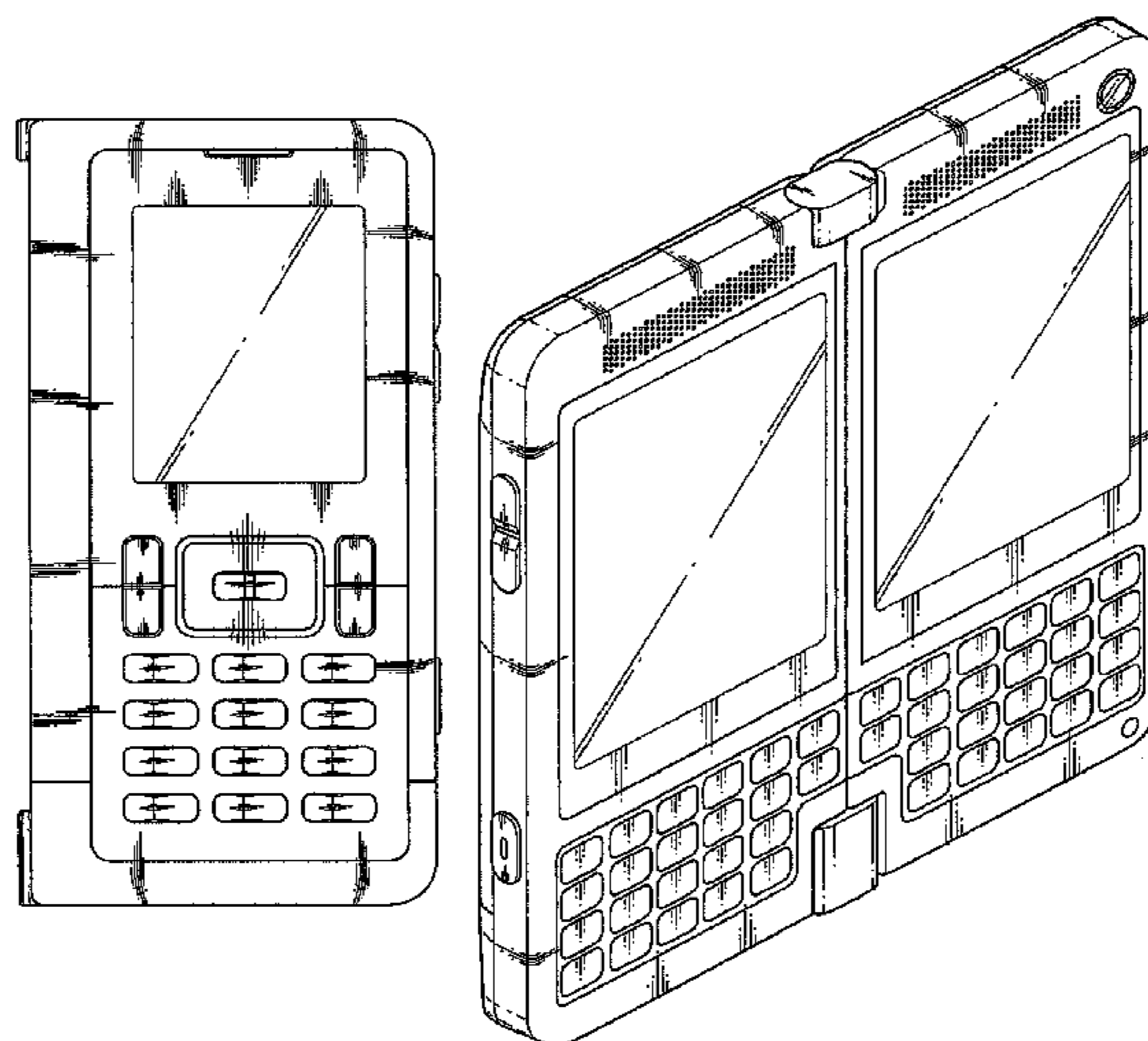

U.S. PATENT DOCUMENTS

D557,674 S \* 12/2007 Lee et al. .... D14/138 AB  
D560,642 S \* 1/2008 Yun et al. .... D14/138 AA  
D565,015 S \* 3/2008 Kim et al. .... D14/138 AA  
D565,017 S \* 3/2008 Kim et al. .... D14/138 AA  
D572,692 S \* 7/2008 Kim et al. .... D14/138 AA  
D583,343 S \* 12/2008 Lee et al. .... D14/138 AA  
D591,255 S \* 4/2009 Lee et al. .... D14/138 AA  
D601,992 S \* 10/2009 Choi et al. .... D14/138 AB  
D603,363 S \* 11/2009 Choi et al. .... D14/138 AB  
D604,709 S \* 11/2009 Koigo ..... D14/138 AA  
D607,864 S \* 1/2010 Zhou et al. .... D14/138 AA  
D608,321 S \* 1/2010 Husgafvel ..... D14/138 AA  
D615,954 S \* 5/2010 Kim et al. .... D14/138 AA  
D616,406 S \* 5/2010 Du et al. .... D14/138 AA  
D617,750 S \* 6/2010 Chen et al. .... D14/138 AA  
D617,751 S \* 6/2010 Lee et al. .... D14/138 AA

7,778,665 B2\* 8/2010 Yau et al. .... 455/556.2

OTHER PUBLICATIONS

Nokia E90 telephone, announced Feb. 2007, [online], [site visited Aug. 17, 2010]. Available from Internet, <URL: <http://www.gsmarena.com>>.\*

LG C2600 telephone, announced Dec. 2006, [online], [site visited Aug. 17, 2010]. Available from Internet, <URL: <http://www.gsmarena.com>>.\*

Acer DX650 telephone, announced Jun. 2009, [online], [site visited Aug. 17, 2010]. Available from Internet, <URL: <http://www.gsmarena.com>>.\*

Asus M930 telephone, announced Feb. 2008, [online], [site visited Aug. 17, 2010]. Available from Internet, <URL: <http://www.gsmarena.com>>.\*

\* cited by examiner

# FIG. 1

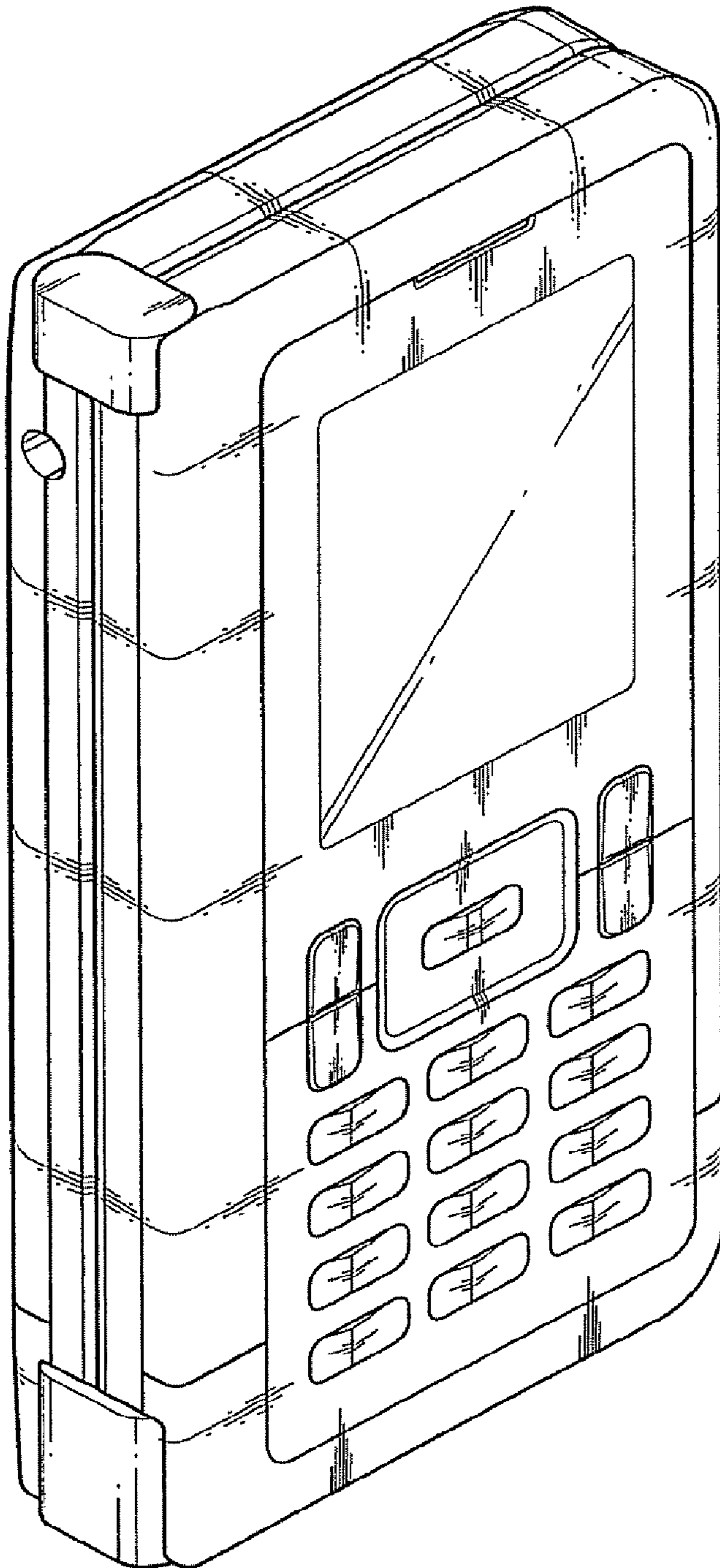

FIG.2

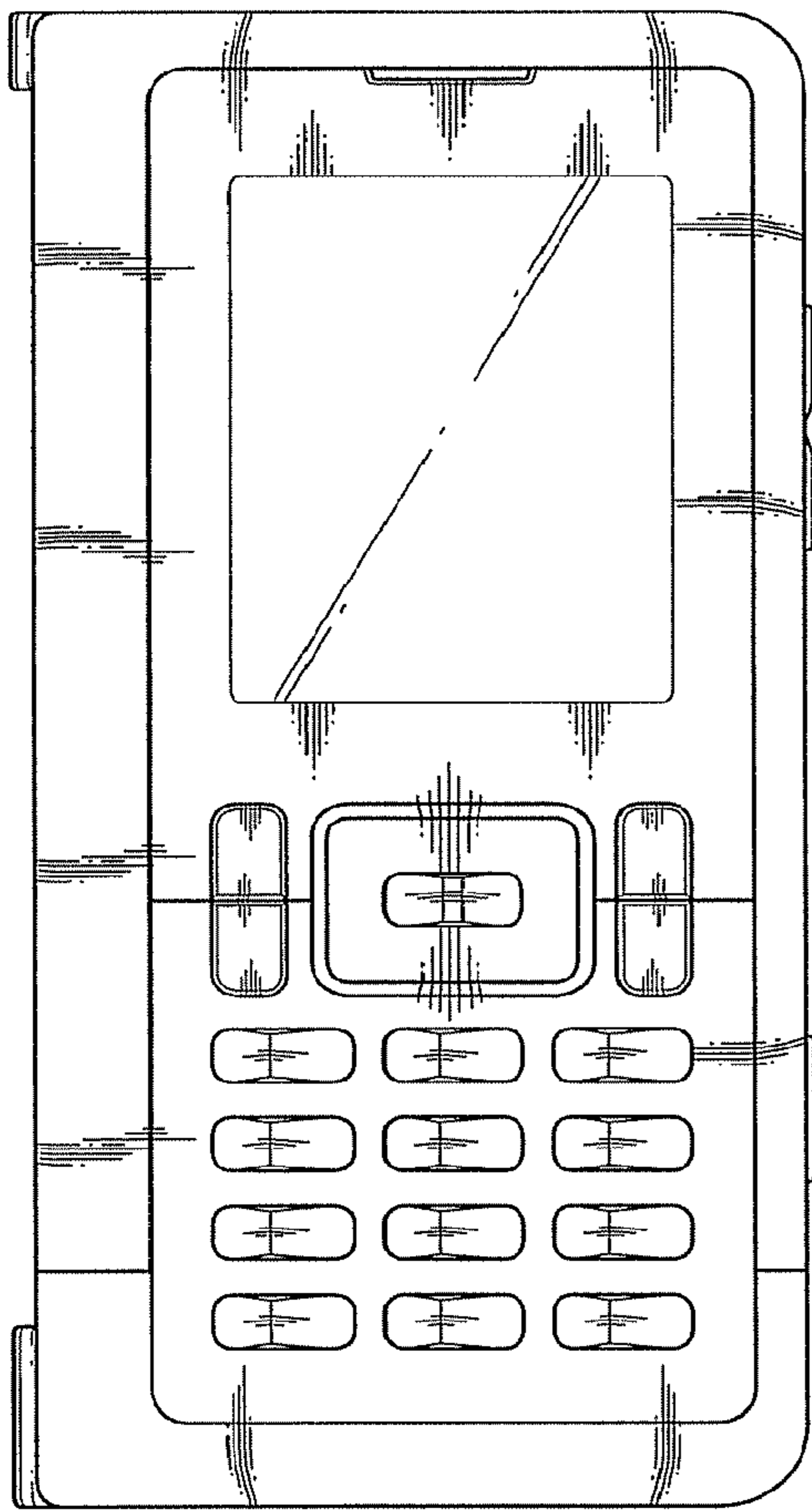
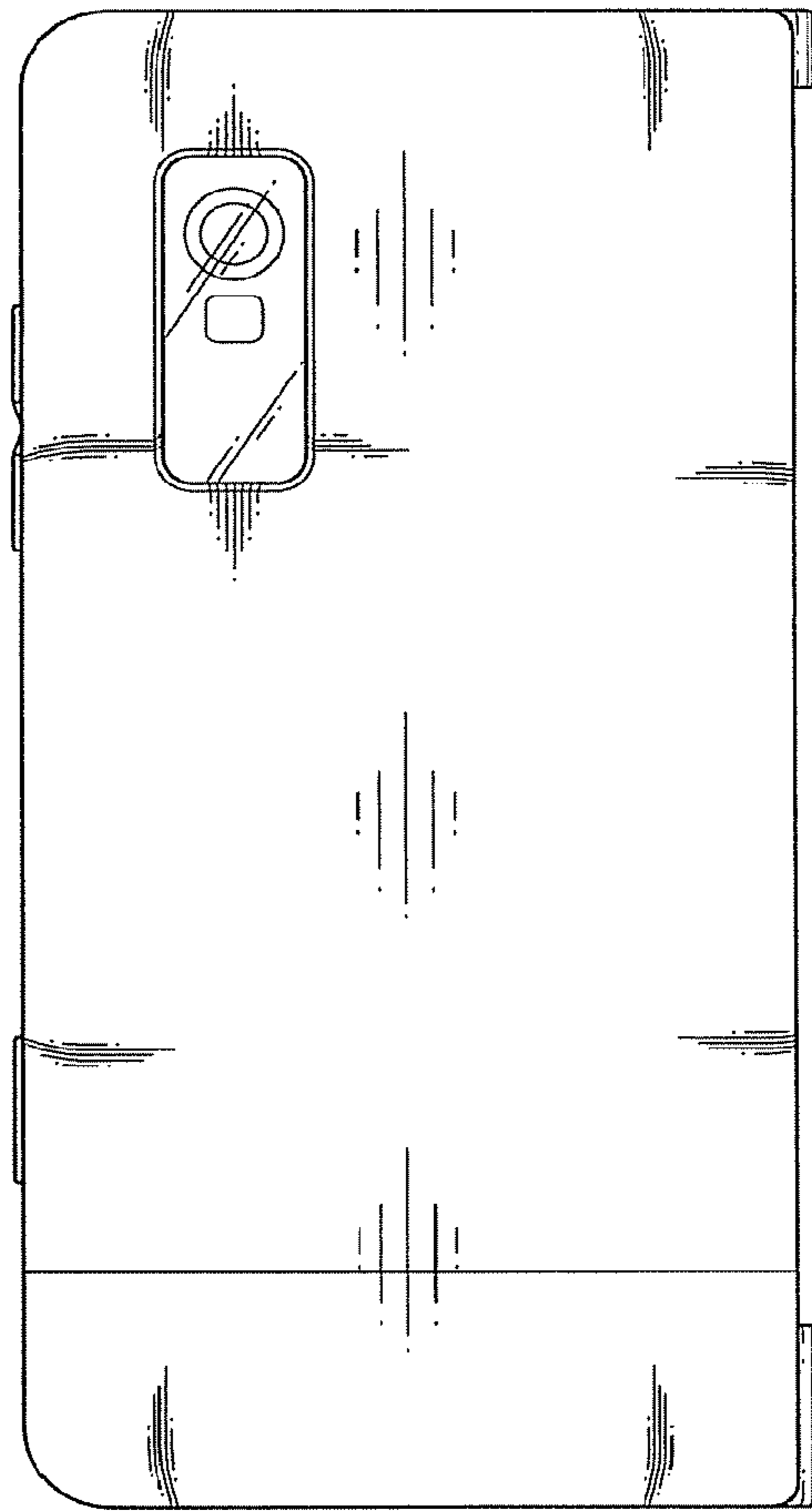
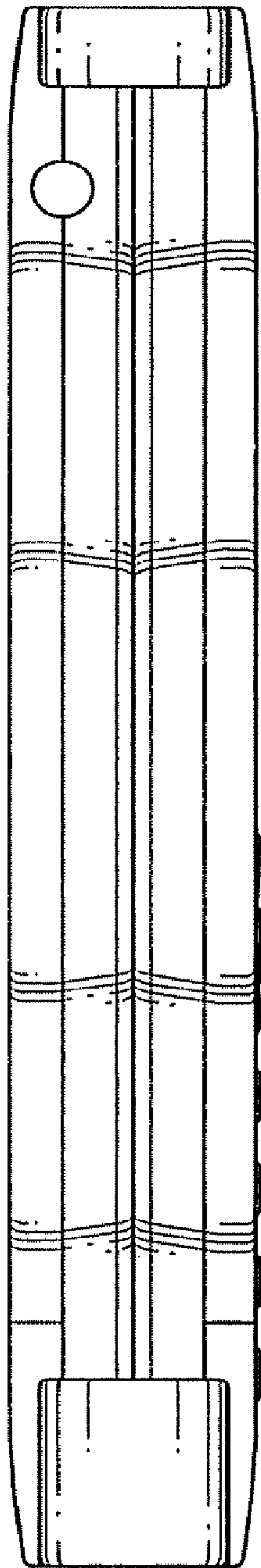

FIG.3



**FIG.4**



**FIG.5**

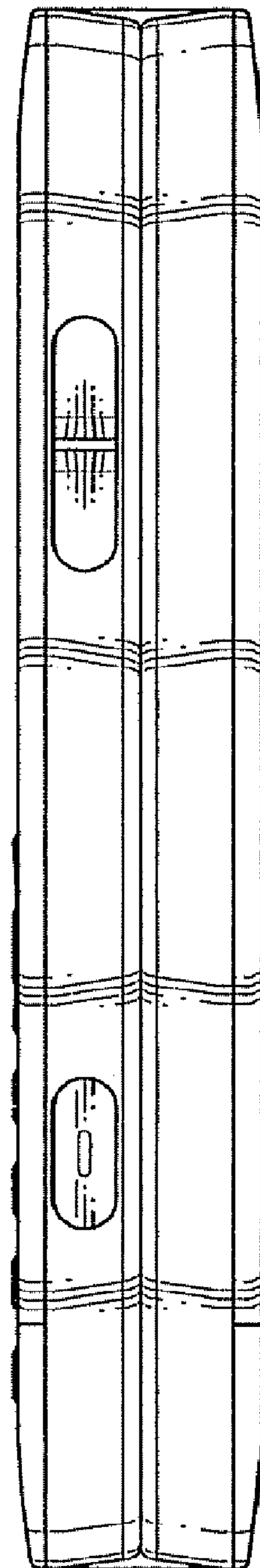

# FIG. 6

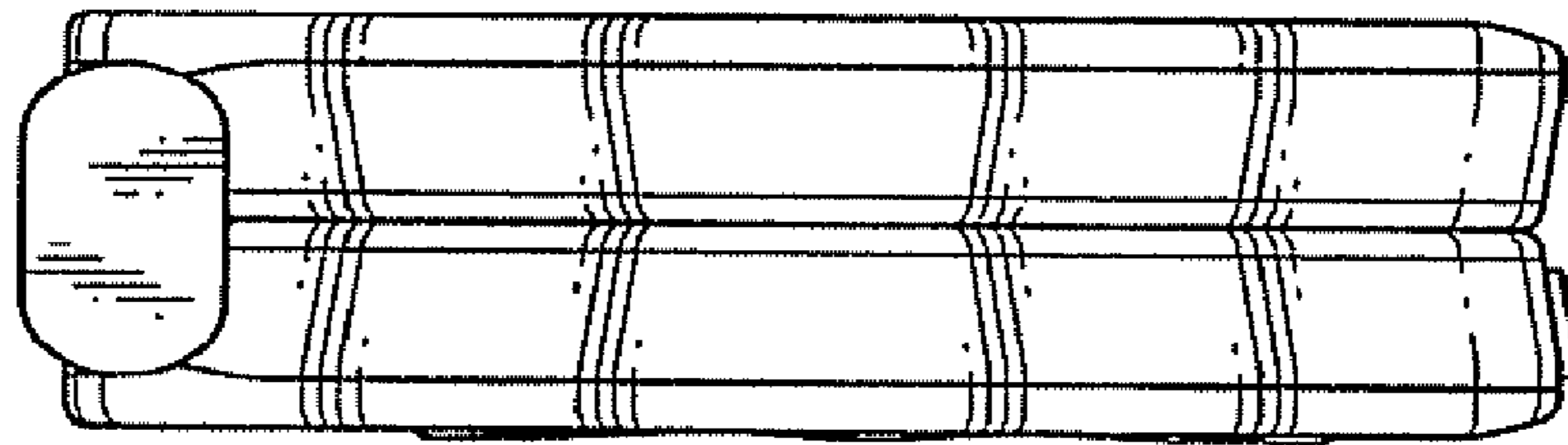

# FIG. 7

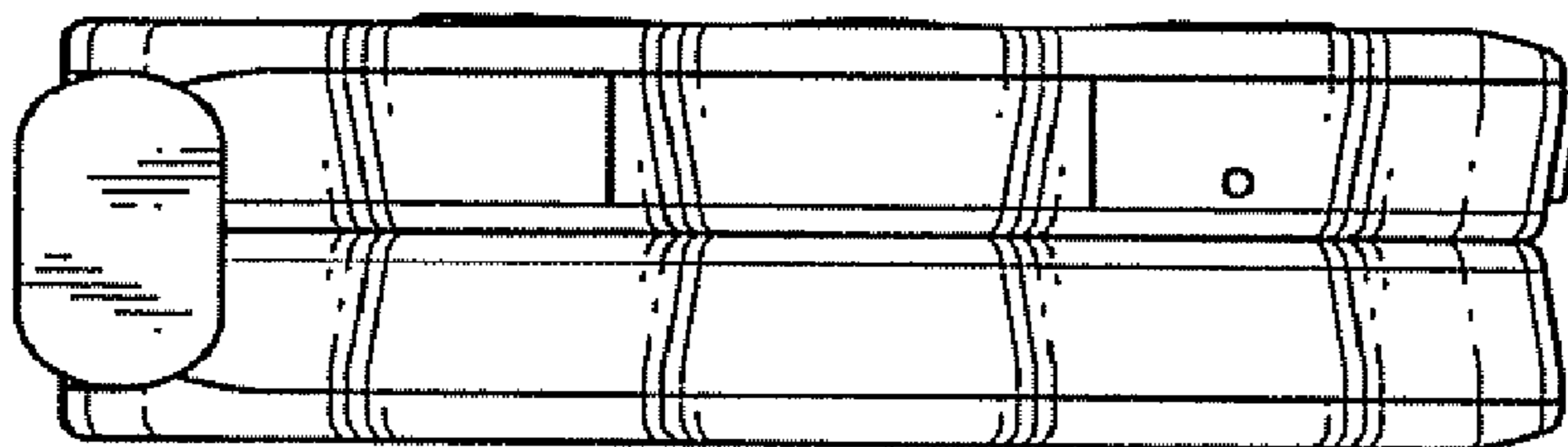

FIG. 8

