



US00D631008S

(12) **United States Design Patent**
Kuroda et al.

(10) **Patent No.:** **US D631,008 S**

(45) **Date of Patent:** **** Jan. 18, 2011**

(54) **CHARGER FOR COMPUTER**

(75) Inventors: **Hiroyuki Kuroda**, Ishikawa (JP); **Shuji Hashimoto**, Ishikawa (JP)

(73) Assignee: **PFU Limited**, Kahoku-shi (JP)

(**) Term: **14 Years**

(21) Appl. No.: **29/361,629**

(22) Filed: **May 13, 2010**

(30) **Foreign Application Priority Data**

Nov. 17, 2009 (JP) 2009-026843

(51) **LOC (9) Cl.** **13-02**

(52) **U.S. Cl.** **D13/108**

(58) **Field of Classification Search** D13/107–110,
D13/118–119, 184; D14/251, 253, 432,
D14/434, 435.1; 320/107–115

See application file for complete search history.

(56) **References Cited**

U.S. PATENT DOCUMENTS

- D351,133 S * 10/1994 Jungels-Butler et al. ... D13/108
- D368,704 S * 4/1996 Tanaka D14/434
- D411,835 S * 7/1999 Mizusugi et al. D14/434
- D465,532 S * 11/2002 Hussaini et al. D21/333
- D523,847 S * 6/2006 Naruki D14/224.1
- D525,935 S * 8/2006 Hussaini et al. D13/108
- D532,366 S * 11/2006 Koizumi D13/108
- D540,327 S * 4/2007 Wong et al. D14/434
- D546,760 S * 7/2007 Aguilar D13/108
- D552,611 S * 10/2007 Hagiwara et al. D14/434

- D557,207 S * 12/2007 Aguilar D13/108
- D577,665 S * 9/2008 Kim et al. D13/107
- D598,453 S * 8/2009 Solomon et al. D14/434
- D618,689 S * 6/2010 Shimizu D14/434
- D623,132 S * 9/2010 Yano D13/108

* cited by examiner

Primary Examiner—Rosemary K Tarcza

(74) *Attorney, Agent, or Firm*—RatnerPrestia

(57) **CLAIM**

The ornamental design for a charger for computer, as shown and described.

DESCRIPTION

FIG. 1 is a perspective view of a charger for computer showing our new design;

FIG. 2 is a front view thereof;

FIG. 3 is a rear view thereof;

FIG. 4 is a right side view thereof;

FIG. 5 is a left side view thereof;

FIG. 6 is a top plan view thereof;

FIG. 7 is a bottom plan view thereof;

FIG. 8 is a reference perspective view thereof showing docking a computer; and,

FIG. 9 is another reference perspective view thereof showing the chargers with computers with legs turned inside.

The broken lines shown in the drawings are included for the purpose of illustrating environmental structure and form no part of the claimed design.

1 Claim, 4 Drawing Sheets

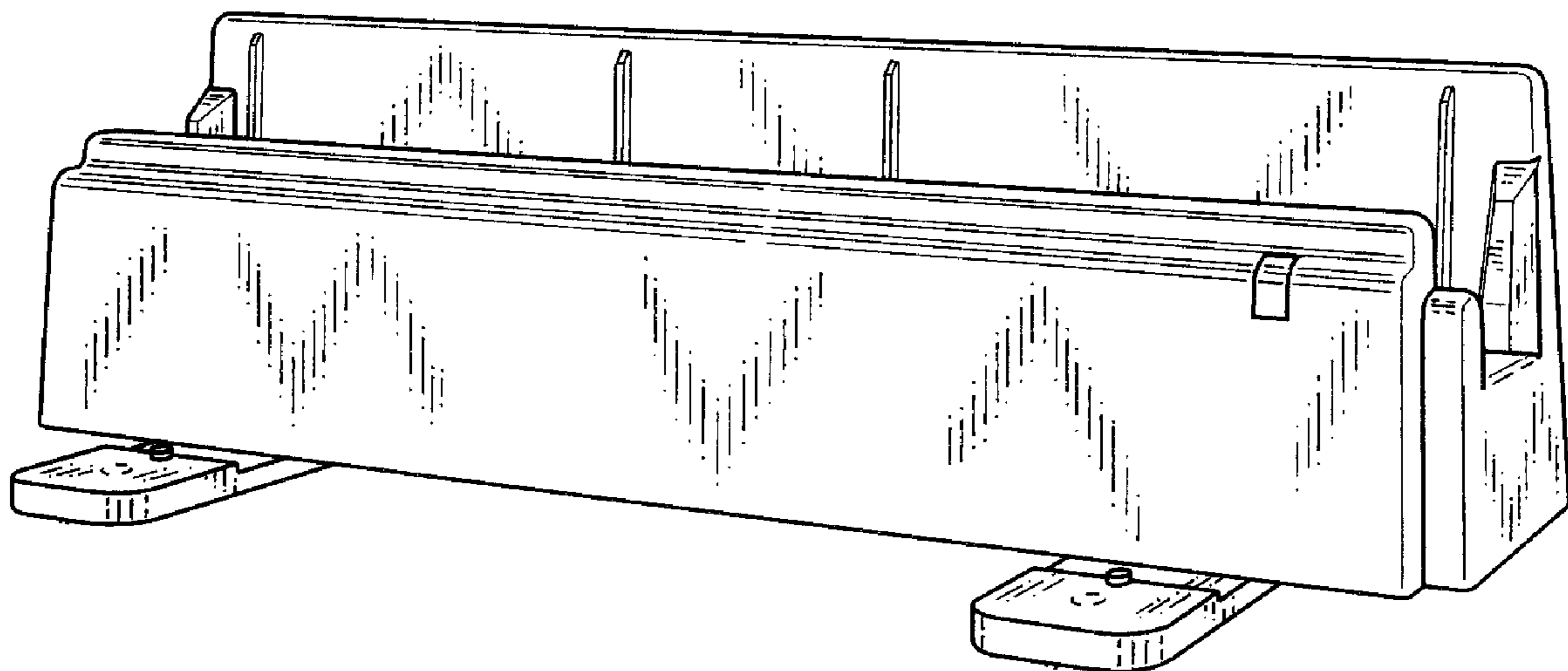

Fig.1

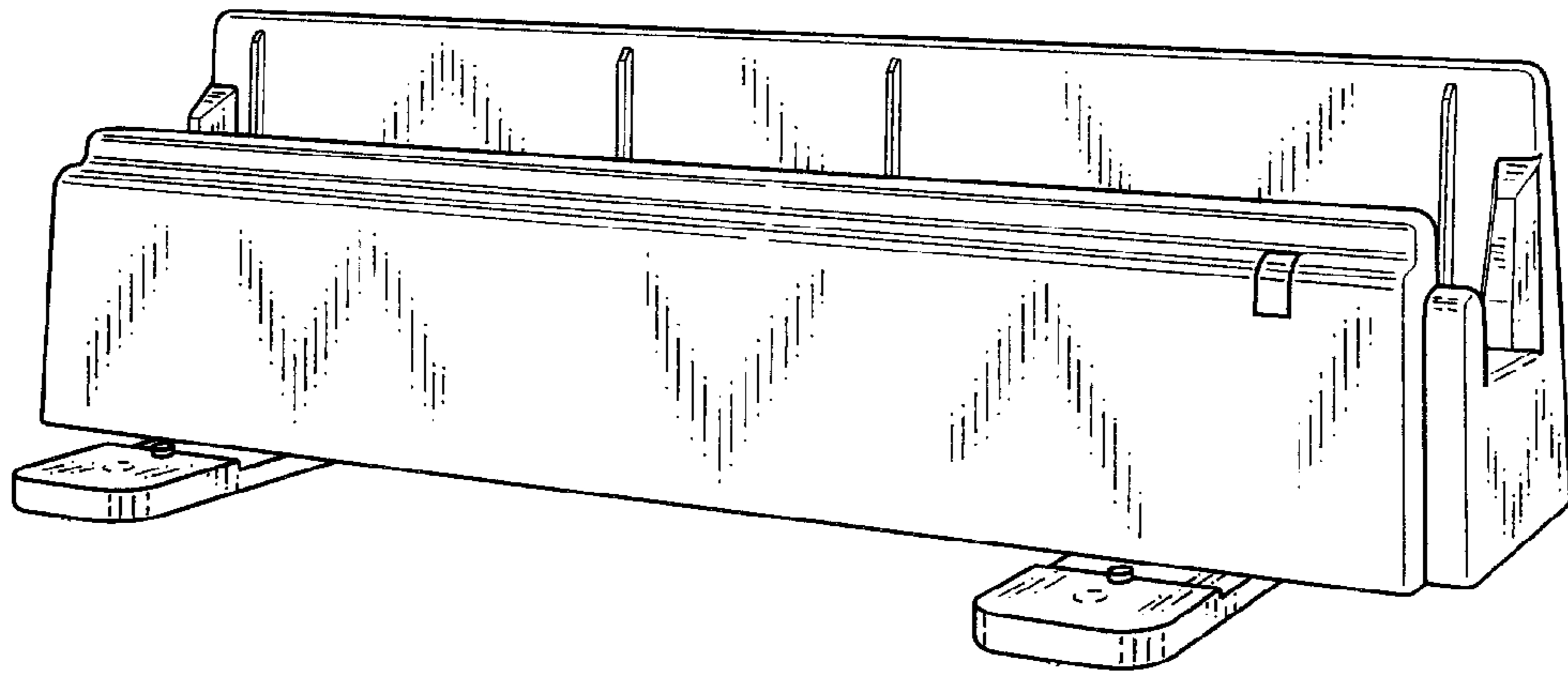

Fig.2

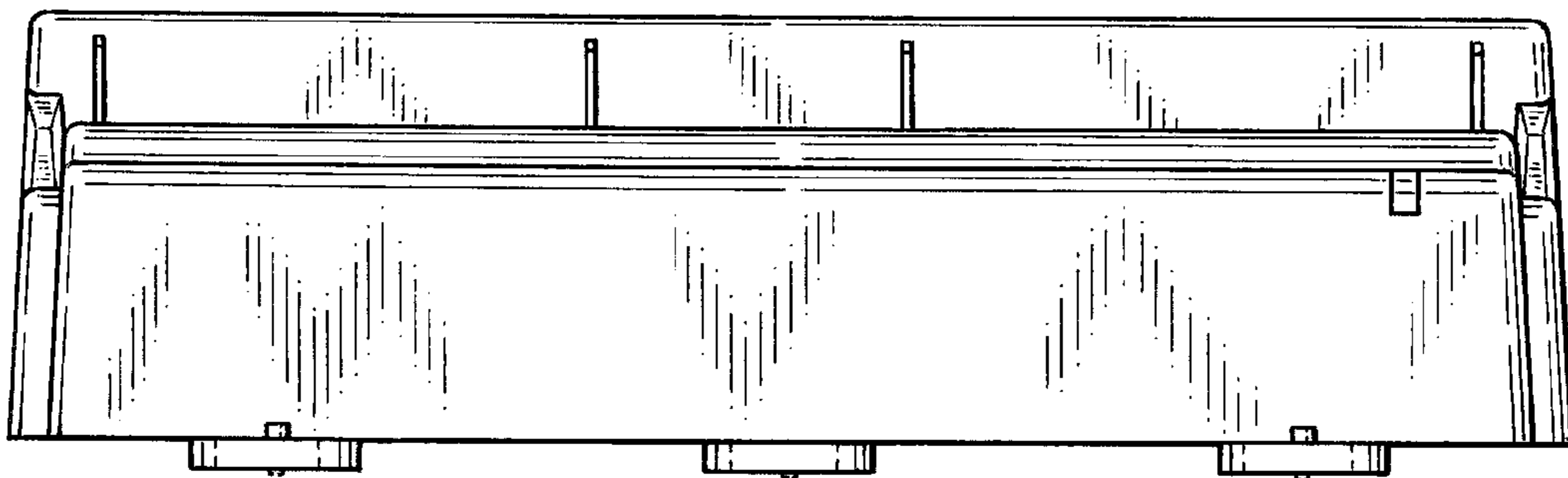

Fig.3

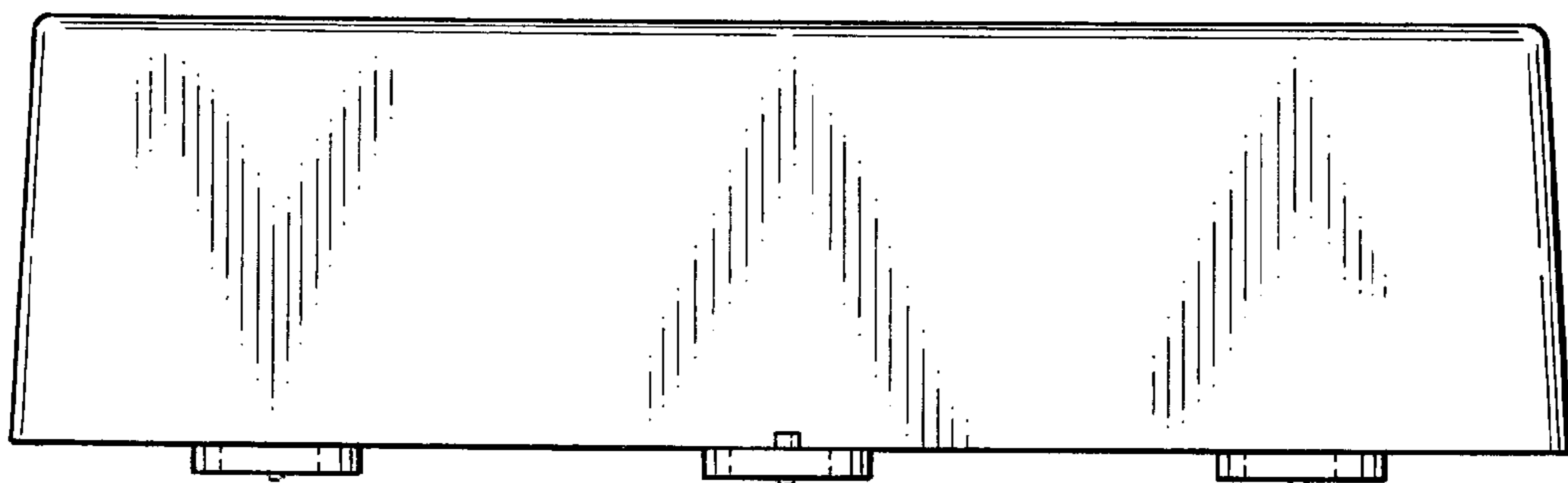

Fig.4

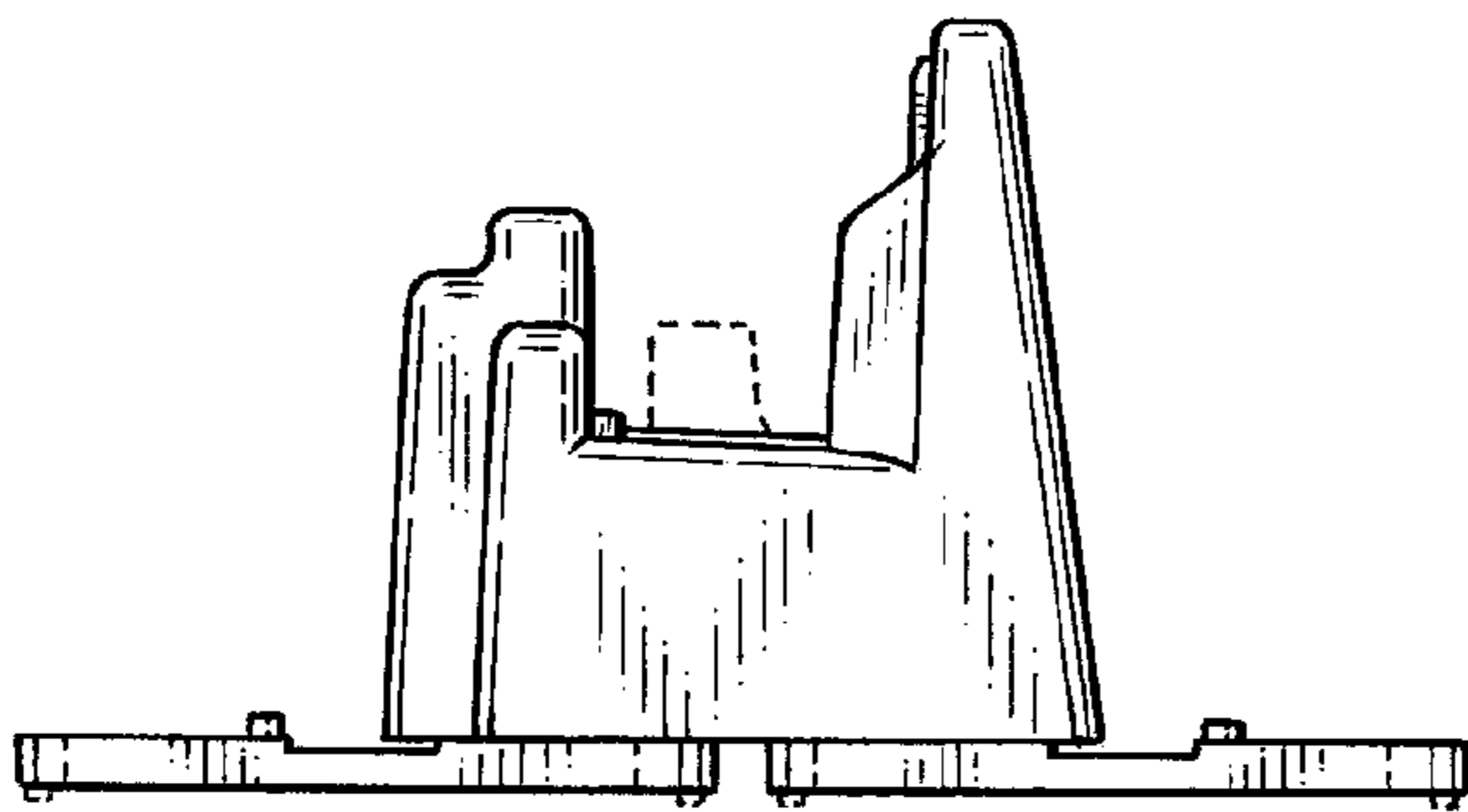

Fig.5

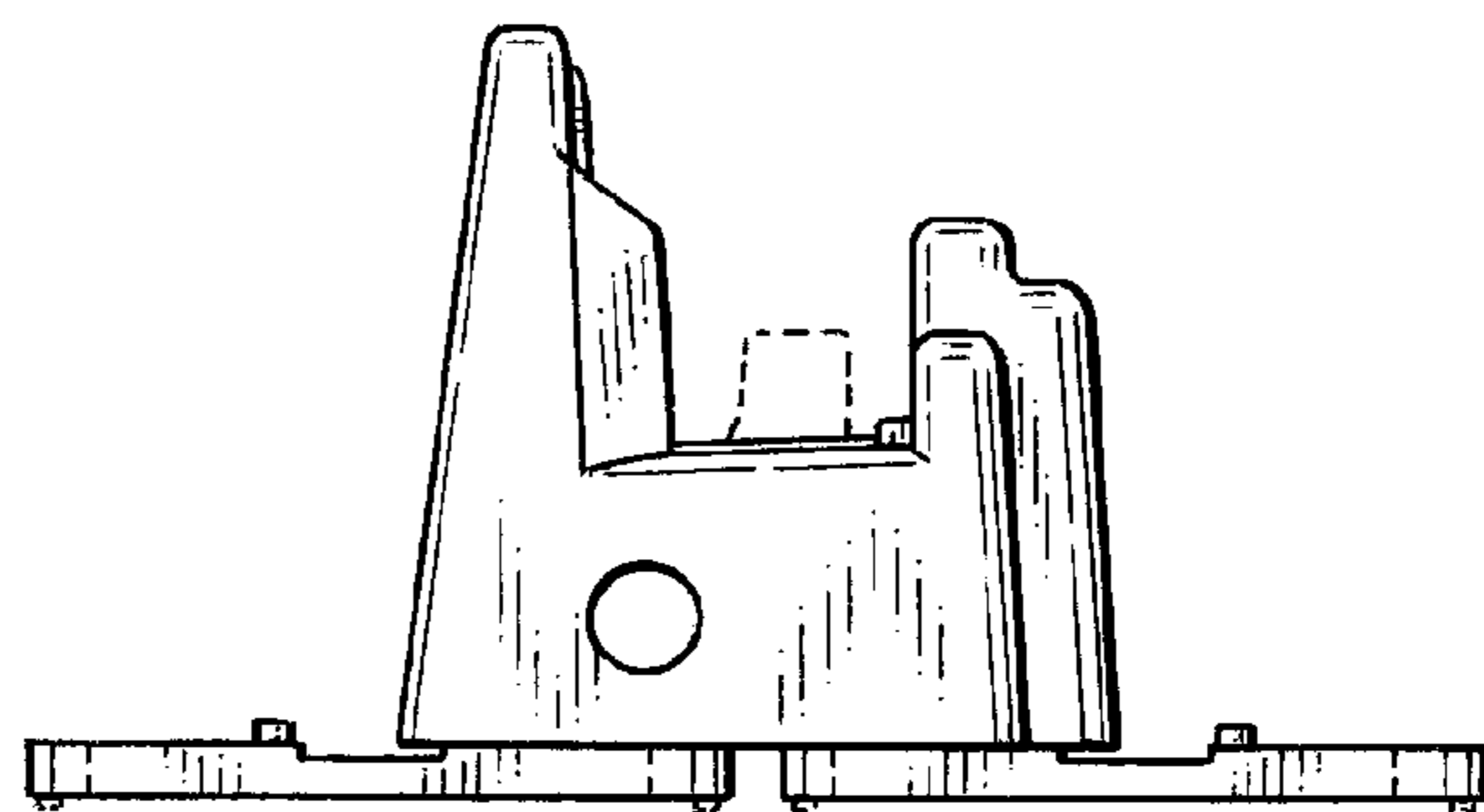

Fig.6

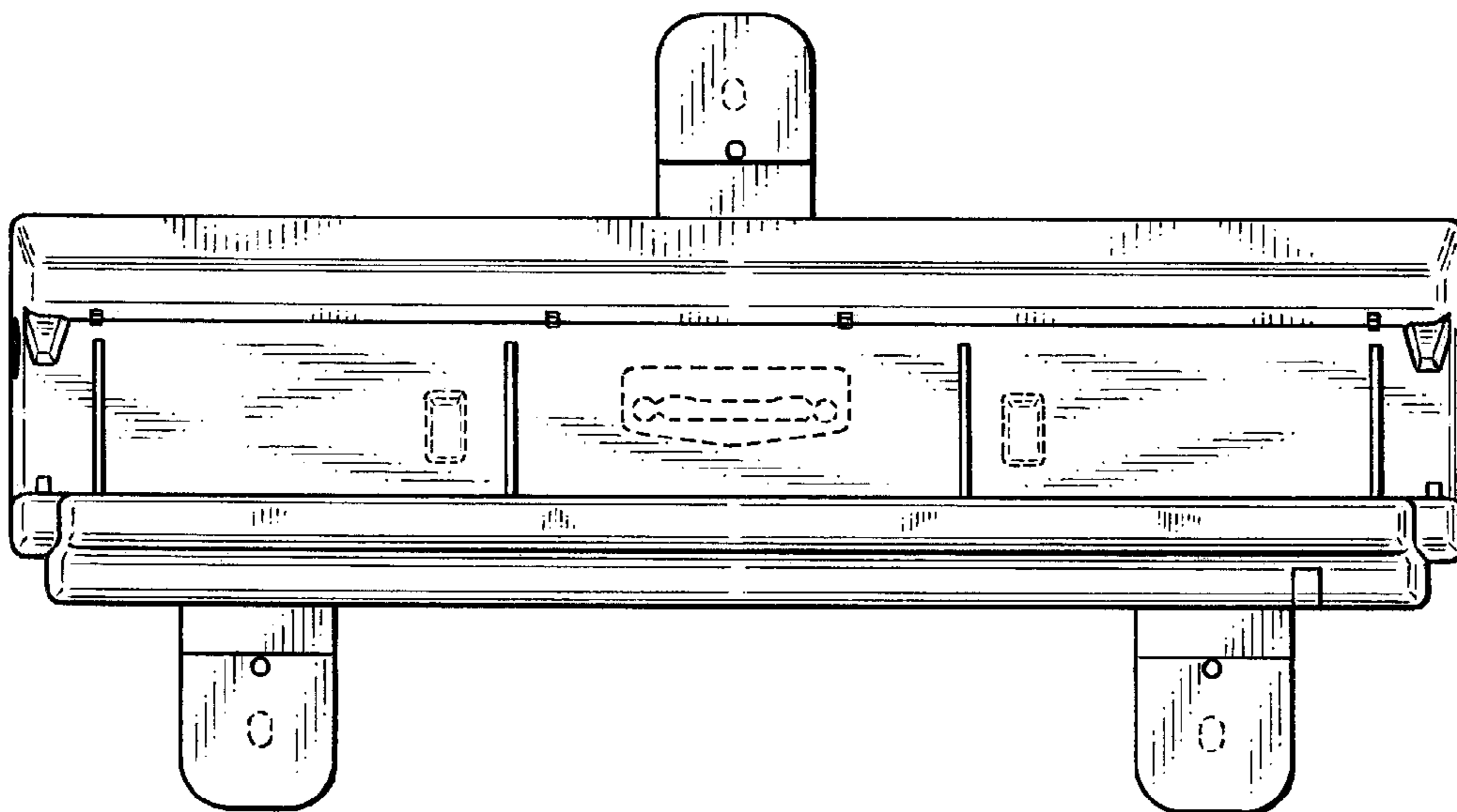

Fig. 7

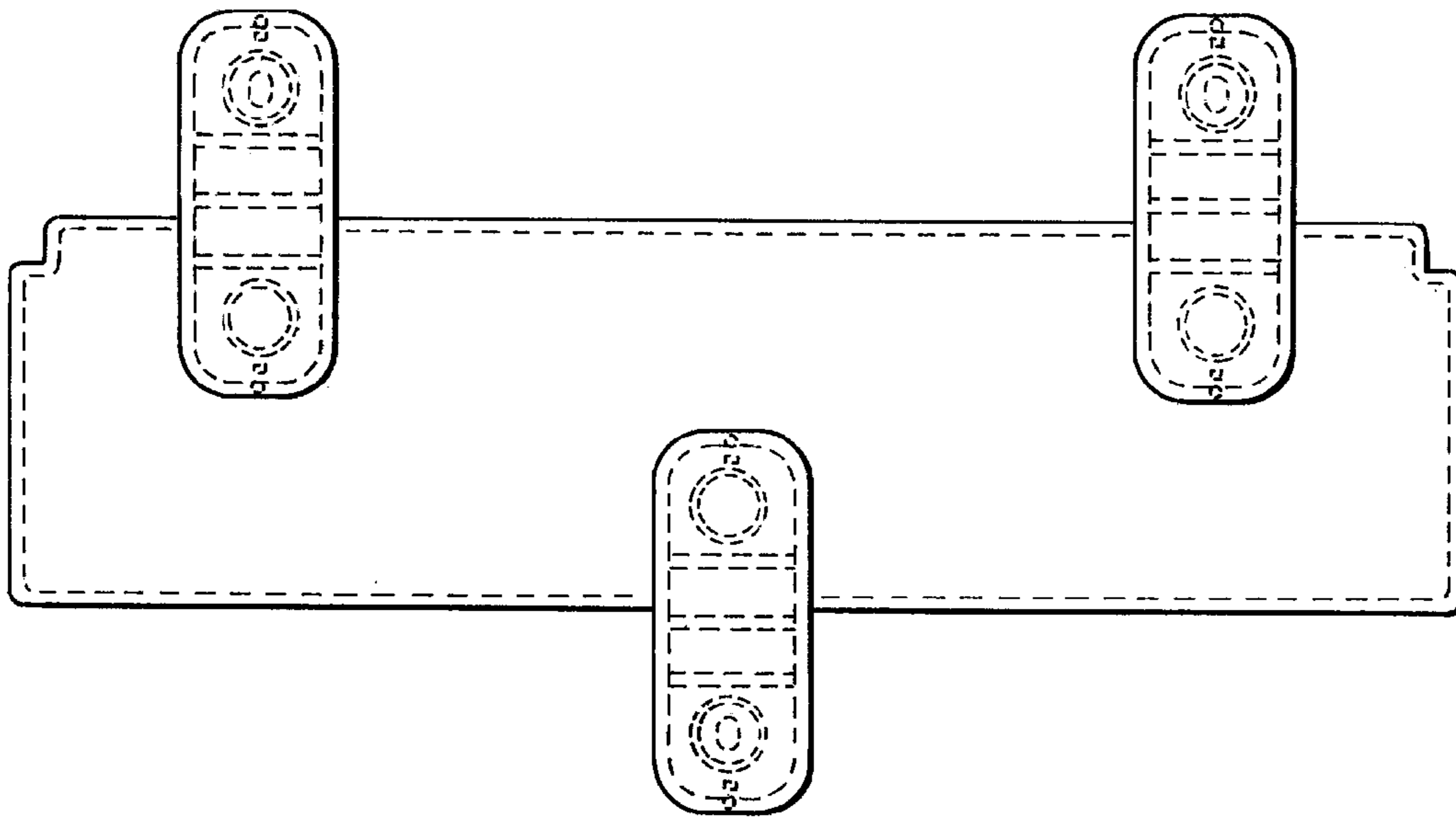

Fig. 8

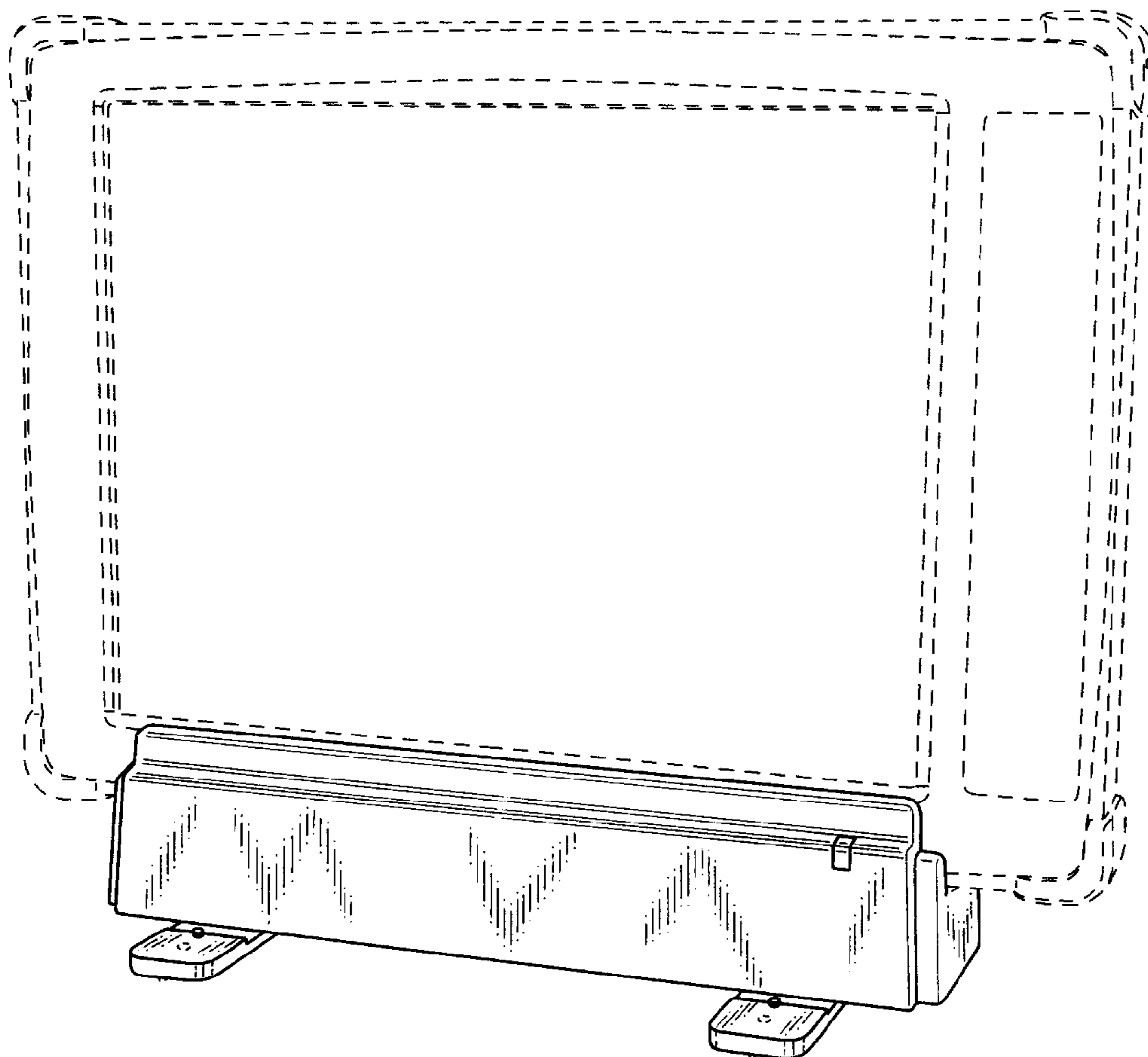

Fig.9

